

Part Number: KB817

**GENERAL PURPOSE
HIGH ISOLATION VOLTAGE
SINGLE TRANSISTOR TYPE
PHOTOCOUPLER SERIES**

FEATURES

- 1.High isolation voltage between input and output (Viso=5000 Vrms).
- 2.Compact dual-in-line package
KB817:1-channel type
- 3.Recognized by UL and CUL, file NO.E225308.
- 4.Approved by VDE 0884 Teil2(NO:40006364)
(Creepage distance between input and output:7mm or more).
- 5.RoHS compliant.

DESCRIPTION

- 1.The KB817 (1-channel) is optically coupled isolators containing a GaAS light emitting diode and an NPN silicon phototransistor.
- 2.The lead pitch is 2.54mm.
- 3.Solid insulation thickness between emitting diode and output phototransistor: ≥ 0.6 mm.

APPLICATIONS

- 1.Computer terminals.
- 2.Registers,copiers,automatic vending machines.
- 3.System appliances, measuring instruments.
- 4.Programmable logic controller.
- 5.Signal transmission between circuits of different potentials and impedances.



Part Number: KB817

***PACKAGE DIMENSIONS (UNIT:mm)**
DIP Type

TOLERANCE : $\pm 0.5[\pm 0.02]$ UNLESS OTHERWISE NOTED.

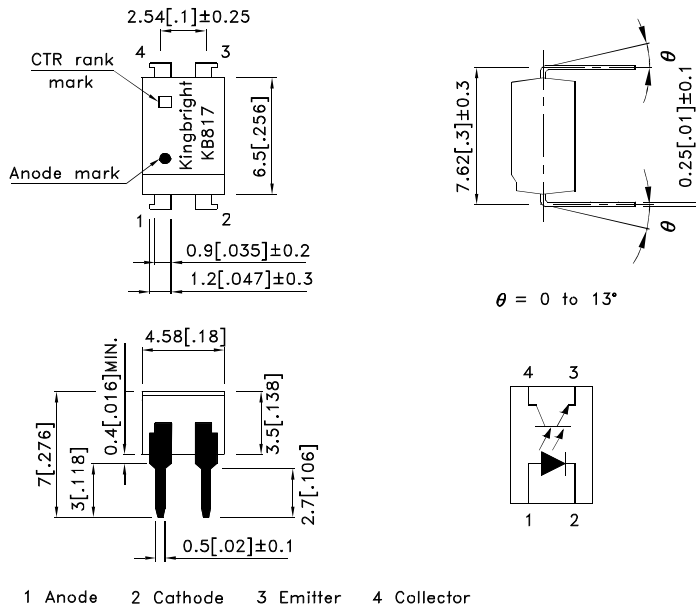

***Absolute Maximum Ratings (Ta=25°C)**

Parameter		Symbol	Rating	Unit
Input	Forward current	I_F	50	mA
	Reverse voltage	V_R	6	V
	Power dissipation	P	70	mW
Output	Collector-emitter voltage	V_{CEO}	35	V
	Emitter-collector voltage	V_{ECO}	6	V
	Collector current	I_C	50	mA
	Collector power dissipation	P_C	150	mW
Total power dissipation		P_{tot}	200	mW
*1 Isolation voltage		Viso	5000	Vrms
Operating temperature		Topr	-30~+100	°C
Storage temperature		Tstg	-55~+125	°C
*2 Soldering temperature		Tsol	260	°C

*1 40 to 60% RH, AC for 1 minute.

*2 For 10 seconds.

Part Number: KB817

*Electro-optical Characteristics

Parameter		Symbol	Conditions	Min.	Typ.	Max.	Unit
Input	Forward voltage	V_F	$I_F=20\text{mA}$	—	1.2	1.4	V
	Peak forward voltage	V_{FM}	$I_{FM}=0.5\text{A}$	—	—	3.0	V
	Reverse current	I_R	$V_R=4\text{V}$	—	—	10	μA
Output	Collector dark current	I_{CEO}	$V_{CE}=20\text{V}, I_F=0\text{mA}$	—	—	10^{-7}	A
Transfer characteristics	*1 Current transfer ratio	CTR	$I_F=5\text{mA}, V_{CE}=5\text{V}$	50	—	600	%
	Collector-emitter saturation voltage	$V_{CE(sat)}$	$I_F=20\text{mA}, I_C=1\text{mA}$	—	0.1	0.2	V
	Cut-off frequency	f_c	$V_{CE}=5\text{V}, I_C=2\text{mA}$ $R_L=100\Omega, -3\text{dB}$	—	80	—	KHz
	Response time	Rise time	t_r	$V_{CE}=2\text{V}, I_C=2\text{mA}$ $R_L=100\Omega$	—	4	18
Fall time		t_f	—		3	18	μs

*1 Classification table of current transfer ratio is shown below.

$$\text{CTR} = \frac{I_C}{I_F} \times 100\%$$

Model No.	Rank mark	CTR(%)
KB817L	L	50 to 100
KB817A	A	80 to 160
KB817B	B	130 to 260
KB817C	C	200 to 400
KB817D	D	300 to 600
KB817AB	A or B	80 to 260
KB817BC	B or C	130 to 400
KB817CD	C or D	200 to 600
KB817AC	A,B or C	80 to 400
KB817BD	B,C or D	130 to 600
KB817AD	A,B,C or D	80 to 600
KB817	L,A,B,C,D or No mark	50 to 600

Part Number: KB817

Fig. 1 Current Transfer Ratio vs. Forward Current

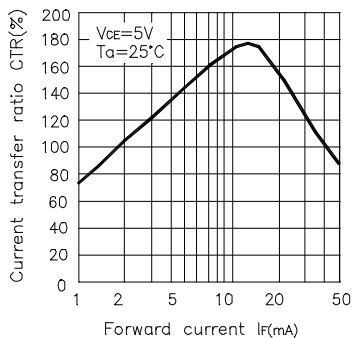

Fig. 2 Forward Current vs. Forward voltage

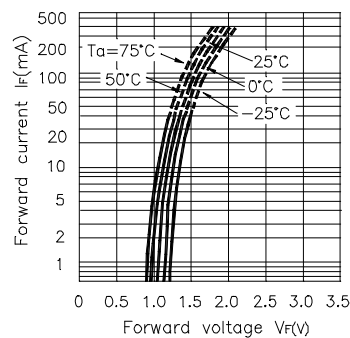

Fig. 3 Collector Current vs. Collector-emitter Voltage

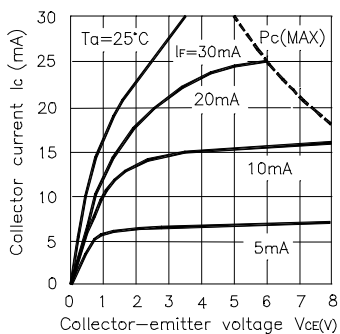

Fig. 4 Relative Current Transfer Ratio vs. Ambient Temperature

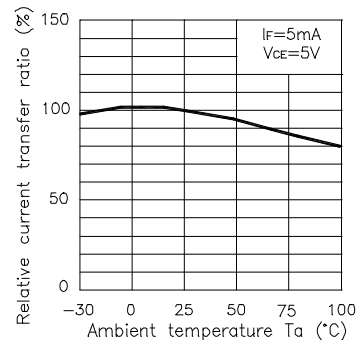

Fig. 5 Collector-emitter Saturation Voltage vs. Ambient Temperature

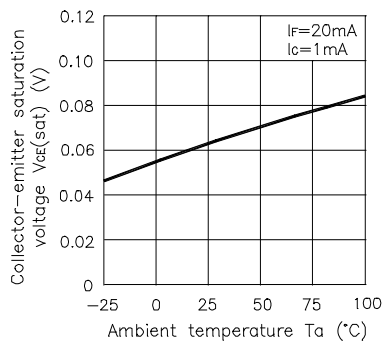
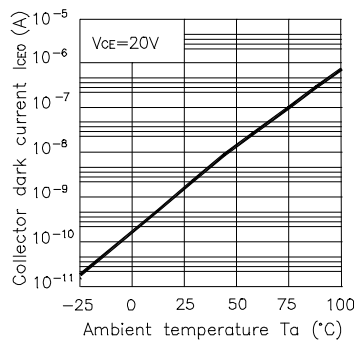

Fig. 6 Collector Dark Current vs. Ambient Temperature



Part Number: KB817

Fig. 7 Forward Current vs. Ambient Temperature

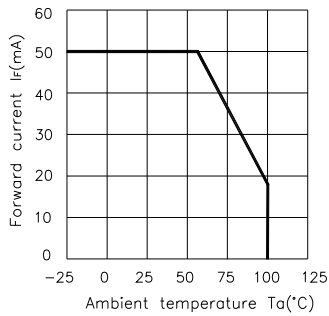

Fig. 8 Collector Power Dissipation vs. Ambient Temperature

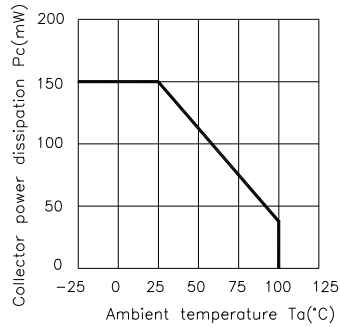
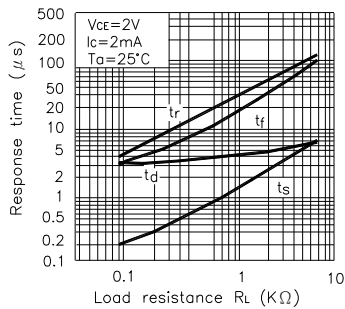

Fig. 9 Response Time vs. Load Resistance



Test Circuit for Response Time

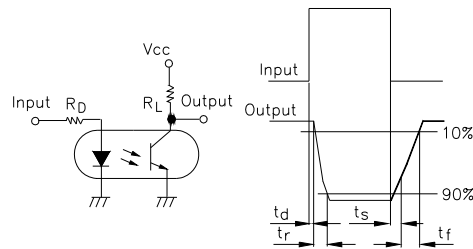
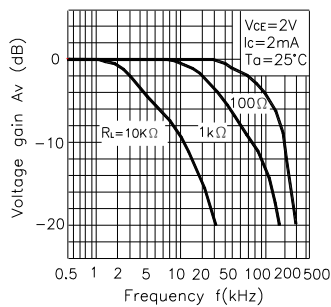

Fig. 10 Frequency Response



Test Circuit for Frequency Response

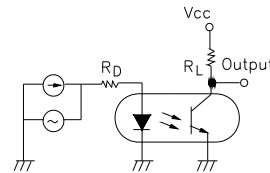
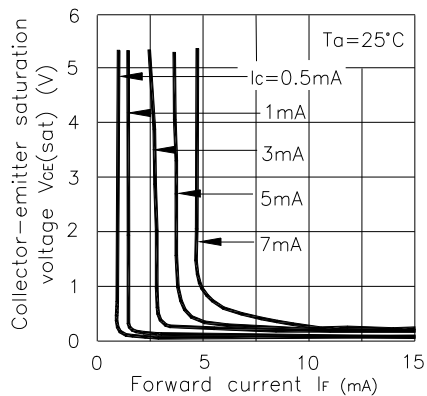

Fig. 11 Collector-emitter Saturation Voltage vs. Forward Current



*NOTES ON HANDLING

1.Recommended soldering conditions (Dip soldering)

(1) Dip soldering

Temperature	260 °C or below (molten solder temperature)
Time	Less than 10 seconds.
Cycle	One cycle allowed to be dipped in solder including plastic mold portion.
Flux	Rosin flux containing small amount of chorine (The flux with a maximum chlorine content of 0.2 Wt % is recommended.)

(2) Cautions

Fluxes
Avoid removing the residual flux with freon-based and chlorine-based cleaning solvent.

2.Cautions regarding noise

Be aware that power is suddenly into the componment any surge current may cause damage happen, even if the voltage is within the absolute maximum ratings.

Part Number: KB817

CAUTION

Within this device there exists GaAs (Gallium Arsenide) material which is a harmful substance if ingested.

GaAs dust and fumes are toxic. Do not break, cut or pulverize the product, or use chemicals to dissolve them.

RESTRICTIONS ON PRODUCT USE

- The information in this document is subject to change without notice. Before using this document, please confirm that this is the latest version. Not all devices / types available in every country.
- We are mention about our product quality stability, semiconductor devices in general can malfunction or fail due to their inherent electrical sensitivity and vulnerability to physical stress. It is the responsibility of the buyer, when utilizing KINGBRIGHT products, to observe standards of safety, and to a avoid situations in which a malfunction or failure of a KINGBRIGHT product could cause loss of human life, bodily injury or damage to property. In developing your designs, please ensure that KINGBRIGHT products are used within specified operating ranges as set forth in the most recent products specifications.

Part Number: KB817

Dimension of Tube

TOLERANCE : $\pm 0.4[\pm 0.012]$ UNLESS OTHERWISE NOTED.
Unit:mm

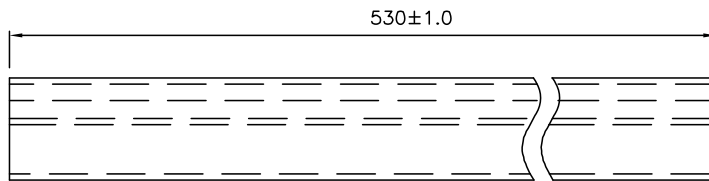
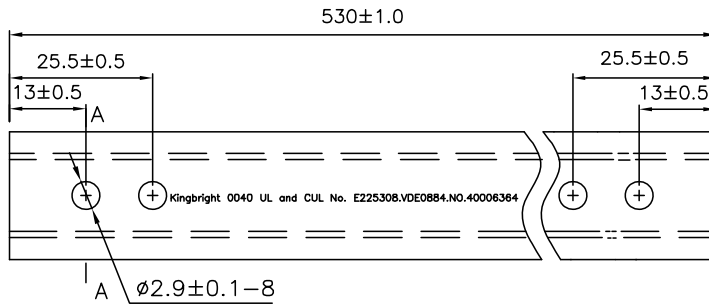

A-A Side view

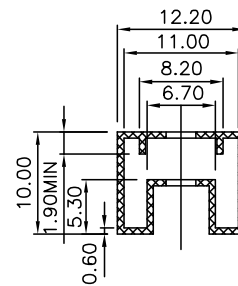

Dimension of Carton

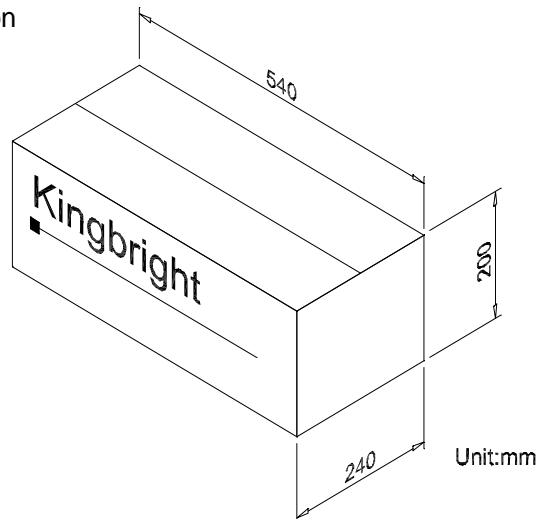



*ORDERING INFORMATION

Part Number	Package	Package Style
KB817	4-pin DIP	100pcs/each tube

Part Number: KB817

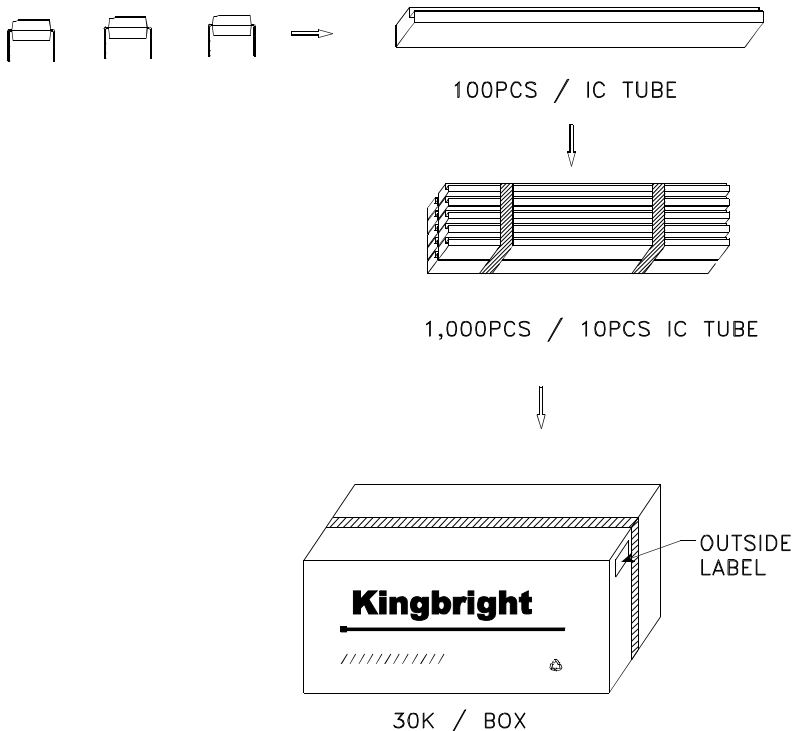
PACKING & LABEL SPECIFICATIONS



<h1>Kingbright</h1>	
P/NO: KB817	
QTY: 1,000 pcs	Q.C. Q C XX XX XXXX PASSED
S/N: XXXX	
CODE: XXX	
LOT NO:	
 XXXXXXXXXXXXXXXXXXXX	
RoHS Compliant	