

# Polar™ Power MOSFET

N-Channel Enhancement Mode  
Avalanche Rated

**IXTA1N80P**  
**IXTP1N80P**  
**IXTU1N80P**  
**IXTY1N80P**

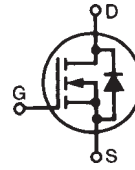

$$V_{DSS} = 800V$$

$$I_{D25} = 1A$$

$$R_{DS(on)} \leq 14\Omega$$

TO-263 (IXTA)

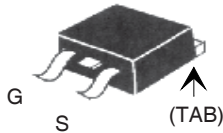

TO-220 (IXTP)

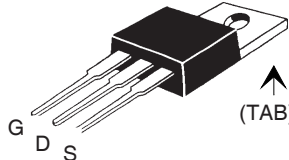

TO-251 (IXTU)

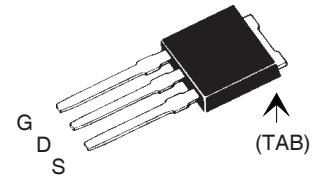

TO-252 (IXTY)

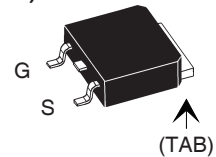

G = Gate      D = Drain  
S = Source    TAB = Drain

Symbol	Test Conditions	Maximum Ratings	
$V_{DSS}$	$T_J = 25^\circ\text{C}$ to $150^\circ\text{C}$	800	V
$V_{DGR}$	$T_J = 25^\circ\text{C}$ to $150^\circ\text{C}$ , $R_{GS} = 1M\Omega$	800	V
$V_{GSS}$	Continuous	$\pm 20$	V
$V_{GSM}$	Transient	$\pm 30$	V
$I_{D25}$	$T_C = 25^\circ\text{C}$	1	A
$I_{DM}$	$T_C = 25^\circ\text{C}$ , Pulse Width Limited by $T_{JM}$	2	A
$I_A$	$T_C = 25^\circ\text{C}$	1	A
$E_{AS}$	$T_C = 25^\circ\text{C}$	75	mJ
$dV/dt$	$I_S \leq I_{DM}$ , $V_{DD} \leq V_{DSS}$ , $T_J \leq 150^\circ\text{C}$	5	V/ns
$P_D$	$T_C = 25^\circ\text{C}$	42	W
$T_J$		-55 ... +150	$^\circ\text{C}$
$T_{JM}$		150	$^\circ\text{C}$
$T_{stg}$		-55 ... +150	$^\circ\text{C}$
$T_L$	1.6mm (0.062) from Case for 10s	300	$^\circ\text{C}$
$T_{SOLD}$	Plastic Body for 10s	260	$^\circ\text{C}$
$M_d$	Mounting Torque (TO-220)	1.13 / 10	Nm/lb.in.
<b>Weight</b>	TO-263	2.50	g
	TO-220	3.00	g
	TO-252	0.35	g
	TO-251	0.40	g

Symbol	Test Conditions ( $T_J = 25^\circ\text{C}$ , Unless Otherwise Specified)	Characteristic Values		
		Min.	Typ.	Max.
$BV_{DSS}$	$V_{GS} = 0V$ , $I_D = 250\mu\text{A}$	800		V
$V_{GS(th)}$	$V_{DS} = V_{GS}$ , $I_D = 50\mu\text{A}$	2.0		4.0 V
$I_{GSS}$	$V_{GS} = \pm 20V$ , $V_{DS} = 0V$			$\pm 100$ nA
$I_{DSS}$	$V_{DS} = V_{DSS}$			3 $\mu\text{A}$
	$V_{GS} = 0V$ $T_J = 125^\circ\text{C}$			30 $\mu\text{A}$
$R_{DS(on)}$	$V_{GS} = 10V$ , $I_D = 0.5 \cdot I_{D25}$ , Note 1		10	14 $\Omega$

## Features

- International Standard Packages
- Fast Intrinsic Rectifier
- Avalanche Rated
- Low Package Inductance

## Advantages

- Easy to Mount
- Space Savings
- High Power Density

## Applications

- Switched-Mode and Resonant-Mode Power Supplies
- DC-DC Converters
- Laser Drivers
- AC and DC Motor Drives
- Robotics and Servo Controls

Symbol	Test Conditions ( $T_J = 25^\circ\text{C}$ , Unless Otherwise Specified)	Characteristic Values		
		Min.	Typ.	Max.
$g_{fs}$	$V_{DS} = 20\text{V}$ , $I_D = 0.5 \cdot I_{D25}$ , Note 1	0.30	0.55	S
$C_{iss}$ $C_{oss}$ $C_{rss}$	$V_{GS} = 0\text{V}$ , $V_{DS} = 25\text{V}$ , $f = 1\text{MHz}$		250	pF
			22	pF
			5.3	pF
$t_{d(on)}$ $t_r$ $t_{d(off)}$ $t_f$	<b>Resistive Switching Times</b> $V_{GS} = 10\text{V}$ , $V_{DS} = 0.5 \cdot V_{DSS}$ , $I_D = 0.5 \cdot I_{D25}$ $R_G = 50\Omega$ (External)		20	ns
			18	ns
			58	ns
			42	ns
$Q_{g(on)}$ $Q_{gs}$ $Q_{gd}$	$V_{GS} = 10\text{V}$ , $V_{DS} = 0.5 \cdot V_{DSS}$ , $I_D = 0.5 \cdot I_{D25}$		9.0	nC
			1.4	nC
			5.5	nC
$R_{thJC}$ $R_{thCS}$	(TO-220)		0.50	3.0 $^\circ\text{C/W}$ $^\circ\text{C/W}$

Symbol	Test Conditions	Characteristic Values ( $T_J = 25^\circ\text{C}$ , Unless Otherwise Specified)		
		Min.	Typ.	Max.
$I_S$	$V_{GS} = 0\text{V}$			1 A
$I_{SM}$	Repetitive, Pulse Width Limited by $T_{JM}$			4 A
$V_{SD}$	$I_F = I_S$ , $V_{GS} = 0\text{V}$ , Note 1			1.3 V
$t_{rr}$	$I_F = 1\text{A}$ , $-di/dt = 100\text{A}/\mu\text{s}$ $V_R = 100\text{V}$ , $V_{GS} = 0\text{V}$		700	ns

Note 1: Pulse Test,  $t \leq 300\mu\text{s}$ ; Duty Cycle,  $d \leq 2\%$ .

### PRELIMINARY TECHNICAL INFORMATION

The product presented herein is under development. The Technical Specifications offered are derived from data gathered during objective characterizations of preliminary engineering lots; but also may yet contain some information supplied during a pre-production design evaluation. IXYS reserves the right to change limits, test conditions, and dimensions without notice.

IXYS Reserves the Right to Change Limits, Test Conditions, and Dimensions.

IXYS MOSFETs and IGBTs are covered by one or more of the following U.S. patents:	4,835,592	4,931,844	5,049,961	5,237,481	6,162,665	6,404,065 B1	6,683,344	6,727,585	7,005,734 B2	7,157,338B2
	4,850,072	5,017,508	5,063,307	5,381,025	6,259,123 B1	6,534,343	6,710,405 B2	6,759,692	7,063,975 B2	
	4,881,106	5,034,796	5,187,117	5,486,715	6,306,728 B1	6,583,505	6,710,463	6,771,478 B2	7,071,537	

**Fig. 1. Output Characteristics @ 25°C**

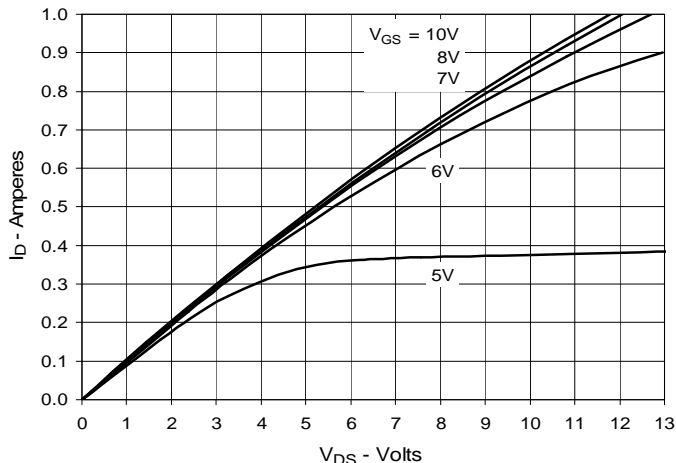

**Fig. 2. Extended Output Characteristics @ 25°C**

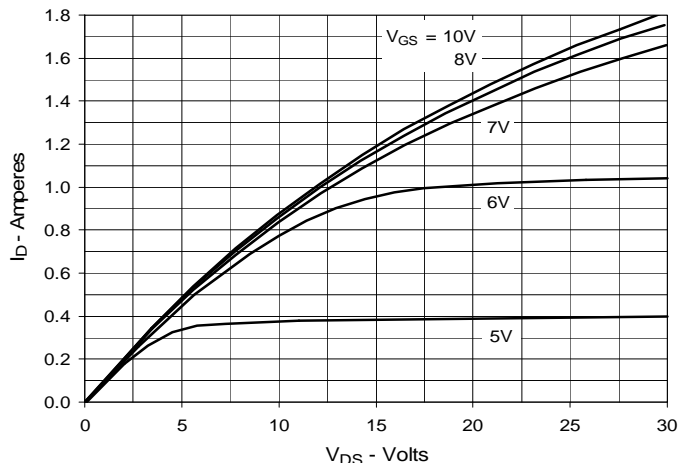

**Fig. 3. Output Characteristics @ 125°C**

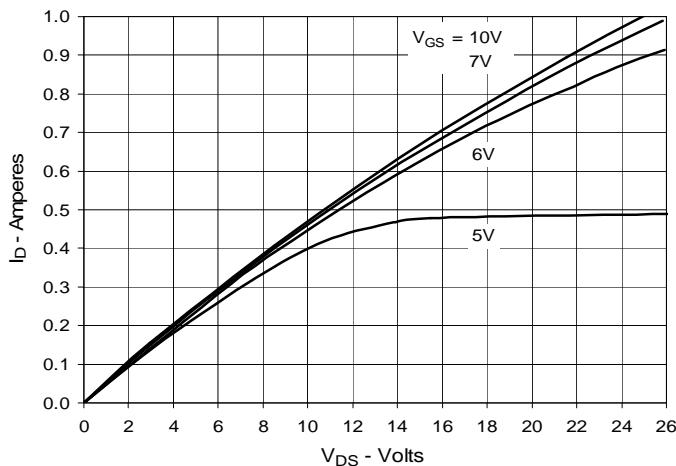

**Fig. 4.  $R_{DS(on)}$  Normalized to  $I_D = 0.5A$  Value vs. Junction Temperature**

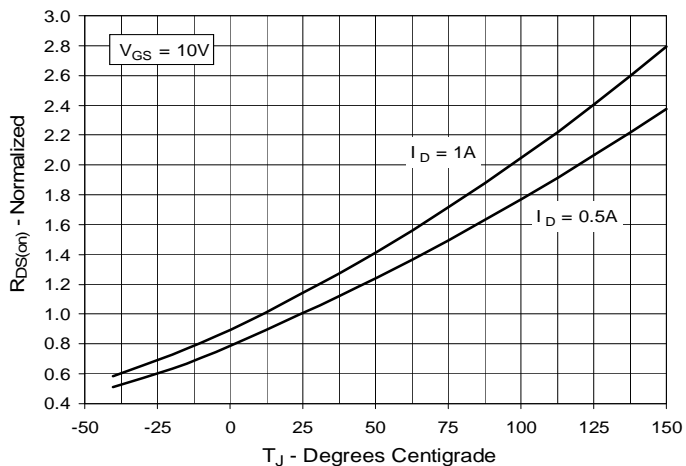

**Fig. 5.  $R_{DS(on)}$  Normalized to  $I_D = 0.5A$  Value vs. Drain Current**

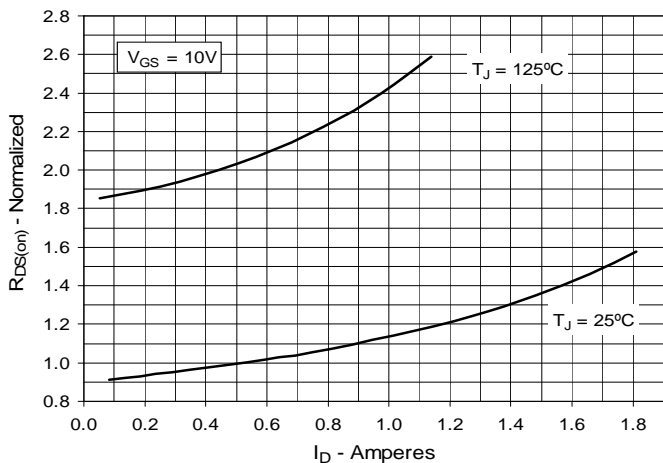

**Fig. 6. Maximum Drain Current vs. Case Temperature**

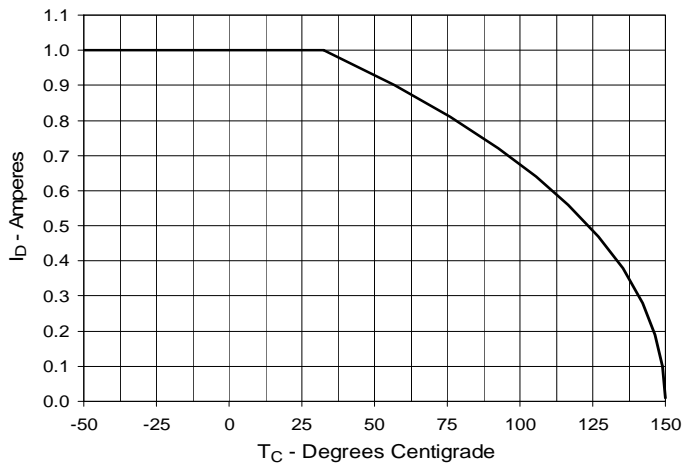

**Fig. 7. Input Admittance**

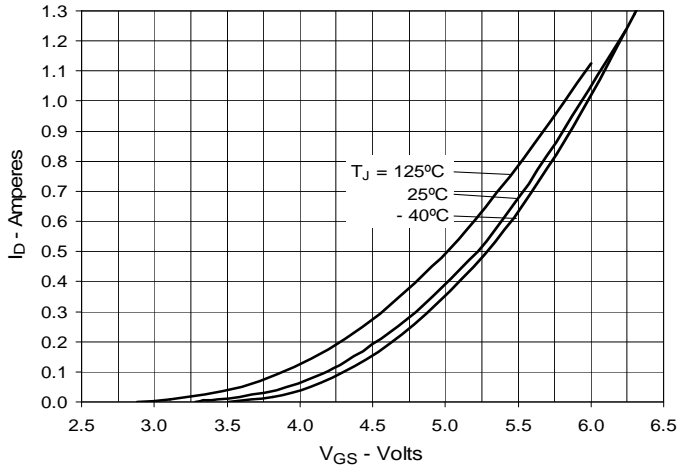

**Fig. 8. Transconductance**

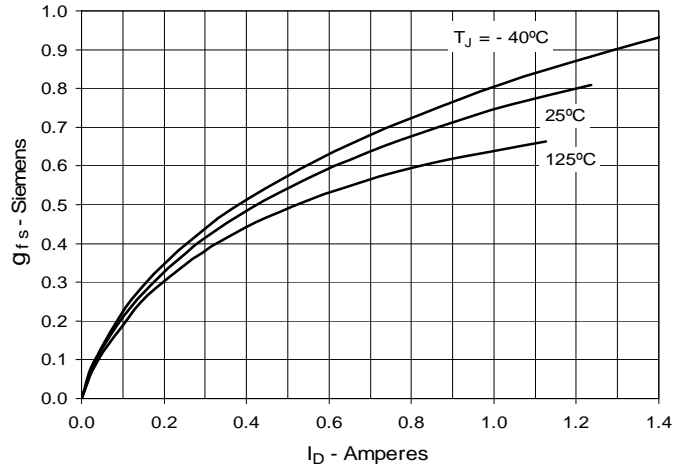

**Fig. 9. Forward Voltage Drop of Intrinsic Diode**

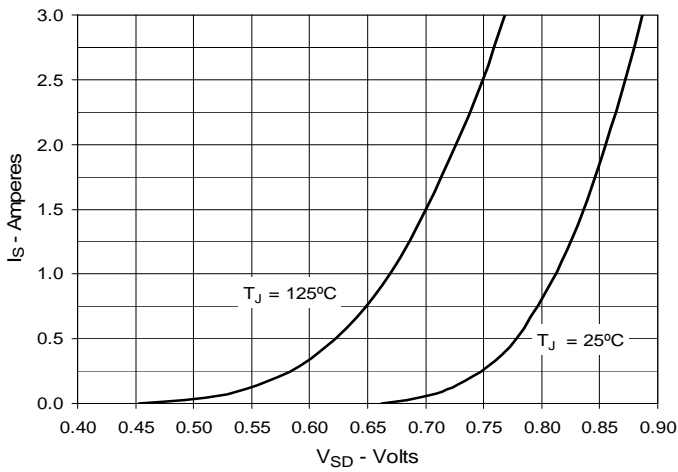

**Fig. 10. Gate Charge**

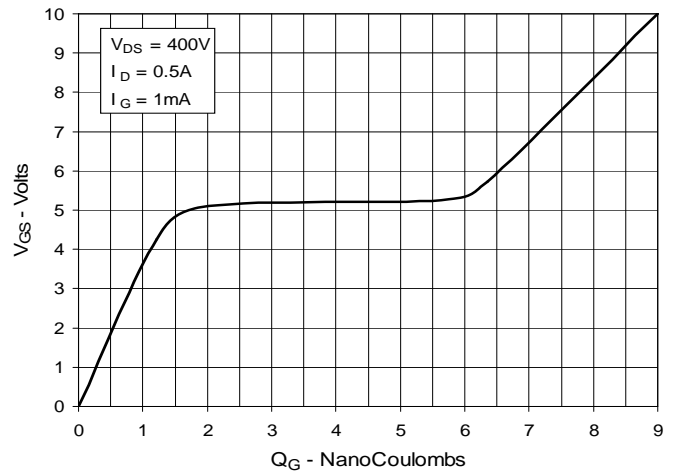

**Fig. 11. Capacitance**

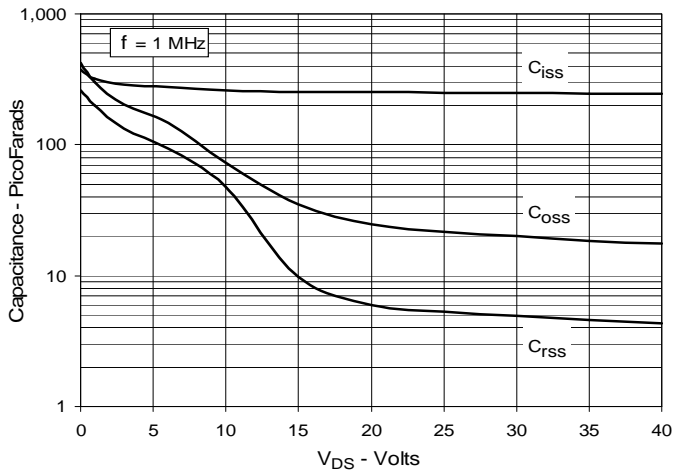

**Fig. 12. Maximum Transient Thermal Impedance**

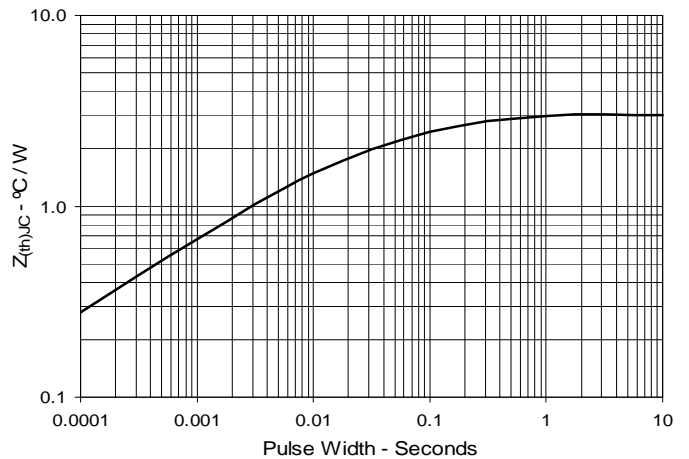

### TO-220 (IXTP) Outline

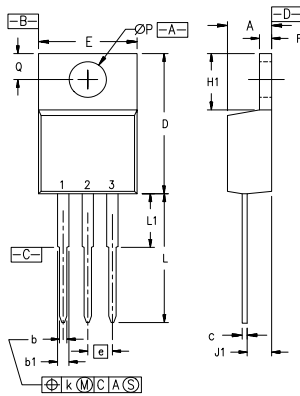

Pins: 1 - Gate 2 - Drain

SYM	INCHES		MILLIMETERS	
	MIN	MAX	MIN	MAX
A	.170	.190	4.32	4.83
b	.025	.040	0.64	1.02
b1	.045	.065	1.15	1.65
c	.014	.022	0.35	0.56
D	.580	.630	14.73	16.00
E	.390	.420	9.91	10.66
e	.100 BSC		2.54 BSC	
F	.045	.055	1.14	1.40
H1	.230	.270	5.85	6.85
J1	.090	.110	2.29	2.79
k	0	.015	0	0.38
L	.500	.550	12.70	13.97
L1	.110	.230	2.79	5.84
ØP	.139	.161	3.53	4.08
Q	.100	.125	2.54	3.18

### TO-251 (IXTU) Outline

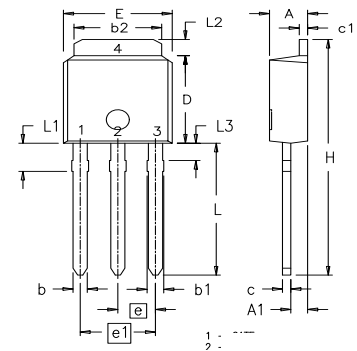

1. Gate 2. Drain  
3. Source 4. Drain

Dim.	Millimeter		Inches	
	Min.	Max.	Min.	Max.
A	2.19	2.38	.086	.094
A1	0.89	1.14	0.35	.045
b	0.64	0.89	.025	.035
b1	0.76	1.14	.030	.045
b2	5.21	5.46	.205	.215
c	0.46	0.58	.018	.023
c1	0.46	0.58	.018	.023
D	5.97	6.22	.235	.245
E	6.35	6.73	.250	.265
e	2.28 BSC		.090 BSC	
e1	4.57 BSC		.180 BSC	
H	17.02	17.78	.670	.700
L	8.89	9.65	.350	.380
L1	1.91	2.28	.075	.090
L2	0.89	1.27	.035	.050

### TO-263 (IXTA) Outline

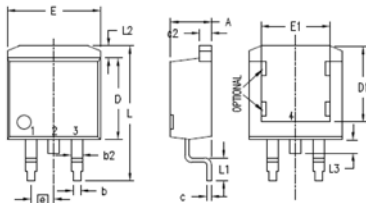

1. GATE (COLLECTOR)  
2. DRAIN (COLLECTOR)  
3. SOURCE (EMITTER)  
4. DRAIN (COLLECTOR)  
BOTTOM SIDE

SYM	INCHES		MILLIMETERS	
	MIN	MAX	MIN	MAX
A	.160	.190	4.06	4.83
A1	.080	.110	2.03	2.79
b	.020	.039	0.51	0.99
b2	.045	.055	1.14	1.40
c	.016	.029	0.40	0.74
c2	.045	.055	1.14	1.40
D	.340	.380	8.64	9.65
D1	.315	.350	8.00	8.89
E	.380	.410	9.65	10.41
E1	.245	.320	6.22	8.13
e	.100 BSC		2.54 BSC	
L	.575	.625	14.61	15.88
L1	.090	.110	2.29	2.79
L2	.040	.055	1.02	1.40
L3	.050	.070	1.27	1.78
L4	0	.005	0	0.13

### TO-252 (IXTY) Outline

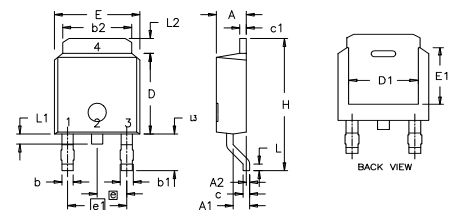

Pins: 1 - Gate 2,4 - Drain  
3 - Source

Dim.	Millimeter		Inches	
	Min.	Max.	Min.	Max.
A	2.19	2.38	0.086	0.094
A1	0.89	1.14	0.035	0.045
A2	0	0.13	0	0.005
b	0.64	0.89	0.025	0.035
b1	0.76	1.14	0.030	0.045
b2	5.21	5.46	0.205	0.215
c	0.46	0.58	0.018	0.023
c1	0.46	0.58	0.018	0.023
D	5.97	6.22	0.235	0.245
D1	4.32	5.21	0.170	0.205
E	6.35	6.73	0.250	0.265
E1	4.32	5.21	0.170	0.205
e	2.28 BSC		0.090 BSC	
e1	4.57 BSC		0.180 BSC	
H	9.40	10.42	0.370	0.410
L	0.51	1.02	0.020	0.040
L1	0.64	1.02	0.025	0.040
L2	0.89	1.27	0.035	0.050
L3	2.54	2.92	0.100	0.115