

**GigaMOS™ TrenchT2**  
**HiperFET™**  
**Power MOSFET**

**IXFK220N17T2**  
**IXFX220N17T2**

$V_{DSS} = 170V$   
 $I_{D25} = 220A$   
 $R_{DS(on)} \leq 6.3m\Omega$   
 $t_{rr} \leq 140ns$

N-Channel Enhancement Mode  
 Avalanche Rated  
 Fast Intrinsic Diode

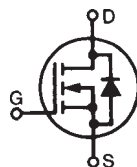

TO-264 (IXFK)

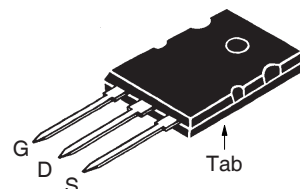

PLUS247 (IXFX)

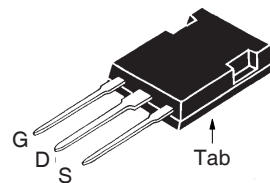

G = Gate      D = Drain  
 S = Source    Tab = Drain

Symbol	Test Conditions	Maximum Ratings	
$V_{DSS}$	$T_J = 25^\circ C$ to $175^\circ C$	170	V
$V_{DGR}$	$T_J = 25^\circ C$ to $175^\circ C$ , $R_{GS} = 1M\Omega$	170	V
$V_{GSS}$	Continuous	$\pm 20$	V
$V_{GSM}$	Transient	$\pm 30$	V
$I_{D25}$	$T_C = 25^\circ C$ (Chip Capability)	220	A
$I_{L(RMS)}$	External Lead Current Limit	160	A
$I_{DM}$	$T_C = 25^\circ C$ , Pulse Width Limited by $T_{JM}$	550	A
$I_A$	$T_C = 25^\circ C$	110	A
$E_{AS}$	$T_C = 25^\circ C$	2	J
$P_D$	$T_C = 25^\circ C$	1250	W
dv/dt	$I_S \leq I_{DM}$ , $V_{DD} \leq V_{DSS}$ , $T_J \leq 175^\circ C$	20	V/ns
$T_J$		-55 ... +175	$^\circ C$
$T_{JM}$		175	$^\circ C$
$T_{stg}$		-55 ... +175	$^\circ C$
$T_L$	1.6mm (0.062 in.) from Case for 10s	300	$^\circ C$
$T_{SOLD}$	Plastic Body for 10s	260	$^\circ C$
$M_d$	Mounting Torque (TO-264)	1.13/10	Nm/lb.in.
$F_C$	Mounting Force (PLUS247)	20..120 / 4.5..27	N/lb.
Weight	TO-264	10	g
	PLUS247	6	g

Symbol	Test Conditions ( $T_J = 25^\circ C$ Unless Otherwise Specified)	Characteristic Values		
		Min.	Typ.	Max.
$BV_{DSS}$	$V_{GS} = 0V$ , $I_D = 3mA$	170		V
$V_{GS(th)}$	$V_{DS} = V_{GS}$ , $I_D = 8mA$	2.5		5.0 V
$I_{GSS}$	$V_{GS} = \pm 20V$ , $V_{DS} = 0V$			$\pm 200$ nA
$I_{DSS}$	$V_{DS} = V_{DSS}$ , $V_{GS} = 0V$ $T_J = 150^\circ C$			25 $\mu A$ 3 mA
$R_{DS(on)}$	$V_{GS} = 10V$ , $I_D = 60A$ , Note 1	5.1		6.3 $m\Omega$

### Features

- High Current Handling Capability
- Fast Intrinsic Diode
- Avalanche Rated
- Low  $R_{DS(on)}$

### Advantages

- Easy to Mount
- Space Savings
- High Power Density

### Applications

- Synchronous Rectification
- DC-DC Converters
- Battery Chargers
- Switch-Mode and Resonant-Mode Power Supplies
- DC Choppers
- AC Motor Drives
- Uninterruptible Power Supplies
- High Speed Power Switching Applications

Symbol	Test Conditions	Characteristic Values		
		Min.	Typ.	Max.
$g_{fs}$	$V_{DS} = 10V, I_D = 60A$ , Note 1	105	175	S
$C_{iss}$	$V_{GS} = 0V, V_{DS} = 25V, f = 1MHz$		31	nF
$C_{oss}$			2130	pF
$C_{rss}$			290	pF
$R_{Gi}$	Gate Input Resistance		1.40	$\Omega$
$t_{d(on)}$	<b>Resistive Switching Times</b> $V_{GS} = 10V, V_{DS} = 0.5 \cdot V_{DSS}, I_D = 0.5 \cdot I_{D25}$ $R_G = 1\Omega$ (External)		44	ns
$t_r$			160	ns
$t_{d(off)}$			40	ns
$t_f$			150	ns
$Q_{g(on)}$	$V_{GS} = 10V, V_{DS} = 0.5 \cdot V_{DSS}, I_D = 0.5 \cdot I_{D25}$		500	nC
$Q_{gs}$			130	nC
$Q_{gd}$			137	nC
$R_{thJC}$			0.12	$^{\circ}C/W$
$R_{thCS}$		0.15		$^{\circ}C/W$

### Source-Drain Diode

Symbol	Test Conditions	Characteristic Values		
		Min.	Typ.	Max.
$I_s$	$V_{GS} = 0V$			220 A
$I_{SM}$	Repetitive, Pulse Width Limited by $T_{JM}$			880 A
$V_{SD}$	$I_F = 100A, V_{GS} = 0V$ , Note 1			1.3 V
$t_{rr}$	$I_F = 110A, -di/dt = 100A/\mu s$ $V_R = 85V, V_{GS} = 0V$			140 ns
$Q_{RM}$			0.5	$\mu C$
$I_{RM}$			8.6	A

Note 1. Pulse test,  $t \leq 300\mu s$ , duty cycle,  $d \leq 2\%$ .

### ADVANCE TECHNICAL INFORMATION

The product presented herein is under development. The Technical Specifications offered are derived from a subjective evaluation of the design, based upon prior knowledge and experience, and constitute a "considered reflection" of the anticipated result. IXYS reserves the right to change limits, test conditions, and dimensions without notice.

IXYS Reserves the Right to Change Limits, Test Conditions, and Dimensions.

IXYS MOSFETs and IGBTs are covered by one or more of the following U.S. patents:	4,835,592	4,931,844	5,049,961	5,237,481	6,162,665	6,404,065 B1	6,683,344	6,727,585	7,005,734 B2	7,157,338B2
	4,850,072	5,017,508	5,063,307	5,381,025	6,259,123 B1	6,534,343	6,710,405 B2	6,759,692	7,063,975 B2	
	4,881,106	5,034,796	5,187,117	5,486,715	6,306,728 B1	6,583,505	6,710,463	6,771,478 B2	7,071,537	

### TO-264 (IXFK) Outline

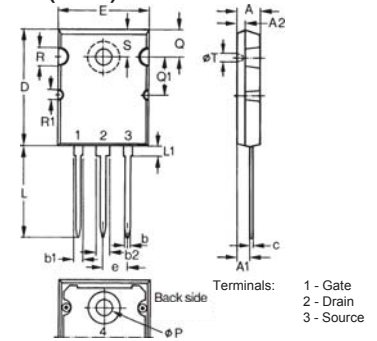

Dim.	Millimeter		Inches	
	Min.	Max.	Min.	Max.
A	4.82	5.13	.190	.202
A1	2.54	2.89	.100	.114
A2	2.00	2.10	.079	.083
b	1.12	1.42	.044	.056
b1	2.39	2.69	.094	.106
b2	2.90	3.09	.114	.122
c	0.53	0.83	.021	.033
D	25.91	26.16	1.020	1.030
E	19.81	19.96	.780	.786
e	5.46 BSC		.215 BSC	
J	0.00	0.25	.000	.010
K	0.00	0.25	.000	.010
L	20.32	20.83	.800	.820
L1	2.29	2.59	.090	.102
P	3.17	3.66	.125	.144
Q	6.07	6.27	.239	.247
Q1	8.38	8.69	.330	.342
R	3.81	4.32	.150	.170
R1	1.78	2.29	.070	.090
S	6.04	6.30	.238	.248
T	1.57	1.83	.062	.072

### PLUS 247™ (IXFX) Outline

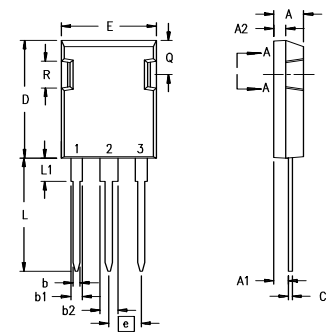

Dim.	Millimeter		Inches	
	Min.	Max.	Min.	Max.
A	4.83	5.21	.190	.205
A1	2.29	2.54	.090	.100
A2	1.91	2.16	.075	.085
b	1.14	1.40	.045	.055
b1	1.91	2.13	.075	.084
b2	2.92	3.12	.115	.123
C	0.61	0.80	.024	.031
D	20.80	21.34	.819	.840
E	15.75	16.13	.620	.635
e	5.45 BSC		.215 BSC	
L	19.81	20.32	.780	.800
L1	3.81	4.32	.150	.170
Q	5.59	6.20	.220	0.244
R	4.32	4.83	.170	.190

Fig. 1. Output Characteristics @  $T_J = 25^\circ\text{C}$

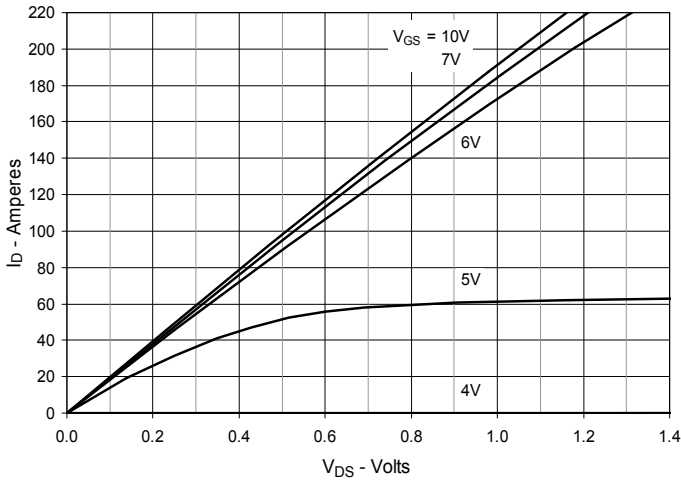

Fig. 2. Extended Output Characteristics @  $T_J = 25^\circ\text{C}$

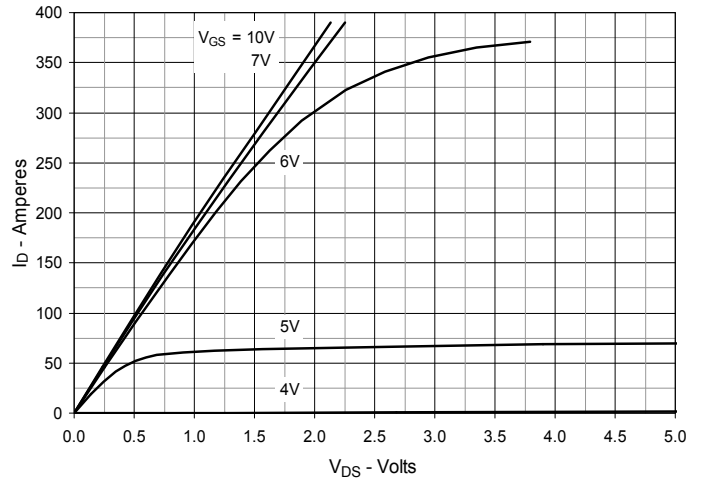

Fig. 3. Output Characteristics @  $T_J = 150^\circ\text{C}$

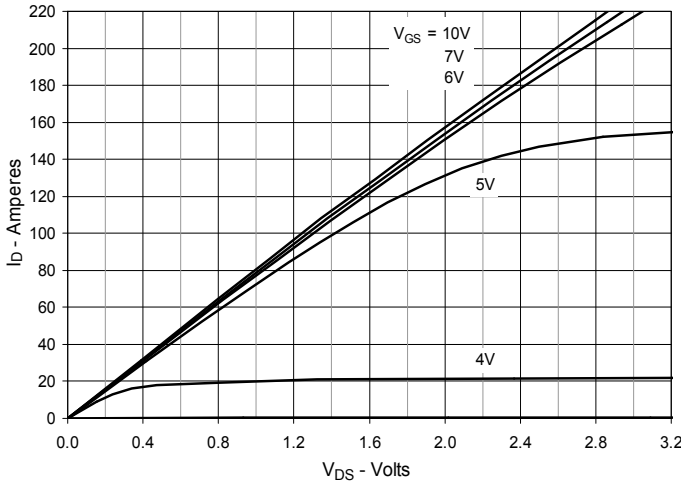

Fig. 4.  $R_{DS(on)}$  Normalized to  $I_D = 110\text{A}$  Value vs. Junction Temperature

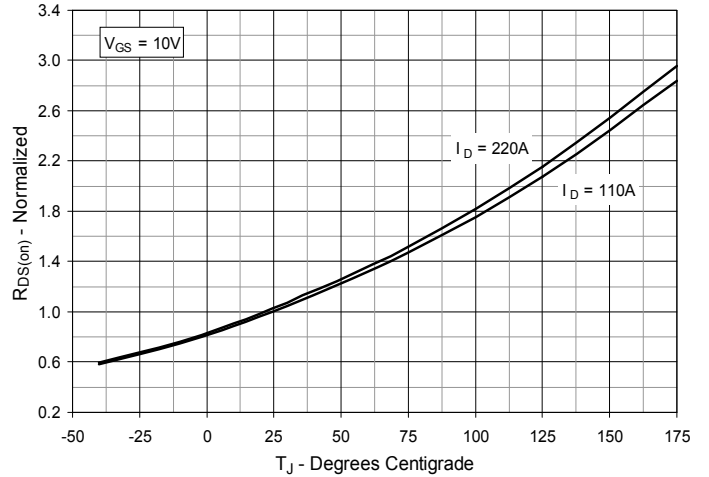

Fig. 5. Normalized  $R_{DS(on)}$   $I_D = 110\text{A}$  Value vs. Drain Current

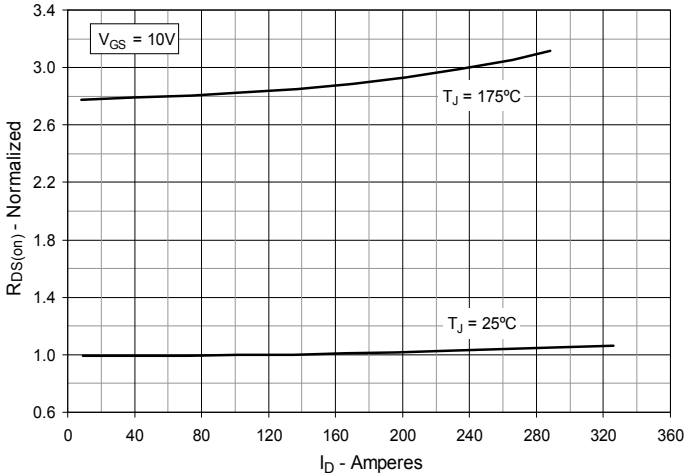
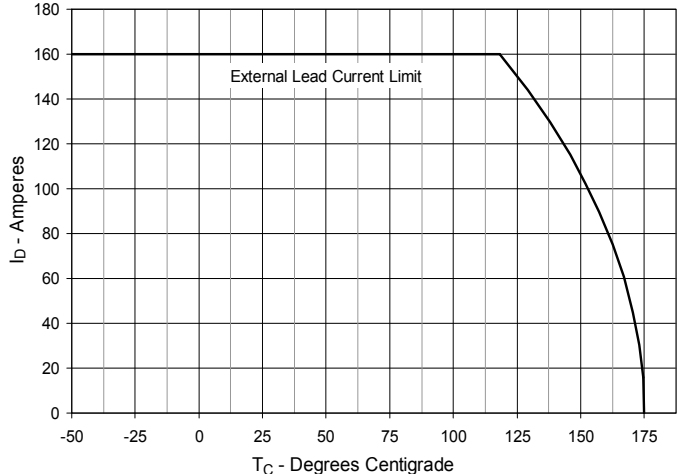
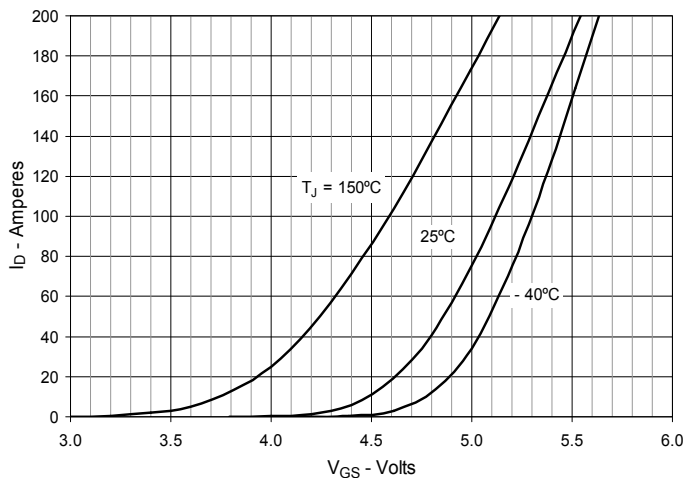

Fig. 6. Drain Current vs. Case Temperature



**Fig. 7. Input Admittance**



**Fig. 8. Transconductance**

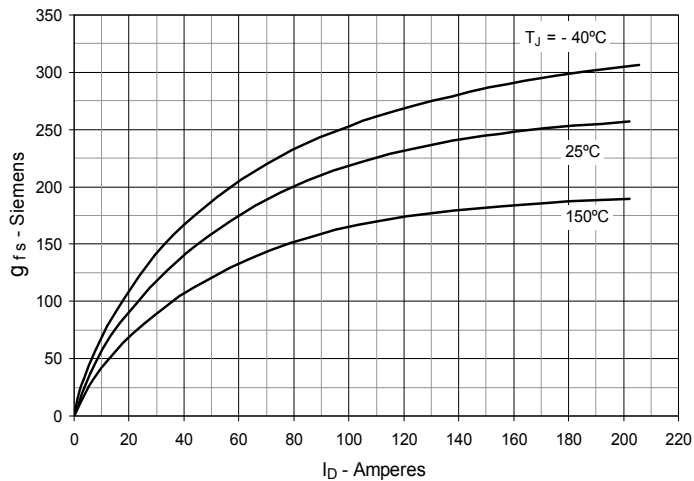

**Fig. 9. Forward Voltage Drop of Intrinsic Diode**

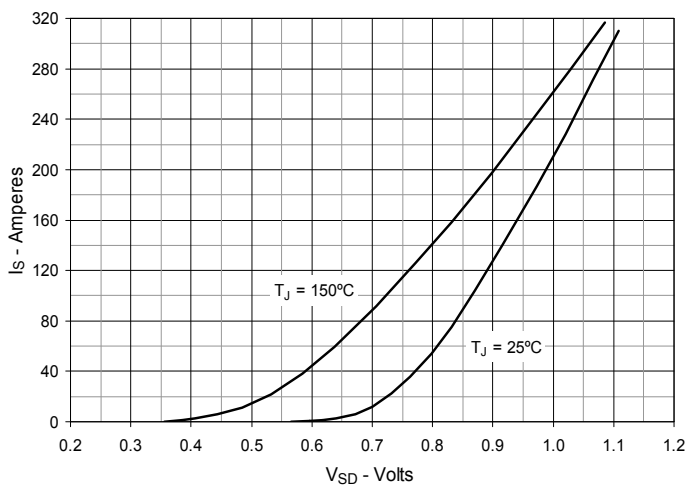

**Fig. 10. Gate Charge**

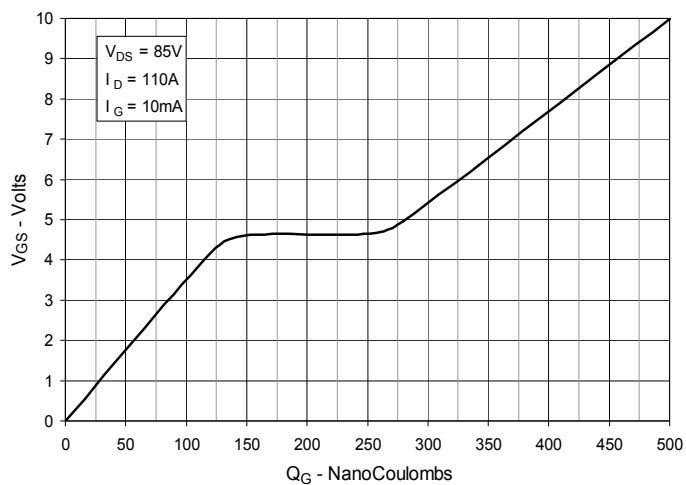

**Fig. 11. Capacitance**

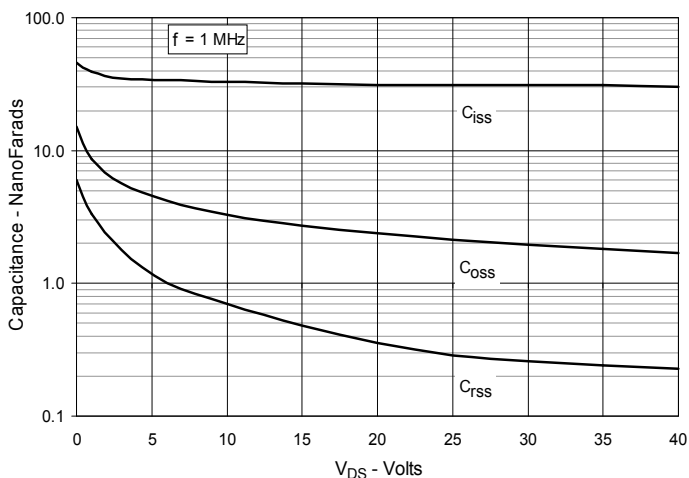

**Fig. 12. Forward-Bias Safe Operating Area**

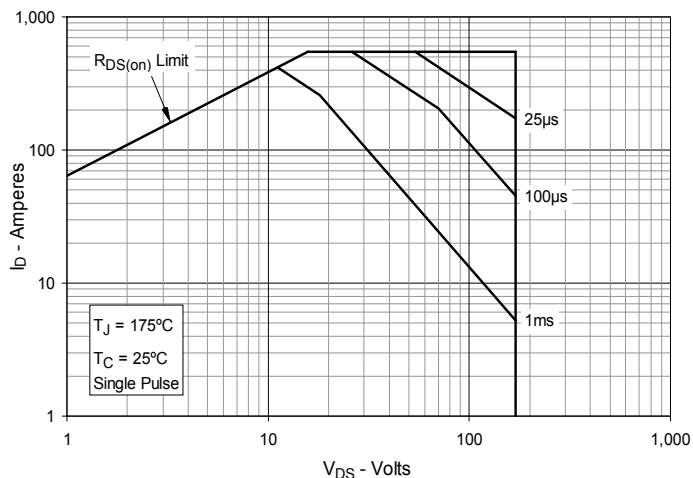

**Fig. 13. Resistive Turn-on Rise Time vs. Junction Temperature**

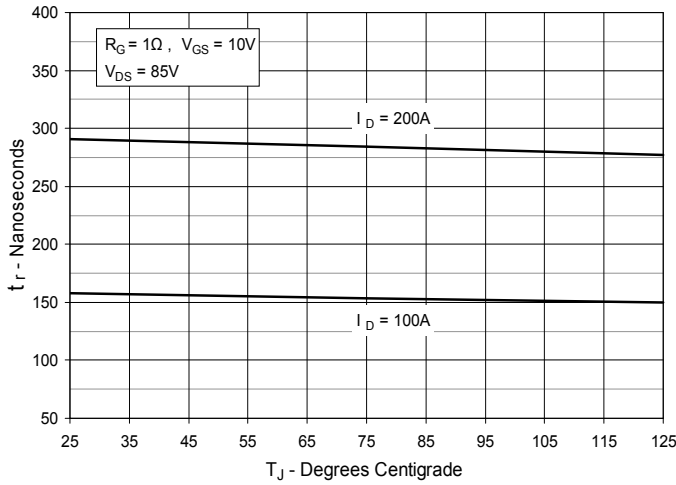

**Fig. 14. Resistive Turn-on Rise Time vs. Drain Current**

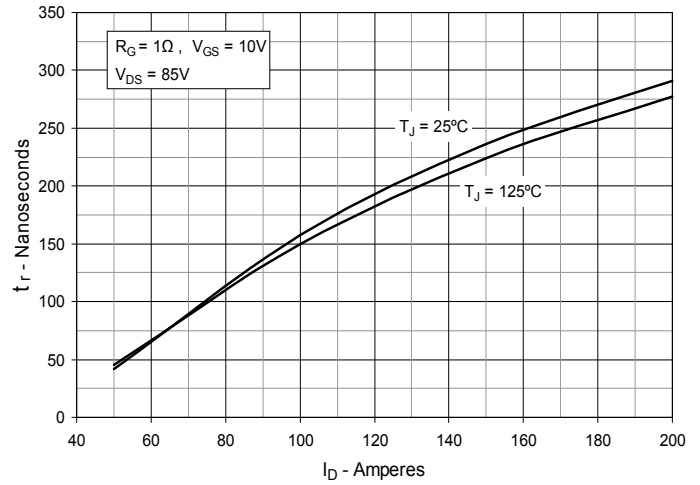

**Fig. 15. Resistive Turn-on Switching Times vs. Gate Resistance**

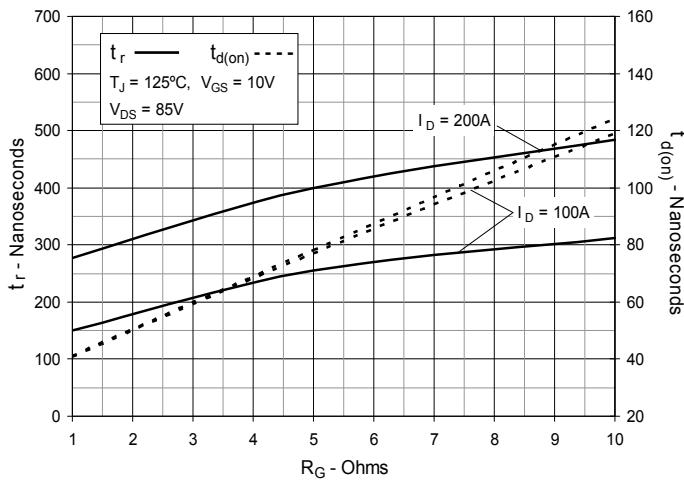

**Fig. 16. Resistive Turn-off Switching Times vs. Junction Temperature**

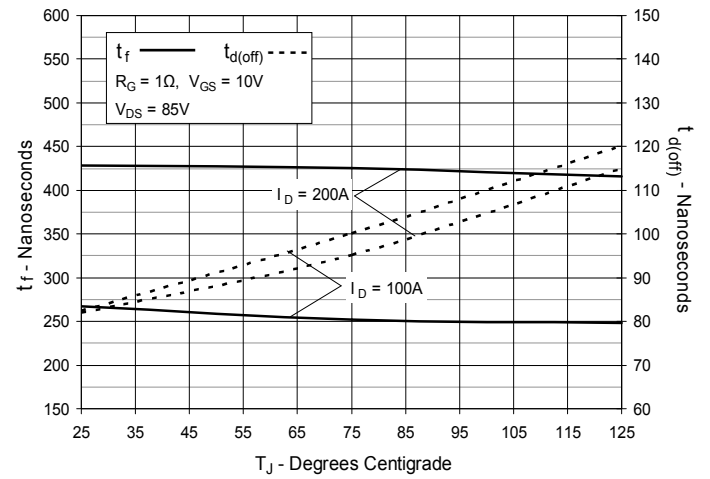

**Fig. 17. Resistive Turn-off Switching Times vs. Drain Current**

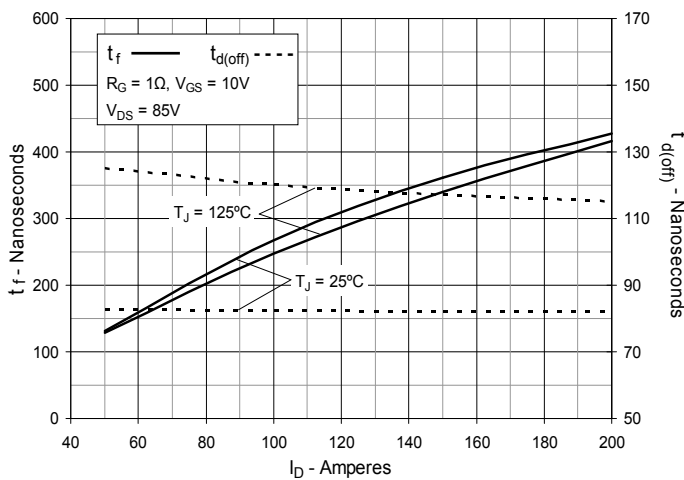

**Fig. 18. Resistive Turn-off Switching Times vs. Gate Resistance**

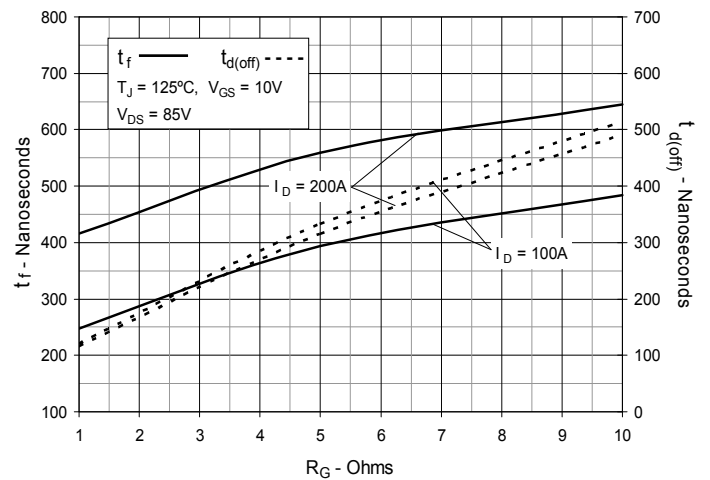
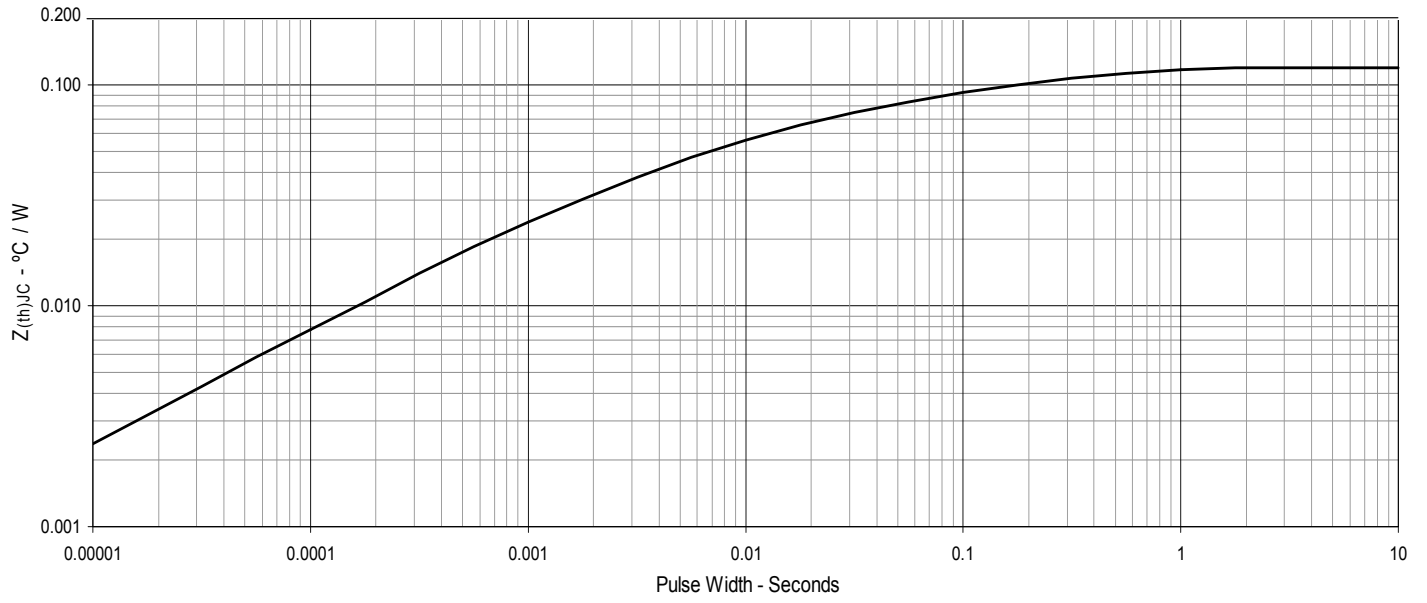

Fig. 19. Maximum Transient Thermal Impedance





---

Disclaimer Notice - Information furnished is believed to be accurate and reliable. However, users should independently evaluate the suitability of and test each product selected for their own applications. Littelfuse products are not designed for, and may not be used in, all applications. Read complete Disclaimer Notice at [www.littelfuse.com/disclaimer-electronics](http://www.littelfuse.com/disclaimer-electronics).