

HTN-PL32 Datasheet

Technical Specifications

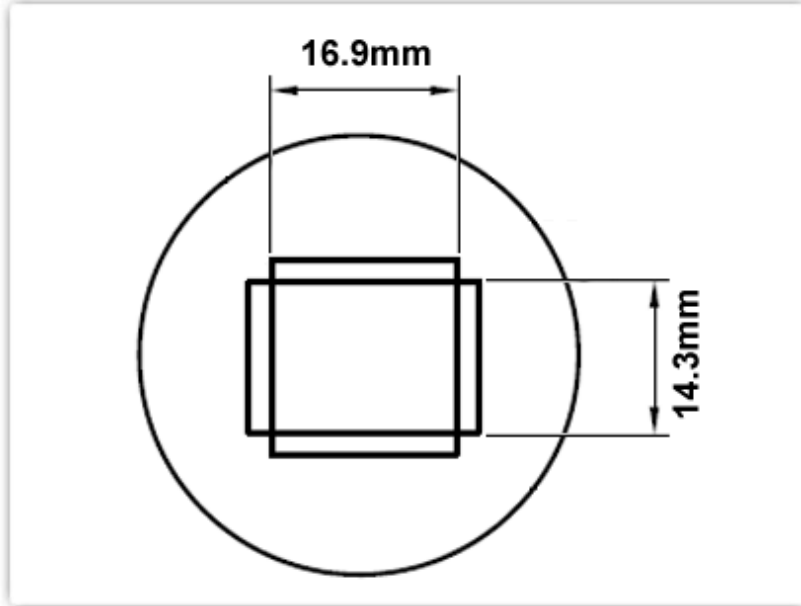

HTN-PL32

Nozzle 16.9mm x 14.3mm, PLCC-32

Nozzle Style: PLCC-32

Nozzle Width: 16.90mm (0.67")

Nozzle Height: 14.30mm (0.56")

Nozzle Type:	HTN Series
RoHS Compliant / Lead Free:	YES
Equivalent to:	H-P32
For Use With:	TMT-HA200, TMT-HA300, HCT-900

Material Composition

Stainless Steel



All components are RoHS compliant and Lead-Free.



**Standard Connector
22mm (0.87") diameter**