

HTN-B3636 Datasheet

Technical Specifications

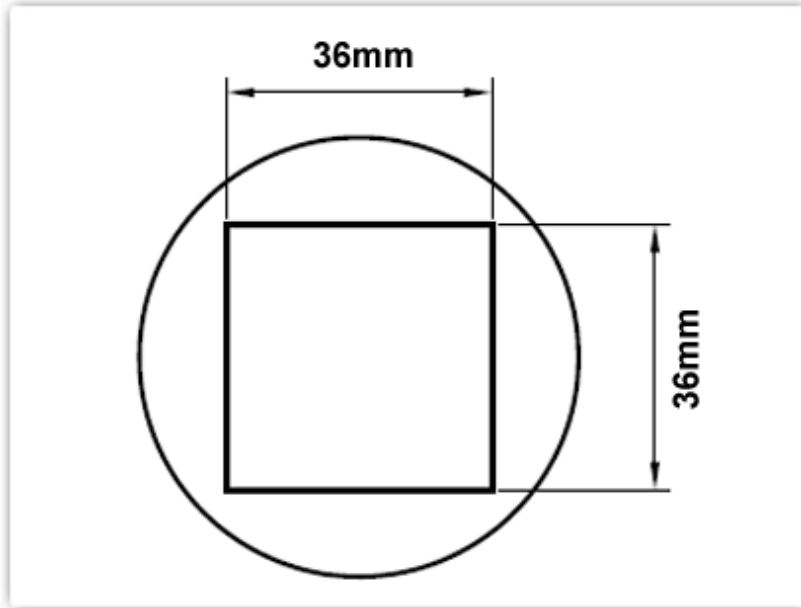

HTN-B3636

Nozzle 36.0mm x 36.0mm, BGA

Nozzle Style: BGA

Nozzle Width: 36.00mm (1.42")

Nozzle Height: 36.00mm (1.42")

Nozzle Type:	HTN Series
RoHS Compliant / Lead Free:	YES
For Use With:	TMT-HA200, TMT-HA300, HCT-900

Material Composition

Stainless Steel



**All components
are RoHS
compliant and
Lead-Free.**

**Standard Connector
22mm (0.87") diameter**