

VISIBLE LIGHT PRODUCTS SPECIFICATION

HPR40E-4xK100x



High Power 100W LED

Drawn by	Checked by	Approved by



DATE:2011/8/4

REV:D



HUEY JANN ELECTRONICS INDUSTRY CO., LTD.

No.27 Line 466 Sec.2,Cannng-nan Rd. Wu-chi Town Taichung Shien, Taiwan, R.O.C.

TEL:+886-4-26393976 FAX:+886-4-26393125

HUEY JANN High Power 100W LED is made of hi-eff AS/TS GaInN chips with precise package technique which makes excellent heat dissipation to reach the advantages of high luminous efficiency, low decay, and long endurance. Now we have these colors available: red, green, blue, white, yellow .

FEATERUS

- Instant light
- Long operating life
- Superior ESD defense
- Low voltage DC operated
- More energy efficient than incandescent and most halogen lamps
- Color bright saturated

TYPICAL APPLICATIONS

- Architectural detail lighting
- Medical applications
- Beacon lights
- Decoration lights



HUEY JANN ELECTRONICS INDUSTRY CO., LTD.

No.27 Line 466 Sec.2,Cannng-nan Rd. Wu-chi Town Taichung Shien, Taiwan, R.O.C.

TEL:+886-4-26393976 FAX:+886-4-26393125

Explanation of Part Number:

H P R 40 E - 4 xK 100 x
 ① ② ③ ④ ⑤ ⑥ ⑦ ⑧ ⑨

1.H: Huey Jann

2.P: High power LED Type

3.Shape distinguish:

4.Identification no:

R: Rectangular type

5.Lead frame type

6.Appearance:

1:Yellow Diffusion 4:White Diffusion

7.Color number:

8.Power type:

3K: Green 4K: Yellow

50: 50W 100: 100W

5K: Red 8K: Blue

9K: White

9.Color kind:

G: Green Y: Yellow R: Red BG: Blue

DEVICES

Item	Lens Color	Dice Source	Color
HPR40E-43K100G	White Diffusion	GaN/GaN	Gren
HPR40E-44K100Y		AllnGaP/GaP	Yellow
HPR40E-45K100R		AllnGaP/GaP	Red
HPR40E-48K100BG		GaN/GaN	Blue



HUEY JANN ELECTRONICS INDUSTRY CO., LTD.

No.27 Line 466 Sec.2,Cann-g-nan Rd. Wu-chi Town Taichung Shien, Taiwan, R.O.C.

TEL:+886-4-26393976 FAX:+886-4-26393125

PACKAGE DIMENSIONS:

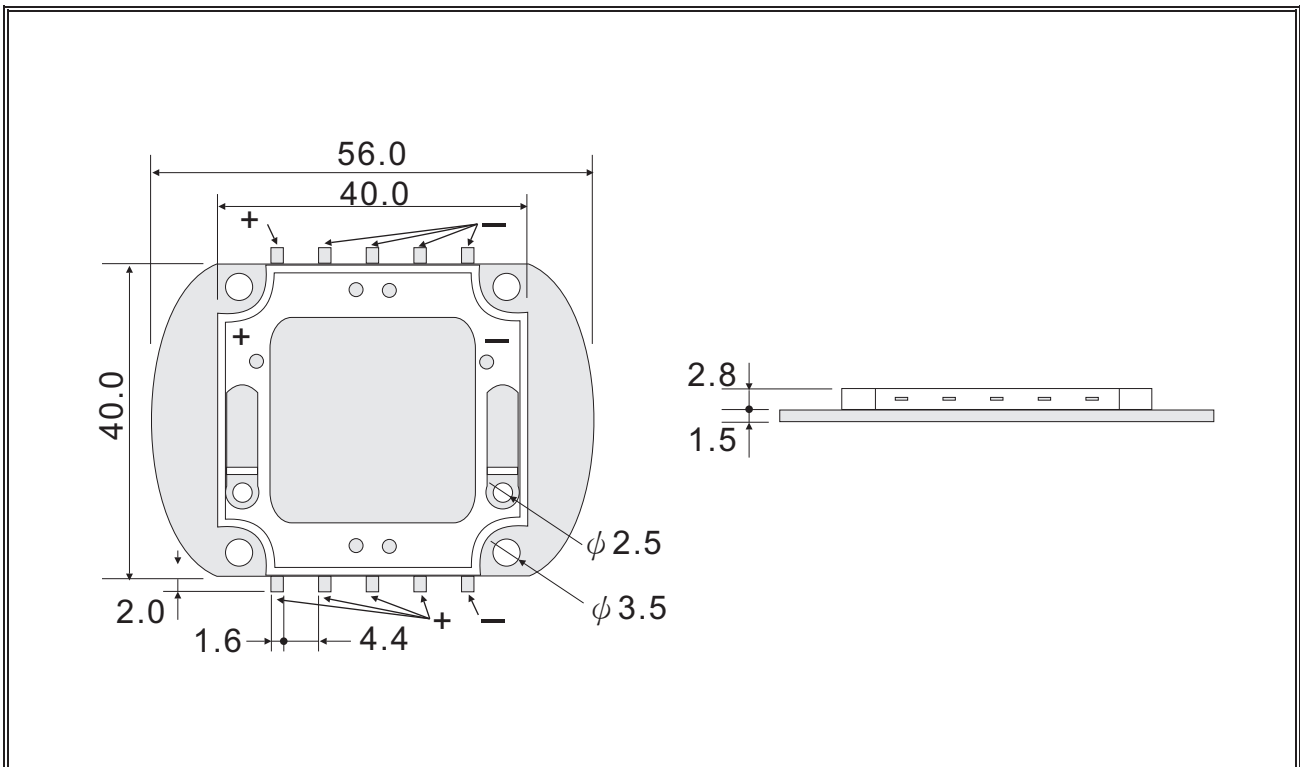

NOTE:

- 1.All dimensions are in millimeter.
- 2.Lead spacing in measured where the lead emerge from the package.
- 3.prodruded resin under flange is 1.5mm max.
- 4.specifications are subject to change without notice.
- 5.Tolerance is 0.3mm unless otherwise noted.
- 6.Driving LED without heat sinking device is forbidden.
- 7.It is strongly recommended that the temperature of lead be not higher than 55°C.
- 8.Proper current derating must be observed to maintain junction temperature below the maximum.
- 9.LEDs are not designed to be driven in reserve bias.
10. Warps the degree 0.5mm.



HUEY JANN ELECTRONICS INDUSTRY CO., LTD.

No.27 Line 466 Sec.2,Cannng-nan Rd. Wu-chi Town Taichung Shien, Taiwan, R.O.C.

TEL:+886-4-26393976 FAX:+886-4-26393125

ABSOLUTE MAXIMUM RATINGS

TA=25°C

PARAMETER	SYMBOL	MAX. RATING		UNIT
Continuous Forward Current	IF	2.8		A
Peak Forward Current *1	IFM	3		A
Electrostatic Discharge (HBM)	ESD	4000		V
LED Junction Temperature	Tj	G · B	135	°C
		R · Y	125	
Operating Temperature	Topr	-40 ~ +110		°C
Storage Temperature	Tstg	-40 ~ +120		°C
Manual Soldering Temperature 260 °C for 5 seconds max. *2				

*1.Duty Ratio=0.1%,Pulse Width=10us.

*2.Iron soldering high temperature will not cause damage to the dice. But be aware of the high temperature will make the epoxy soften and the gold wire broken and even open. So before returning to the normal temperatures PLEASE AVOID any serious pressure on the top of epoxy and lead.

*3. We suggest using PWM (Pulse Width Modulation) for driving.

*4. It is recommended to use series as there are several 3pcs. If there are more than 5pcs, please use product with higher power.



HUEY JANN ELECTRONICS INDUSTRY CO., LTD.

No.27 Line 466 Sec.2,Cannng-nan Rd. Wu-chi Town Taichung Shien, Taiwan, R.O.C.

TEL:+886-4-26393976 FAX:+886-4-26393125

ELECTRIC-OPTICAL CHARACTERISTICS

TA=25°C

Parameter	Symbol	Test Condition	Typ	Unit
View Angle of Half Power	2θ _{1/2}	IF=2800mA	120	deg
Thermal Resistance Junction To Case	R _{θ J-C}		0.5	°C/W
Temperature Coefficient Of Forward Voltage	ΔV _F /ΔT		-2	mV/°C

ELECTRIC-OPTICAL CHARACTERISTICS FOR FORWARD VOLTAGE

TA=25°C

Item	Symbol	Test Condition	Typ	Max	Unit
HPR40E-43K100G	VF	IF=2800mA	35	38	V
HPR40E-44K100Y			23	28	
HPR40E-45K100R			23	28	
HPR40E-48K100BG			33	36	



HUEY JANN ELECTRONICS INDUSTRY CO., LTD.

No.27 Line 466 Sec.2,Cannng-nan Rd. Wu-chi Town Taichung Shien, Taiwan, R.O.C.

TEL:+886-4-26393976 FAX:+886-4-26393125

ELECTRIC-OPTICAL CHARACTERISTICS FOR LUMINOUS INTENSITY

TA=25°C

Item	Symbol	Test Condition	Typ	Unit
HPR40E-43K100G	IV	IF=2800mA	6200	lm
HPR40E-44K100Y			4300	
HPR40E-45K100R			4500	
HPR40E-48K100BG			2880	

ELECTRIC-OPTICAL CHARACTERISTICS FOR WAVELENGTH

TA=25°C

Item	Test Condition	λP	λd	Unit
HPR40E-43K100G	IF=2800mA	520	525	nm
HPR40E-44K100Y		595	590	
HPR40E-45K100R		635	625	
HPR40E-48K100BG		462	465	



HUEY JANN ELECTRONICS INDUSTRY CO., LTD.

No.27 Line 466 Sec.2,Canng-nan Rd. Wu-chi Town Taichung Shien, Taiwan, R.O.C.

TEL:+886-4-26393976 FAX:+886-4-26393125

RELIABILITY TEST

➤ Endurance Test

Test Item	Reference Standard	Test Conditions	Result
Operation Life	MIL-STD-750:1026 MIL-STD-883:1005 JIS-C-7021 :B-1	Connect with a power if=2800mA Ta=Under room temperature Test Time=1,000hrs	0/22
High Temperature High Humidity Storage	MIL-STD-202:103B JIS-C-7021 :B-11	Ta=+85°C 5°C RH=80% ~ 85% Test Time=1,000hrs	0/22
High Temperature Storage	MIL-STD-883:1008 JIS-C-7021 :B-10	High Ta=+120°C 5°C Test Time=1,000hrs	0/22
Low Temperature Storage	JIS-C-7021 :B-12	Low Ta=-40°C 5°C Test Time=1,000hrs	0/22

*Failure Criteria:

1. VF arise $\geq 10\%$
2. IV decline $\geq 30\%$
3. A failure is an LED that is open or shorted



HUEY JANN ELECTRONICS INDUSTRY CO., LTD.

No.27 Line 466 Sec.2,Cannng-nan Rd. Wu-chi Town Taichung Shien, Taiwan, R.O.C.

TEL:+886-4-26393976 FAX:+886-4-26393125

RELIABILITY TEST

➤ Environmental Test

Test Item	Reference Standard	Test Conditions	Result
Temperature Cycling	MIL-STD-202:107D MIL-STD-750:1051 MIL-STD-883:1010 JIS-C-7021 :A-4	-40°C ~ +25°C ~ +85°C ~ +25°C 60min 20min 60min 20min Test Time=200cycle	0/22
Thermal Shock	MIL-STD-202:107D MIL-STD-750:1051 MIL-STD-883:1010	-40°C 5°C ~ +110°C 5°C 20min 20min Test Time=200cycle	0/22

*Failure Criteria:

1. VF arise \geq 10%
2. IV decline \geq 30%
3. A failure is an LED that is open or shorted



HUEY JANN ELECTRONICS INDUSTRY CO., LTD.

No.27 Line 466 Sec.2,Canng-nan Rd. Wu-chi Town Taichung Shien, Taiwan, R.O.C.

TEL:+886-4-26393976 FAX:+886-4-26393125

TYPICAL ELECTRICAL OPTICAL CHARACTERISTICS CURVES

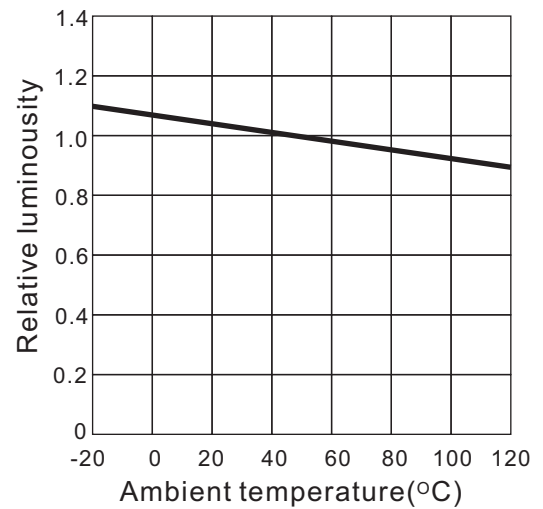
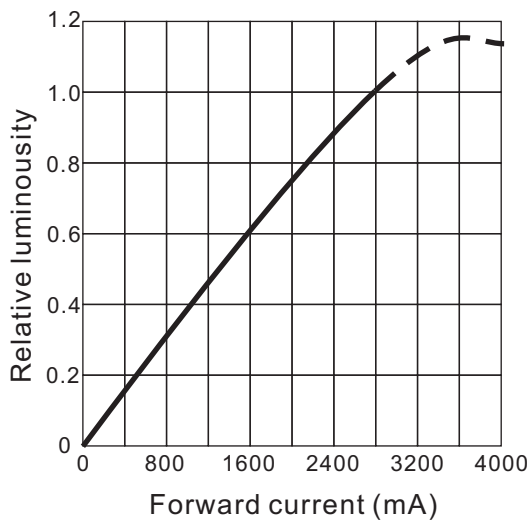
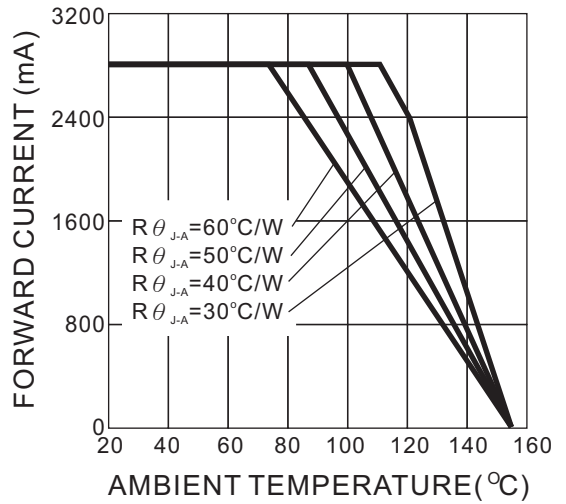
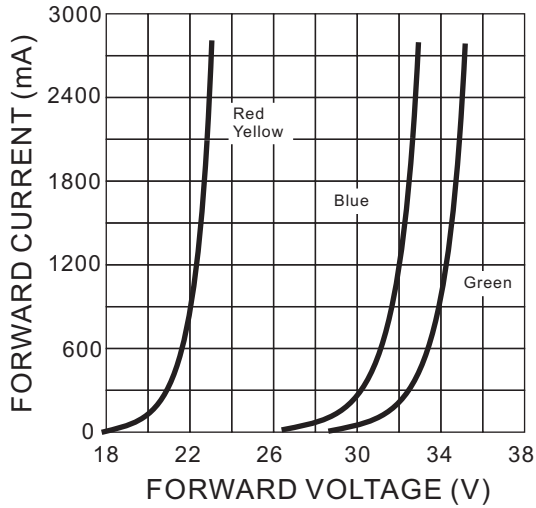

HUEY JANN ELECTRONICS INDUSTRY CO., LTD.

No.27 Line 466 Sec.2,Cannng-nan Rd. Wu-chi Town Taichung Shien, Taiwan, R.O.C.

TEL:+886-4-26393976 FAX:+886-4-26393125

TYPICAL ELECTRICAL OPTICAL CHARACTERISTICS CURVES

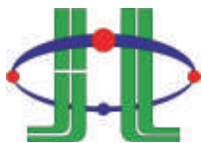
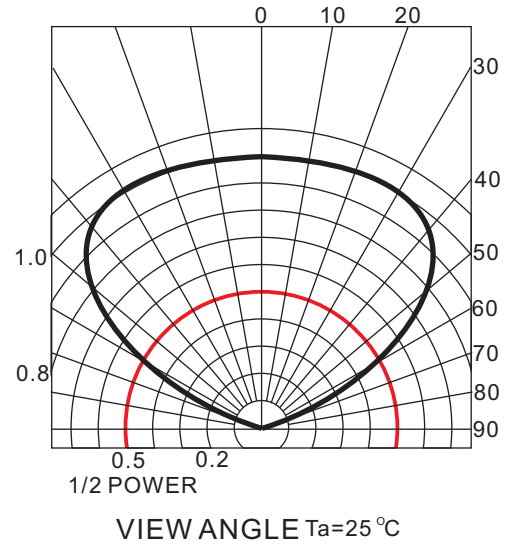
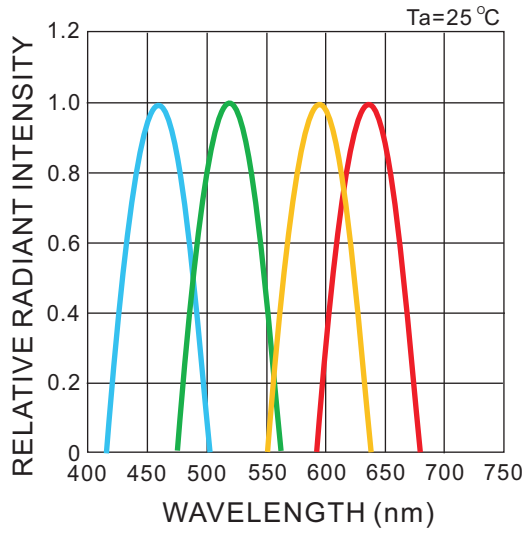

HUEY JANN ELECTRONICS INDUSTRY CO., LTD.

No.27 Line 466 Sec.2,Canng-nan Rd. Wu-chi Town Taichung Shien, Taiwan, R.O.C.

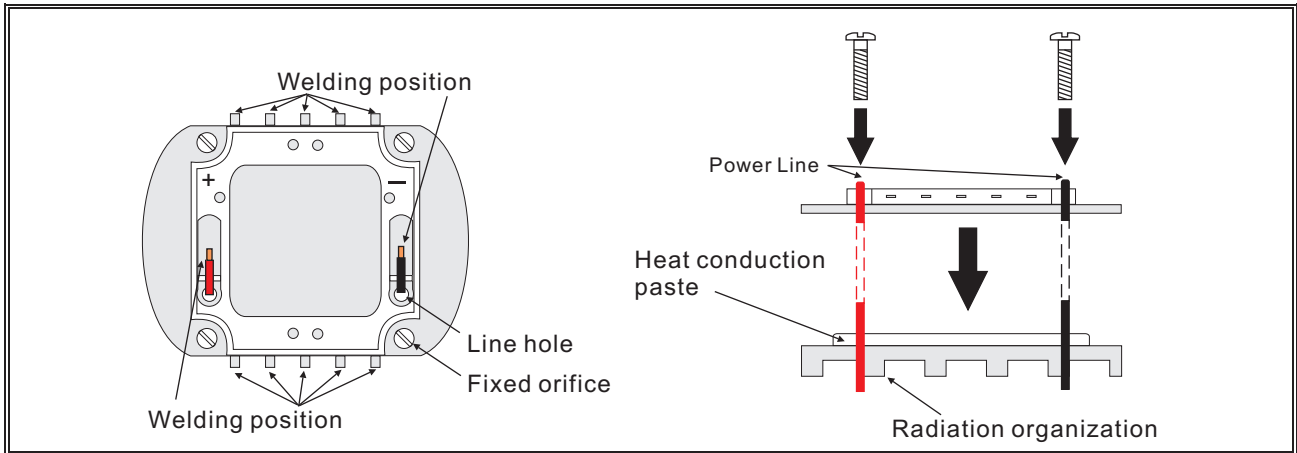

TEL:+886-4-26393976 FAX:+886-4-26393125

POSITION EXPLANATION:



Conclusion

Huey Jann provide simple comparison table for High Power LED, you could find your request heat dissipation area from the following table.

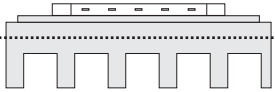
	 Free Convection Horizontal Flat Heat Dissipation-Set-up (Area Require mm ²)	 Free Convection Vertical Flat Heat Dissipation-Set-up (Area Require mm ²)	 Free Convection Finned Heat Dissipation-Set-up (Area Require mm ²)
Green	141,000	105,000	490,500
Yellow	73,000	54,500	254,000
Red	47,500	35,500	164,000
Blue	103,000	76,500	359,000

*TAB in this table is according to highest operating temperature 65°C.

*Different materials of second heat dissipation device, the surface area of heat sink will be different. Thus, this document is for reference only.



HUEY JANN ELECTRONICS INDUSTRY CO., LTD.

No.27 Line 466 Sec.2,Cannng-nan Rd. Wu-chi Town Taichung Shien, Taiwan, R.O.C.

TEL:+886-4-26393976 FAX:+886-4-26393125

PRODUCT APPLICATION

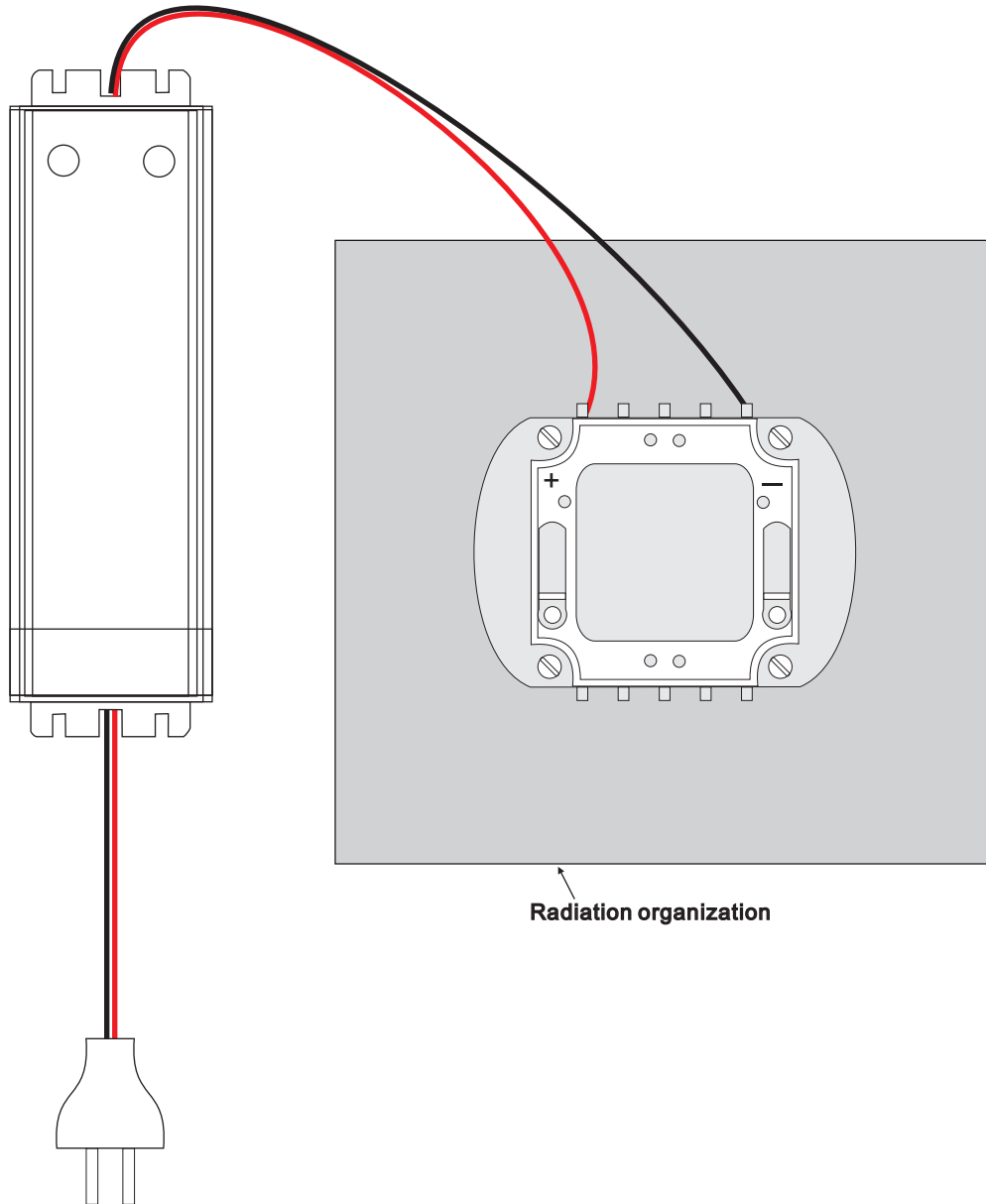

HUEY JANN ELECTRONICS INDUSTRY CO., LTD.

No.27 Line 466 Sec.2,Cannng-nan Rd. Wu-chi Town Taichung Shien, Taiwan, R.O.C.

TEL:+886-4-26393976 FAX:+886-4-26393125

100W Operating Instructions

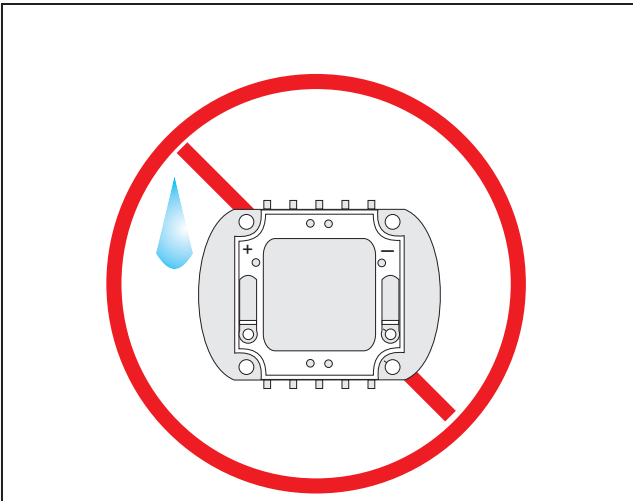

1. It is important to keep away the product from water, in order to avoid the product electronic characteristics to be harmful.

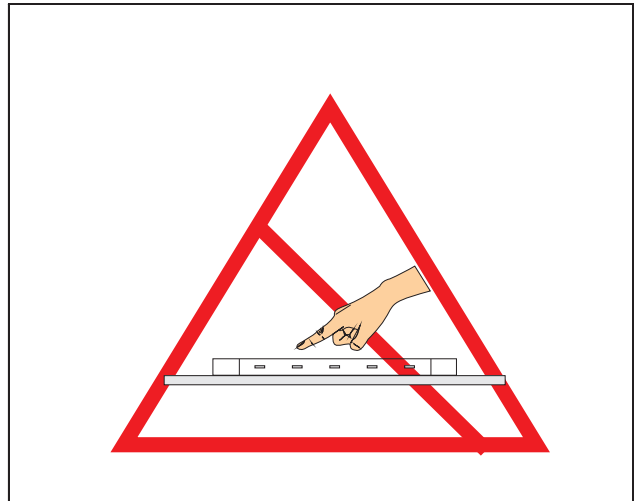

2. When making use of products, it is necessary to use anti-ESD devices to prevent destructive electronic characteristics.

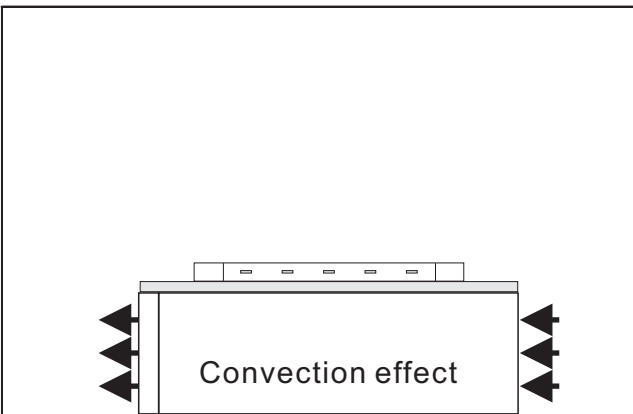

3. It should be noticed whether there is convection in design of device. Convection has to exist.

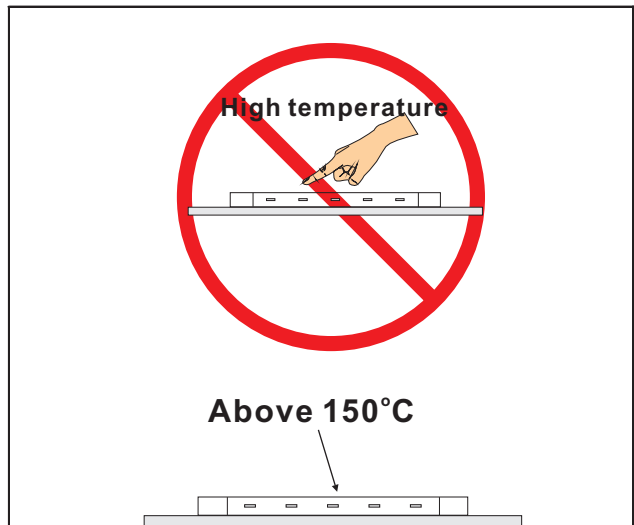

4. There is 150 C directly from the front of 100W emitting diode. It is untouchable to prevent burning.



HUEY JANN ELECTRONICS INDUSTRY CO., LTD.

No.27 Line 466 Sec.2,Cannng-nan Rd. Wu-chi Town Taichung Shien, Taiwan, R.O.C.

TEL:+886-4-26393976 FAX:+886-4-26393125

100W Operating Instructions

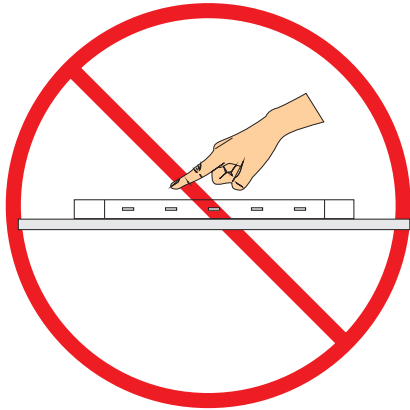

5. The material in the central top of 100W LED is soft. Therefore, it is un-squeezable and untouchable.

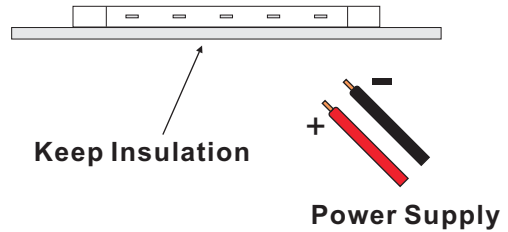

6. In the bottom of heat sink cannot be touched with neither positive nor negative pole. (Heat sink has to be insulation.)

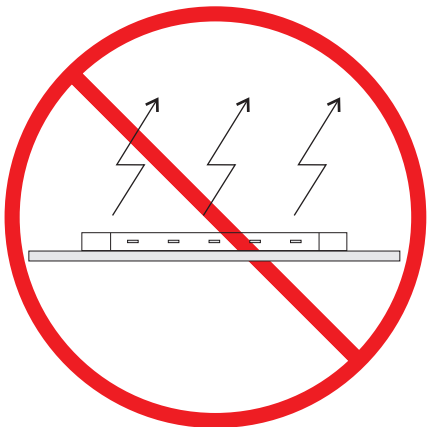

7. The product should not be light up directly without heat dissipation device.



HUEY JANN ELECTRONICS INDUSTRY CO., LTD.

No.27 Line 466 Sec.2,Cannng-nan Rd. Wu-chi Town Taichung Shien, Taiwan, R.O.C.

TEL:+886-4-26393976 FAX:+886-4-26393125

TAB Temperature - Life Characteristics Curves

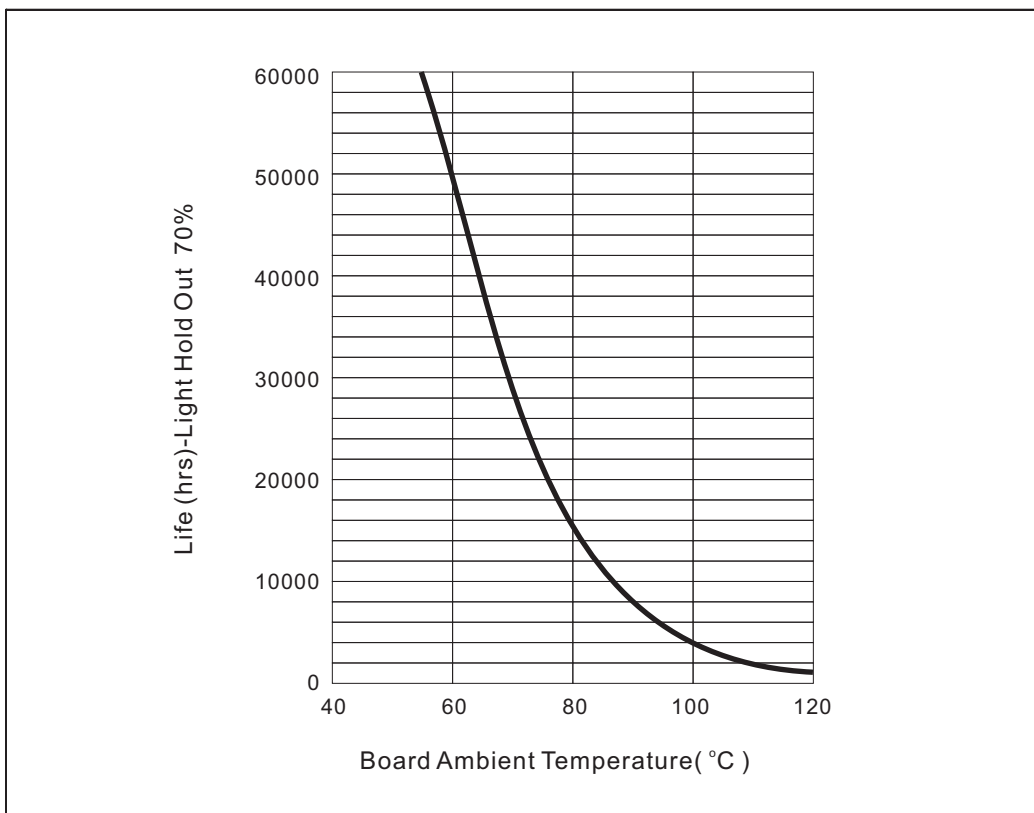
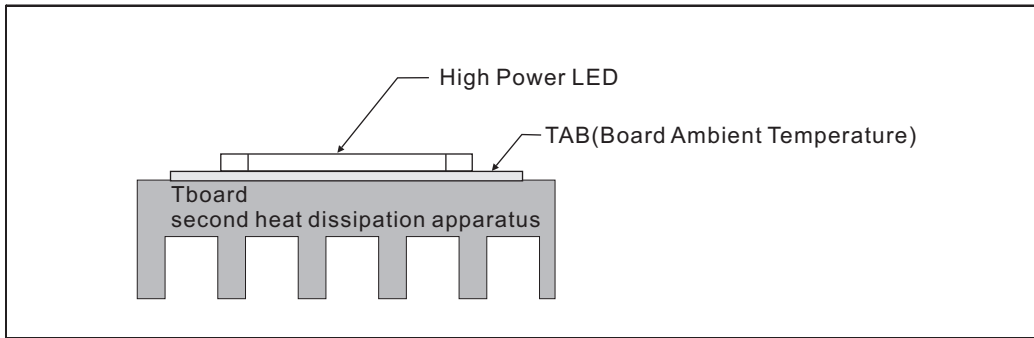

*Board Ambient Temperature Tolerance 5°C.

*TAB in this table is according to highest operating temperature 65°C.

*The TAB is the stable testing value for the product lighted 100% after one hour.

*Different materials of second heat dissipation device, the surface area of heat sink will be different. Thus, this document is for reference only.



HUEY JANN ELECTRONICS INDUSTRY CO., LTD.

No.27 Line 466 Sec.2,Cannng-nan Rd. Wu-chi Town Taichung Shien, Taiwan, R.O.C.

TEL:+886-4-26393976 FAX:+886-4-26393125

Remarks:

1. Brightness values are measured during a current pulse of typical 25 ms, the brightness tolerance is $\pm 15\%$.
2. Dominant wavelength are measured during a current pulse of typical 200 ms, the chromaticity tolerance is $\pm 1.0\text{nm}$.
3. Forward voltage are measured during a current pulse of typical 5 ms, the VF tolerance is $\pm 0.15\text{V}$.
4. Dimensions are specified as follows: mm.
5. Related technical parameters of LED are average value resulted from statistic. The actual parameters of LED could be slightly different from average and characteristic curve.
6. The average value of LED will be changed by technical improvement and elevation, and subject to change without prior notice.
7. Hi-Power LED can not be operated without second heat dissipating structure.
8. Poor or damaged second heat dissipating structure could lead to defective electrical characteristic of High Power LED, CCT escalation, brightness drop, lifetime shortening or burn out. Following instructions of Huey Jann Hi-Power LED series document can avoid LED burn out and electrical defectiveness due to improper usage, and maintain normal performance of the products.
9. For parts 50W Hi-Power LED or higher, since brightness is highly concentrated, due to conversion of light to heat, after continuously lighting up for 1000hrs, CCT will slightly increase and brightness will naturally decay.



HUEY JANN ELECTRONICS INDUSTRY CO., LTD.

No.27 Line 466 Sec.2,Cannng-nan Rd. Wu-chi Town Taichung Shien, Taiwan, R.O.C.

TEL:+886-4-26393976 FAX:+886-4-26393125