

## DETAILS

<b>Product Number</b>	FN14720_STELLA-FRESNEL
<b>Family</b>	STELLA
<b>Type</b>	Pack
<b>Color</b>	black
<b>Diameter</b>	90 mm
<b>Height</b>	23 mm
<b>Style</b>	round
<b>Optic Material</b>	Silicone
<b>Holder Material</b>	
<b>Fastening</b>	screw
<b>Status</b>	production ready
<b>ROHS Compliant</b>	Yes
<b>Date Updated</b>	15/02/2017



## OPTICAL PROPERTIES

LED	Viewing	Light	Effi-		Connector
	Angle	Beam	ciency	cd/lm	
VERO29	48 deg	Streetligh...	87 %	0.680	-
Vero SE 29	46 deg	Streetligh...	87 %	0.710	-
Vero SE 13	27 deg	Streetligh...	85 %	1.600	-
Vero SE 18	31 deg	Streetligh...	86 %	1.300	-
V10 Gen7	sim: 18	Streetligh...	sim: 85 %	sim: 4.010	Bender Wirth: 434 Typ Z1
V22 Gen7	sim: 30	Streetligh...	sim: 84 %	sim: 0.457	IDEAL: 50-2204CT
V18 Gen7	sim: 26	Streetligh...	sim: 85 %	sim: 1.970	BJB: 47.319.2350
V13 Gen7	sim: Asymmetri	Streetligh...	sim: 86 %	sim: 0.000	-
V22 Gen7	36 deg	Streetligh...	84 %	0.970	Bender Wirth: 431 Typ Z1
CLL04x/CLU04x	36 deg	Streetligh...	86 %	1.100	-
CLL05x/CLU05x	sim: 46	Streetligh...	sim: 91 %	sim: 0.840	-
CXA/B 3590	sim: 37	Streetligh...	sim: 83 %	sim: 1.100	-
CXA/B 25xx	sim: 24	Streetligh...	sim: 83 %	sim: 2.500	-
CXA/B 30xx	37 deg	Streetligh...	88 %	1.000	BJB: 47.319.2151
LUXEON CoB 1216	39 deg	Streetligh...	86 %	0.930	-
LUXEON CoB 1208	sim: 23	Streetligh...	sim: 82 %	sim: 2.800	-
CXM-22	38 deg	Streetligh...	86 %	0.930	Bender Wirth: 431 Typ L3
Soleriq P13	25 deg	Streetligh...	89 %	1.900	-
Soleriq S19	32,1 deg	Streetligh...	84 %	1.219	-
Fortimo SLM 1211 L19 G6 Poke-In	33 deg	Streetligh...	87 %	1.200	-
MJT COB LES 22	36 deg	Streetligh...	84 %	0.960	IDEAL: 50-2204CT
MJT COB LES 14.5	28 deg	Streetligh...	84 %	1.500	IDEAL: 50-2103CT
SLE G5 LES19	30 deg	Streetligh...	86 %	1.360	-
SLE G5 LES23	35 deg	Streetligh...	86 %	1.050	-

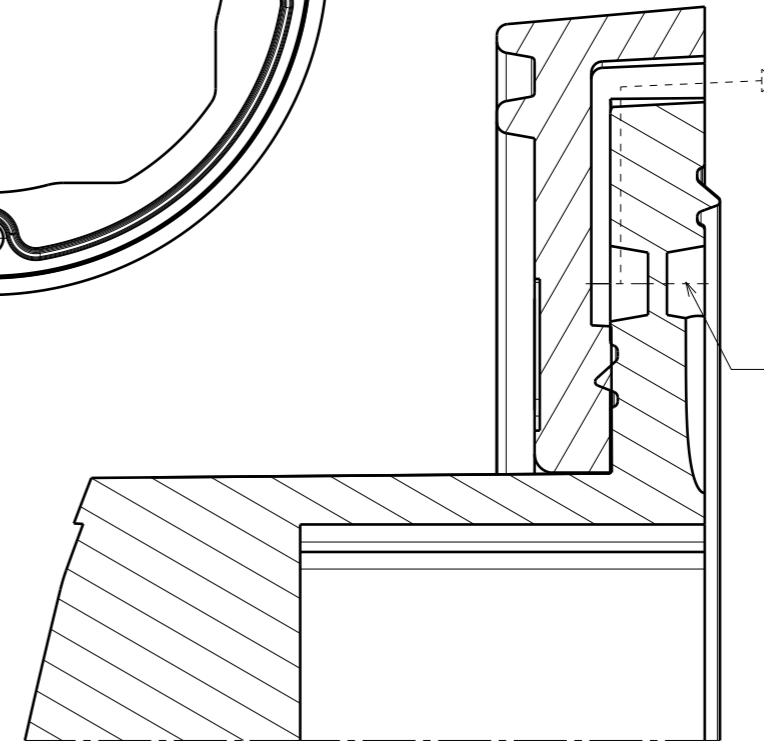
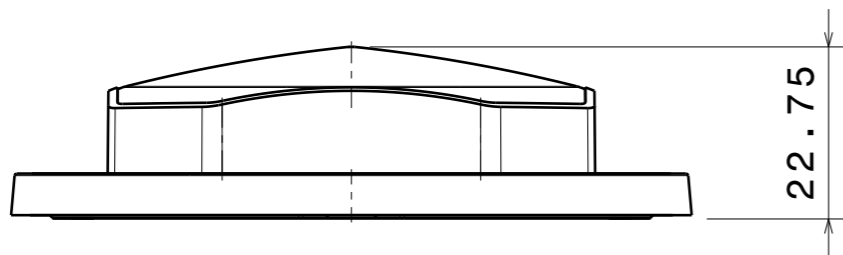
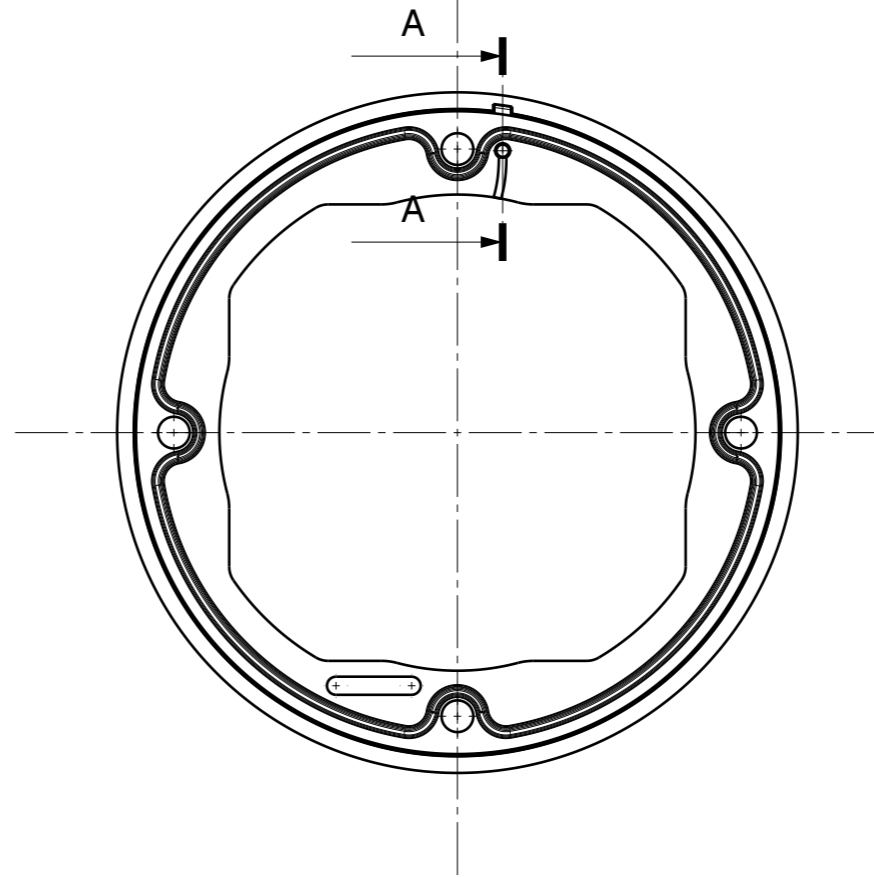
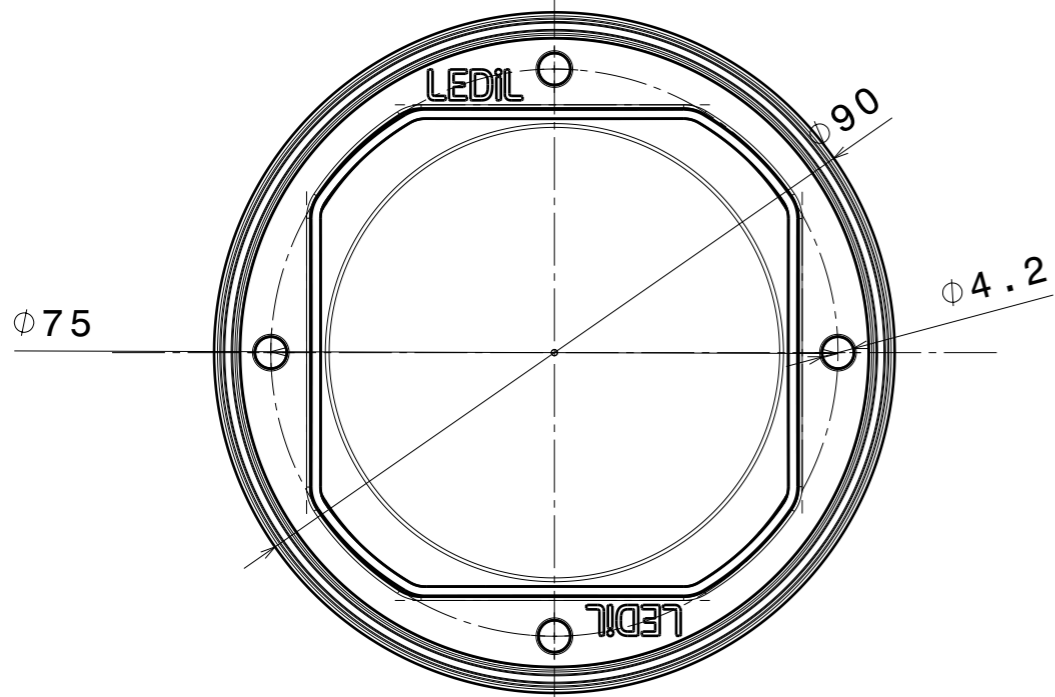

Section view A-A  
Scale: 5:1

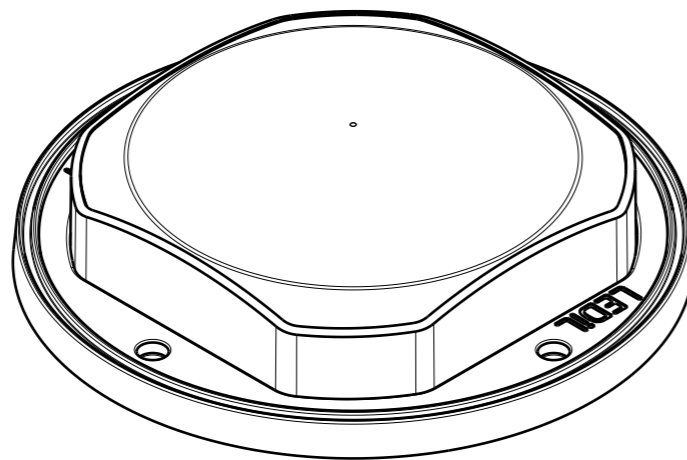

Isometric view  
Scale: 1:1

INDEX	PART NO	DESCRIPTION	MATERIAL	COLOUR
1	F14627	STELLA-FRESNEL	Optical grade LSR	
	F13322	STELLA-FRAME	PA66GF30	black

Tolerances if not otherwise shown  
According to DIN ISO 2768-1  
Linear measures: class V  
Please note that due to the elasticity of  
products made of silicone actual measured  
values may vary, and therefore typical  
tolerance values may not be applied.



Ledil Oy  
Salorankatu 10  
FIN 24240 SALO  
Finland

THIRD ANGLE PROJECTION:

DRAWING TITLE  
FN14720\_STELLA-FRESNEL

This drawing is the property  
of LEDiL Oy. It may not be  
reproduced, copied or  
communicated without a written  
agreement with LEDiL Oy.

SIZE	PART NUMBER
A3	FN14720

SCALE	1:1	WEIGHT	35 g	SHEET	1/1
-------	-----	--------	------	-------	-----

Luminaire: Ledil FN14720\_STELLA-FRESNEL\_(Vero29)

Lamps: 1 x Bridgelux\_Vero29\_(30-E10K0L-Y2)\_1467.5lm@250mA\_P=8.8850W\_I=0.25A

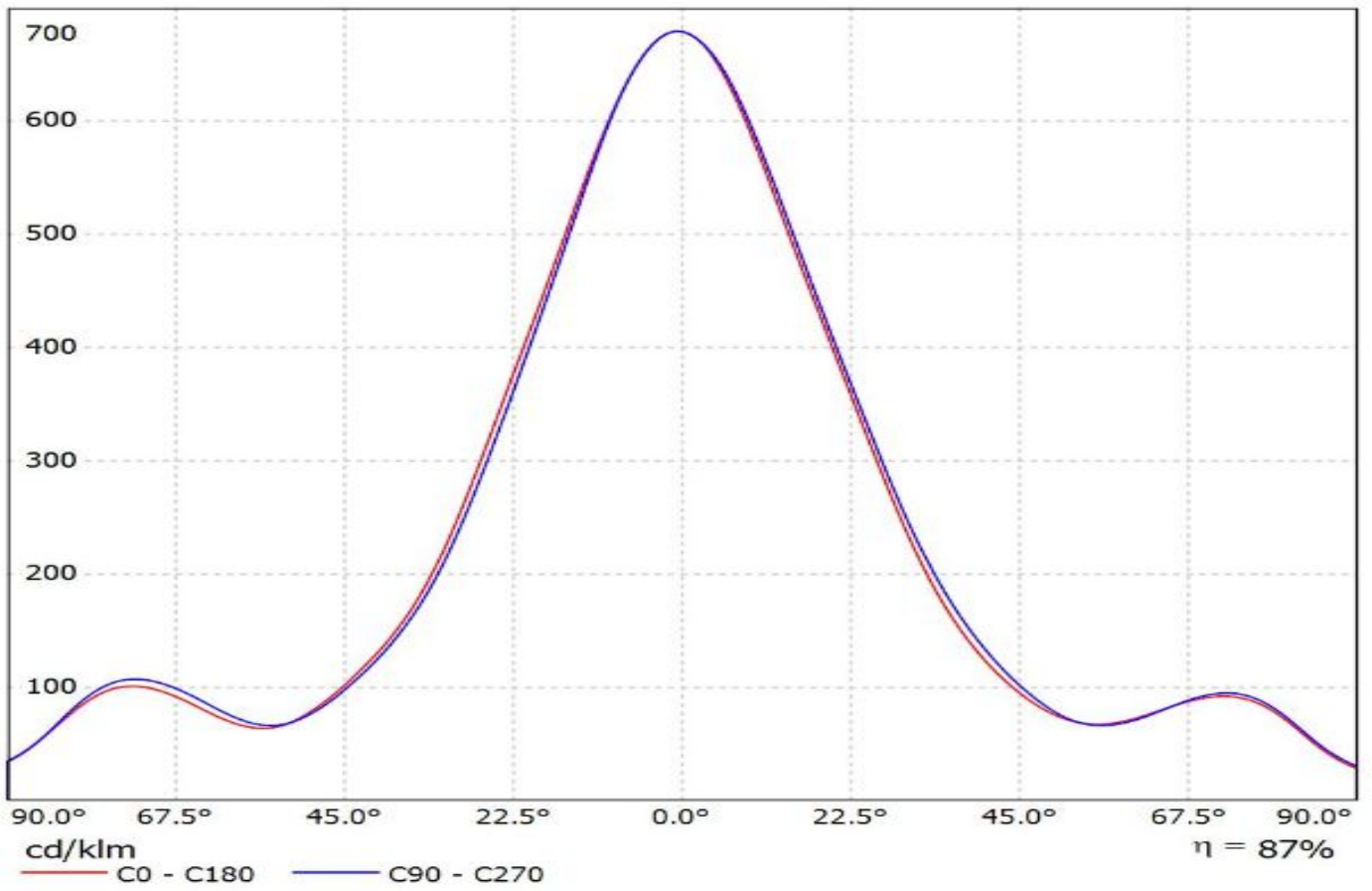

Luminaire: Ledil FN14720\_STELLA-FRESNEL\_(Vero29\_SE\_Gen7)  
Lamps: 1 x Vero29\_SE\_Gen7\_1750.87lm@250mA\_P=8.5765\_I=0.25A

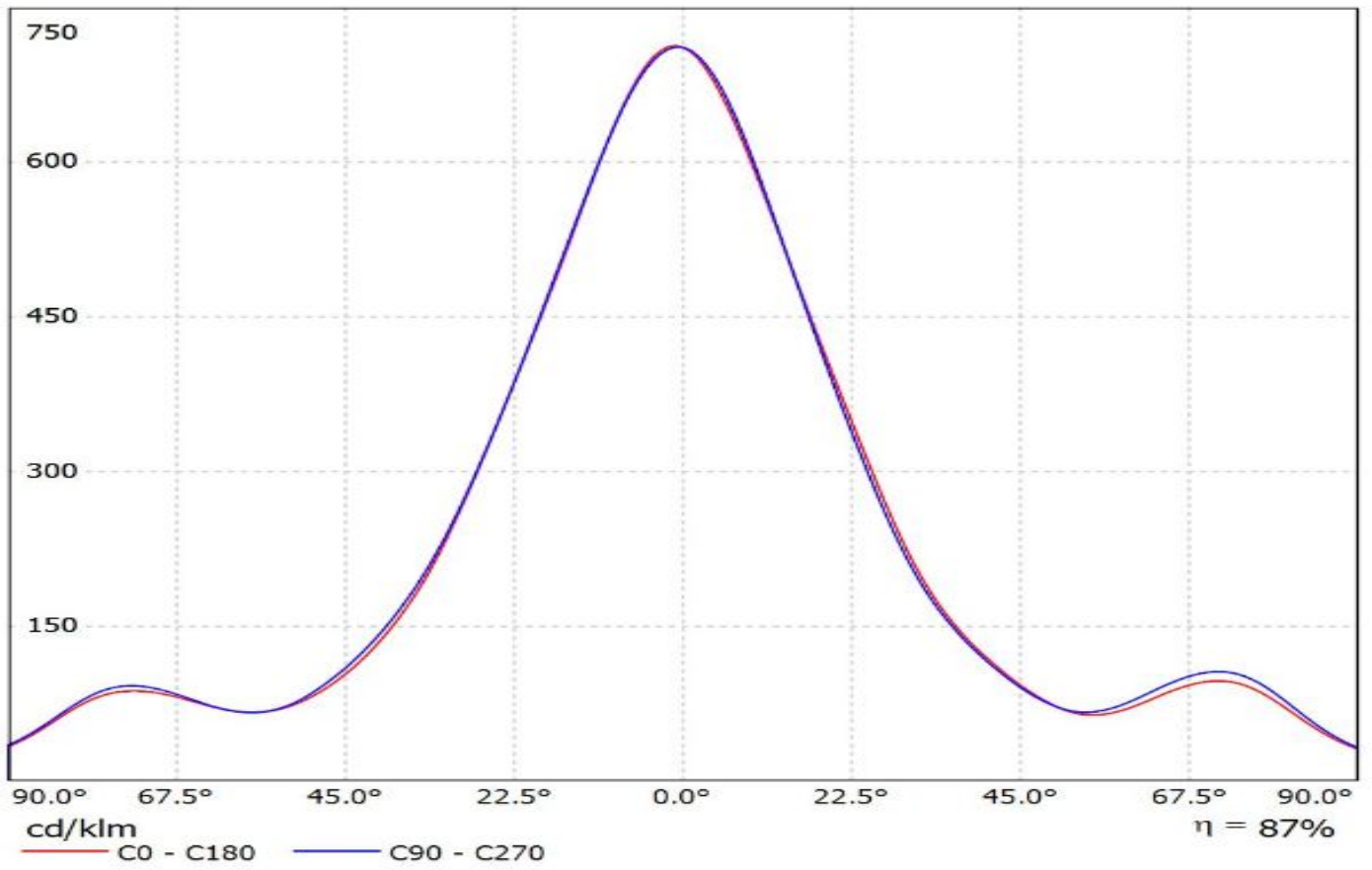

Luminaire: Ledil FN14720\_STELLA-FRESNEL\_(Vero\_13\_SE)  
Lamps: 1 x Bridgelux\_Vero\_13\_SE\_(BXRC-30E2000-C-73-SE)  
\_1310.97lm@250mA\_CCT=3000K\_P=8.17575W\_I=0.25A

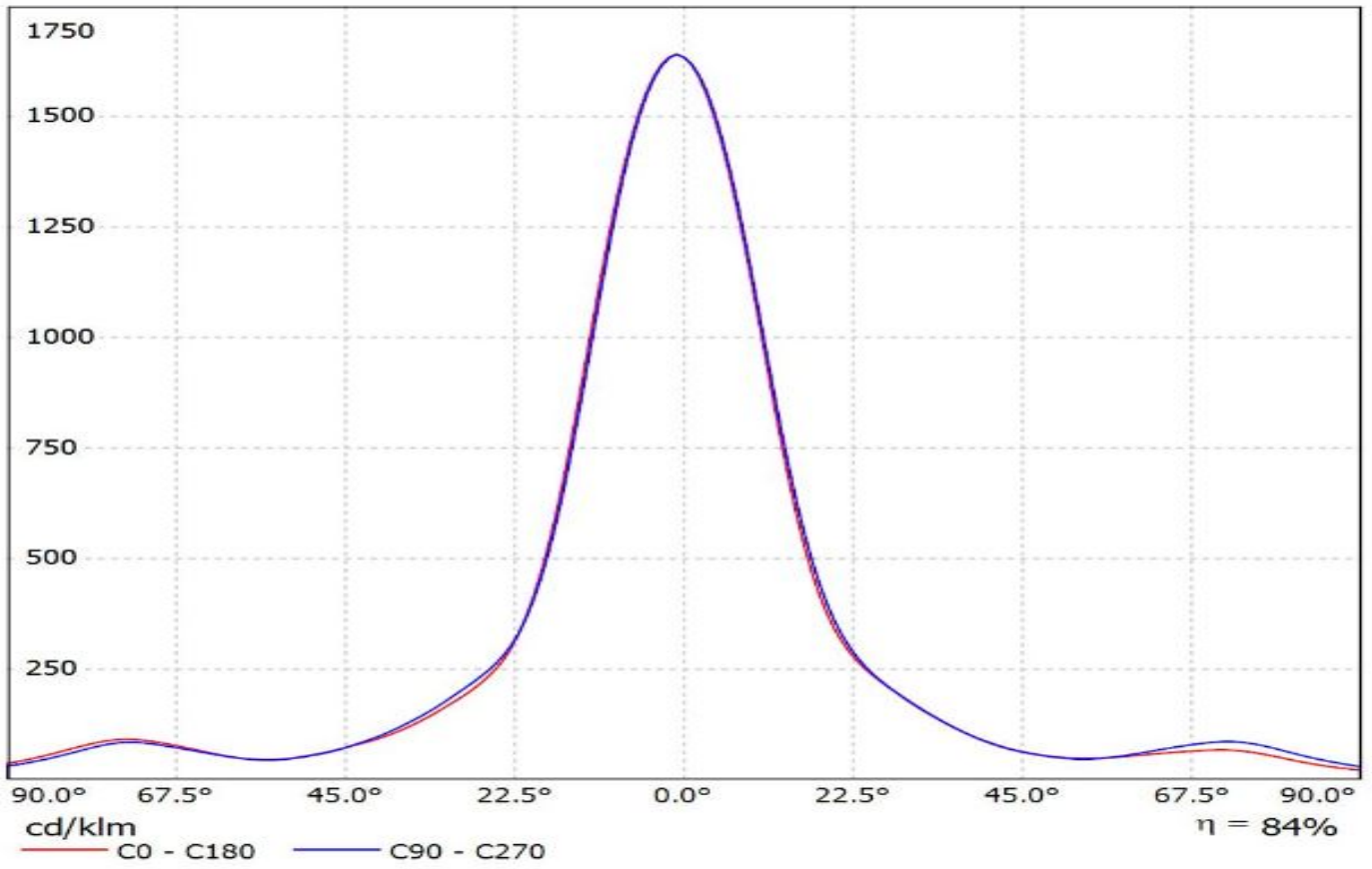

Luminaire: LEDiL Oy FN14720\_STELLA-FRESNEL\_(VERO18\_SE)  
Lamps: 1 x Bridgelux\_VERO18\_SE\_(BXRC-30E4000-C-73-SE)  
\_1335.46lm@250mA\_P=7.9961W\_I=0.25A

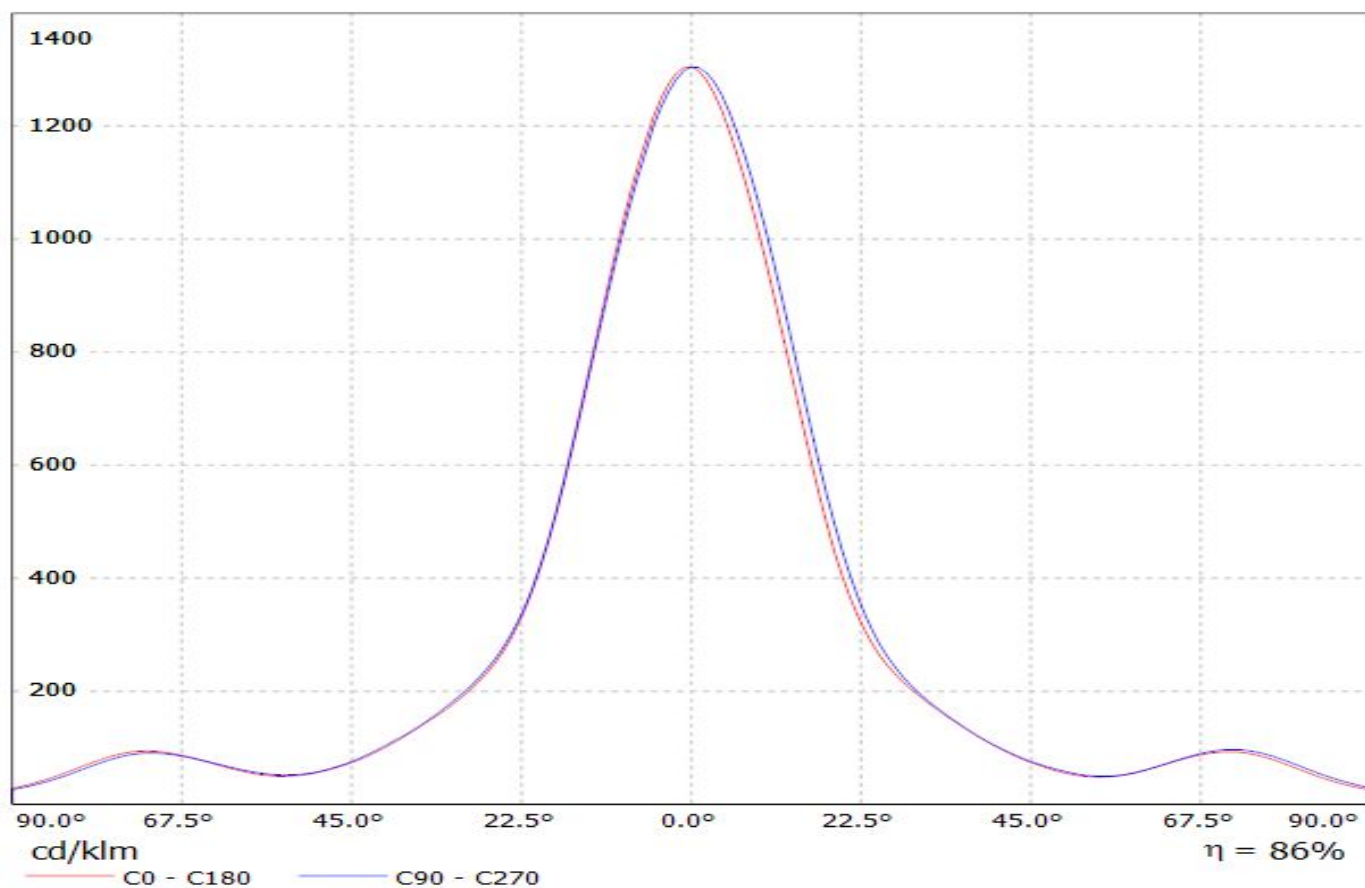

Luminaire: Ledil Oy FN14720\_STELLA-FRESNEL+\_Bender+Wirth 434 TypL1\_BRIDGELUX\_V10\_Gen7\_SIMULATED  
Lamps: 1 x BRIDGELUX V10 Gen7

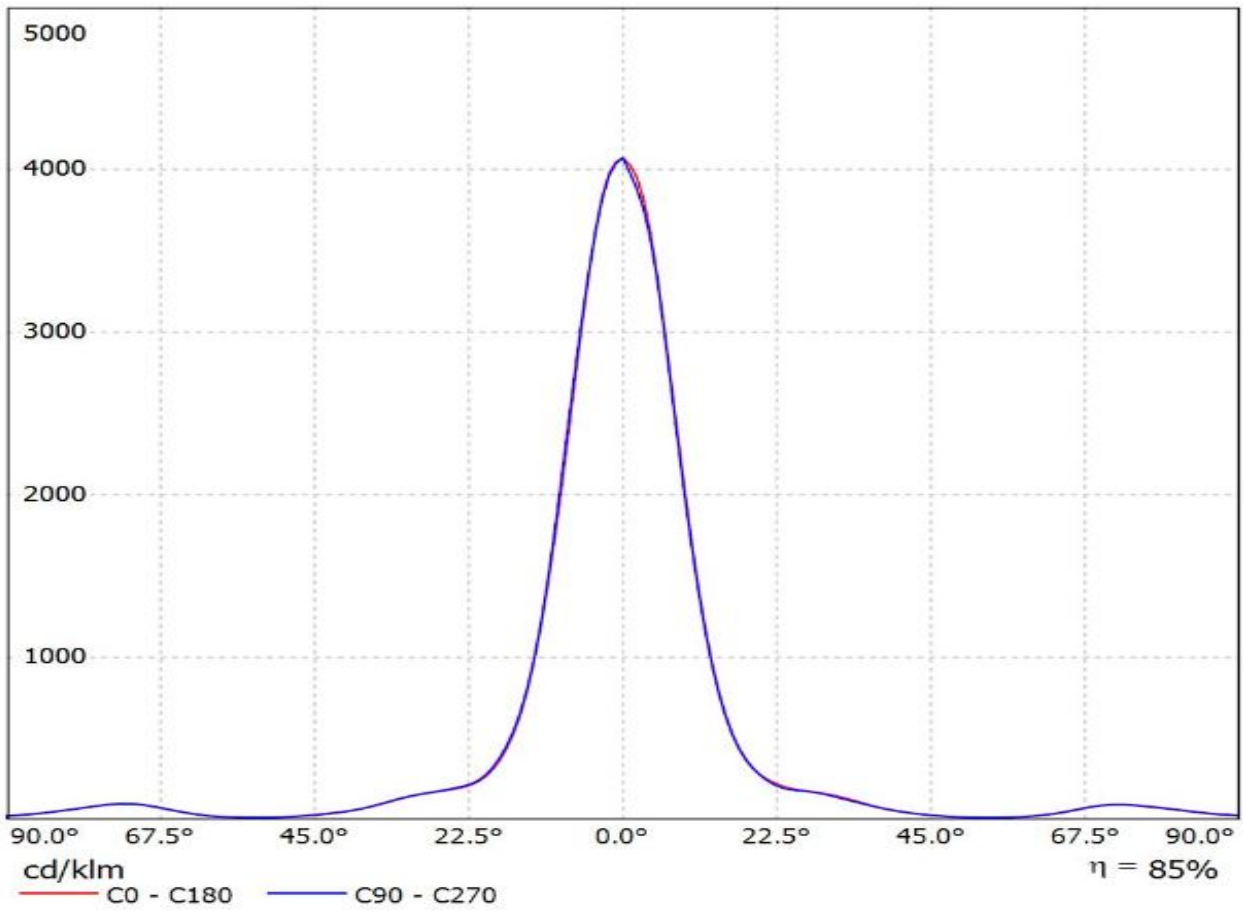

Luminaire: Ledil Oy FN14720\_STELLA-FRESNEL\_Bridgelux\_V22\_Gen7\_SIMULATED FN14720\_STELLA-FRESNEL\_Bridgelux\_V22\_Gen7\_SIMULATED  
Lamps: 1 x FN14720\_STELLA-FRESNEL\_Bridgelux\_V22\_Gen7\_SIMULATED

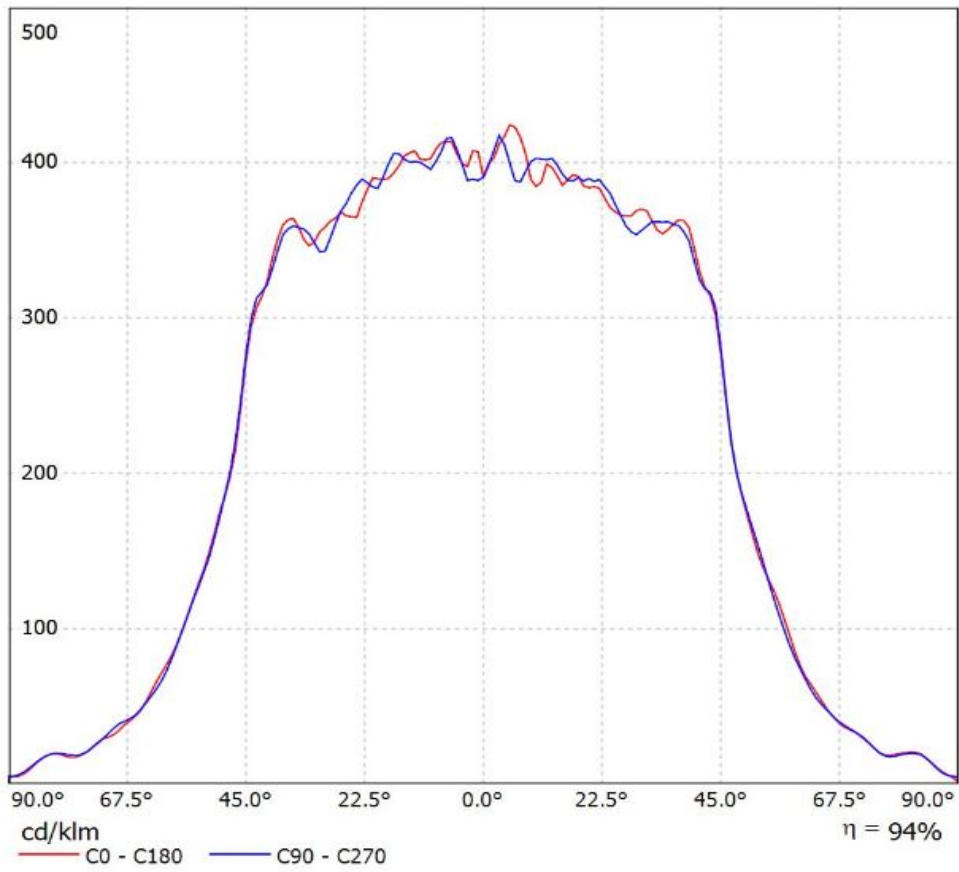



Luminaire: Ledil Oy FN14720\_STELLA-FRESNEL\_+\_BJB\_47\_319\_2350\_BRIDGELUX\_V18\_Gen7\_SIMULATED  
Lamps: 1 x BRIDGELUX V18 Gen7

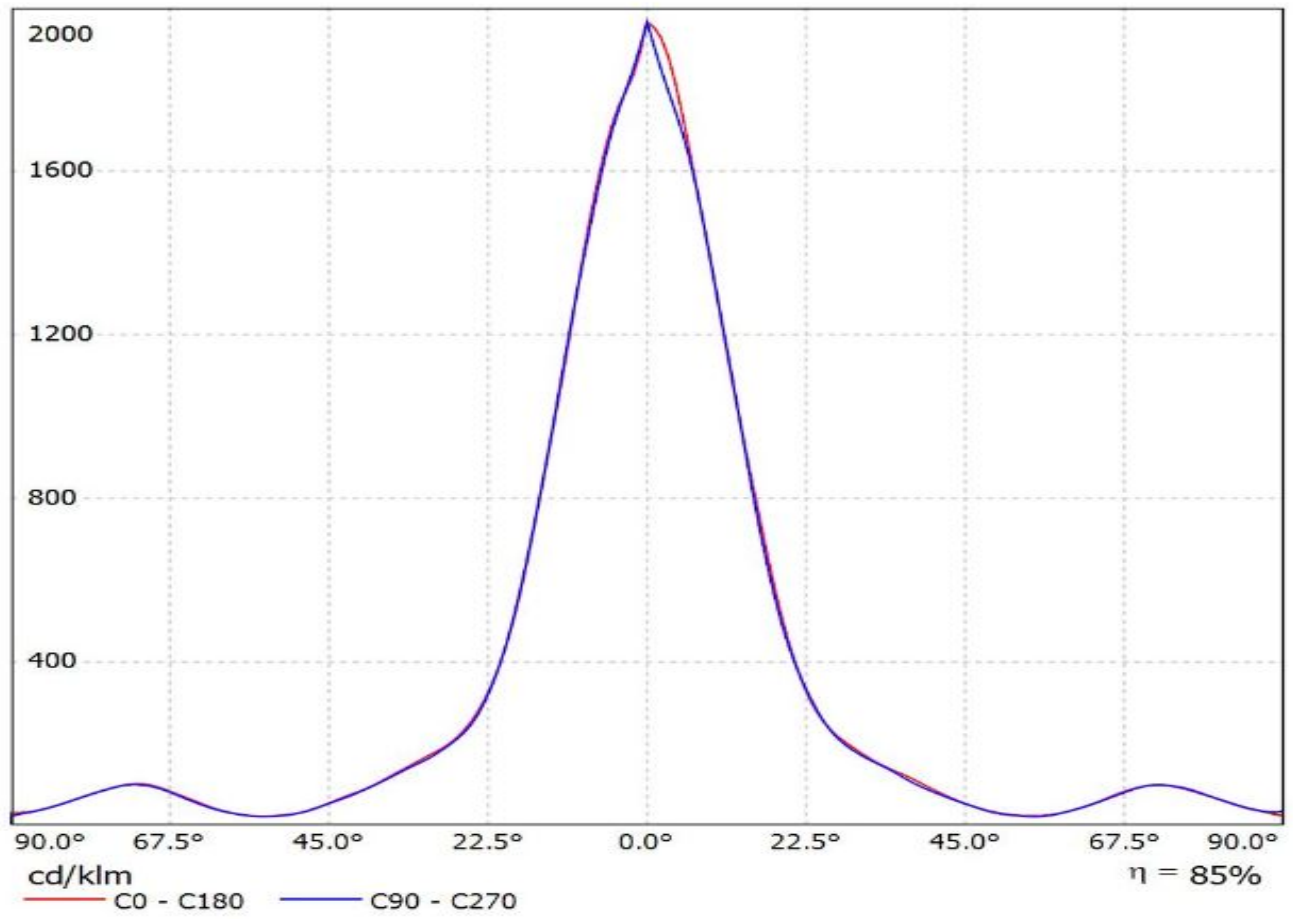

Luminaire: LEDiL Oy FN14720-STELLA-FRESNEL\_(V22\_Gen7+BW)  
Lamps: 1 x Bridgelux\_V22\_Gen7\_(BXRE-30E6500-B)  
+BW431\_TypZ1\_2036.72lm@250mA\_P=11.891W\_I=0.250A

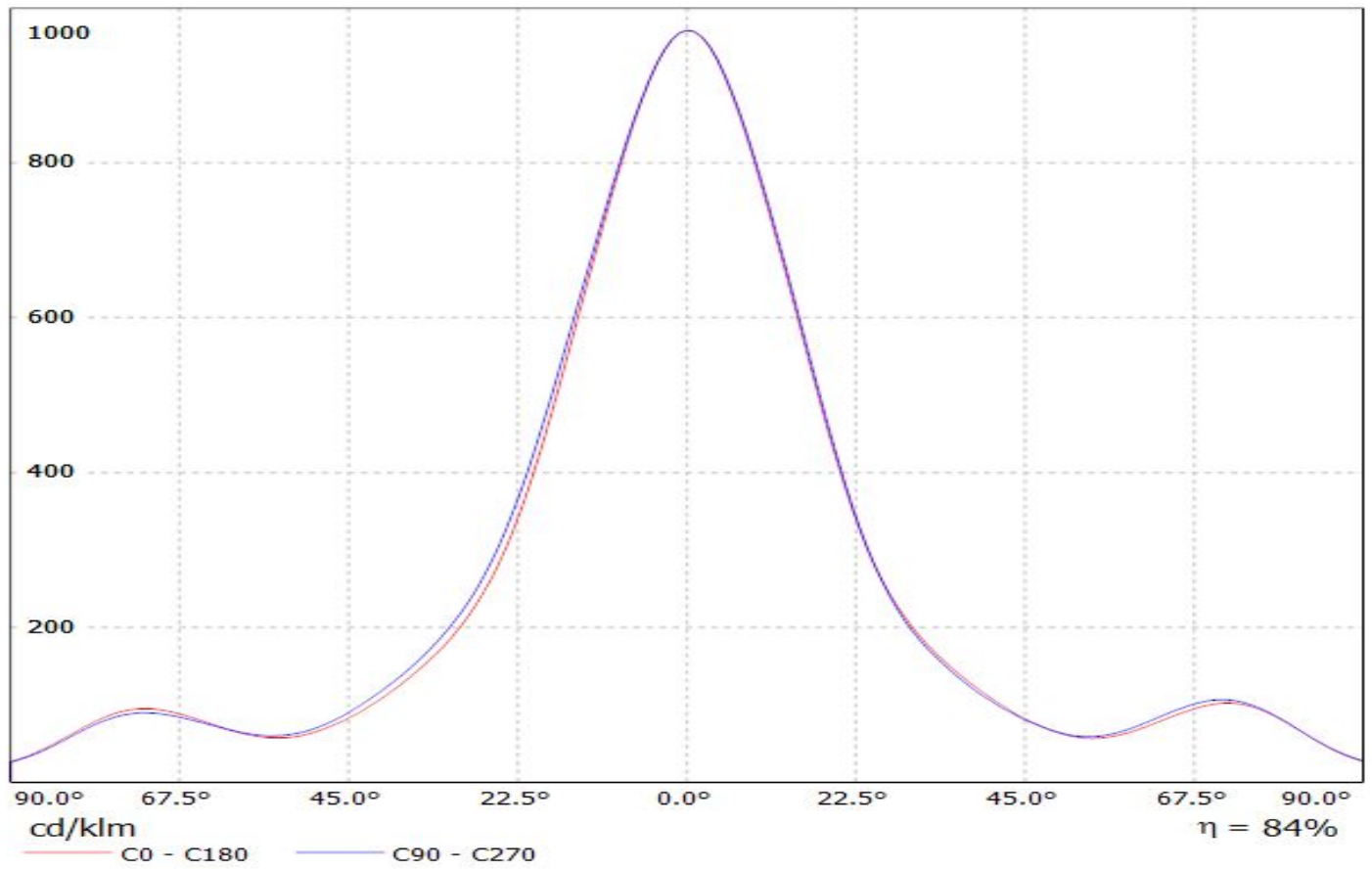

Luminaire: LEDiL Oy FN14720\_STELLA-FRESNEL\_(CLU046)  
Lamps: 1 x Citizen\_CLU046\_1354.66lm@250mA\_P=8.06877W\_I=0.2499A

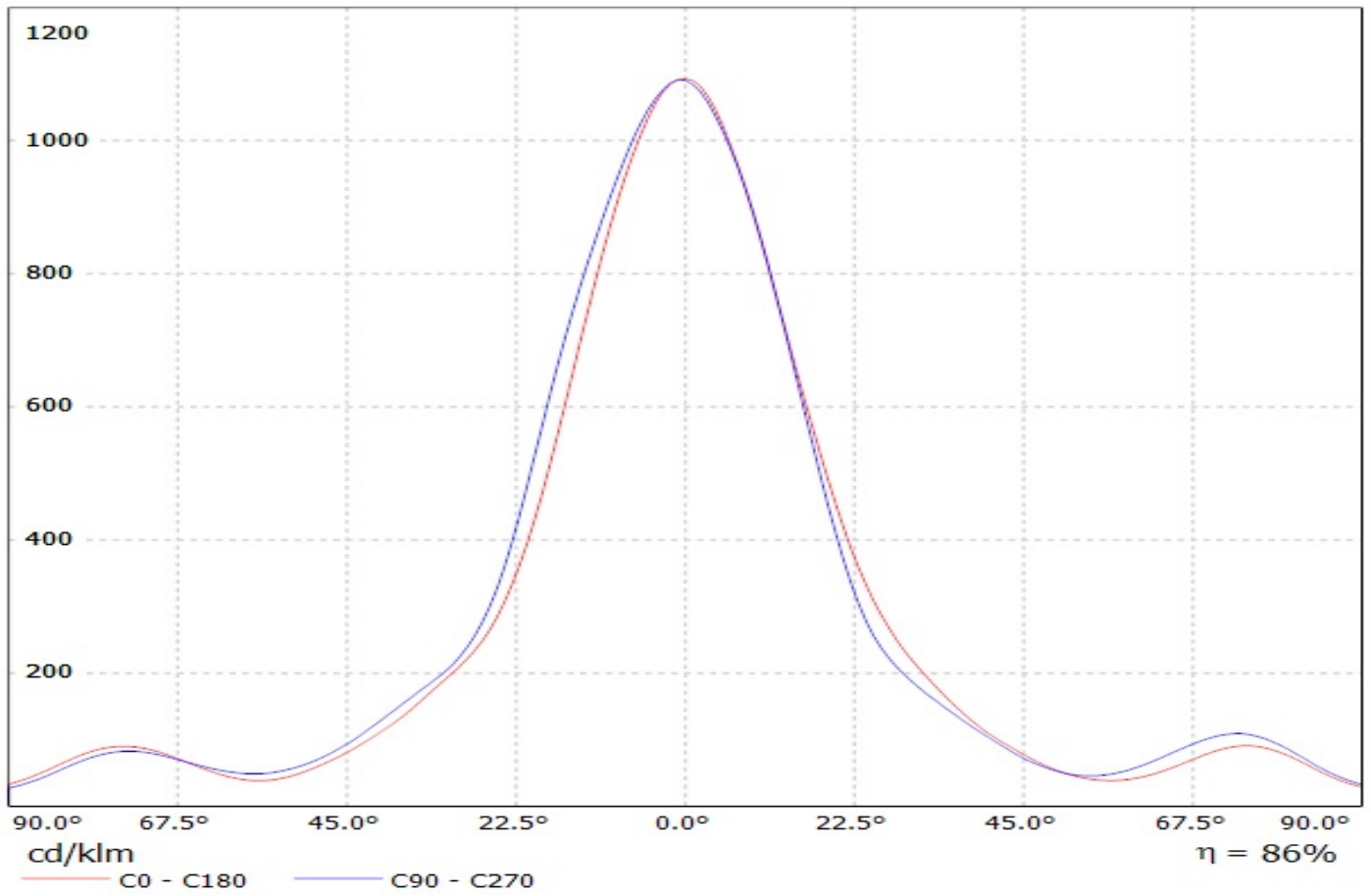

Luminaire: Ledil Oy FN14720\_STELLA-FRESNEL\_(CITIZEN\_CLU05x)\_SIMULATED  
Lamps: 1 x CITIZEN\_CLU054

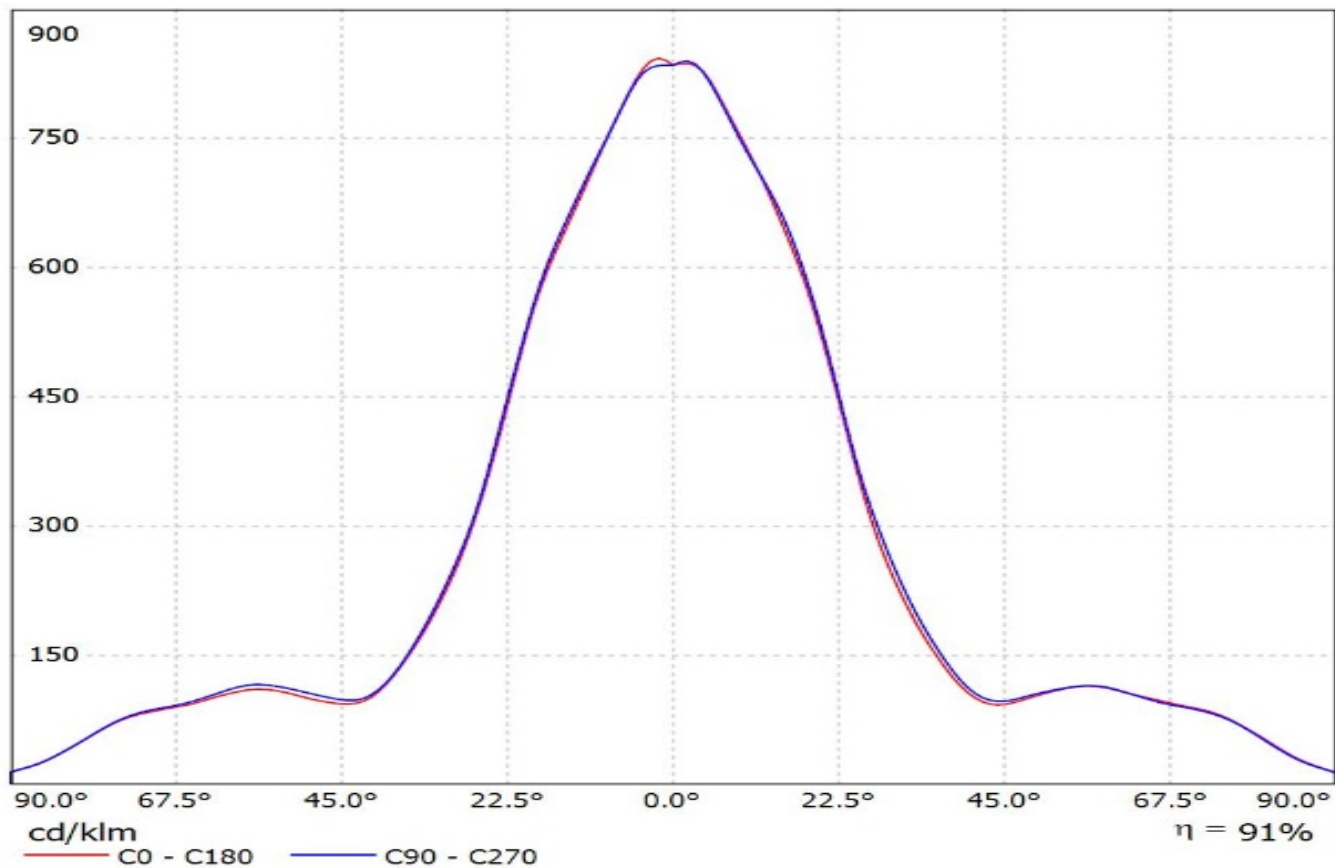

Luminaire: Ledil Oy FN14720\_STELLA-FRESNEL\_(CXA3590)\_SIMULATED  
Lamps: 1 x Cree CXA3590

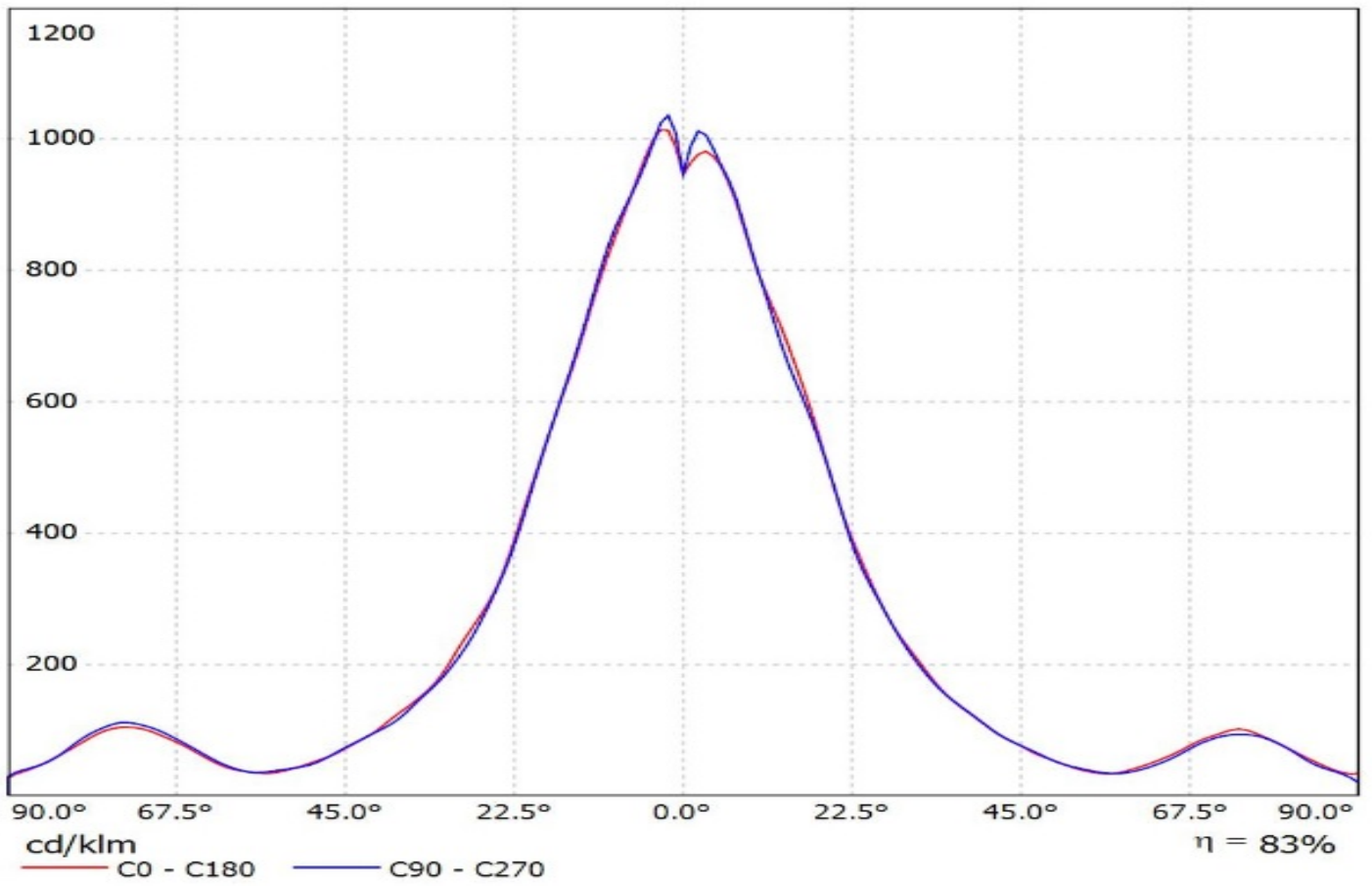

Luminaire: Ledil Oy FN14720\_STELLA-FRESNEL\_(CXA2590)\_SIMULATED  
Lamps: 1 x Cree CXA2590

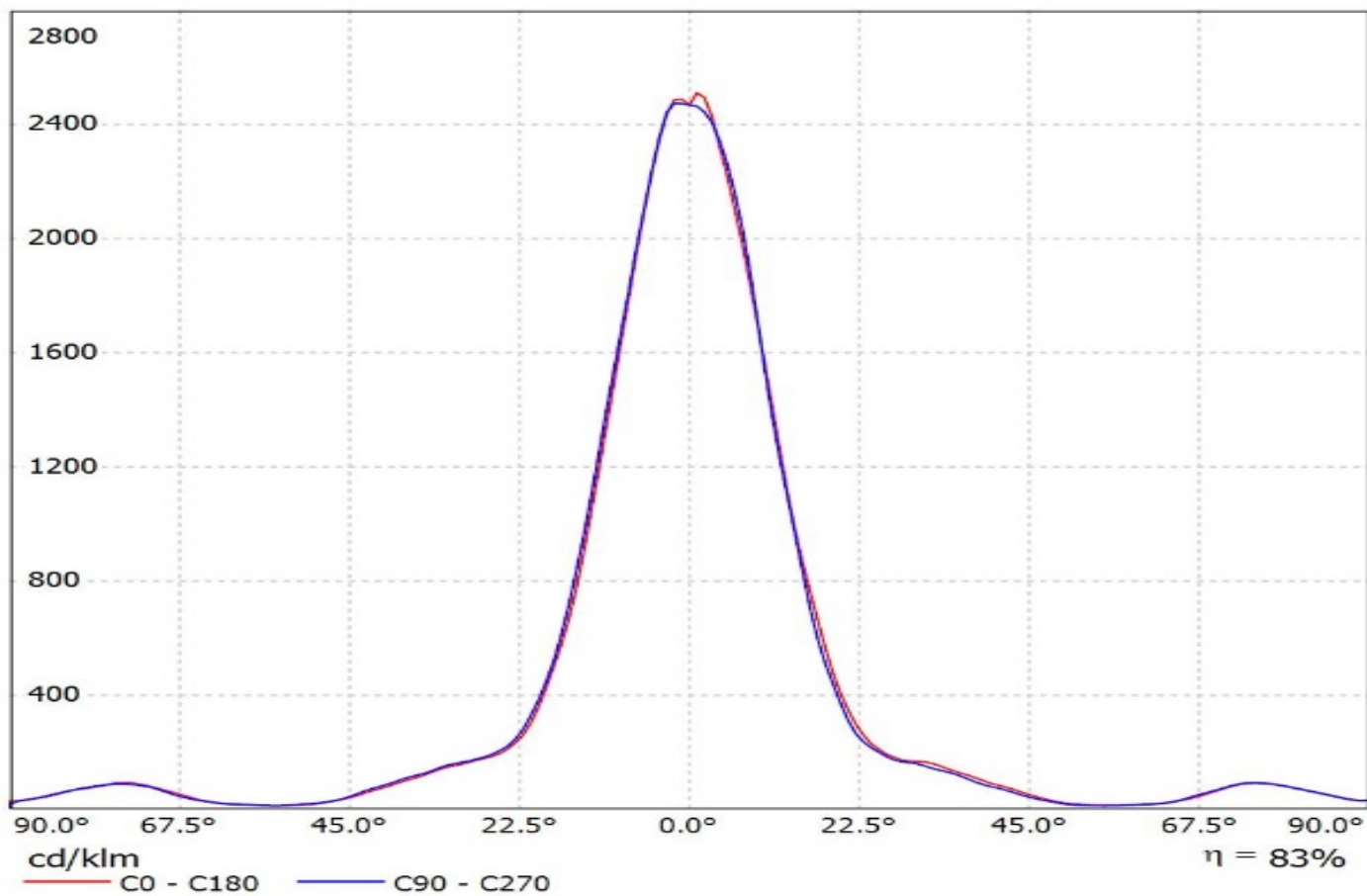

Luminaire: Ledil FN14720\_STELLA-FRESNEL (CXB3070 +BJB)

Lamps: 1 x Cree\_CXB3070\_(-30G-AD-N0H-0001)\_+BJB\_47.319.2150\_1399.52lm@250mA\_CCT=3000K\_P=8.0355W\_I=0.25A

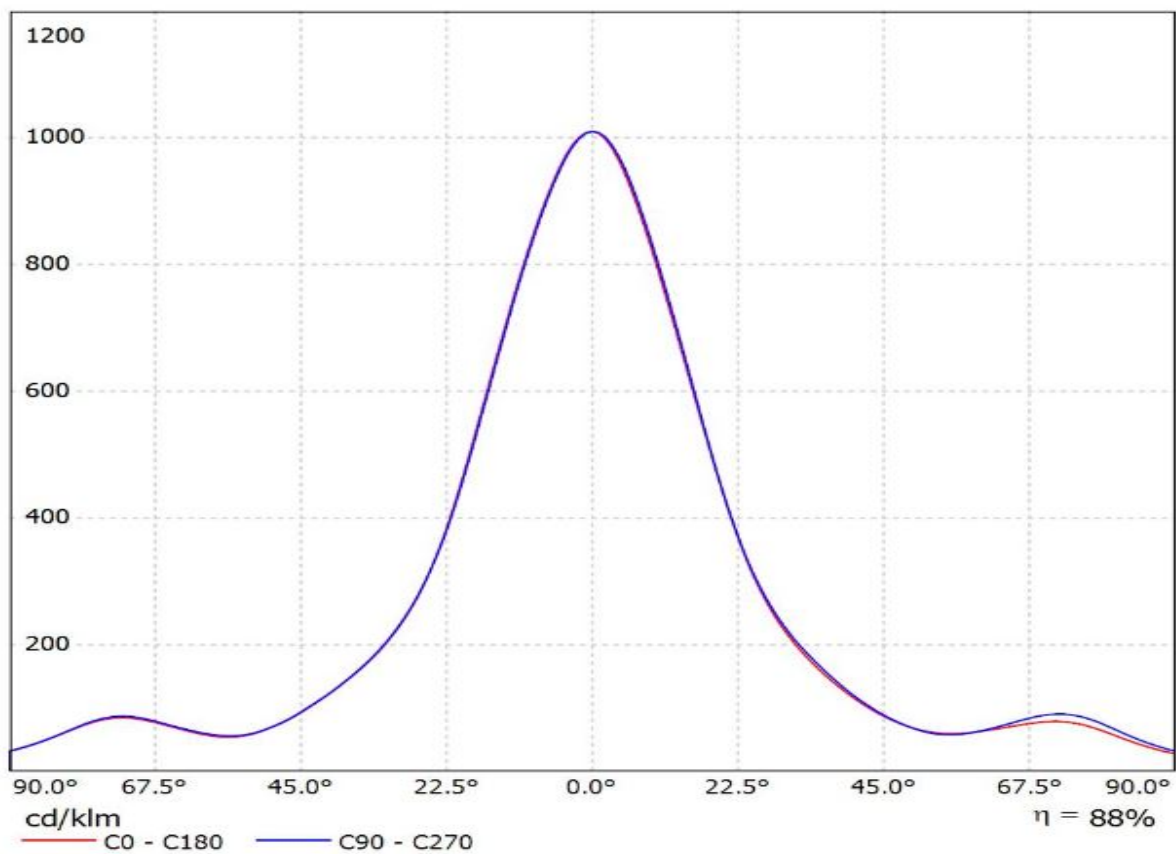

Luminaire: Ledil FN14720\_STELLA-FRESNEL\_(CoB\_1216)

Lamps: 1 x Luxeon\_CoB\_1216\_(L2C2-40801216E2300)\_1468.12lm@250mA\_P=7.9868W\_η=0.25A

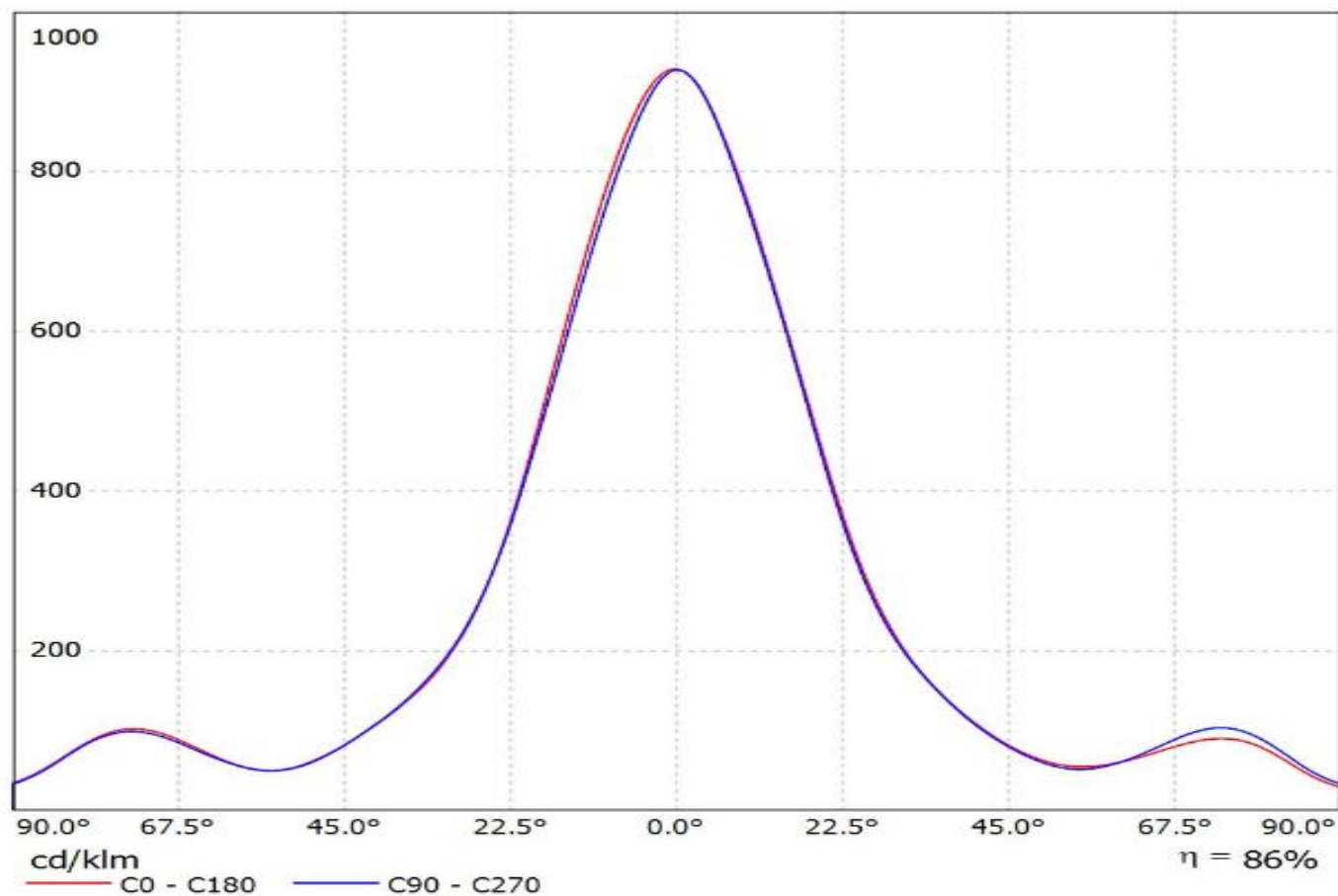



Luminaire: Ledil Oy FN14720\_STELLA-FRESNEL\_(Luxeon\_CoB\_1208)\_SIMULATED  
Lamps: 1 x Lumileds Luxeon CoB 1208

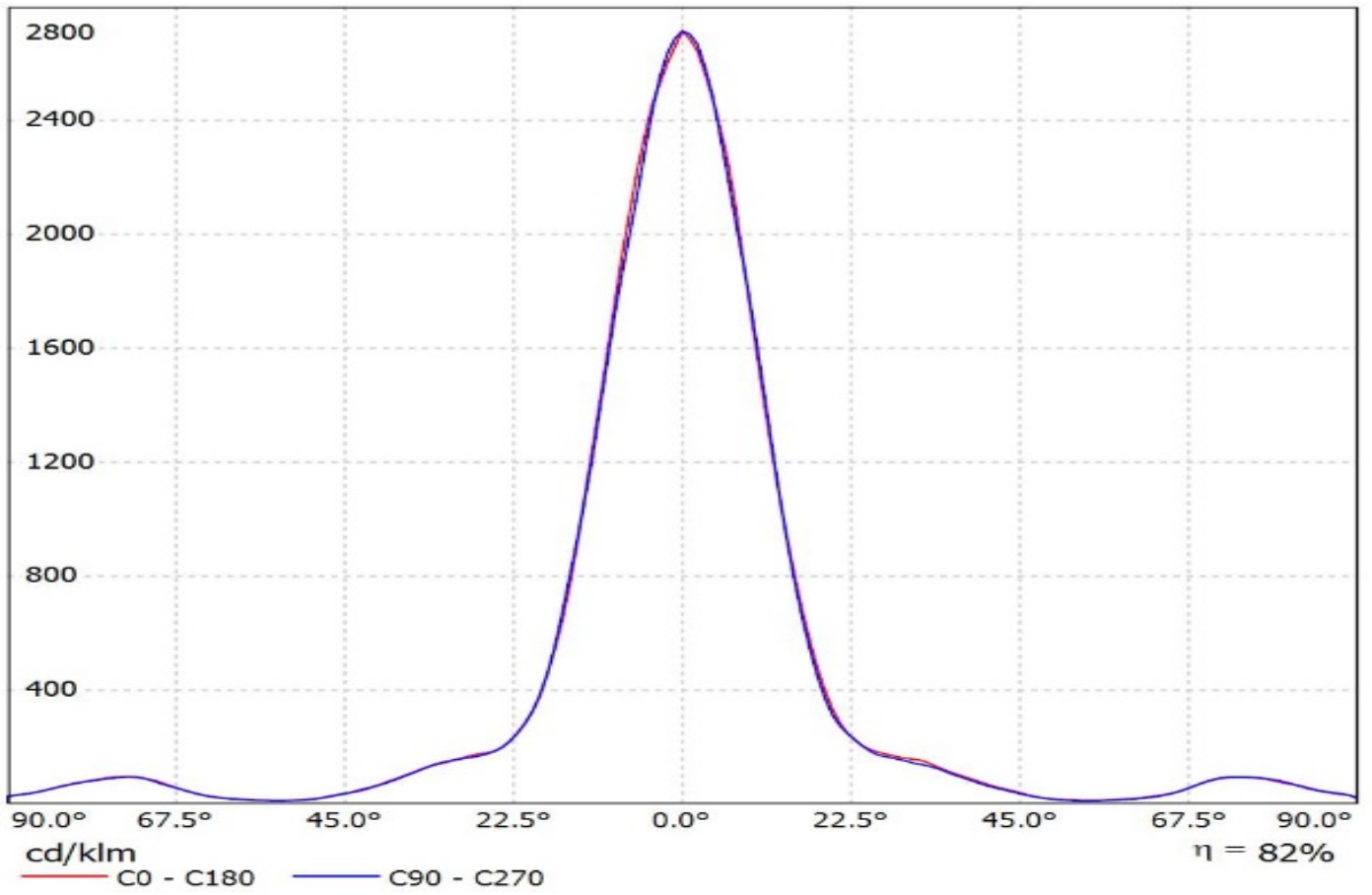

Luminaire: Ledil FN14720\_STELLA-FRESNEL\_(CXM-22\_+BW)  
Lamps: 1 x LUMINUS\_CXM-22\_+Bender&Wirth\_431TypL3\_1259.61lm@250mA\_P=8.0332W\_CCT=3000K\_I=0.25A

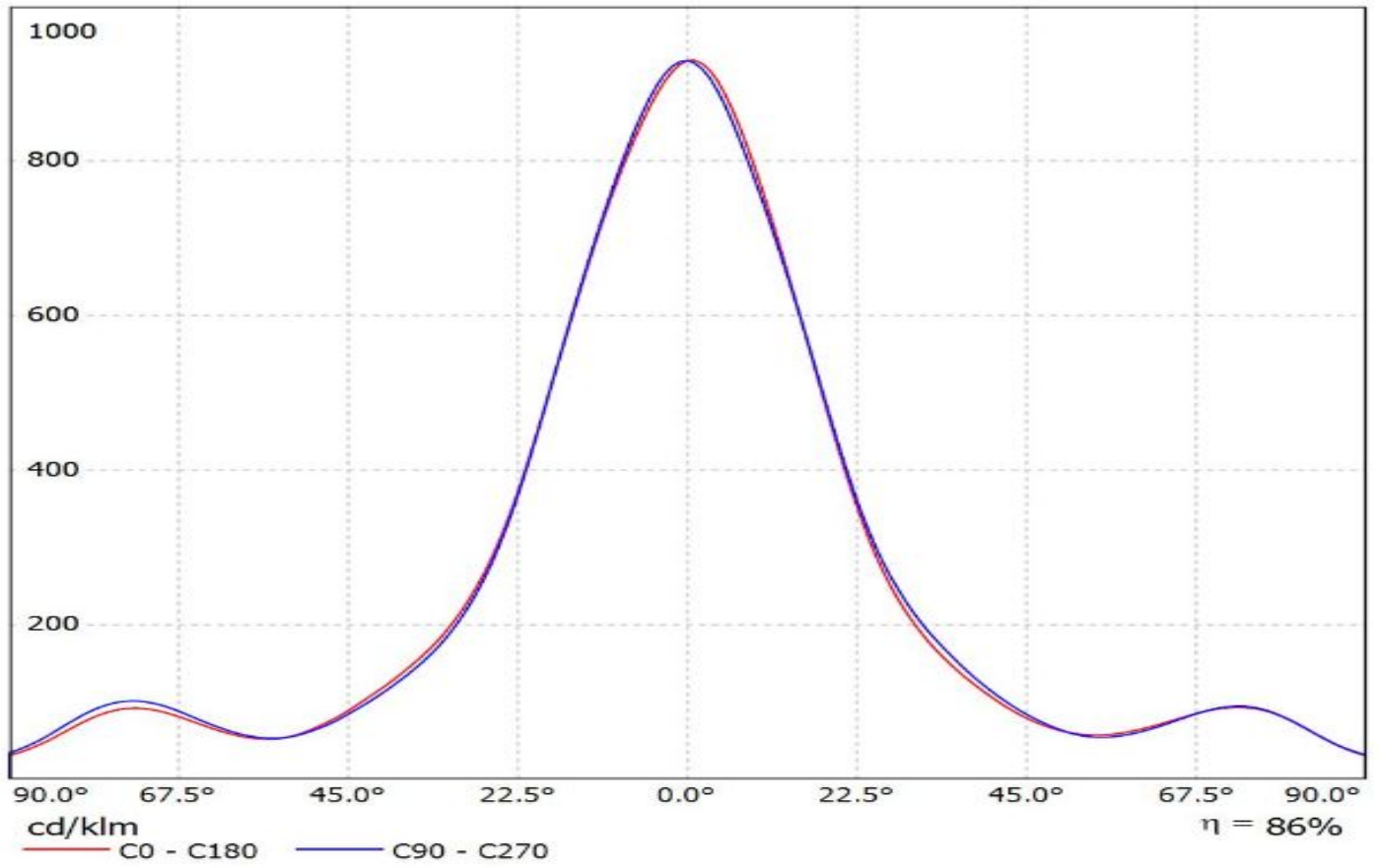

Luminaire: LEDiL Oy FN14720\_STELLA-FRESNEL\_(Soleriq\_P13)\_Cav1

Lamps: 1 x Osram\_Soleriq\_P13\_(GQ\_MAGMB1.EM)\_922.464lm@250mA\_P=8.69804W\_I=0.2498A

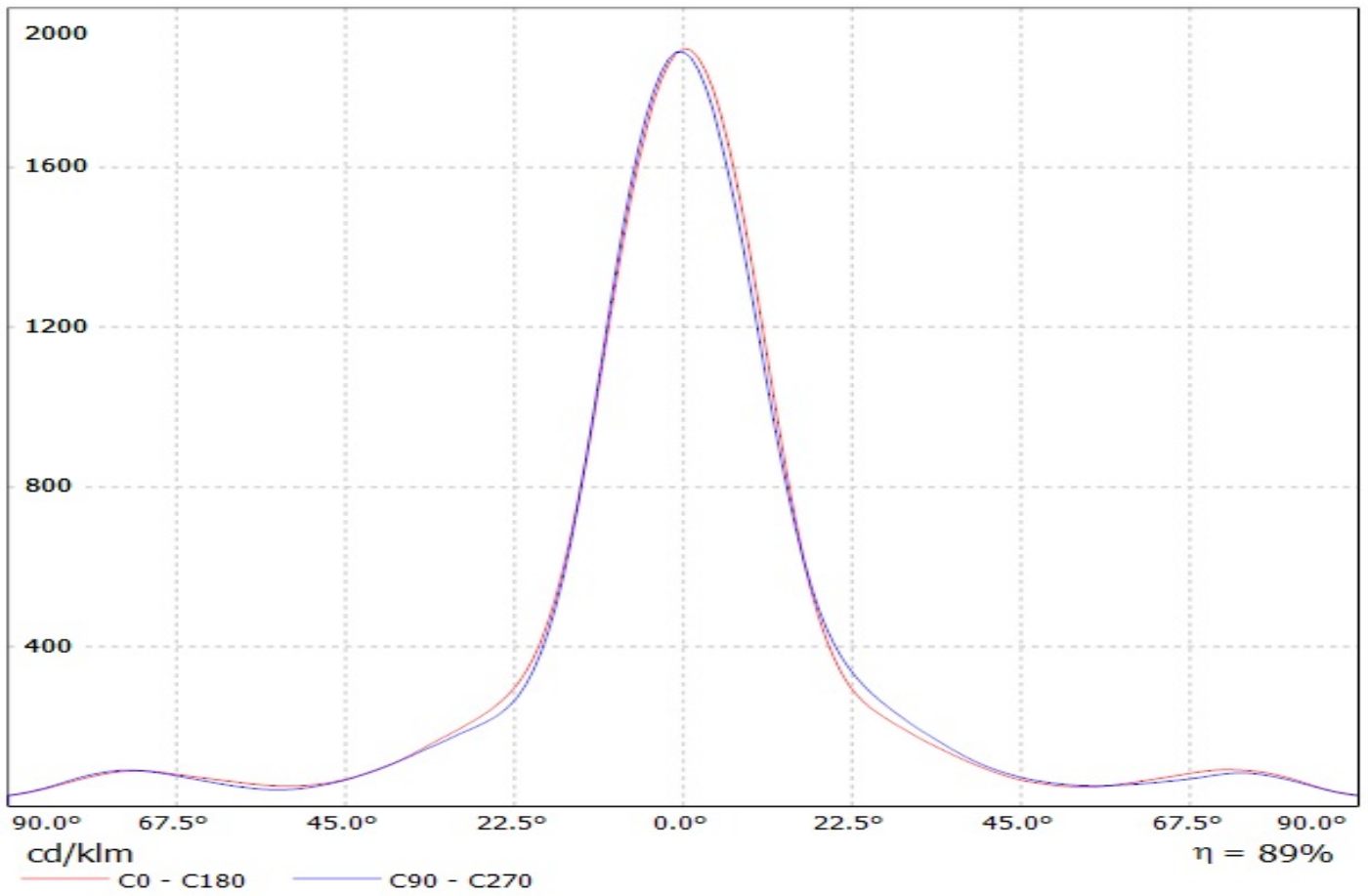

Luminaire: Ledil FN14720\_STELLA-FRESNEL\_(Soleriq\_S19)  
Lamps: 1 x Osram\_Soleriq\_S19\_(GW-KAHJB1.EM)\_1487.02lm@250mA\_P=10.562W\_I=0.25A

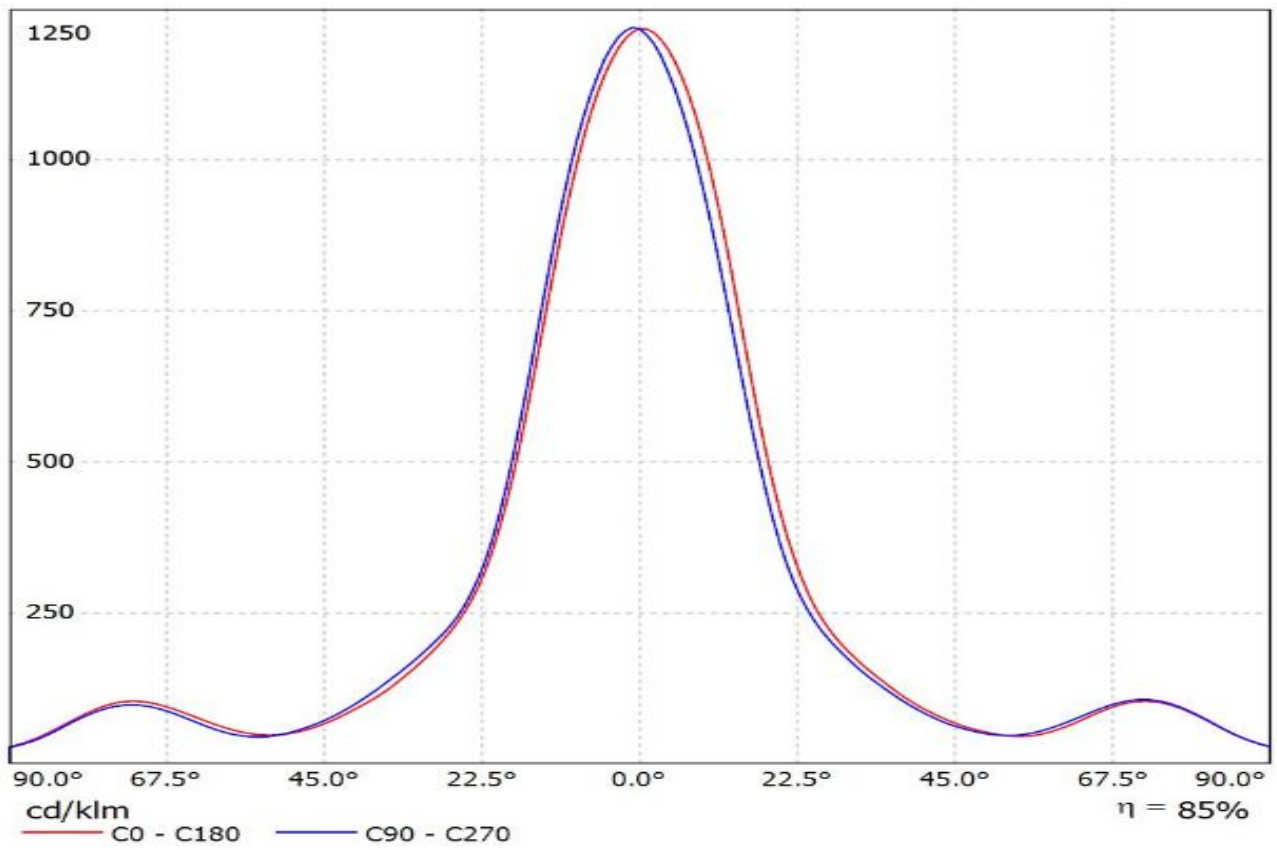

Luminaire: LEDiL Oy FN14720\_STELLA-FRESNEL\_(SLM\_1211\_L19\_G6)

Lamps: 1 x Philips\_Fortimo\_SLM\_1211\_L19\_G6\_Poke-In\_1152.17lm@250mA\_P=8.10051W\_I=0.25A

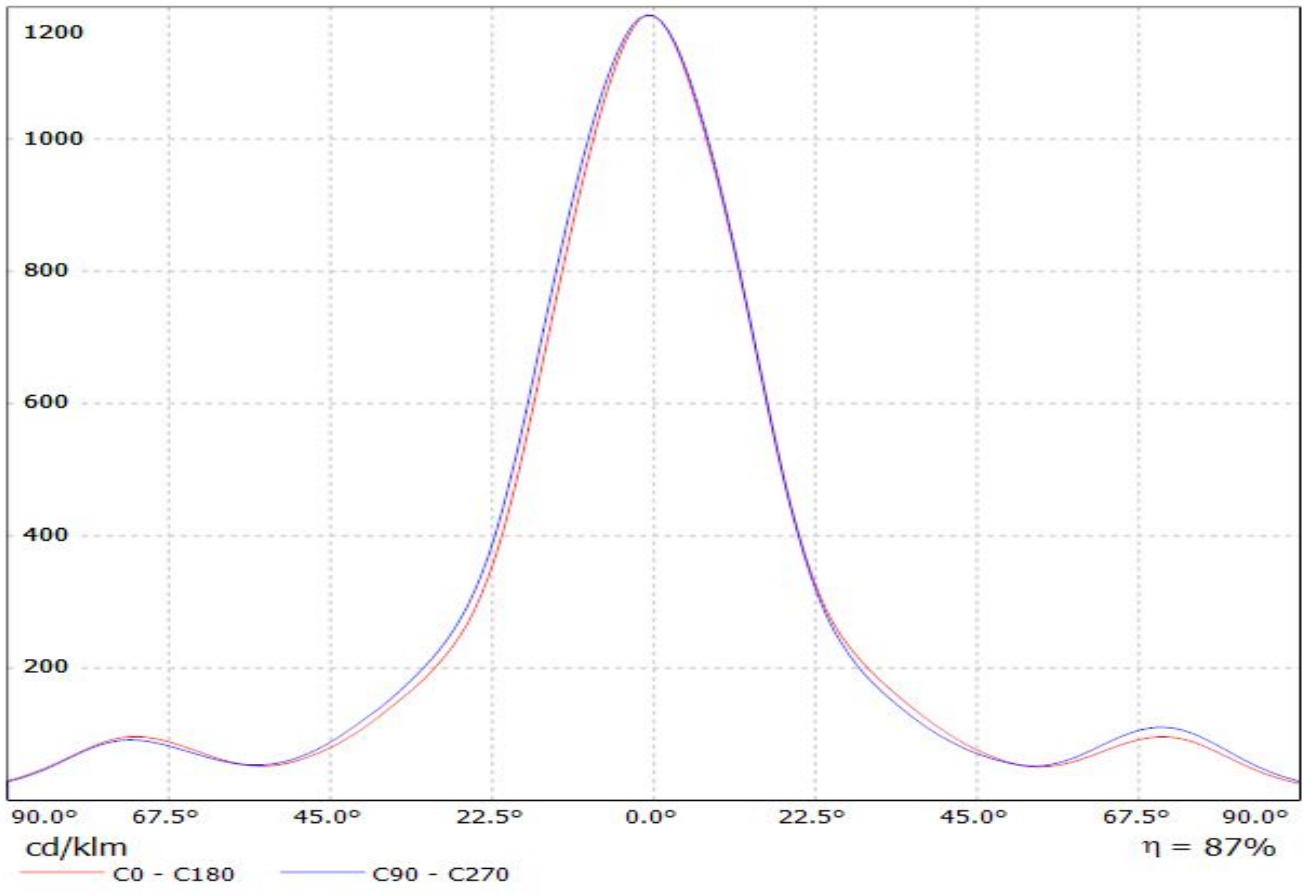

Luminaire: Ledil FN14720\_STELLA-FRESNEL\_(MJT\_80W\_Les22)\_+Ideal\_50-2204CT

Lamps: 1 x Seoul\_MJT\_80W\_Les22mm\_(SAWx22AAA)\_+Ideal\_50-2204CT\_2497.65lm@250mA\_P=13.3118W\_I=0.25A

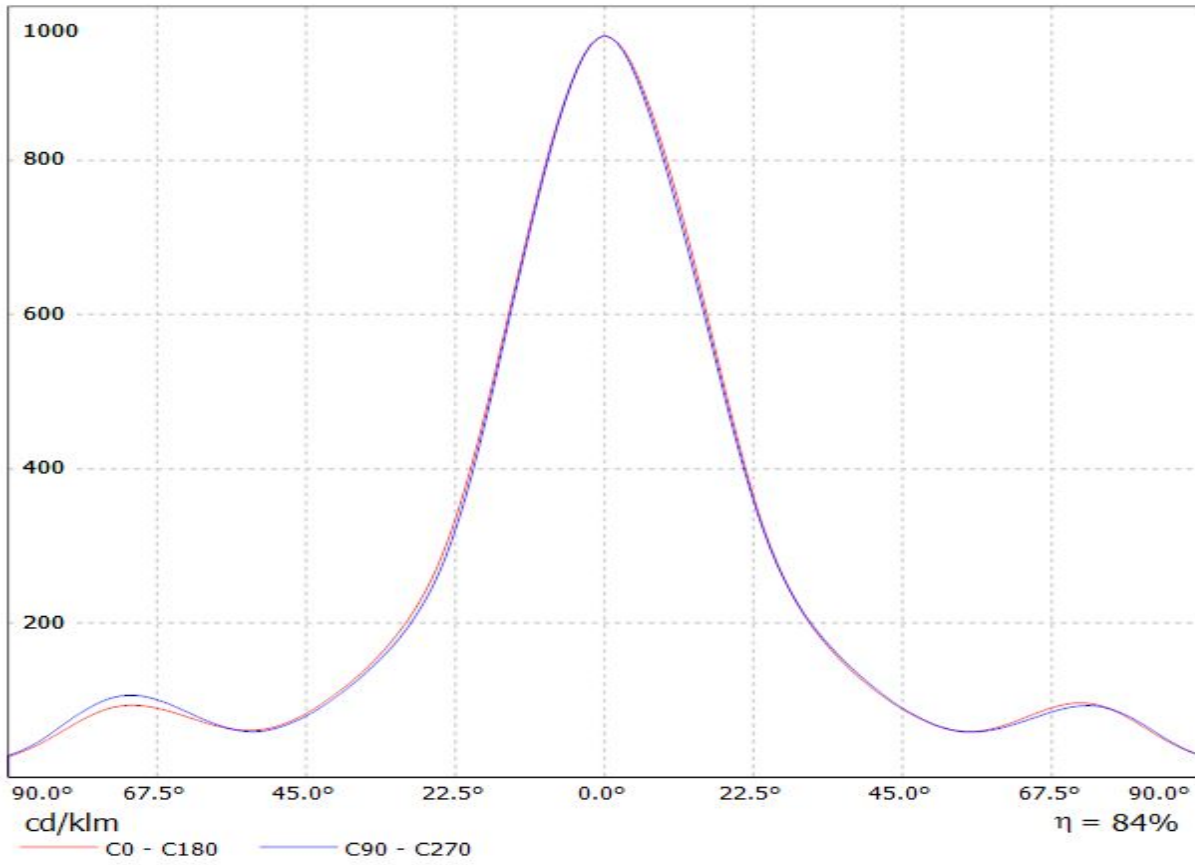

Luminaire: Ledil FN14720\_STELLA-FRESNEL\_(MJT\_30W\_Les14,5)\_+50-2103CT  
Lamps: 1 x Seoul\_MJT\_30W\_Les14,5mm\_(SAWx1566A)\_50-2103CT\_1339.05lm@250mA\_P=8.2275W\_I=0.25A

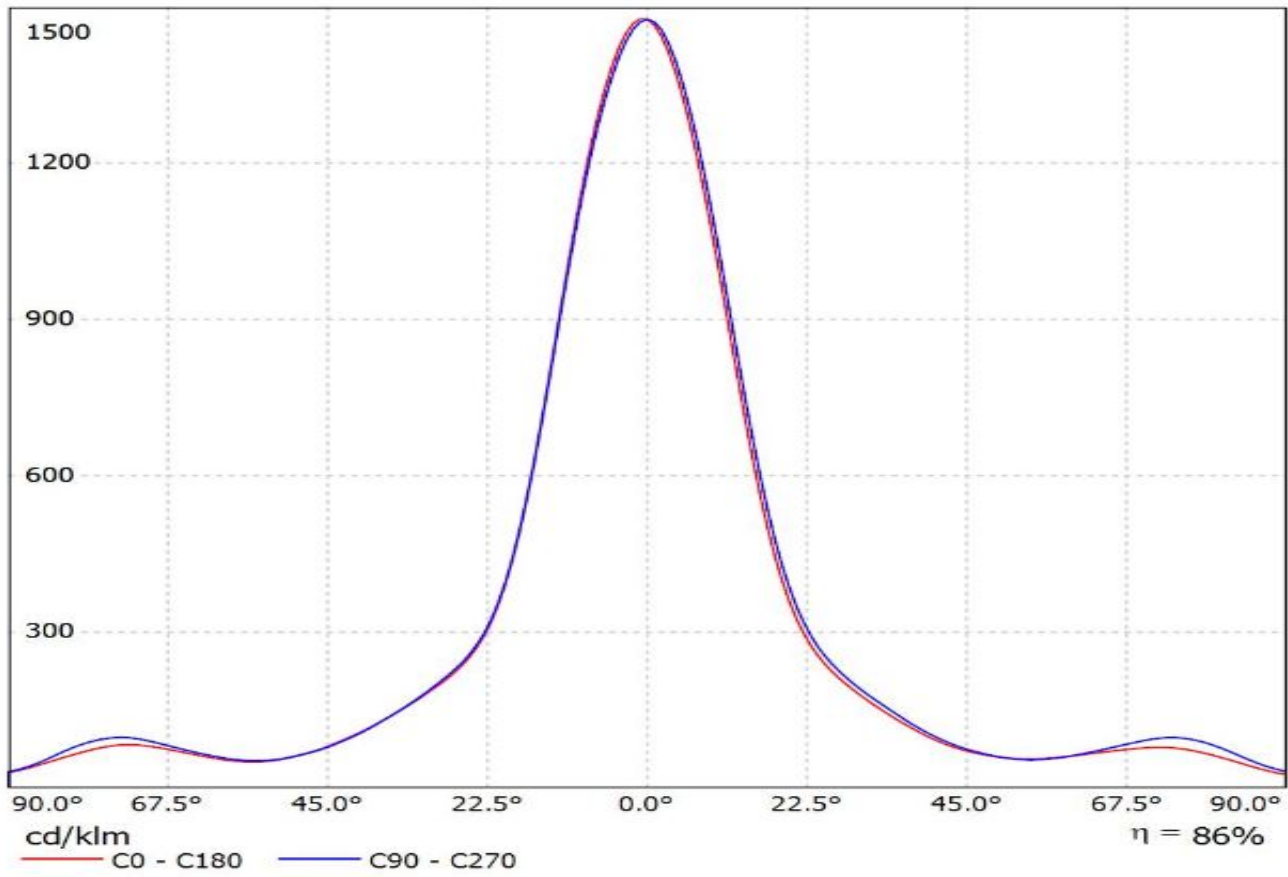

Luminaire: LEDiL Oy FN14720\_STELLA-FRESNEL\_(SLE-G5\_LES-19)  
Lamps: 1 x Tridonic\_SLE-G5\_LES-19\_1189.9lm@250mA\_P=8.3068W\_I=0.250A

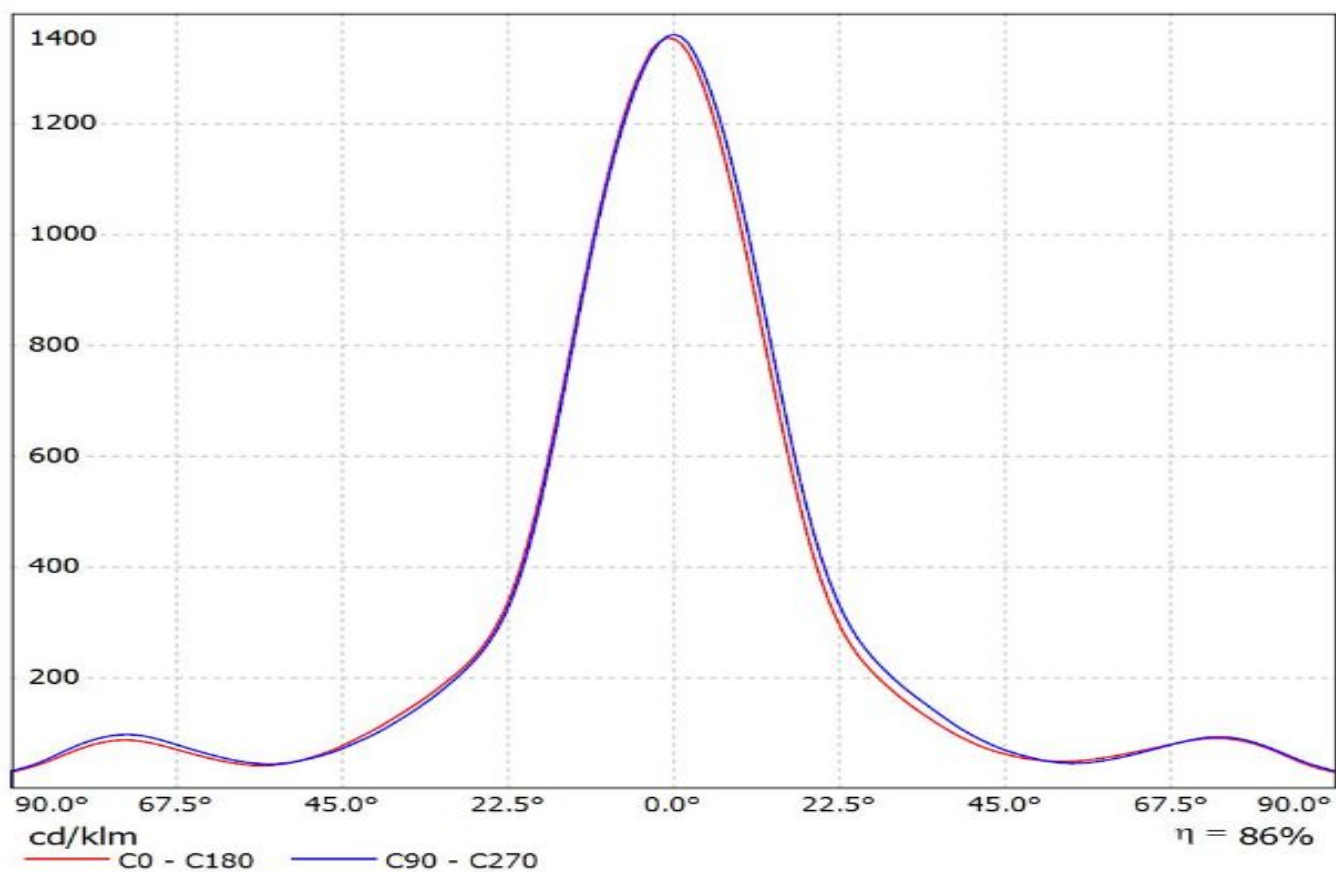



Luminaire: LEDiL Oy FN14720\_STELLA-FRESNEL\_(SLE-G5\_LES-23)  
Lamps: 1 x Tridonic\_SLE-G5\_LES-23\_1408.28lm@250mA\_P=8.1392W\_I=0.250A

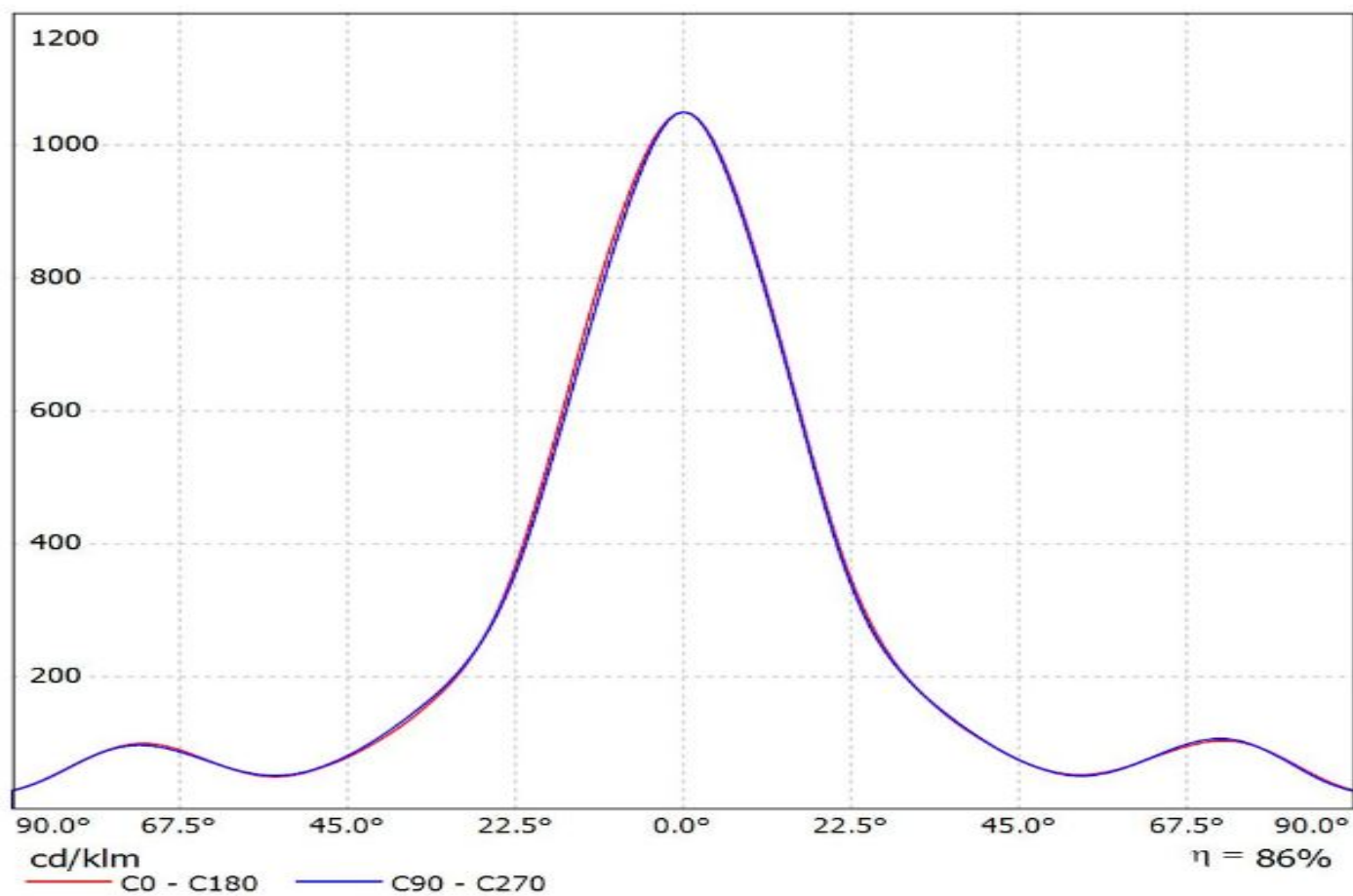

Luminaire: Ledil FN14720\_STELLA-FRESNEL\_(Vero29)

Lamps: 1 x Bridgelux\_Vero29\_(30-E10K0L-Y2)\_1467.5lm@250mA\_P=8.8850W\_I=0.25A

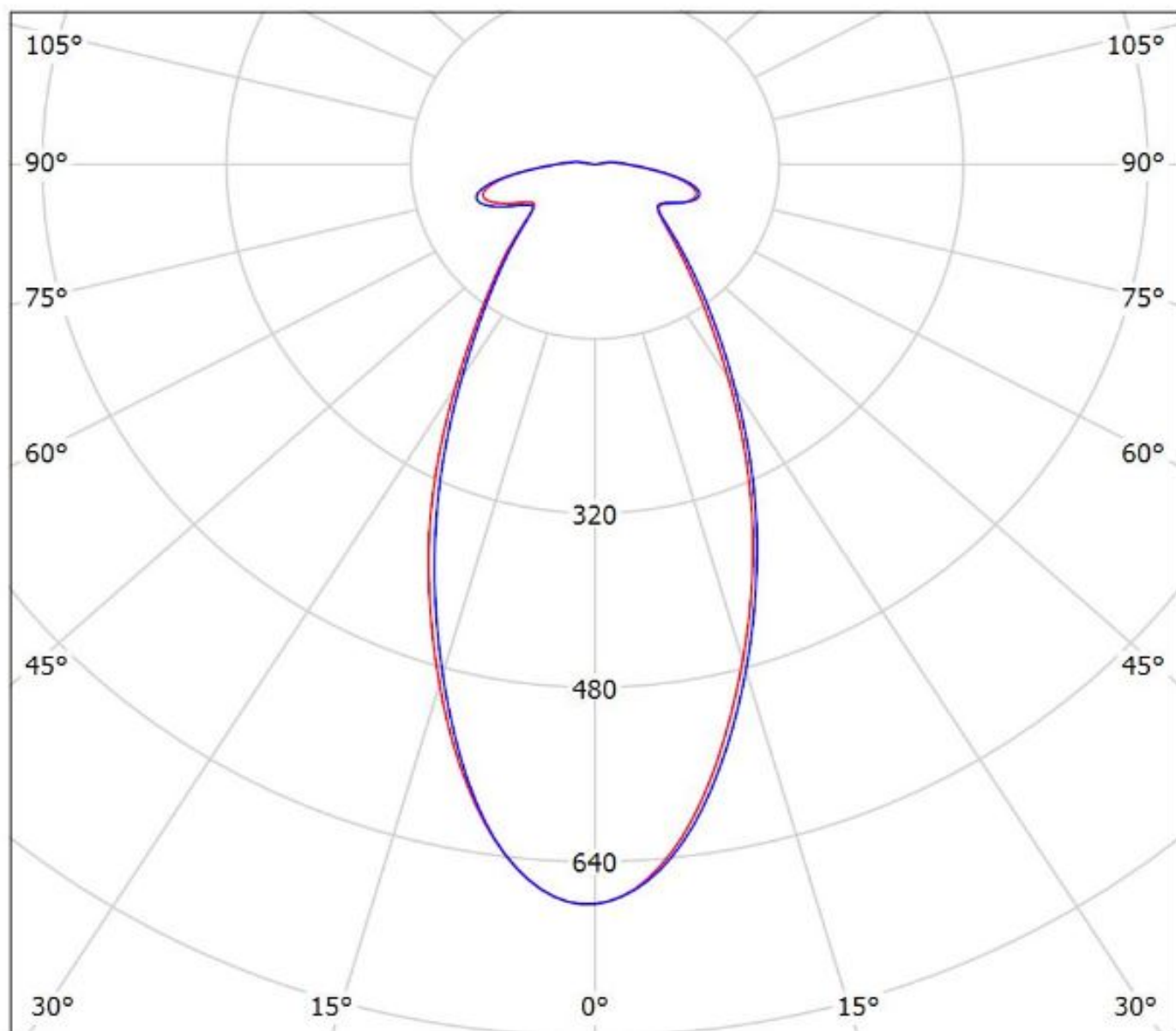

cd/klm

— C0 - C180

— C90 - C270

$\eta = 87\%$

Luminaire: Ledil FN14720\_STELLA-FRESNEL\_(Vero29\_SE\_Gen7)  
Lamps: 1 x Vero29\_SE\_Gen7\_1750.87lm@250mA\_P=8.5765\_I=0.25A

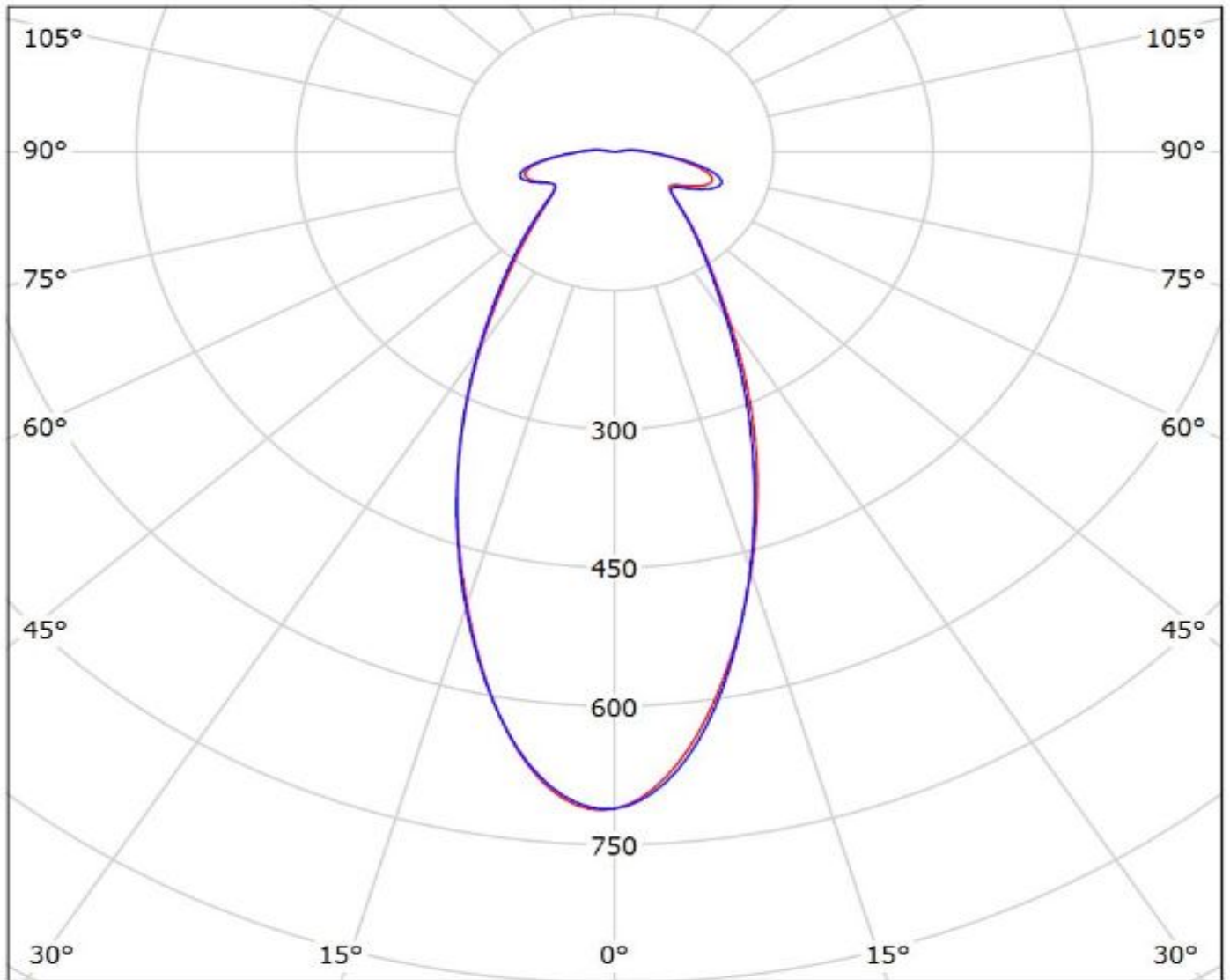

cd/klm

— C0 - C180 — C90 - C270

$\eta = 87\%$

Luminaire: Ledil FN14720\_STELLA-FRESNEL\_Vero\_13\_SE)  
Lamps: 1 x Bridgelux\_Vero\_13\_SE\_(BXRC-30E2000-C-73-SE)  
\_1310.97lm@250mA\_CCT=3000K\_P=8.17575W\_I=0.25A

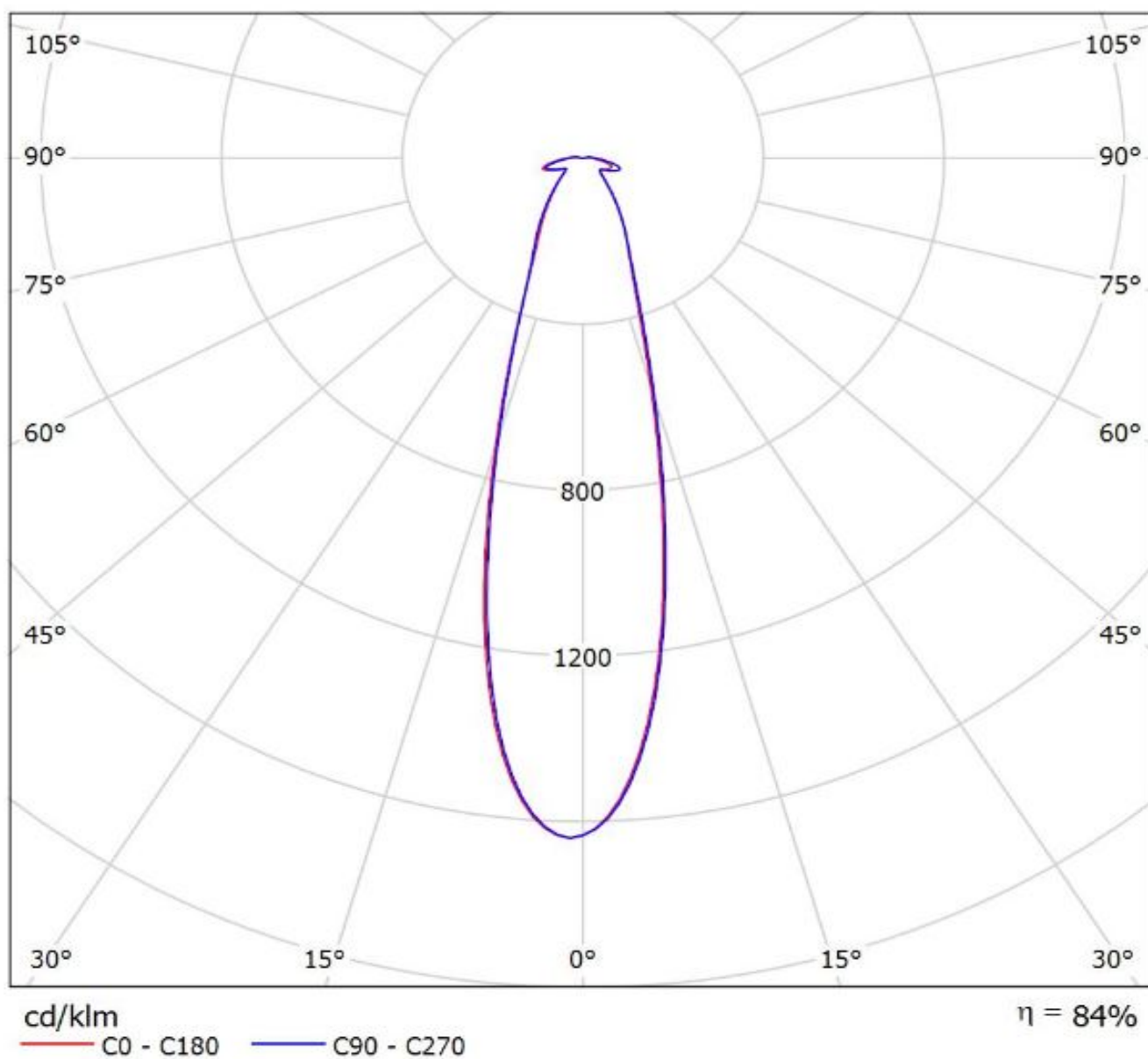

Luminaire: LEDiL Oy FN14720\_STELLA-FRESNEL\_(VERO18\_SE)  
Lamps: 1 x Bridgelux\_VERO18\_SE\_(BXRC-30E4000-C-73-SE)  
\_1335.46lm@250mA\_P=7.9961W\_I=0.25A

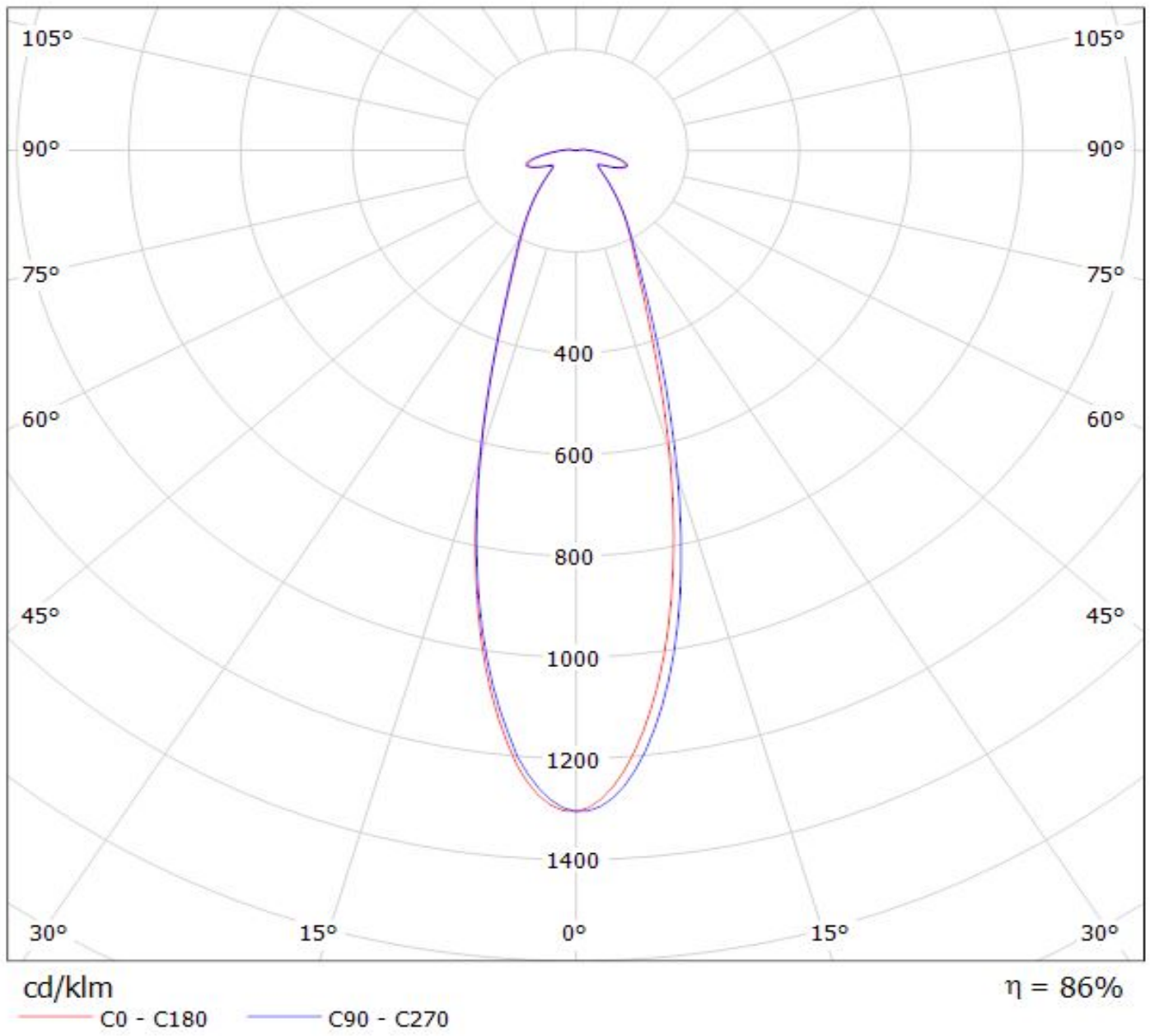

Luminaire: Ledil Oy FN14720\_STELLA-FRESNEL+\_Bender+Wirth 434 TypL1\_BRIDGELUX\_V10\_Gen7\_SIMULATED  
Lamps: 1 x BRIDGELUX V10 Gen7

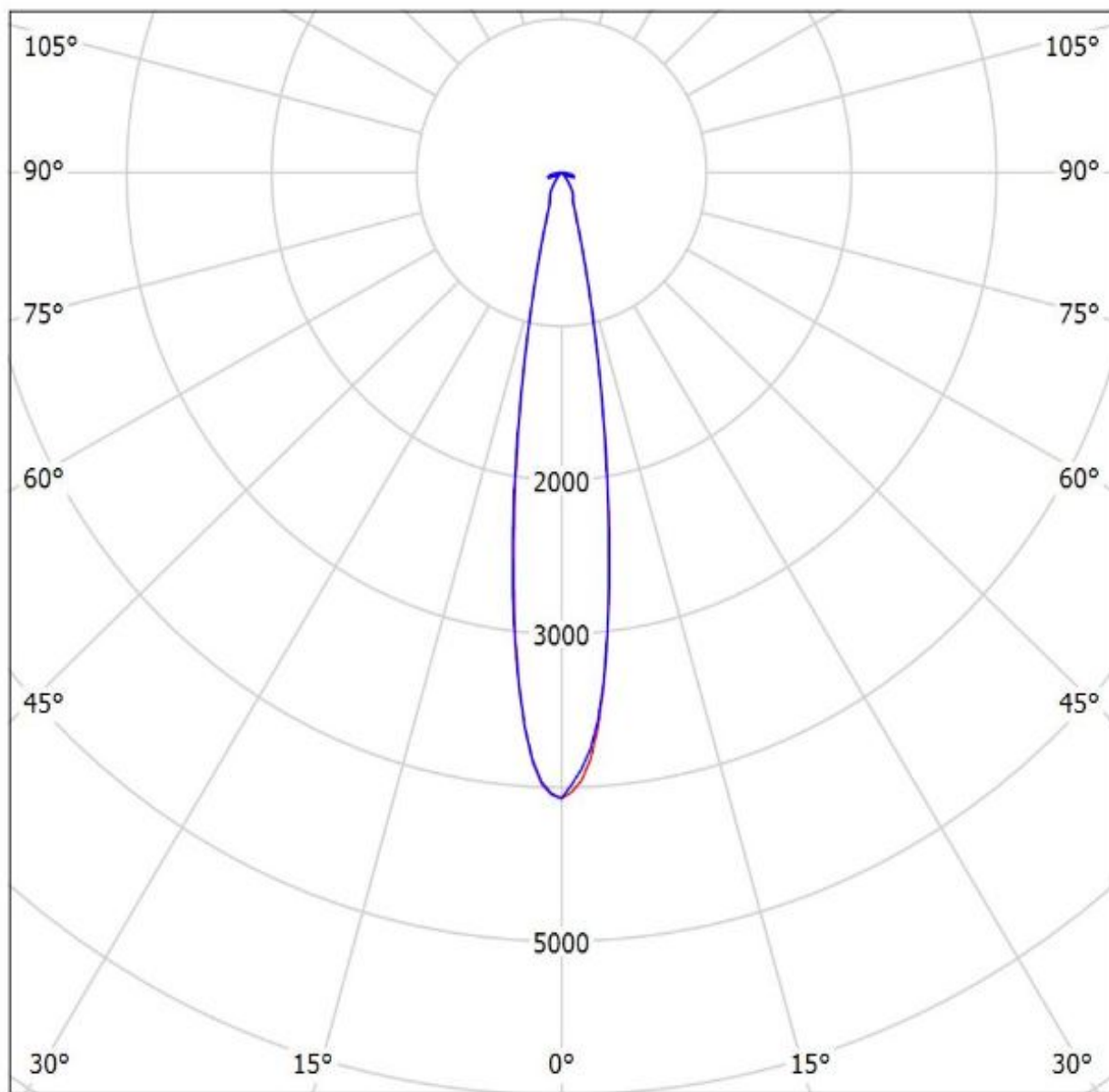

cd/klm

— C0 - C180 — C90 - C270

$\eta = 85\%$

Luminaire: Ledil Oy FN14720\_STELLA-FRESNEL\_Bridgelux\_V22\_Gen7\_SIMULATED FN14720\_STELLA-FRESNEL\_Bridgelux\_V22\_Gen7\_SIMULATED  
Lamps: 1 x FN14720\_STELLA-FRESNEL\_Bridgelux\_V22\_Gen7\_SIMULATED

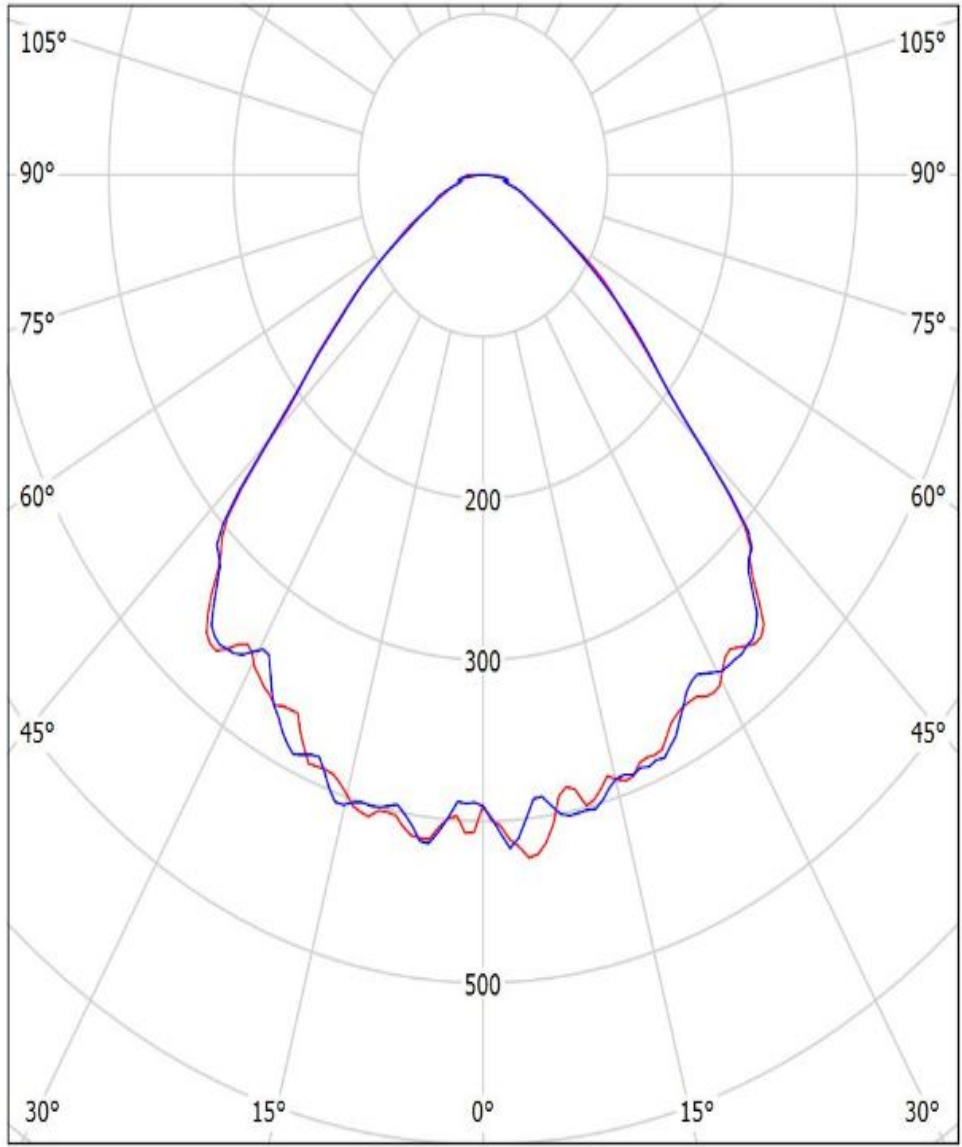

cd/klm  
— C0 - C180 — C90 - C270

$\eta = 94\%$

Luminaire: Ledil Oy FN14720\_STELLA-FRESNEL\_+\_BJB\_47\_319\_2350\_BRIDGELUX\_V18\_Gen7\_SIMULATED  
Lamps: 1 x BRIDGELUX V18 Gen7

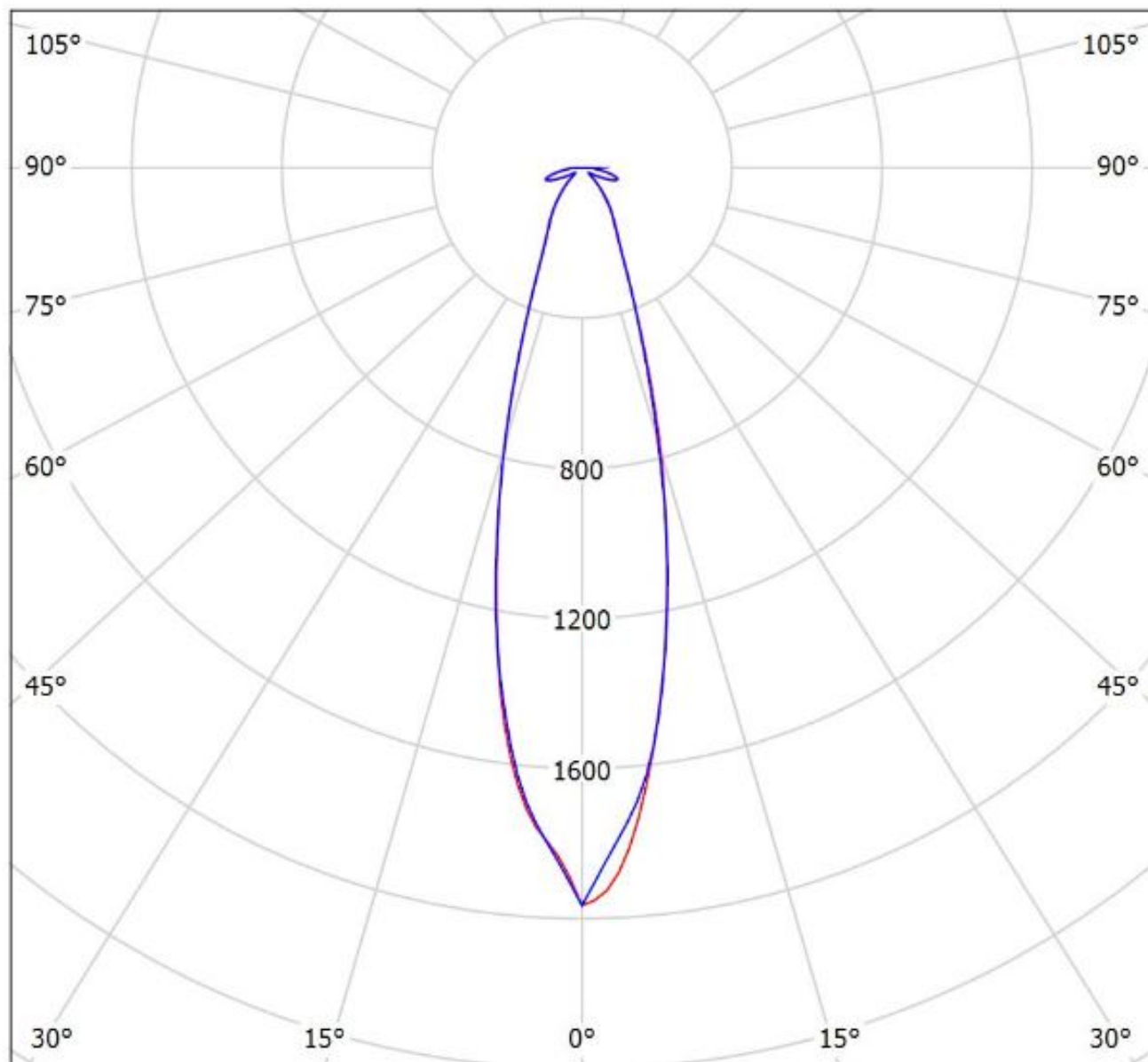

cd/klm

— C0 - C180 — C90 - C270

$\eta = 85\%$



Luminaire: LEDiL Oy FN14720-STELLA-FRESNEL\_(V22\_Gen7+BW)  
Lamps: 1 x Bridgelux\_V22\_Gen7\_(BXRE-30E6500-B)  
+BW431\_TypZ1\_2036.72lm@250mA\_P=11.891W\_I=0.250A

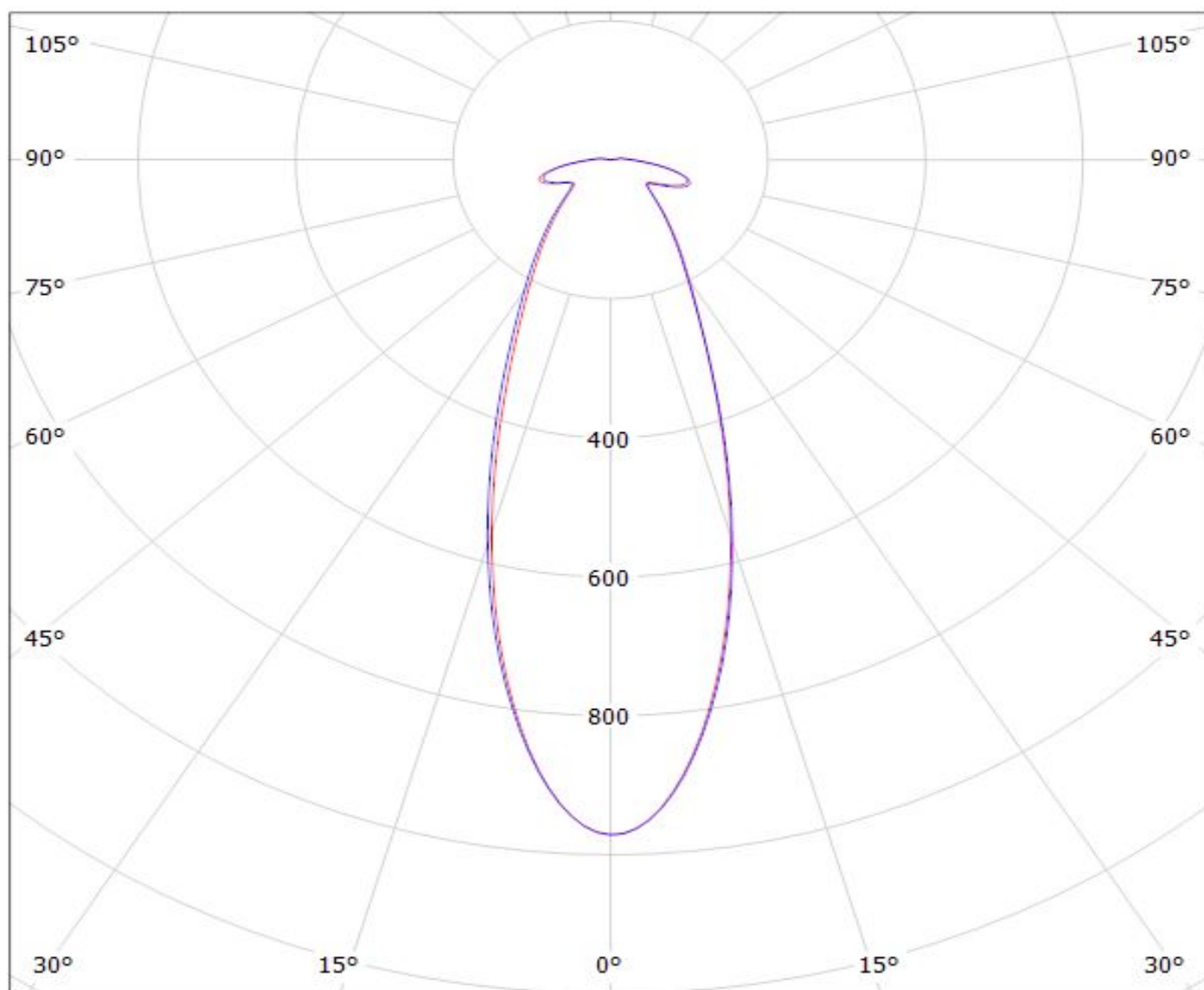

cd/klm

— C0 - C180

— C90 - C270

$\eta = 84\%$

Luminaire: LEDiL Oy FN14720\_STELLA-FRESNEL\_(CLU046)

Lamps: 1 x Citizen\_CLU046\_1354.66lm@250mA\_P=8.06877W\_I=0.2499A

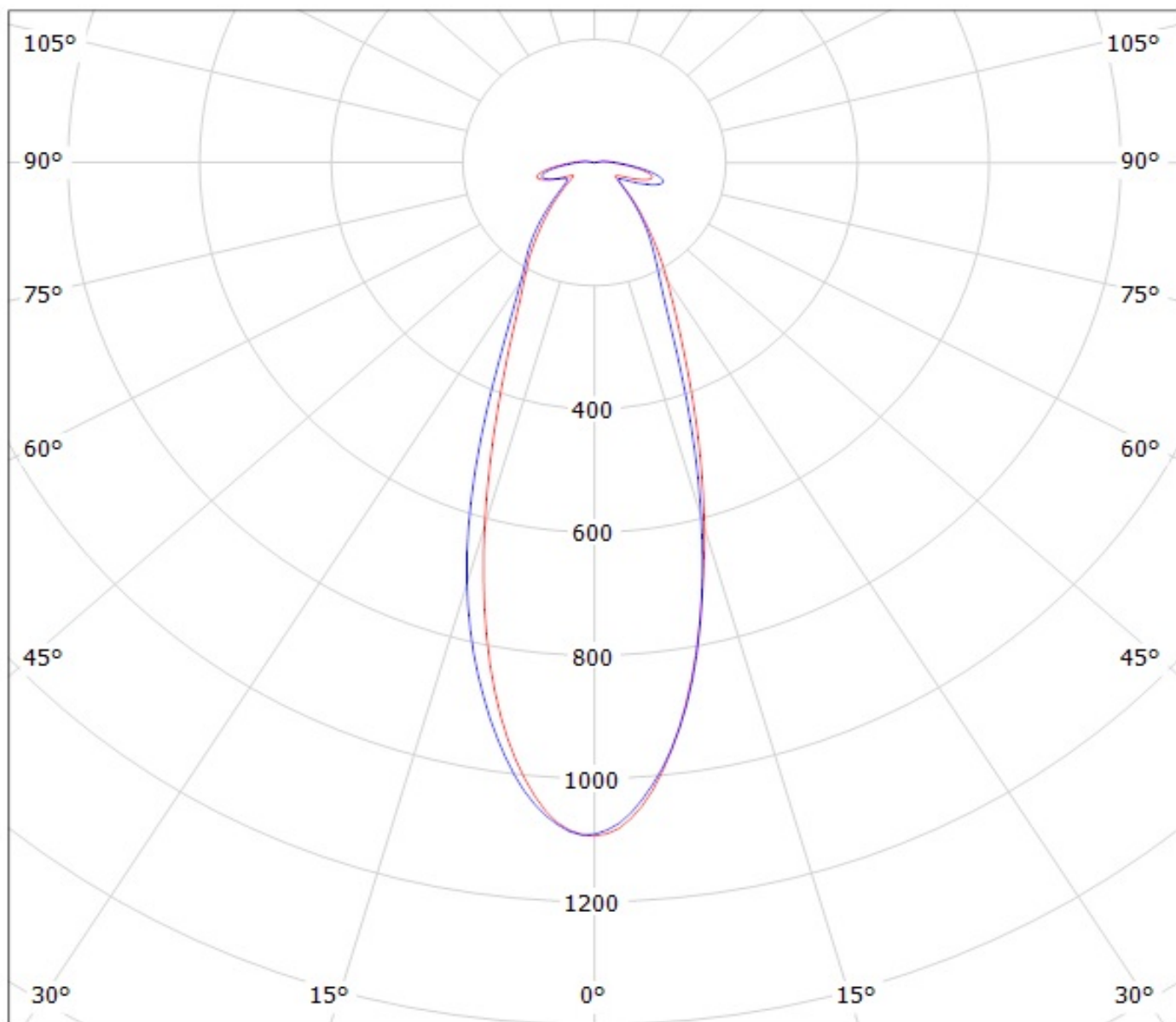

cd/klm

— C0 - C180

— C90 - C270

$\eta = 86\%$

Luminaire: Ledil Oy FN14720\_STELLA-FRESNEL\_(CITIZEN\_CLU05x)\_SIMULATED  
Lamps: 1 x CITIZEN\_CLU054

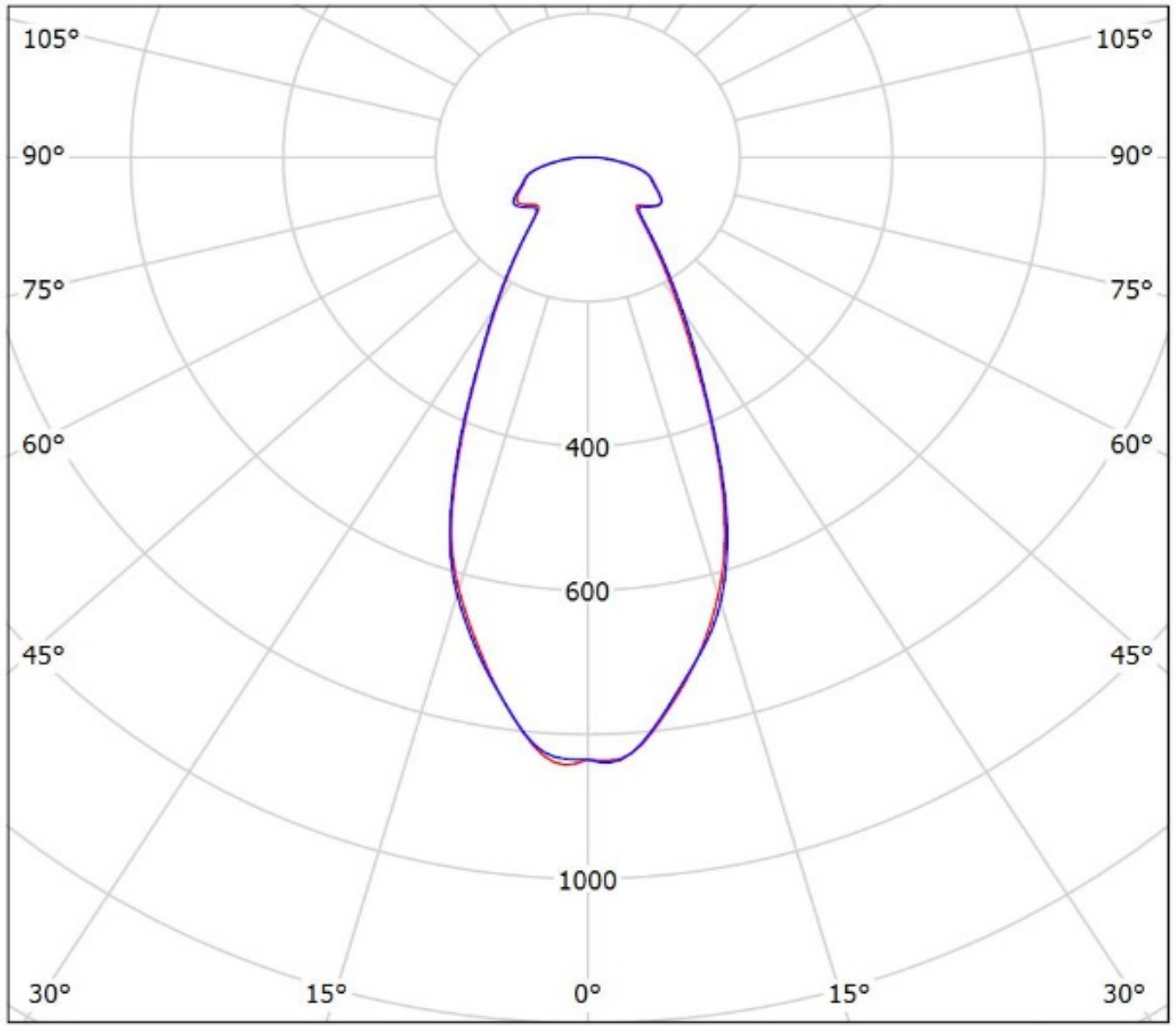

cd/klm

— C0 - C180 — C90 - C270

$\eta = 91\%$

Luminaire: Ledil Oy FN14720\_STELLA-FRESNEL\_(CXA3590)\_SIMULATED  
Lamps: 1 x Cree CXA3590

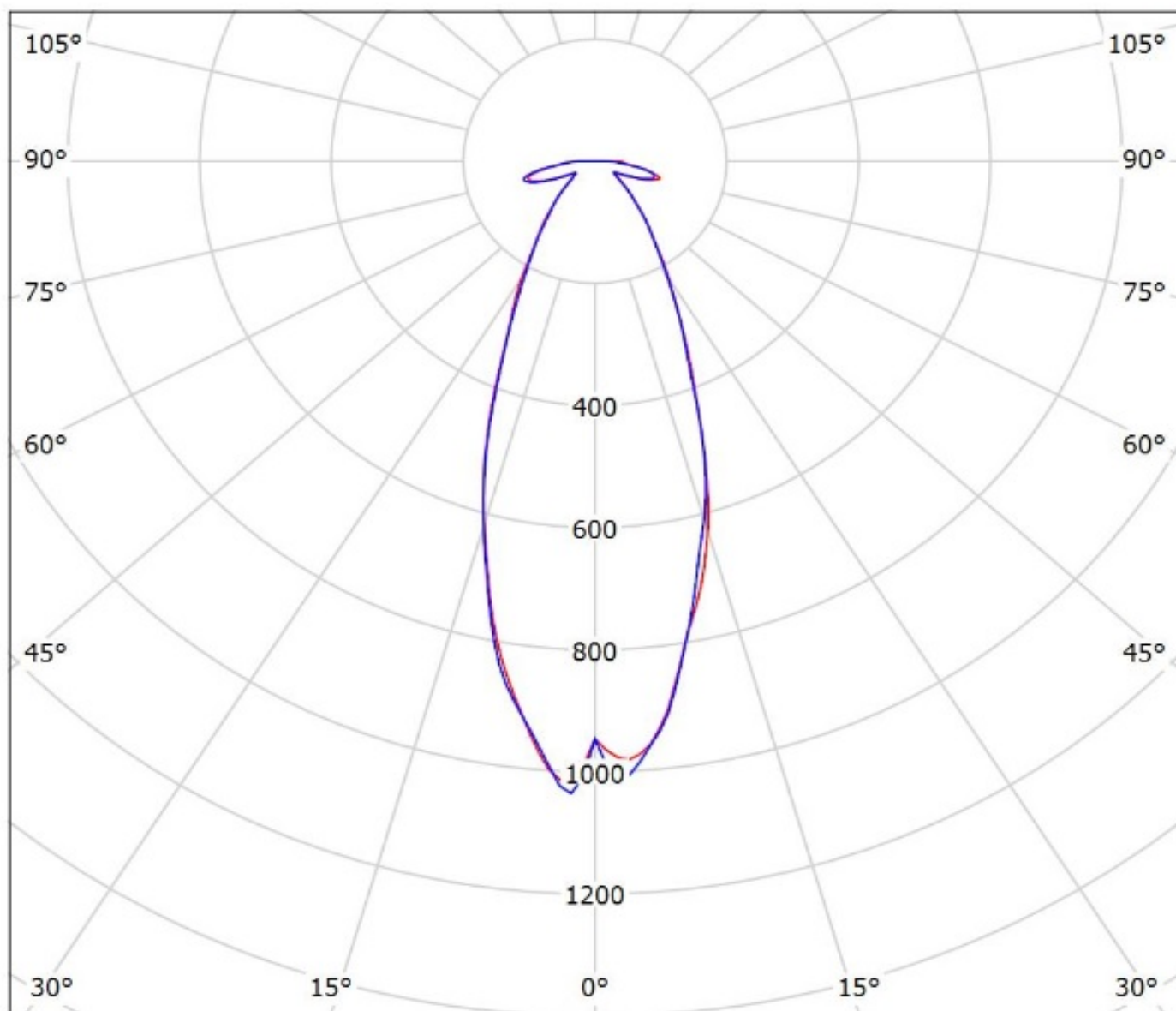

cd/klm

— C0 - C180 — C90 - C270

$\eta = 83\%$

Luminaire: Ledil Oy FN14720\_STELLA-FRESNEL\_(CXA2590)\_SIMULATED  
Lamps: 1 x Cree CXA2590

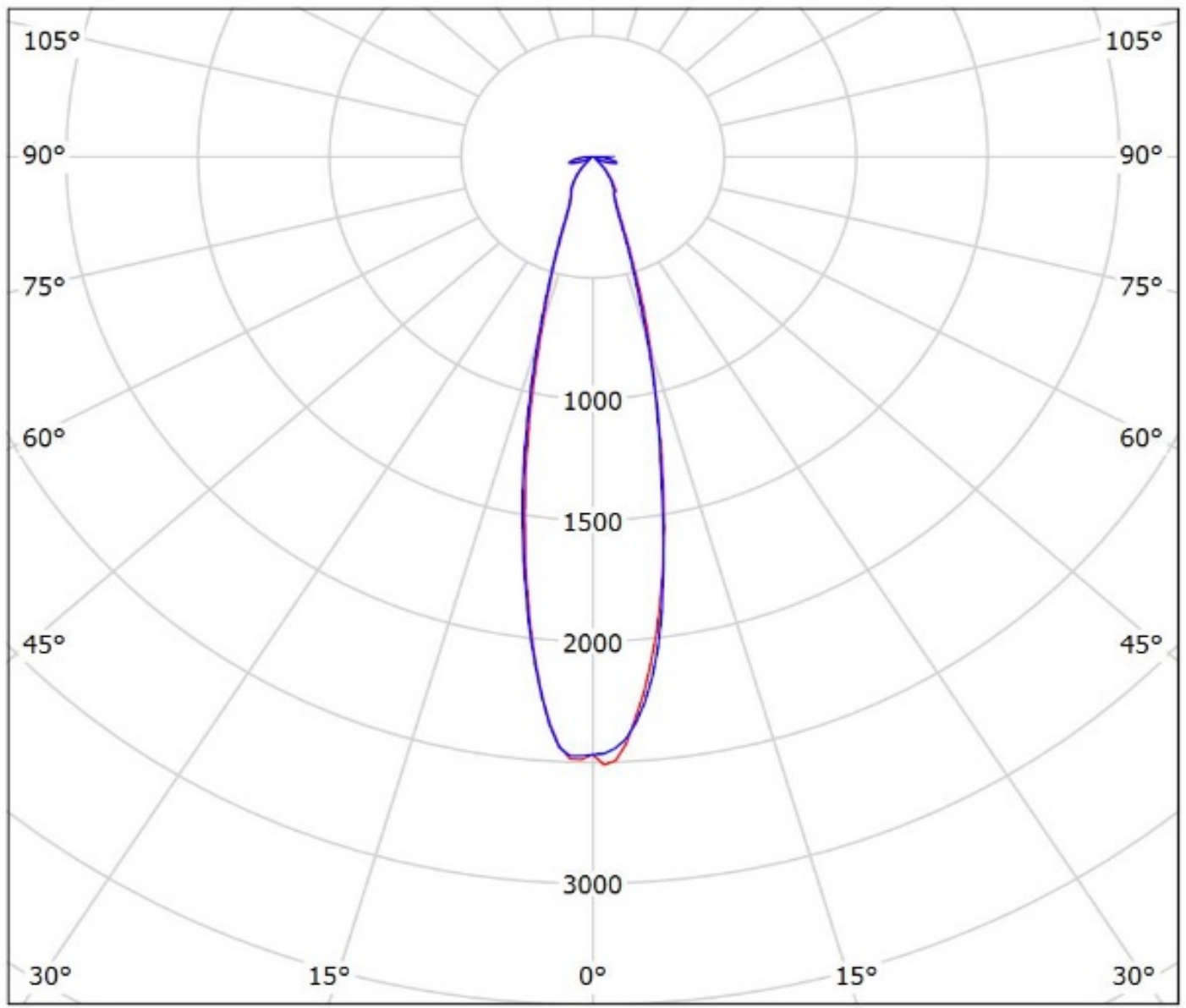

cd/klm

— C0 - C180    — C90 - C270

$\eta = 83\%$

Luminaire: Ledil FN14720\_STELLA-FRESNEL\_(CXB3070\_+BJB)

Lamps: 1 x Cree\_CXB3070\_(-30G-AD-N0H-0001)\_+BJB\_47.319.2150\_1399.52lm@250mA\_CCT=3000K\_P=8.0355W\_I=0.25A

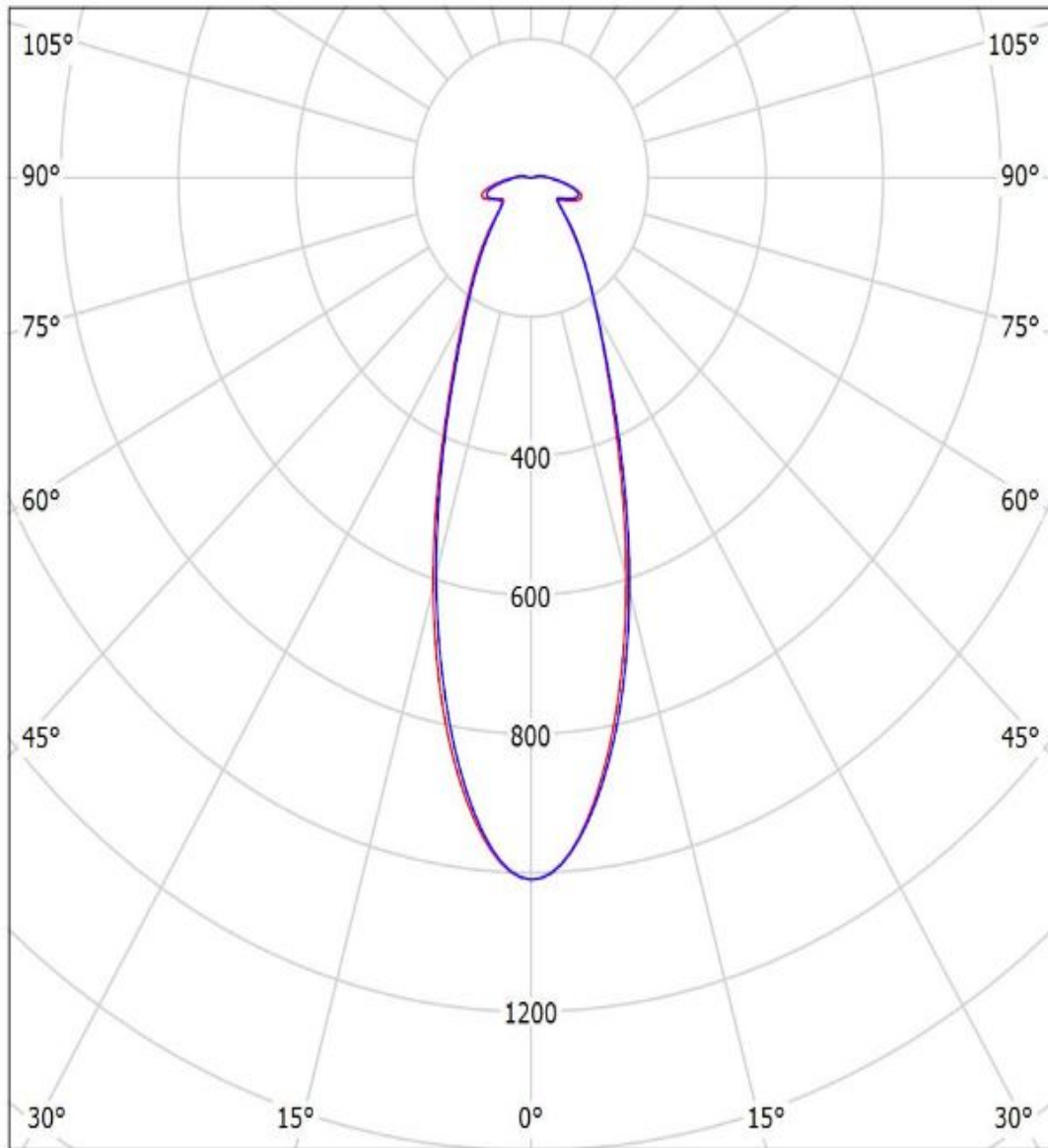

cd/klm

— C0 - C180 — C90 - C270

$\eta = 88\%$

Luminaire: Ledil FN14720\_STELLA-FRESNEL\_(CoB\_1216)

Lamps: 1 x Luxeon\_CoB\_1216\_(L2C2-40801216E2300)\_1468.12lm@250mA\_P=7.9868W\_I=0.25A

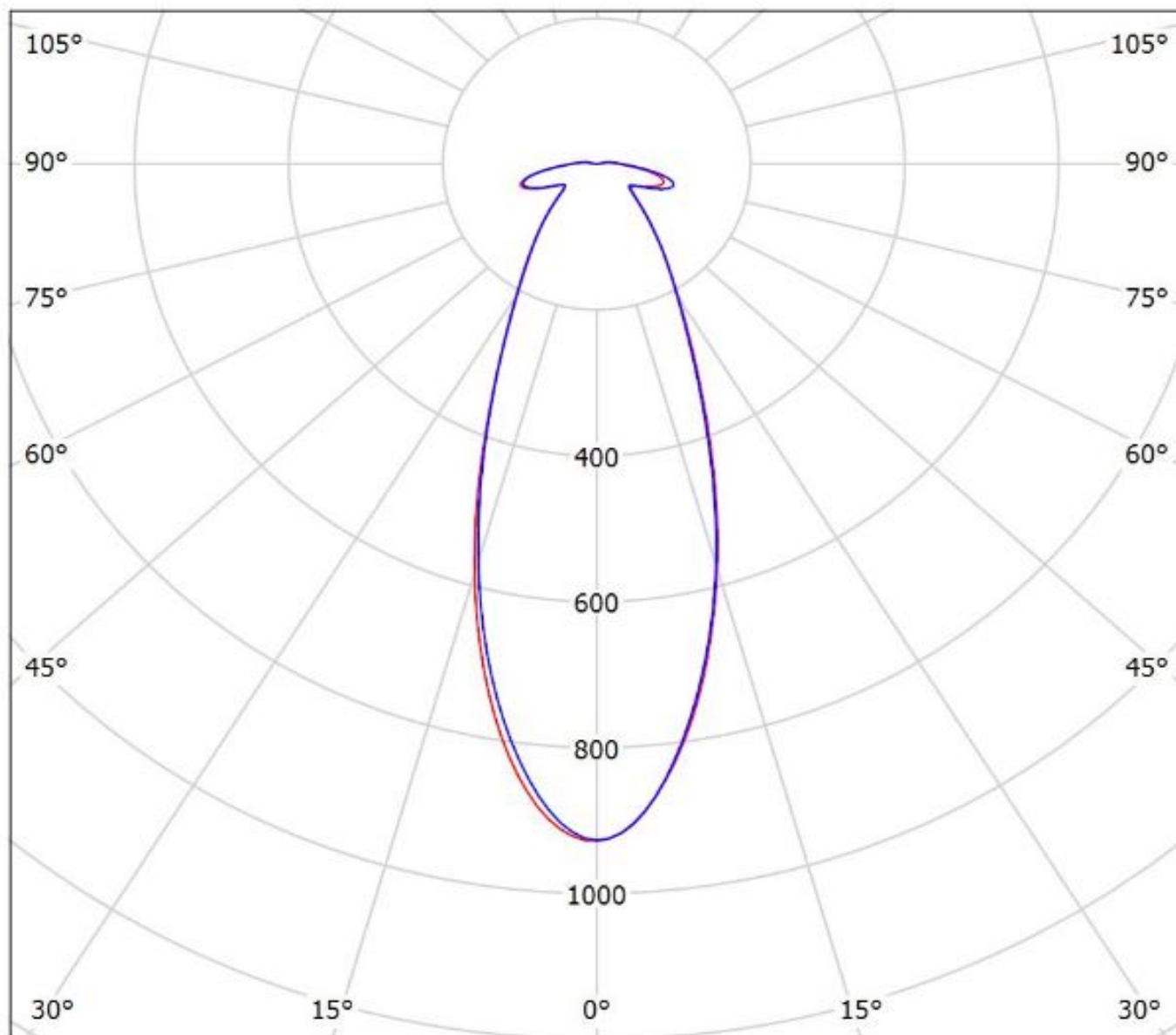

cd/klm

— C0 - C180 — C90 - C270

$\eta = 86\%$

Luminaire: Ledil Oy FN14720\_STELLA-FRESNEL\_(Luxeon\_CoB\_1208)\_SIMULATED  
Lamps: 1 x Lumileds Luxeon CoB 1208

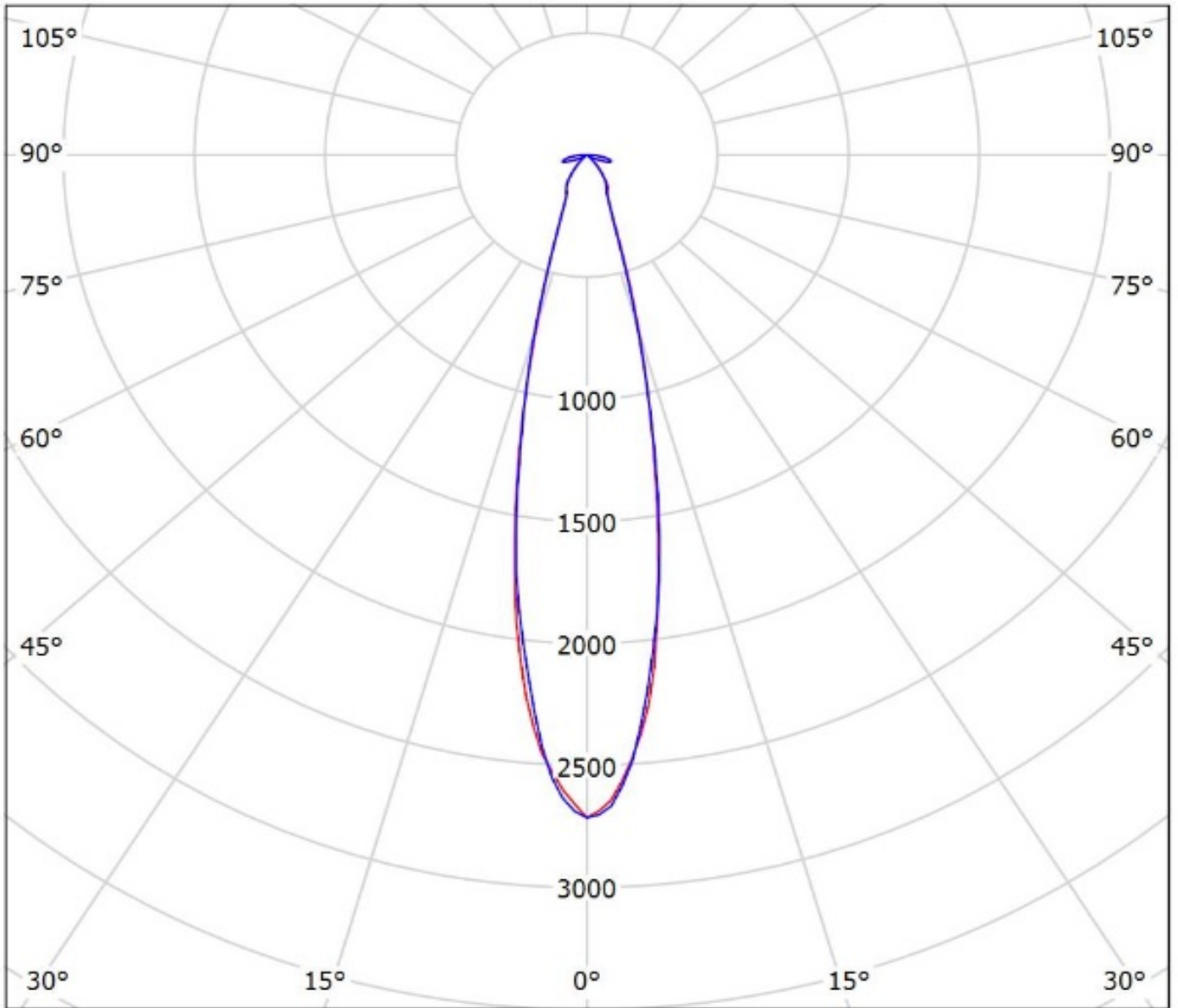

cd/klm

— C0 - C180 — C90 - C270

$\eta = 82\%$



Luminaire: Ledil FN14720\_STELLA-FRESNEL\_(CXM-22\_+BW)

Lamps: 1 x LUMINUS\_CXM-

22\_+Bender&Wirth\_431TypL3\_1259.61lm@250mA\_P=8.0332W\_CCT=3000K\_I=0.25A

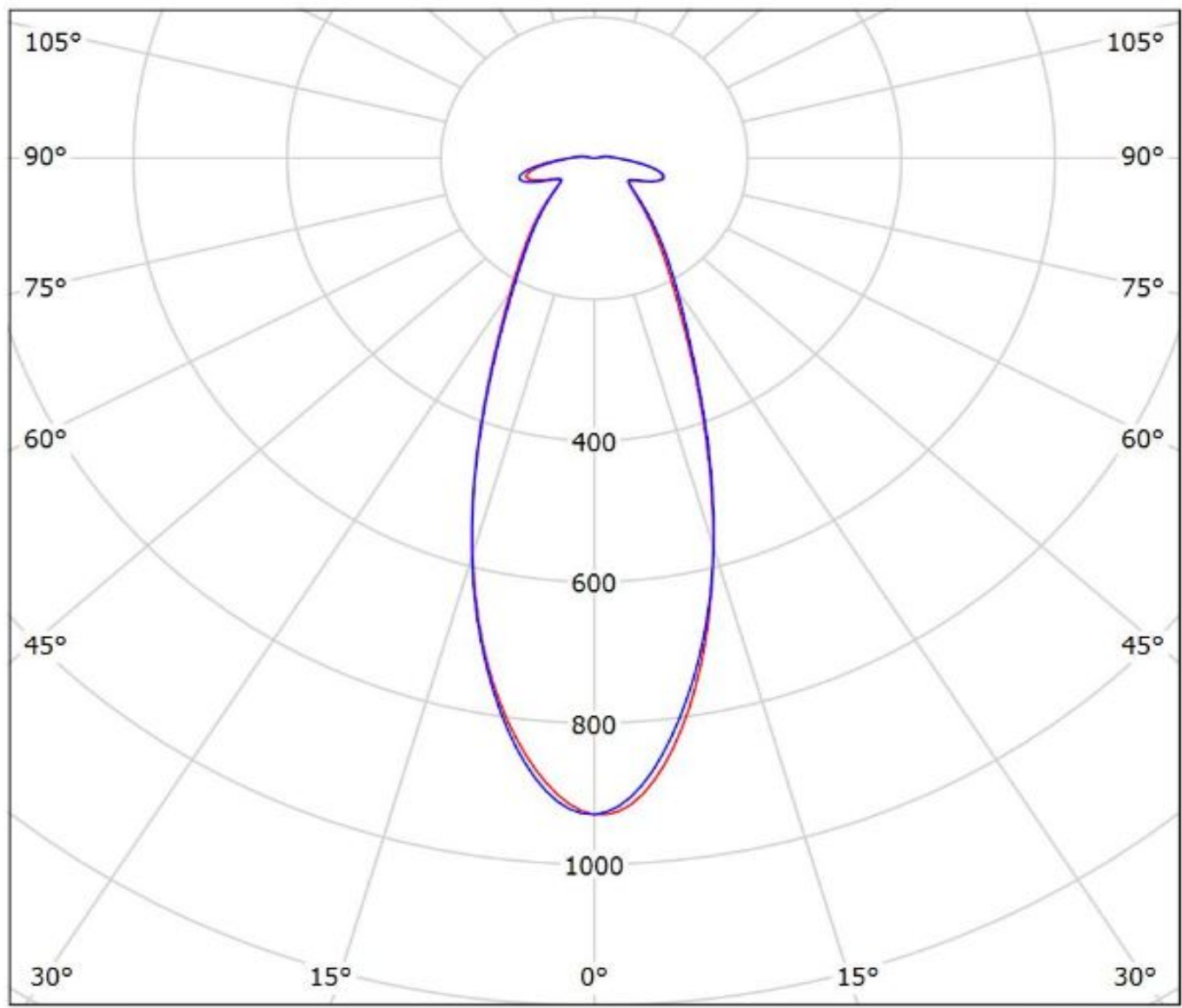

cd/klm

— C0 - C180

— C90 - C270

$\eta = 86\%$

Luminaire: LEDiL Oy FN14720\_STELLA-FRESNEL\_(Soleriq\_P13)\_Cav1

Lamps: 1 x Osram\_Soleriq\_P13\_(GQ\_MAGMB1.EM)\_922.464lm@250mA\_P=8.69804W\_I=0.2498A

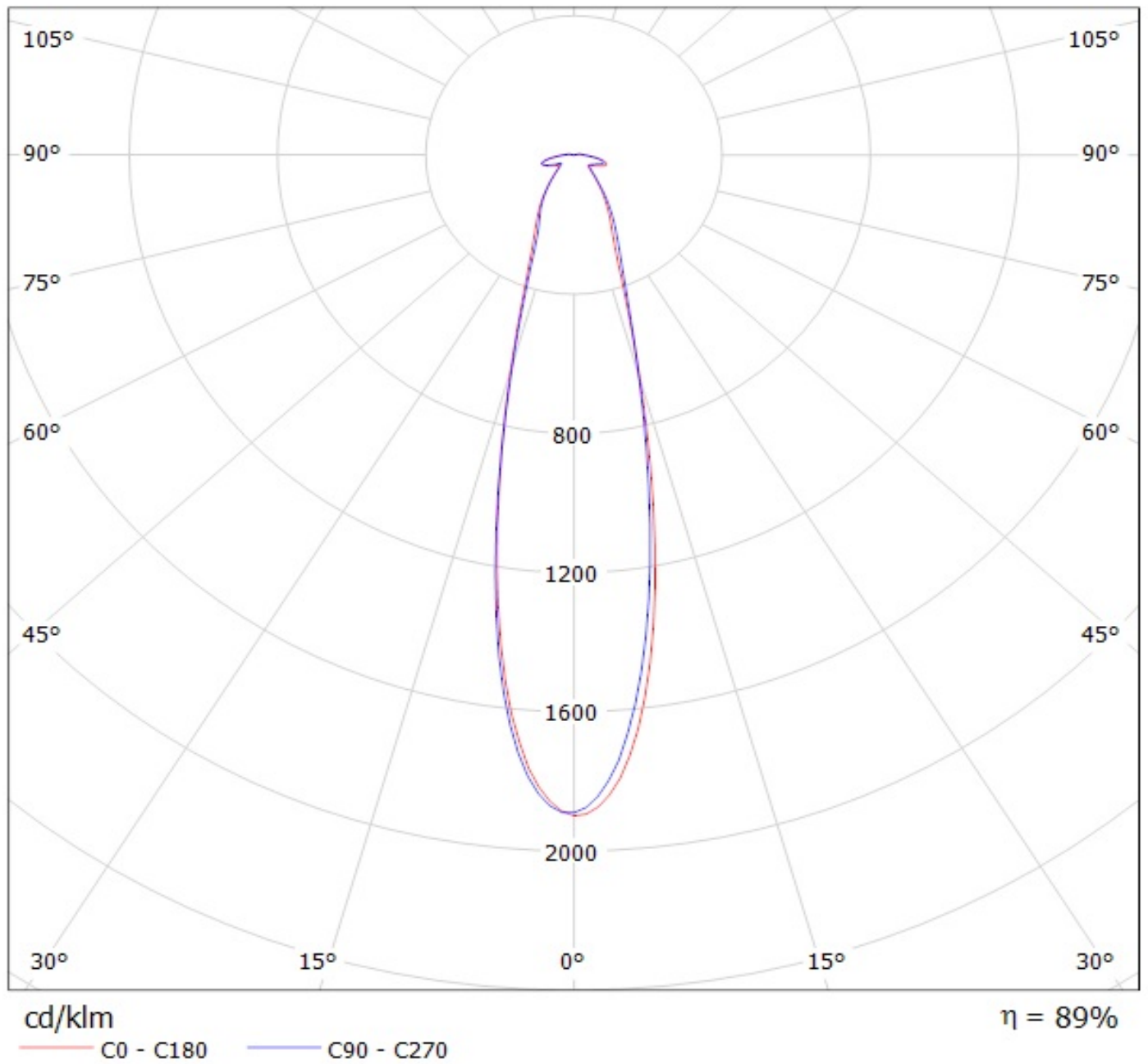

Luminaire: Ledil FN14720\_STELLA-FRESNEL\_(Soleriq\_S19)

Lamps: 1 x Osram\_Soleriq\_S19\_(GW-KAHJB1.EM)\_1487.02lm@250mA\_P=10.562W\_I=0.25A

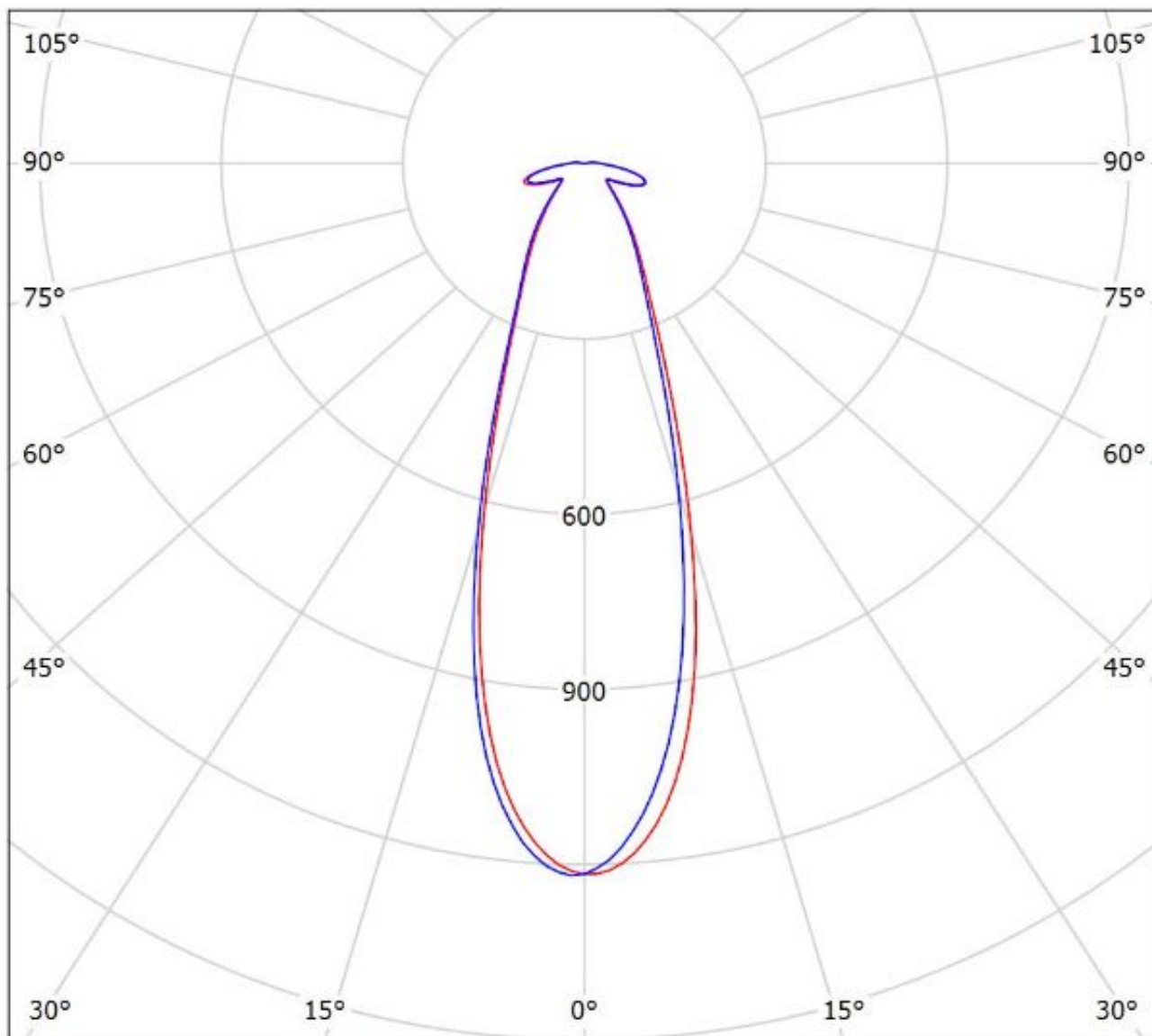

cd/klm

— C0 - C180 — C90 - C270

$\eta = 85\%$

Luminaire: LEDiL Oy FN14720\_STELLA-FRESNEL\_(SLM\_1211\_L19\_G6)

Lamps: 1 x Philips\_Fortimo\_SLM\_1211\_L19\_G6\_Poke-In\_1152.17lm@250mA\_P=8.10051W\_I=0.25A

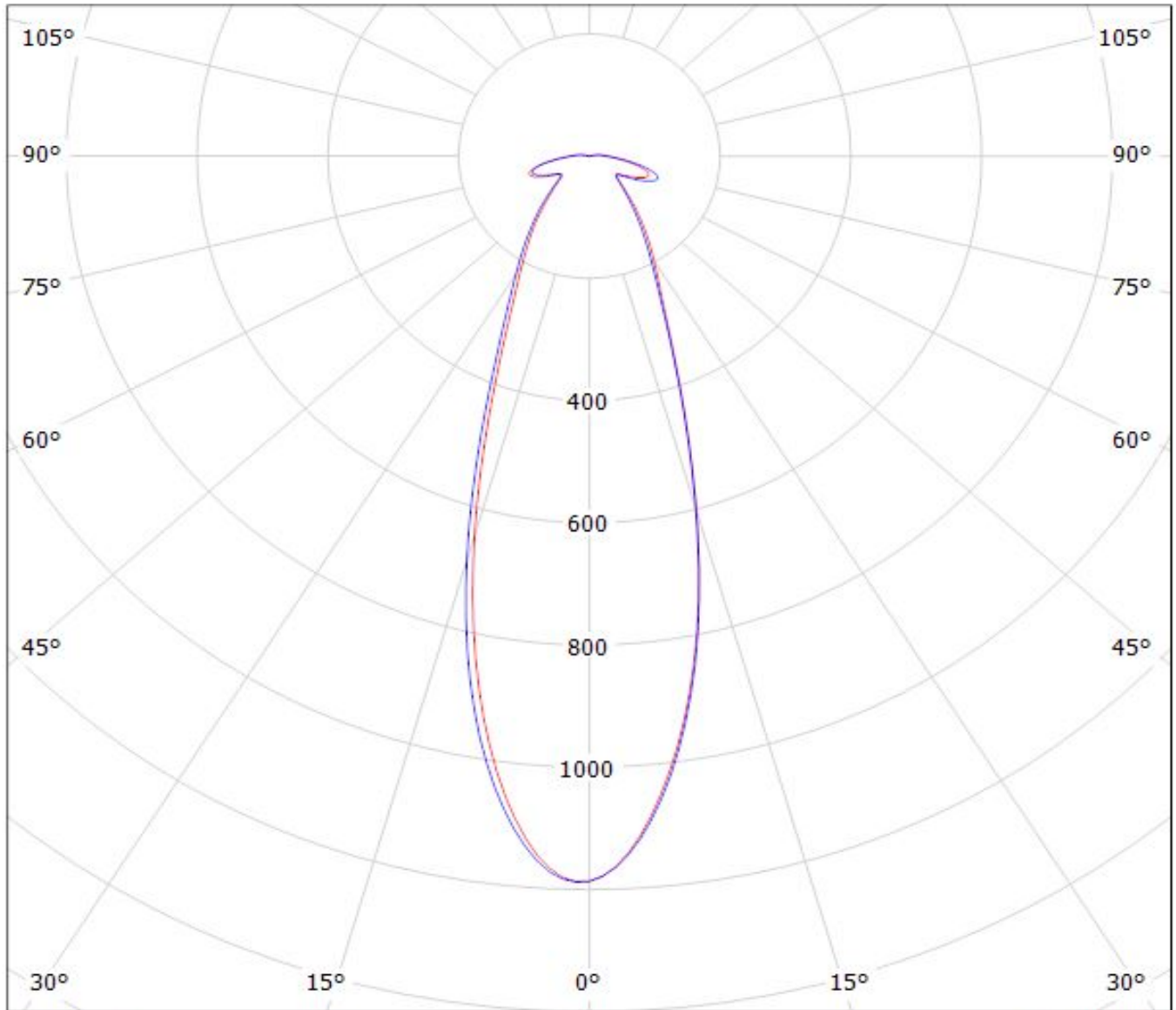

cd/klm

$\eta = 87\%$

— C0 - C180    — C90 - C270

Luminaire: Ledil FN14720\_STELLA-FRESNEL\_(MJT\_80W\_Les22)\_+Ideal\_50-2204CT

Lamps: 1 x Seoul\_MJT\_80W\_Les22mm\_(SAWx22AAA)\_+Ideal\_50-2204CT\_2497.65lm@250mA\_P=13.3118W\_I=0.25A

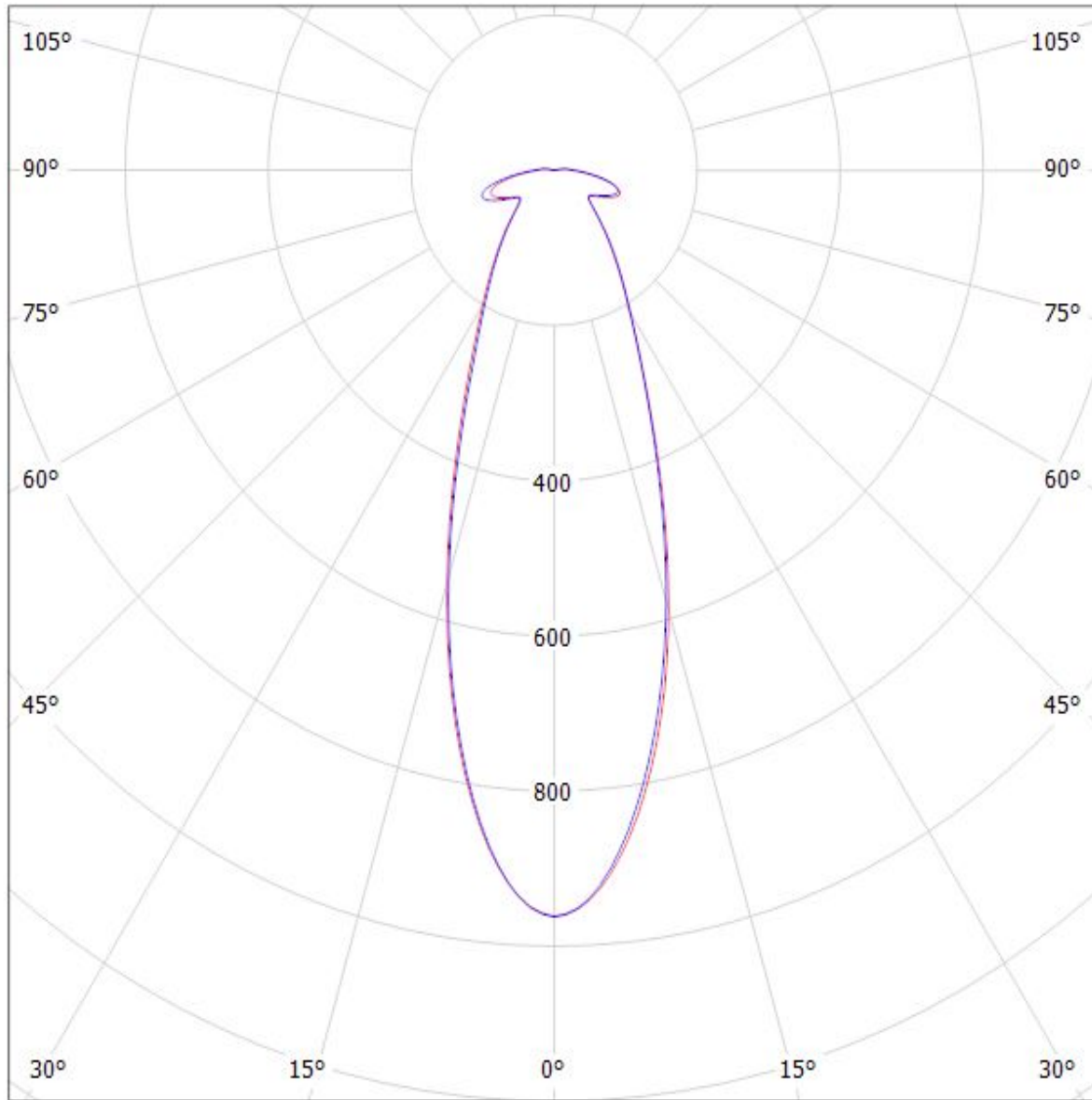

cd/klm

— C0 - C180

— C90 - C270

$\eta = 84\%$

Luminaire: Ledil FN14720\_STELLA-FRESNEL\_(MJT\_30W\_Les14,5)\_+50-2103CT

Lamps: 1 x Seoul\_MJT\_30W\_Les14,5mm\_(SAWx1566A)\_50-2103CT\_1339.05lm@250mA\_P=8.2275W\_I=0.25A

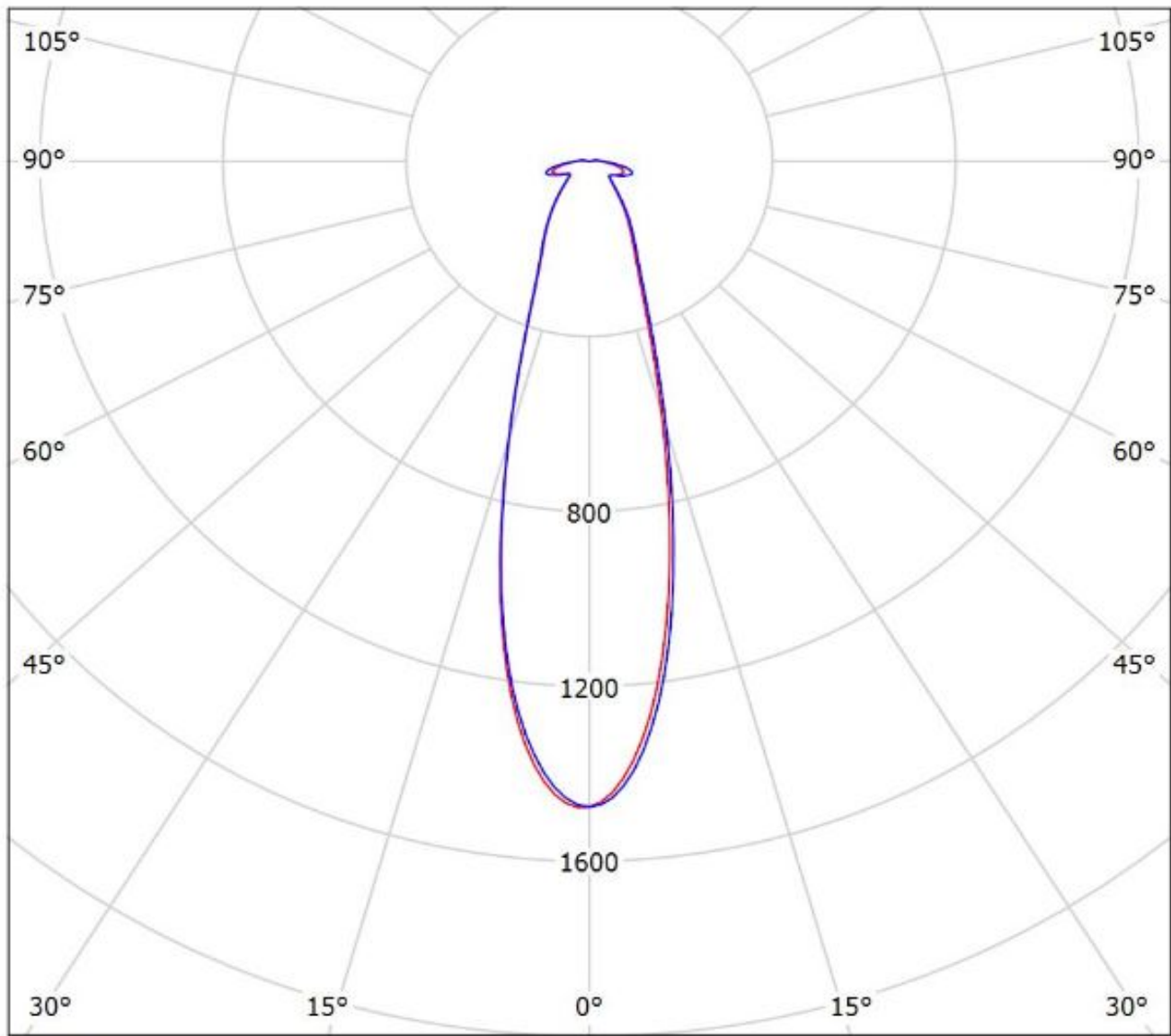

cd/klm

— C0 - C180 — C90 - C270

$\eta = 86\%$

Luminaire: LEDiL Oy FN14720\_STELLA-FRESNEL\_(SLE-G5\_LES-19)  
Lamps: 1 x Tridonic\_SLE-G5\_LES-19\_1189.9lm@250mA\_P=8.3068W\_I=0.250A

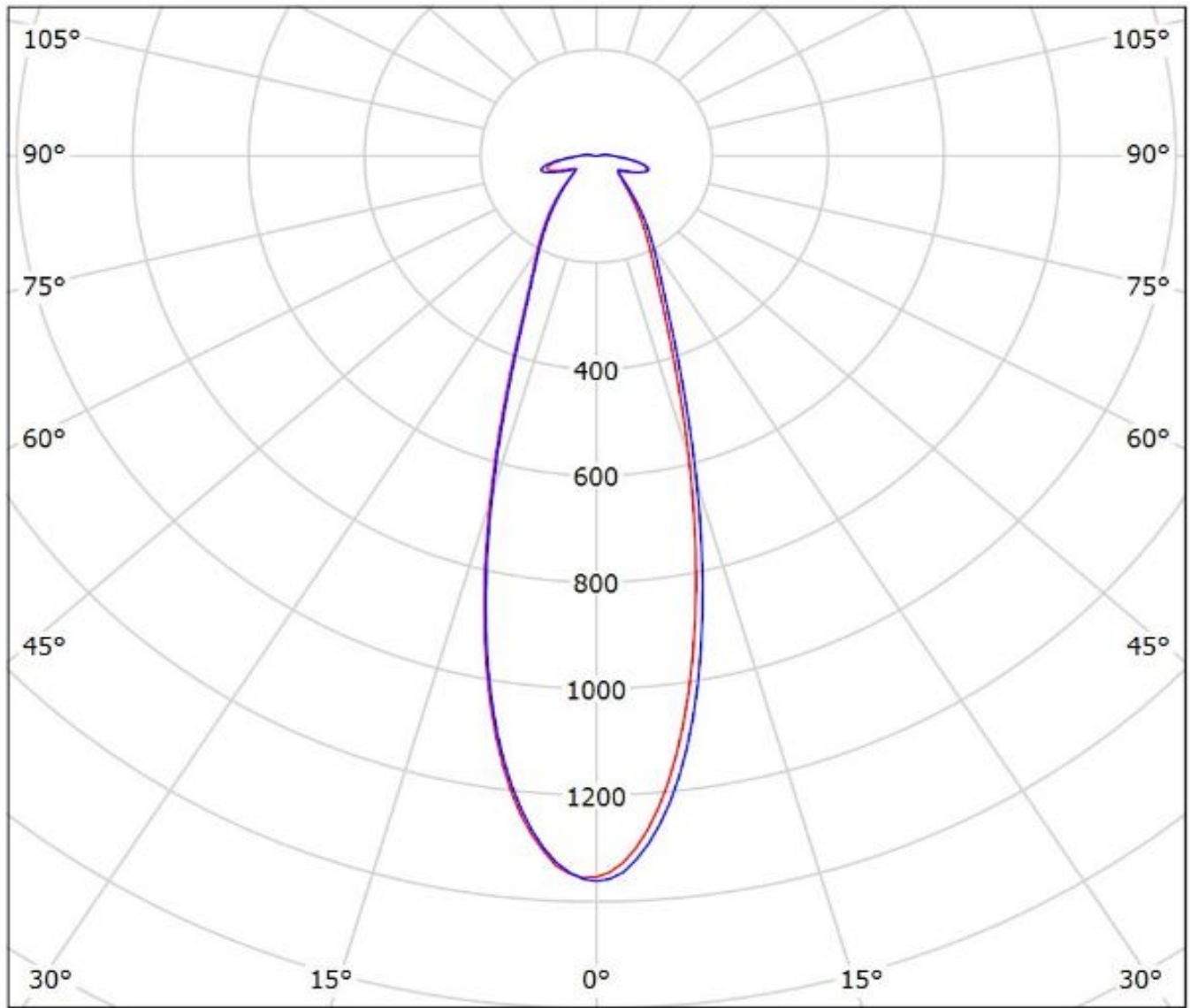

cd/klm

— C0 - C180 — C90 - C270

$\eta = 86\%$

Luminaire: LEDiL Oy FN14720\_STELLA-FRESNEL\_(SLE-G5\_LES-23)

Lamps: 1 x Tridonic\_SLE-G5\_LES-23\_1408.28lm@250mA\_P=8.1392W\_I=0.250A

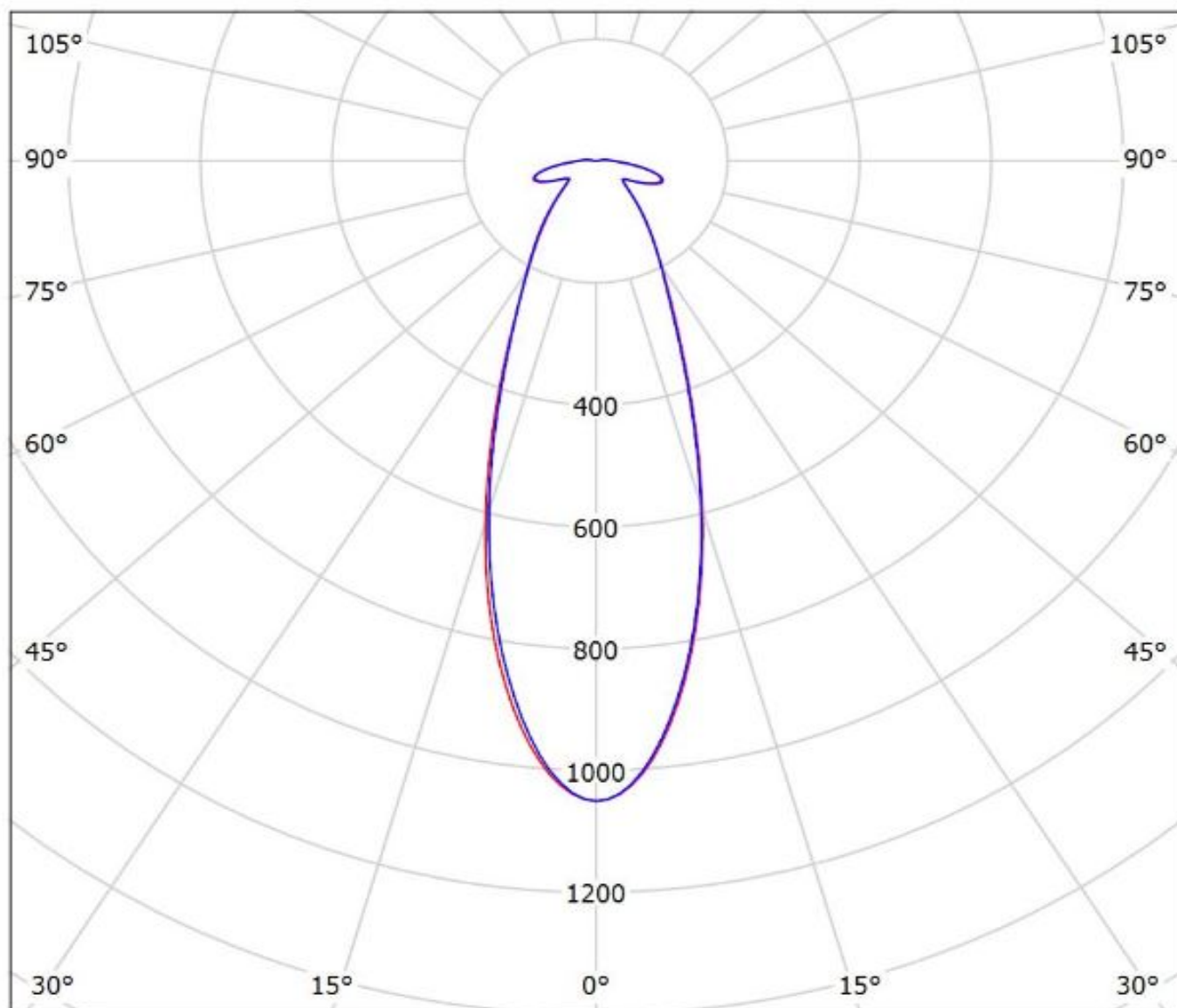

cd/klm

— C0 - C180 — C90 - C270

$\eta = 86\%$



**NOTE: The typical divergence will be changed by different color, chip size and chip position tolerance. The typical total divergence is the full angle measured where the luminous intensity is half of the peak value.**

### **GENERAL INFORMATION**

- Product series especially designed & optimized for series of LEDs.
- Special care taken to make light distribution as uniform as possible.

Note! Due to use of high power COB's with this product, special attention to proper thermal design is highly recommended. LEDiL has no liability for direct, indirect or consecutive damages arising from the LEDiL products being used outside of the recommended temperature range.