

DETAILS

Product Number	FN13323_STELLA-A
Family	STELLA
Type	Pack
Color	black
Diameter	90 mm
Height	22 mm
Style	round
Optic Material	Silicone
Holder Material	PA66GF30
Fastening	screw
Status	ready
ROHS Compliant	Yes
Date Updated	5/03/2015



OPTICAL PROPERTIES

LED	Viewing Angle	Light Beam	Efficiency	cd/lm	Connector
LUXEON CoB 1202/1203	Asym deg	Asymmetric	88 %	0.910	Bender Wirth: 438 Typ L1
NSBxL066A/NFCxL036B	Asymmetric deg	Asymmetric	90 %	0.930	Bender Wirth: 438 Typ L1
CXM-18	Asymmetric deg	Asymmetric	89 %	0.460	-
V15	Asymmetric deg	Asymmetric	91 %	0.550	-
Soleriq P13	Asym deg	Asymmetric	90 %	0.610	-
CXA25xx	Asymmetric deg	Asymmetric	93 %	0.490	-
CXA15xx	Asymmetric deg	Asymmetric	92 %	1.100	-
Soleriq S13	Asymmetric deg	Asymmetric	91 %	0.700	-
CLU710	Asymmetric deg	Asymmetric	89 %	0.960	-
CLU720	Asym deg	Asymmetric	sim: 90 %	0.730	-
CLU730	sim: Asymmetric	Asymmetric	sim: 90 %	sim: 0.000	-
VERO13	Asymmetric deg	Asymmetric	92 %	0.660	-
VERO18	Asymmetric deg	Asymmetric	92 %	0.500	-
Soleriq P13	Asymmetric deg	Asymmetric	94 %	0.660	Bender Wirth: 437 Typ L1
Soleriq S13	Asymmetric deg	Asymmetric	92 %	0.690	Bender Wirth: 437 Typ L1
CXM-14	Asym deg	Asymmetric	90 %	0.580	-
CLL03x/CLU034	Asymmetric deg	Asymmetric	92 %	0.616	-
CXA1816/CXA1820/CXA1850	Asym deg	Asymmetric	89 %	0.670	Bender Wirth: 437 Typ L1
LUXEON CoB 1208	Asymmetric deg	Asymmetric	-	0.300	-
CXA1816/CXA1820/CXA1850	Asym deg	Asymmetric	87 %	0.670	-
Soleriq S19	Asymmetric deg	Asymmetric	90 %	0.500	-
Mega Zenigata (GW6DME)	Asym deg	Asymmetric	90 %	0.570	-
L121A/L060B/L024Z	Asymmetric deg	Asymmetric	89 %	0.720	Bender Wirth: 438 Typ L1
Soleriq P9	Asym deg	Asymmetric	88 %	0.900	Bender Wirth: 461 Typ L1

H G F E D C B A

Front view

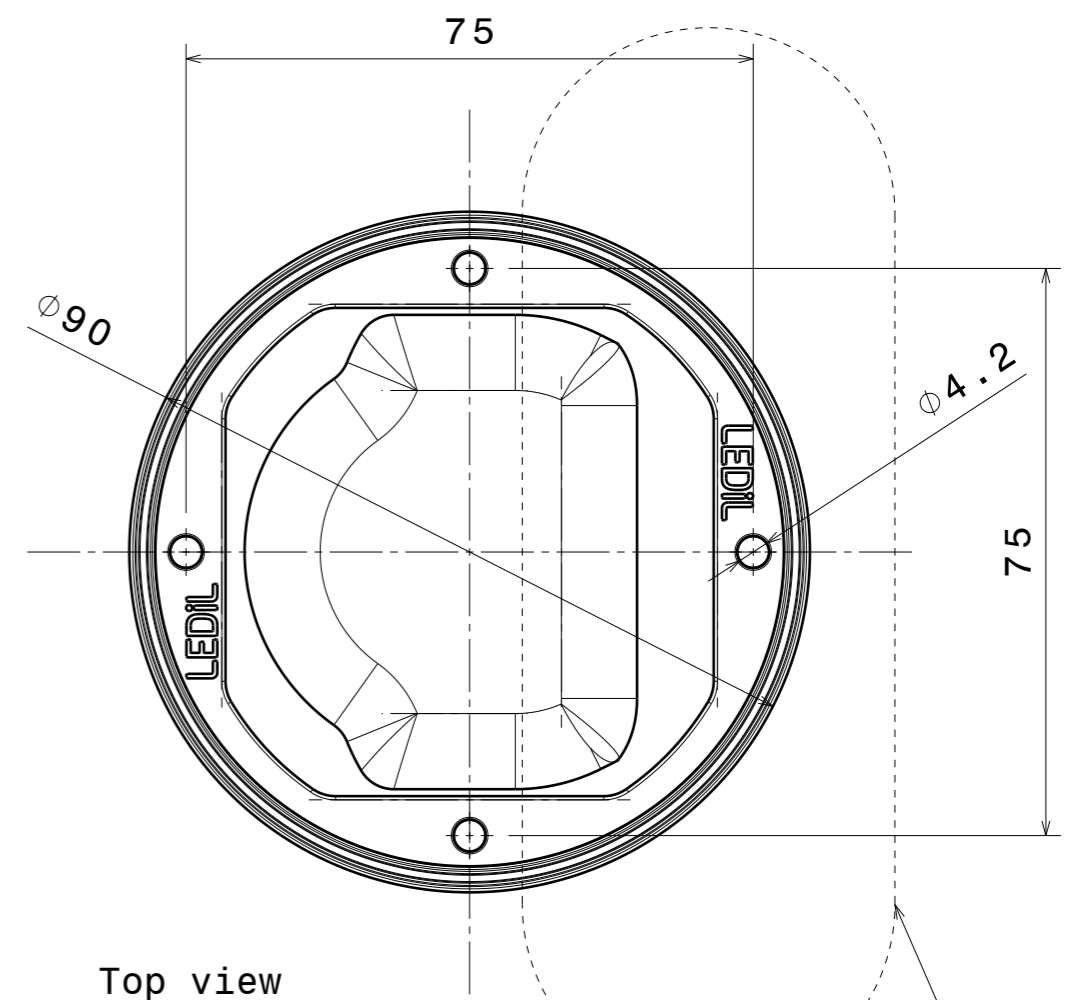
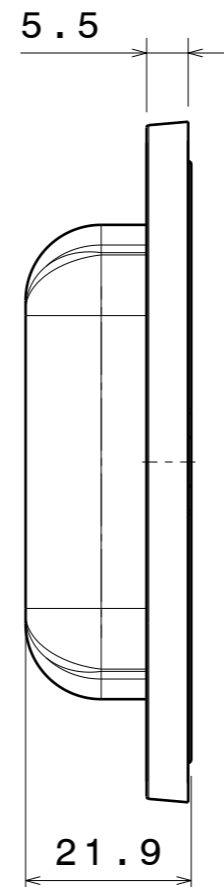
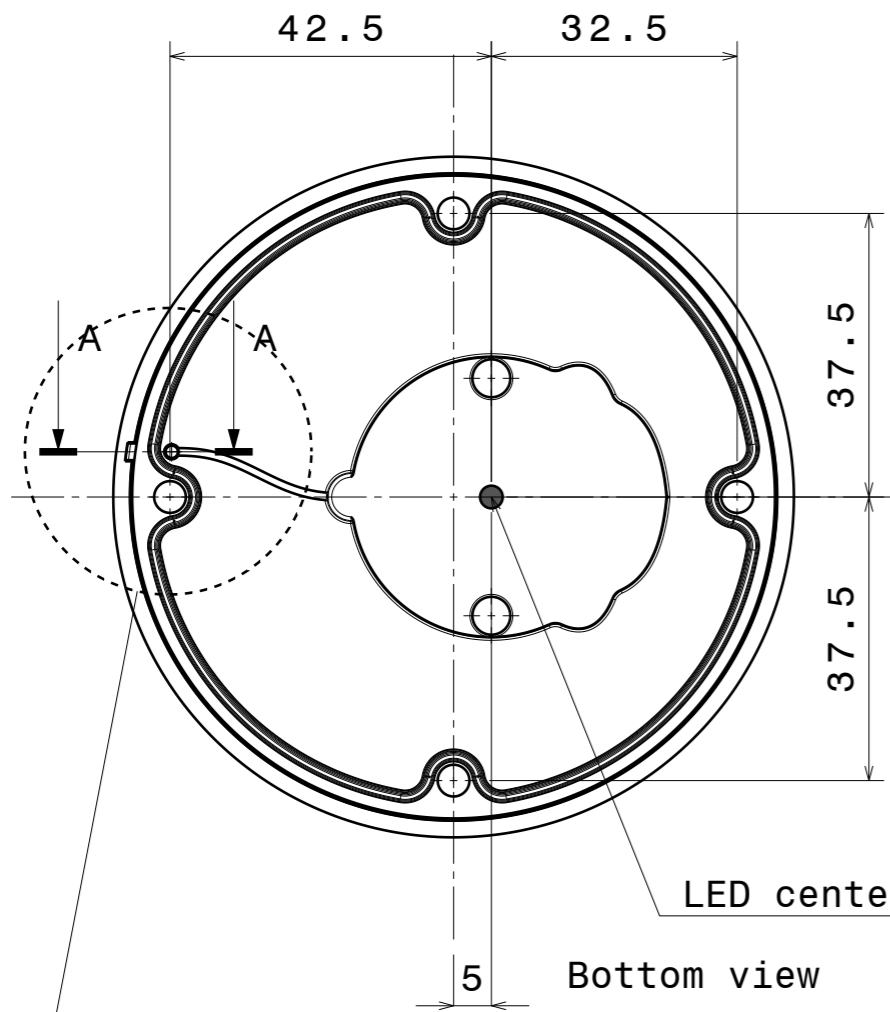

Top view

Light beam direction

Bottom view

Isometric view

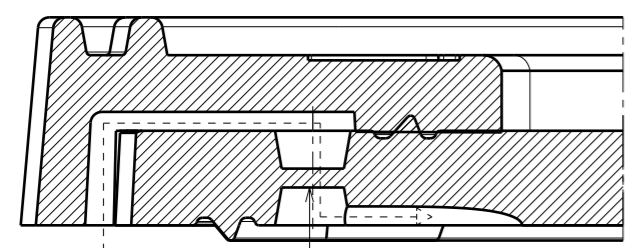

Section view A-A
Scale: 5:1

Venting pipe:
Piercing this membrane
will Allow lens breathing

Lens material: Optical grade LSR
Frame material: PA66GF30, black

<small>Tolerances if not otherwise shown According to DIN ISO 2768-1 Linear measures: Up to 30mm class M, otherwise class C. According to DIN ISO 2768-2 Form and position: class L</small>		 Ledil Oy Salorankatu 10 FIN 24240 SALO Finland	
THIRD ANGLE PROJECTION: 		DRAWING TITLE STELLA-A datasheet	
SIZE A3	PART NUMBER FN13323		
SCALE 1:1	WEIGHT (g)	SHEET 1/1	

H G B A

Luminaire: LEDiL Oy FN13323_STELLA-A (Luxeon_CoB_1203) (438_Typ_L1)
Lamps: 1 x Luxeon_CoB_1203_(LHC1-3080-1203)_(438_Typ_L1)_1005.18lm@250mA_P=8.69829W_I=0.2498A

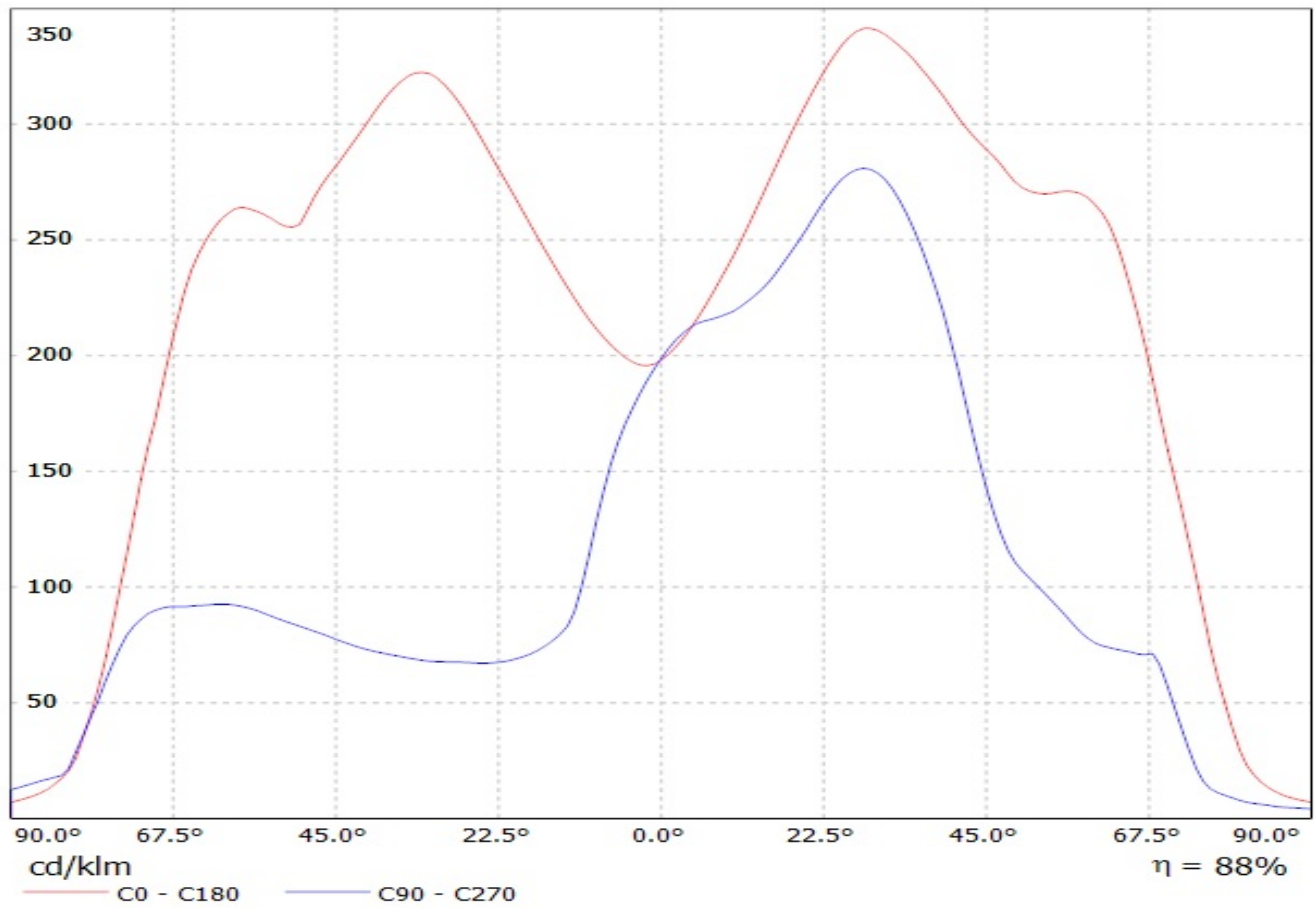

Ledil FN13323_STELLA-A_(NFCLL036B) / LDC (Linear)

Luminaire: Ledil FN13323_STELLA-A_(NFCLL036B)
Lamps: 1 x Nichia_NFCLL036B_(SM403J1300R8000)
_563.488lm@100mA_CCT=4000K_P=3.35W_I=0.100A

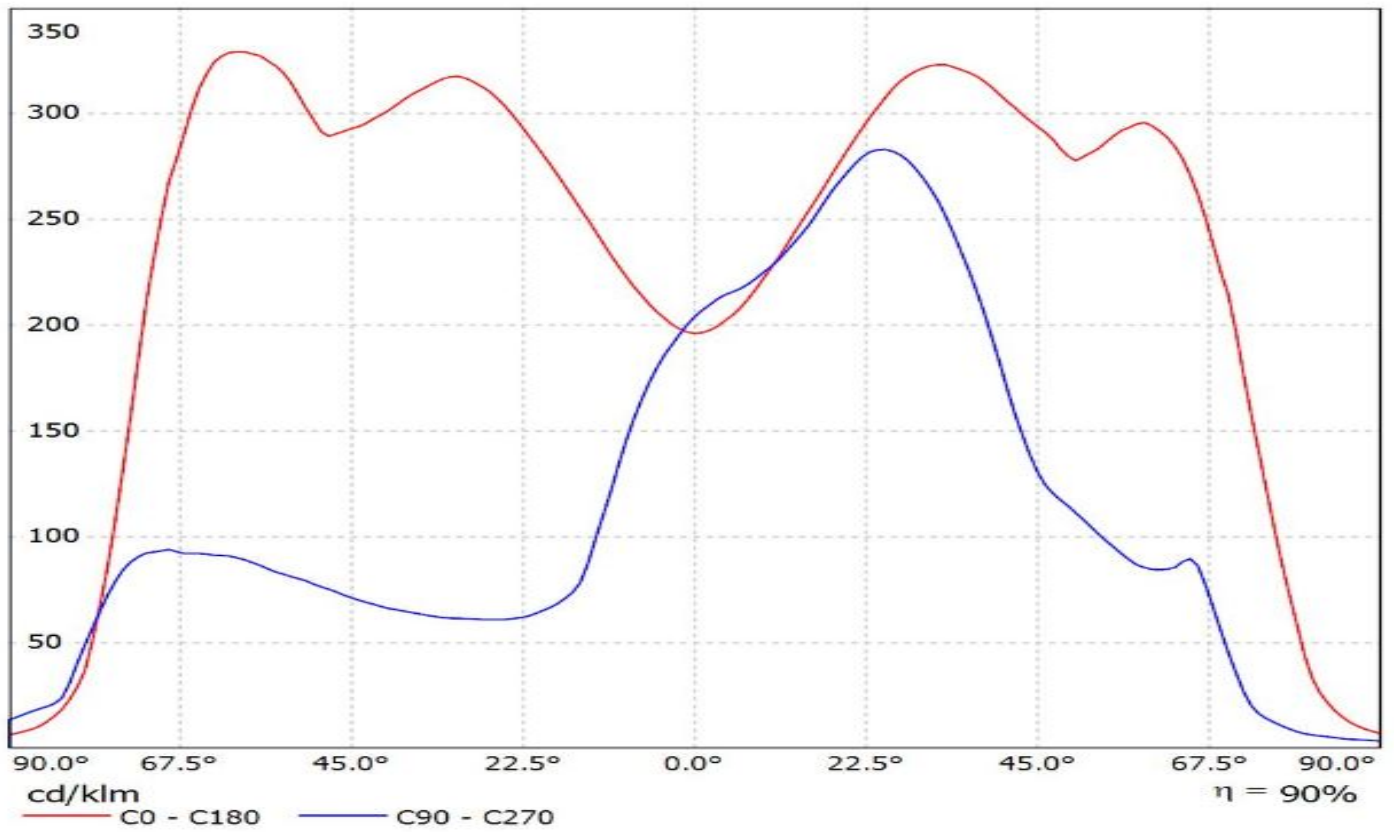

Luminaire: LEDiL Oy FN13323_STELLA-A_(CXM-18) Eff.89.2%
Lamps: 1 x LUMINUS_XNOVA_CXM-18_897.842lm@250mA_P=8.12425W_I=249.9mA

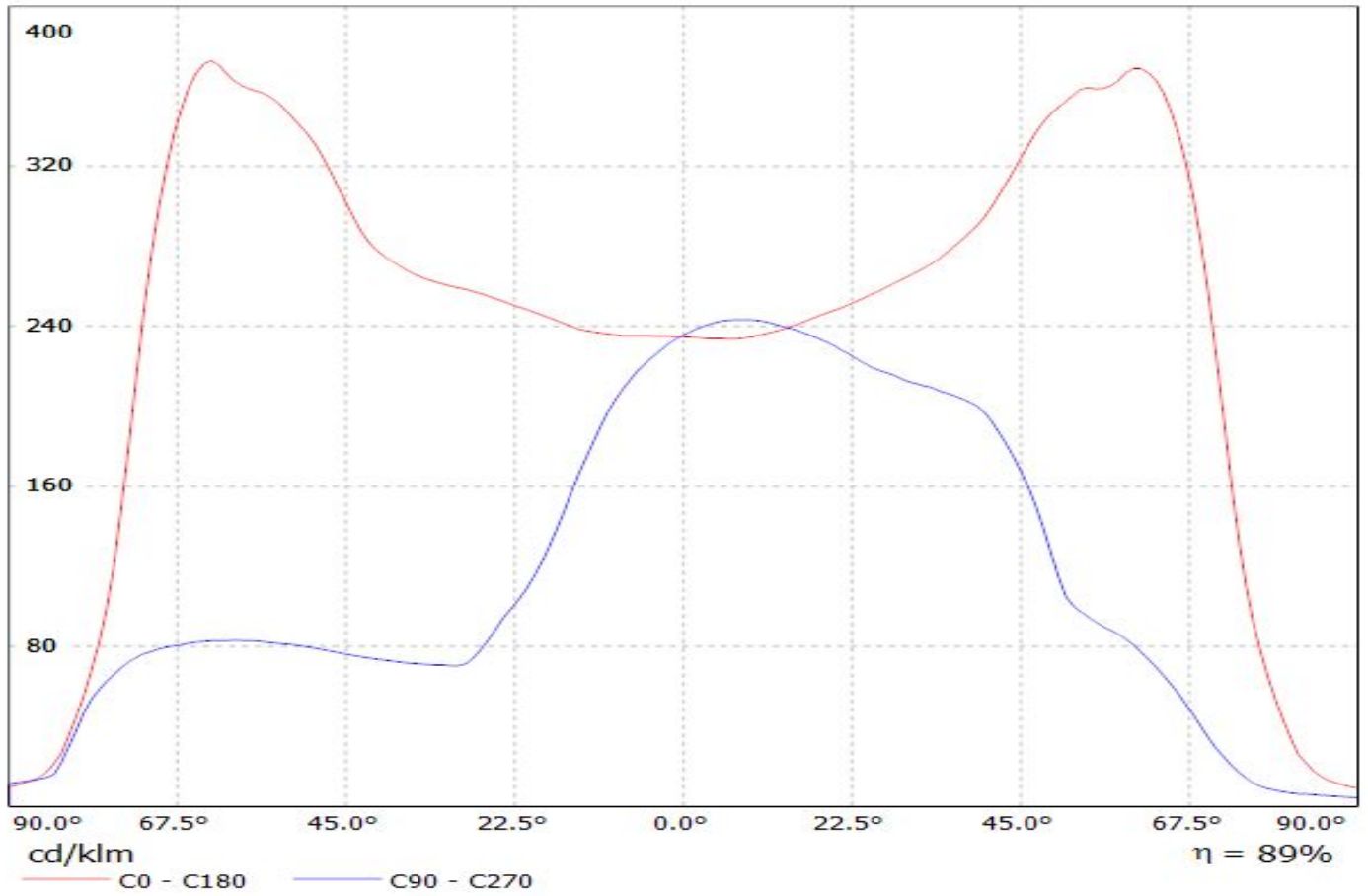

Luminaire: LEDiL Oy FN13323_STELLA-A_(V15)

Lamps: 1 x Bridgelux_V15_1050.21lm@250mA_P=8.19169W_I=249.8mA

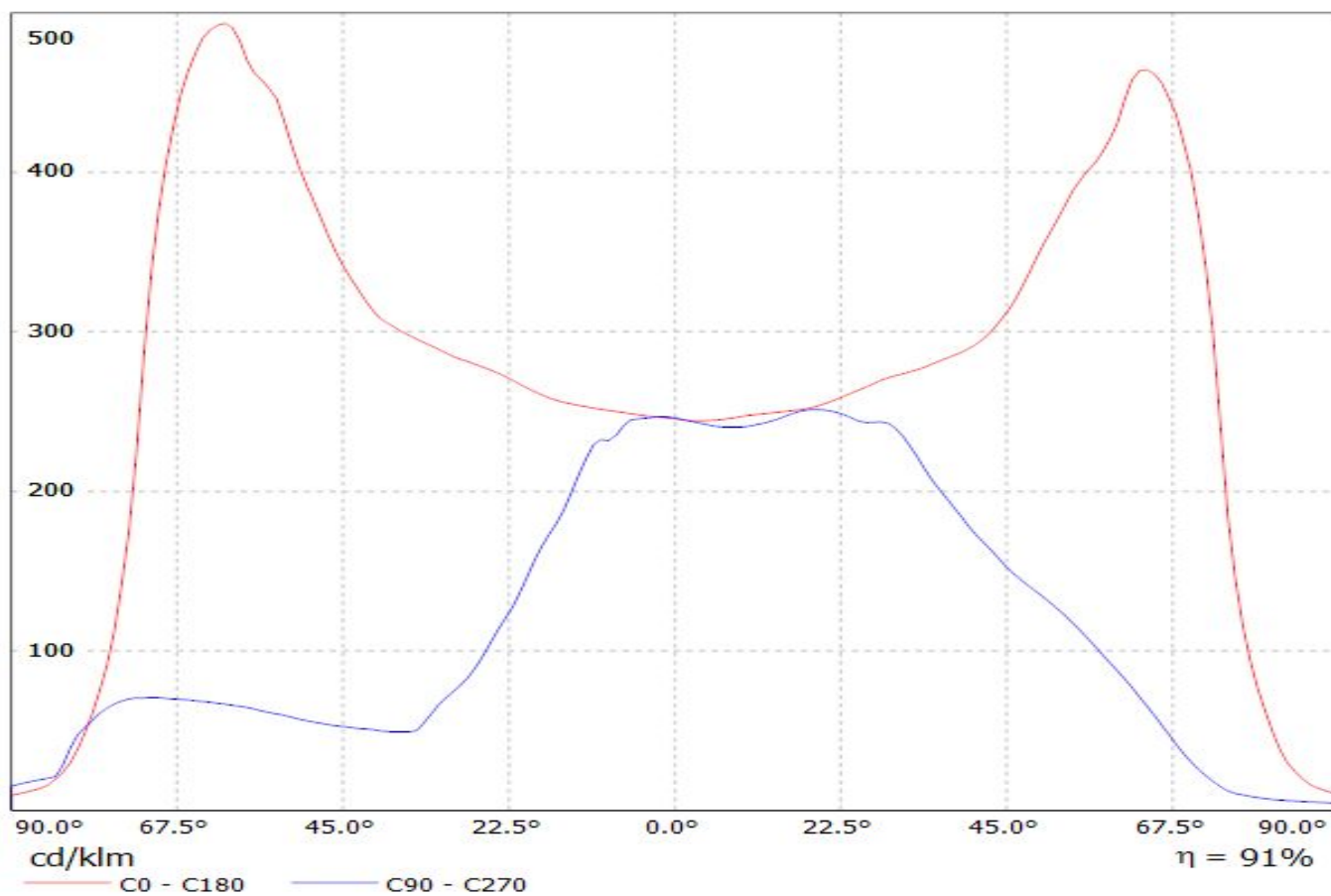

Luminaire: LEDiL Oy FN13323_STELLA-A_(SOLERIQ_P13)

Lamps: 1 x SOLERIQ_P13_(GW_MAGMB1.EM)_929.576lm@250mA_CCT=3500K_P=8.72876W_I=249.8mA

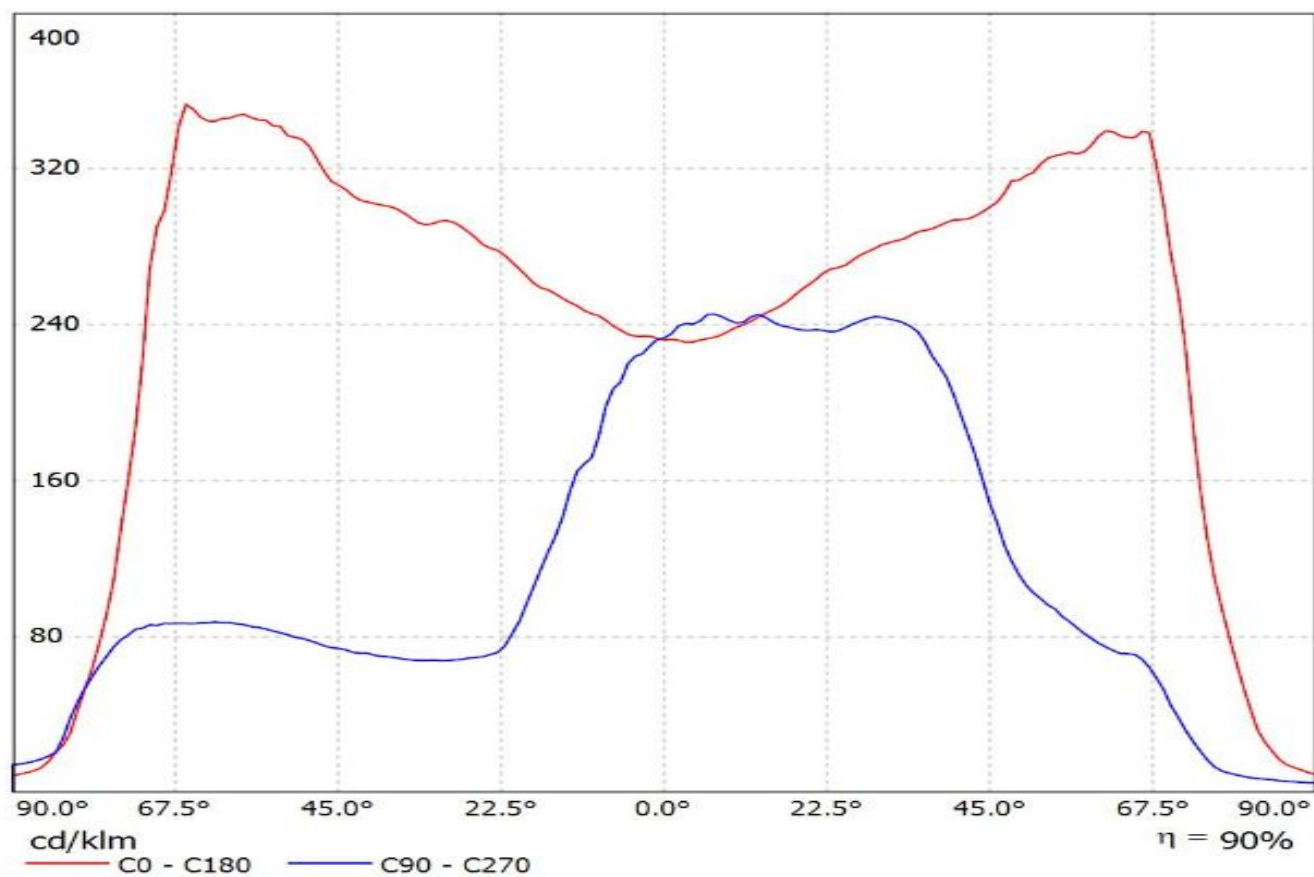

Luminaire: LEDiL Oy FN13323_STELLA-A_(CXA25) Eff. 93%
Lamps: 1 x CREE_CXA25 (CXA2530-7C0-T2-N0H)1100lm@250mA CCT=3000K P=8W I=250mA

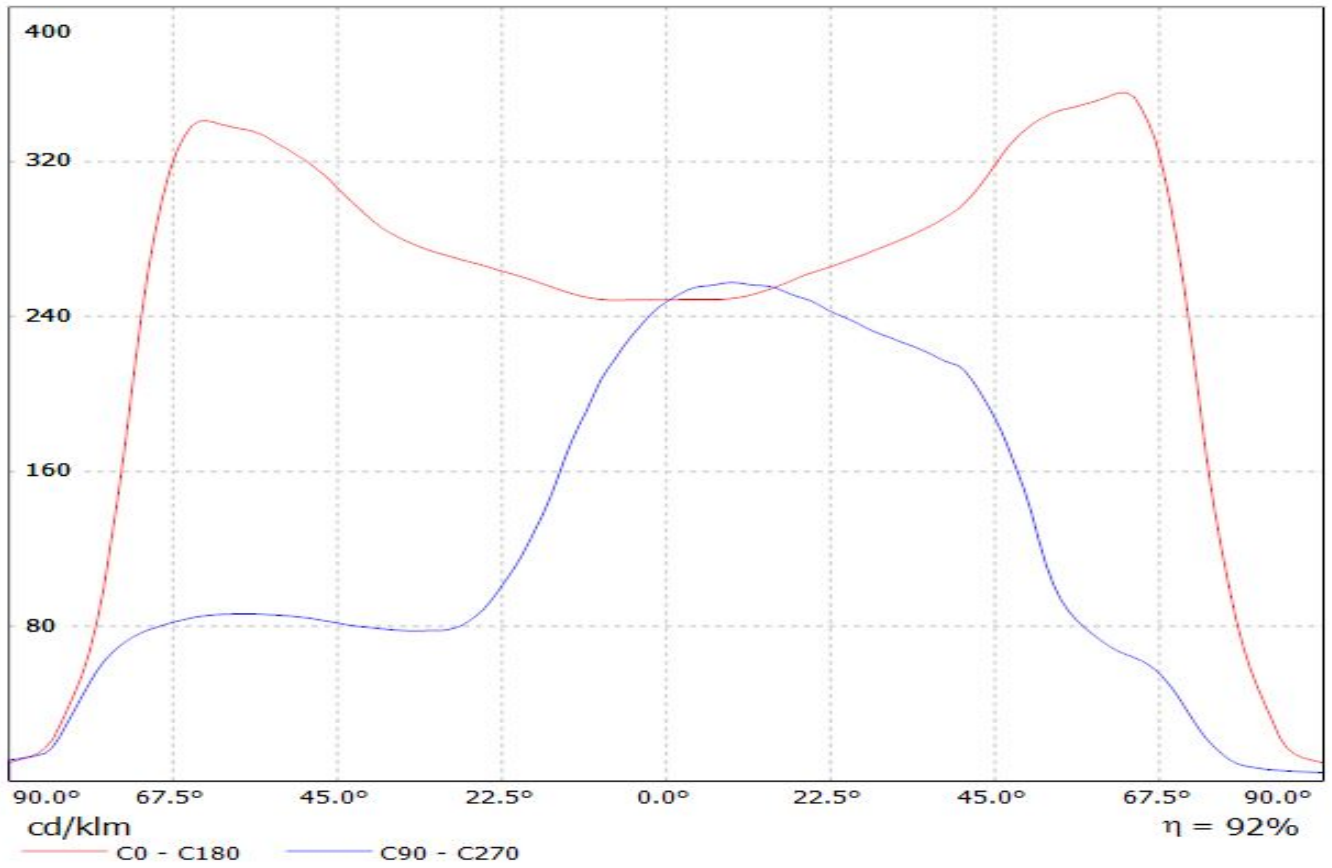

Luminaire: LEDiL Oy FN13323_STELLA-A_(CXA1507) Eff: 92%
Lamps: 1 x Cree_CXA1507_(CXA1507-30F-F2-N0A-0000) 220lm@50mA CCT=3000K P=2W I=50mA

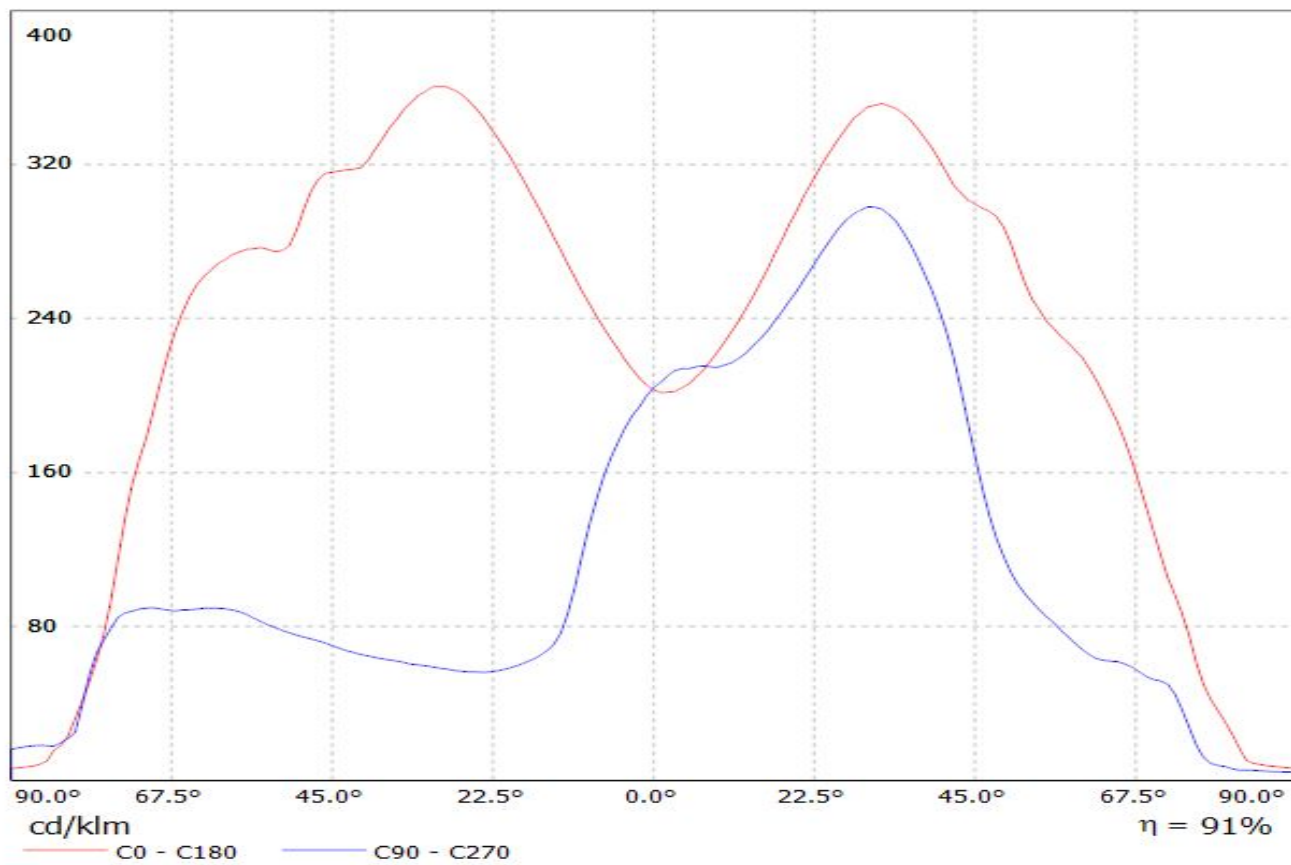

Luminaire: LEDiL Oy FN13323_STELLA-A_(Soleriq_S13)

Lamps: 1 x Osram_Soleriq_S13_802.964lm@250mA_CCT=3125K_P=7.26069W_I=249.8mA

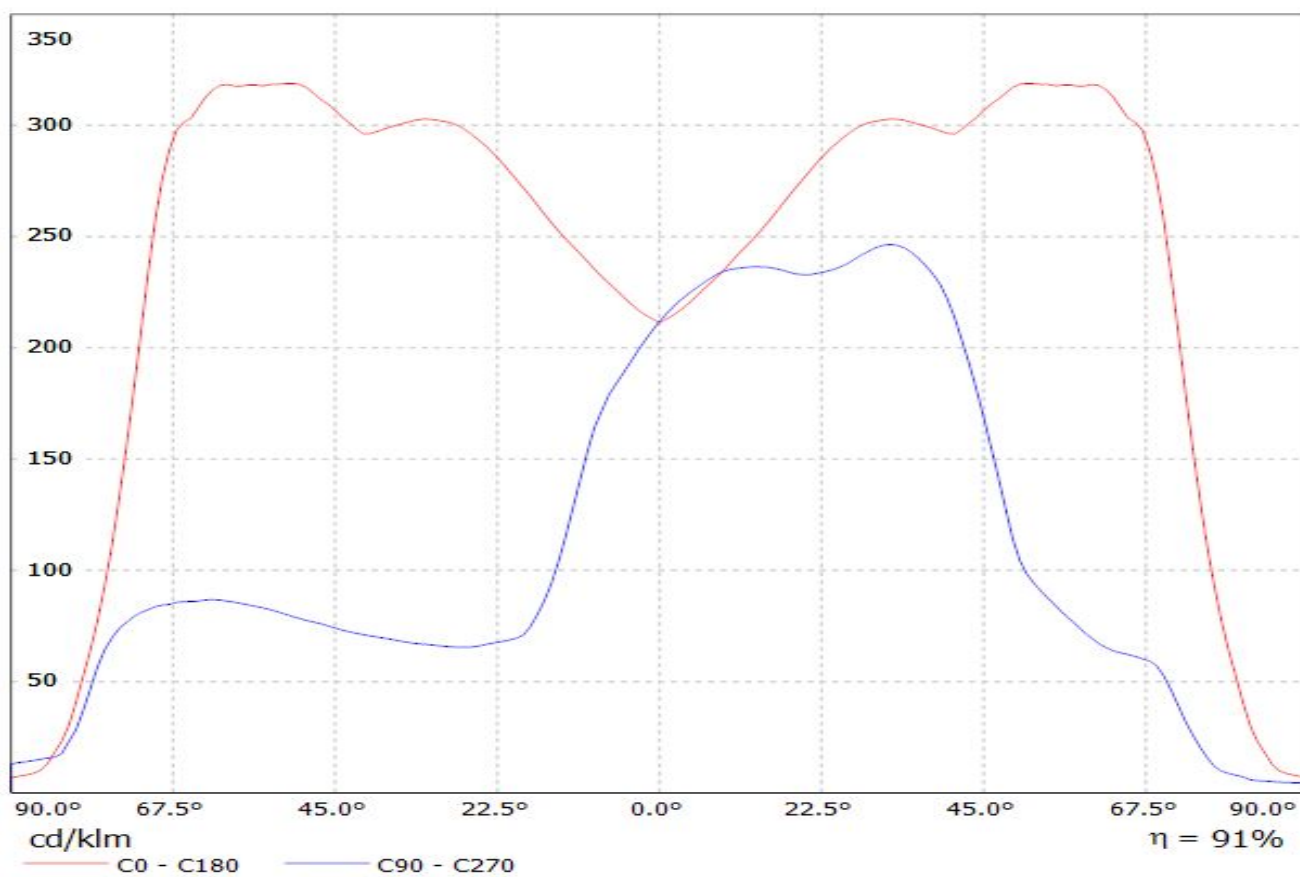

Luminaire: Ledil FN13323_STELLA-A_(CLU710)

Lamps: 1 x CITIZEN_CLU710_(CLU710-1204B8-273M2G1)_1212.66lm@250mA_P=8.5W_I=0.25A

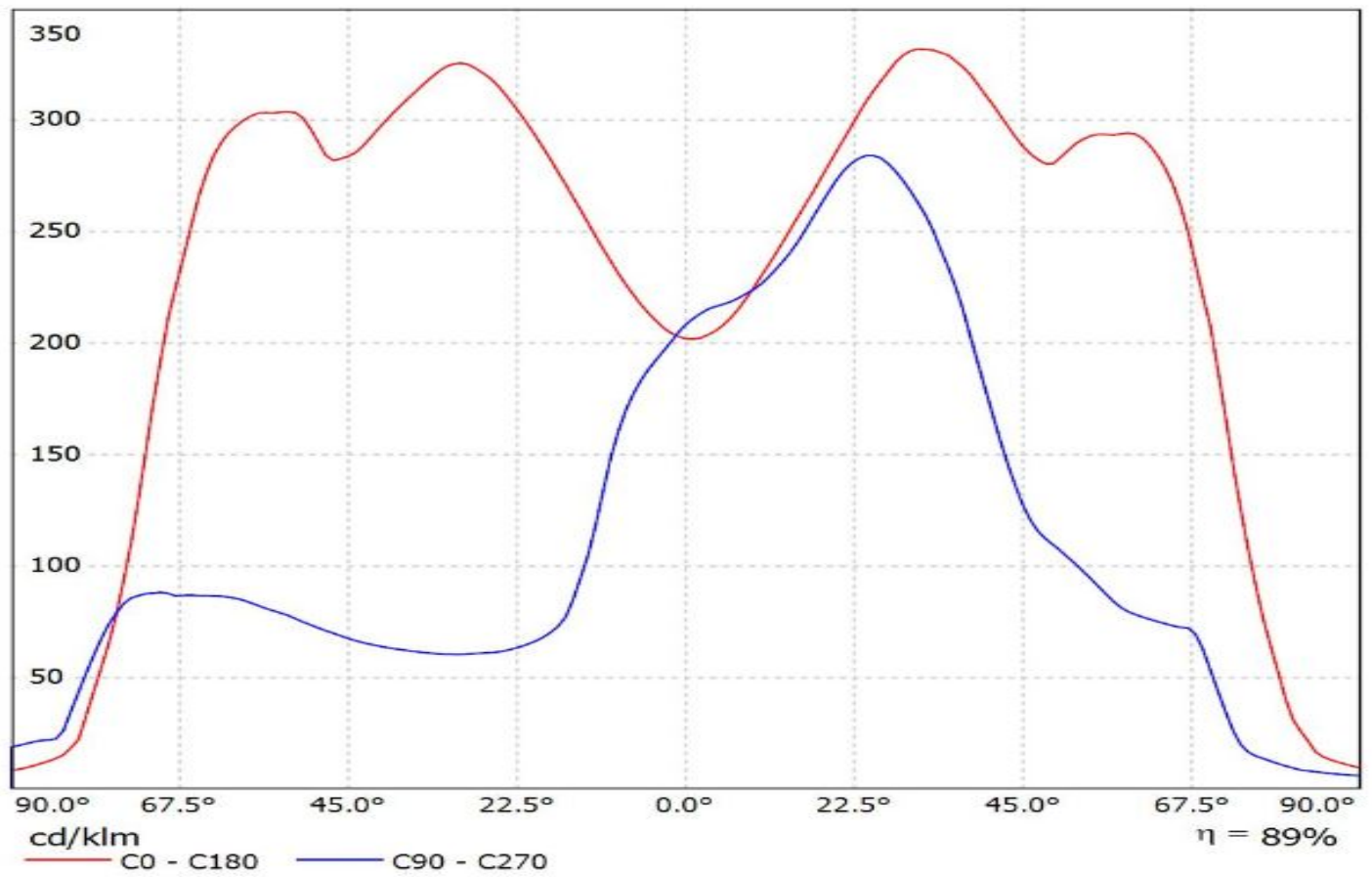

Ledil FN13323_STELLA-A_(CLU720) / LDC (Linear)

Luminaire: Ledil FN13323_STELLA-A_(CLU720)
Lamps: 1 x CITIZEN_CLU720_(CLU720-1206B8-273M2)
_1298.17lm@250mA_CCT=2700K_P=8.3W_I=0.25A

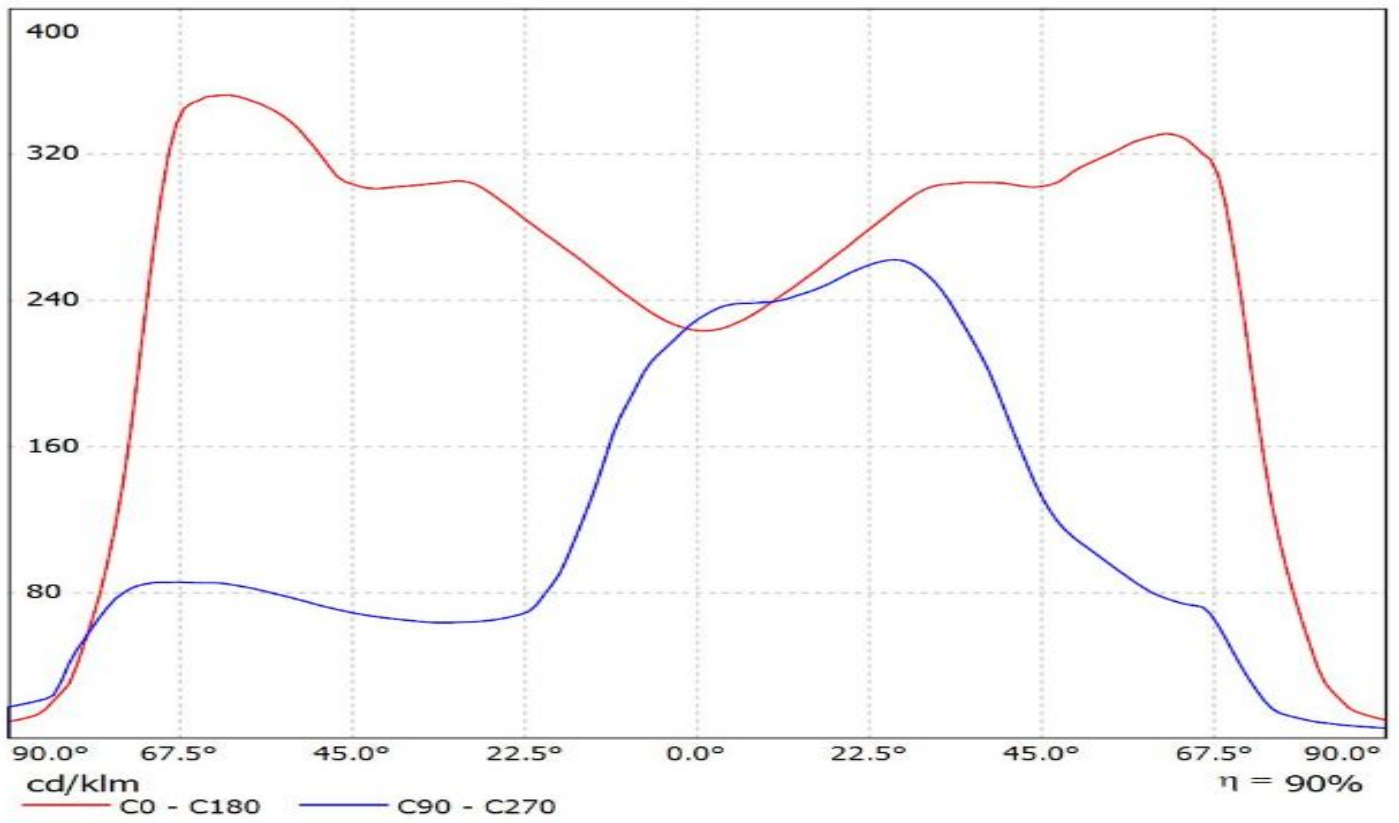

Luminaire: LEDiL Oy FN13323_STELLA-A Eff. 92%
Lamps: 1 x VERO13 (BXRC-30E4000F) 819lm@250mA CCT=3000K P=7.5W I=250mA

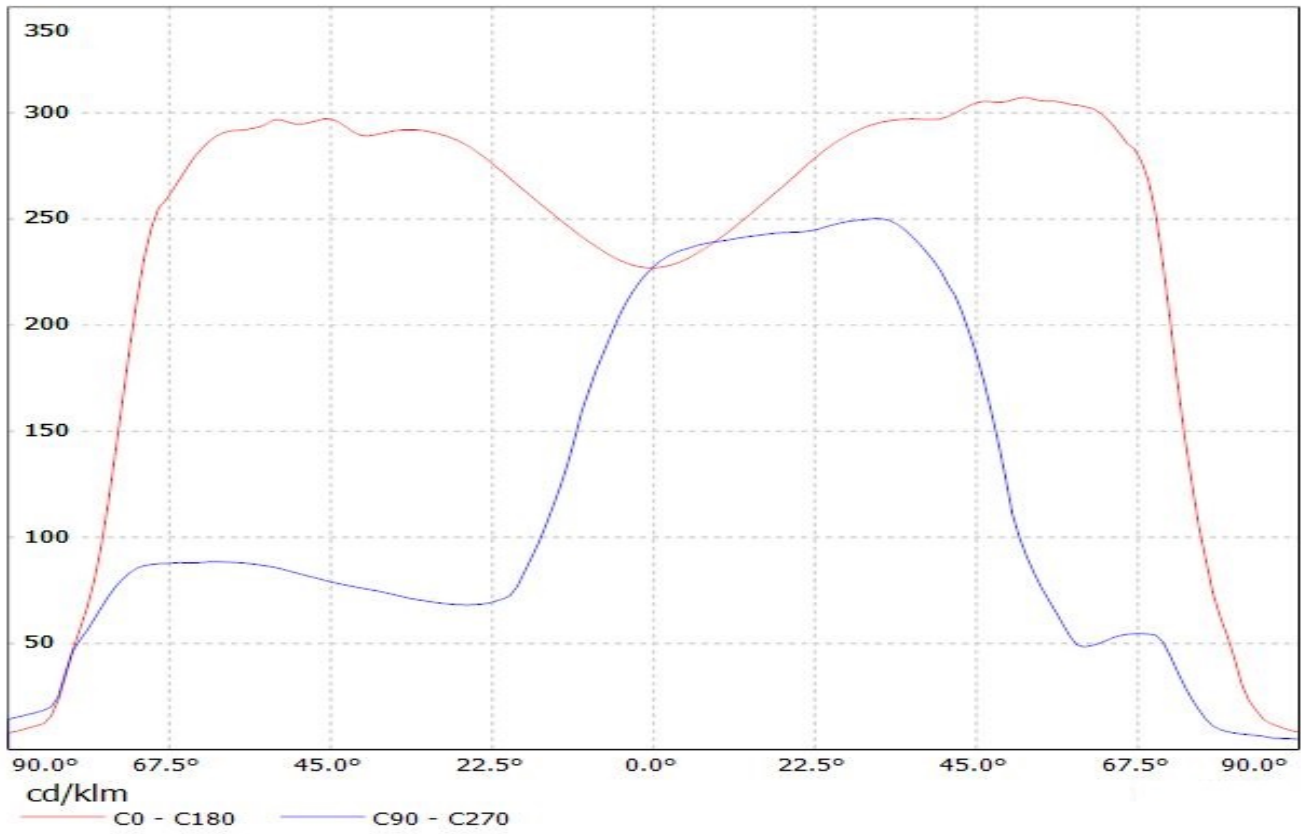

Luminaire: LEDiL Oy FN13323_STELLA-A (VERO18) Eff. 92%
Lamps: 1 x VERO18 (BXRC-30E4000F)786lm@250mA CCT=3000K P=6.84W I=250mA

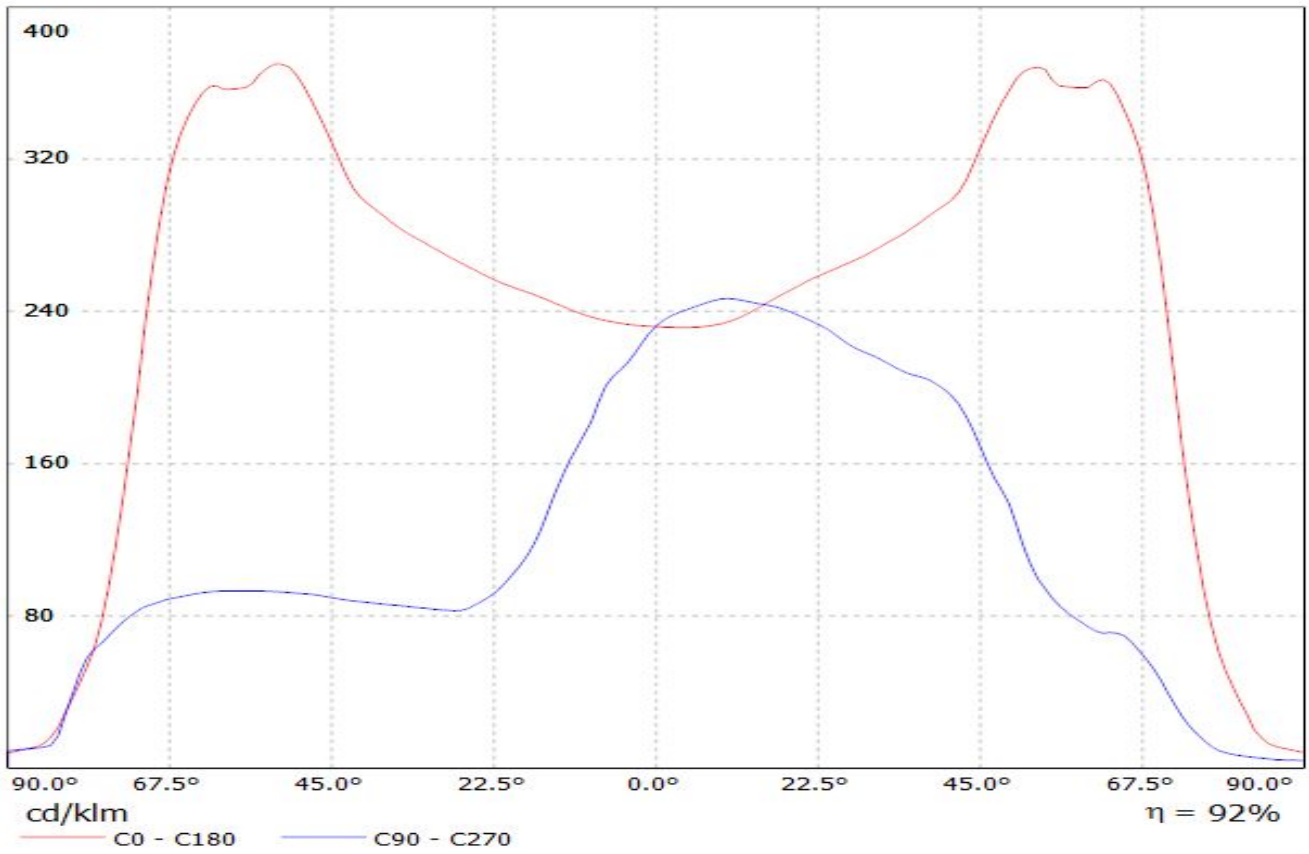

Ledil FN13323_STELLA-A_(P13) / LDC (Linear)

Luminaire: Ledil FN13323_STELLA-A_(P13)
Lamps: 1 x Osram Soleriq P13 (GW MAGMB1.EM)
_929.576lm@250mA_CCT=3500K_P=8.72876W_I=249.8mA

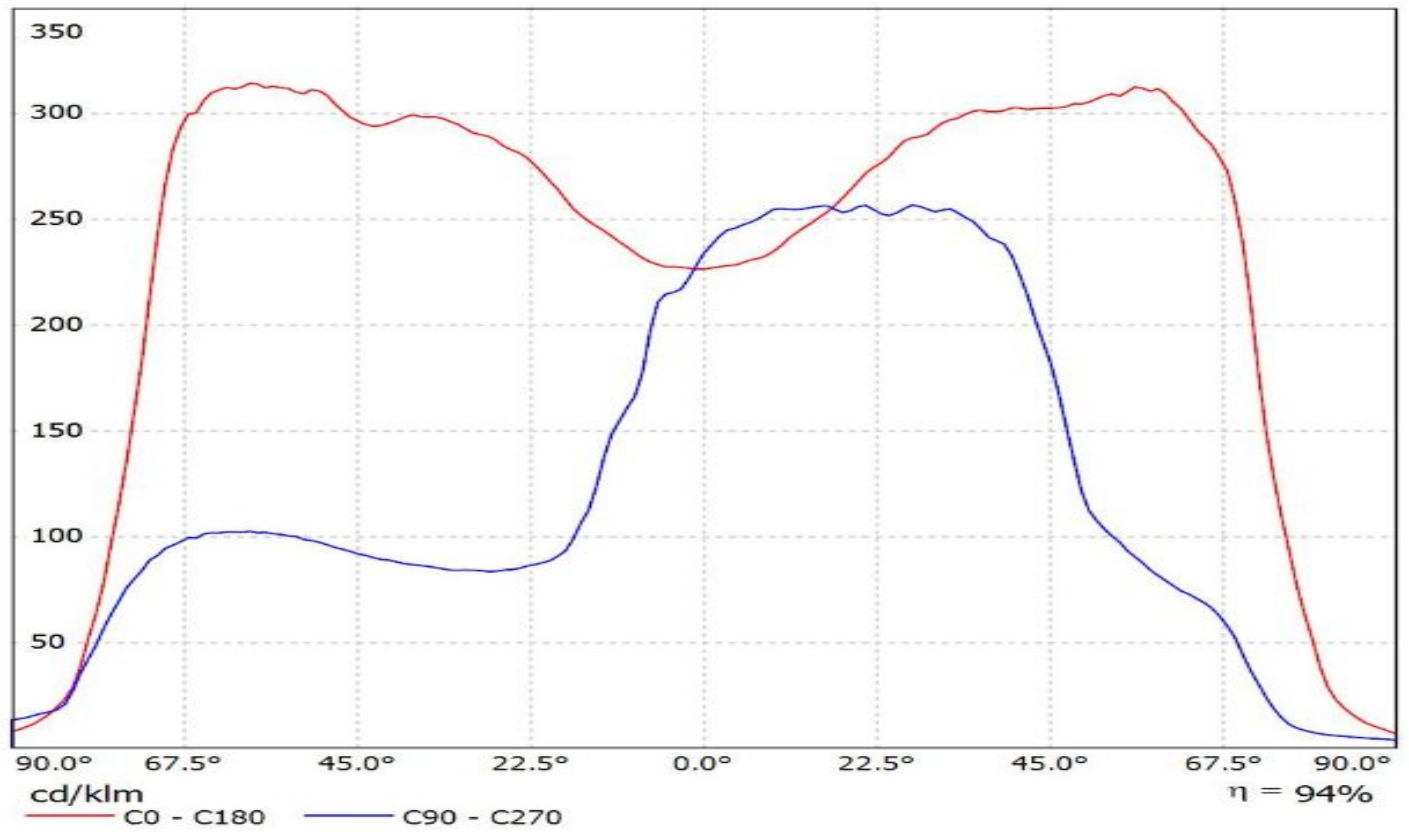

Ledil FN13323_STELLA-A_(Soleriq_S13) / LDC (Linear)

Luminaire: Ledil FN13323_STELLA-A_(Soleriq_S13)

Lamps: 1 x Osram_Soleriq_S13_(GW_KAGHB1.EM)_875.214lm@250mA_P=7.44679W_I=250mA

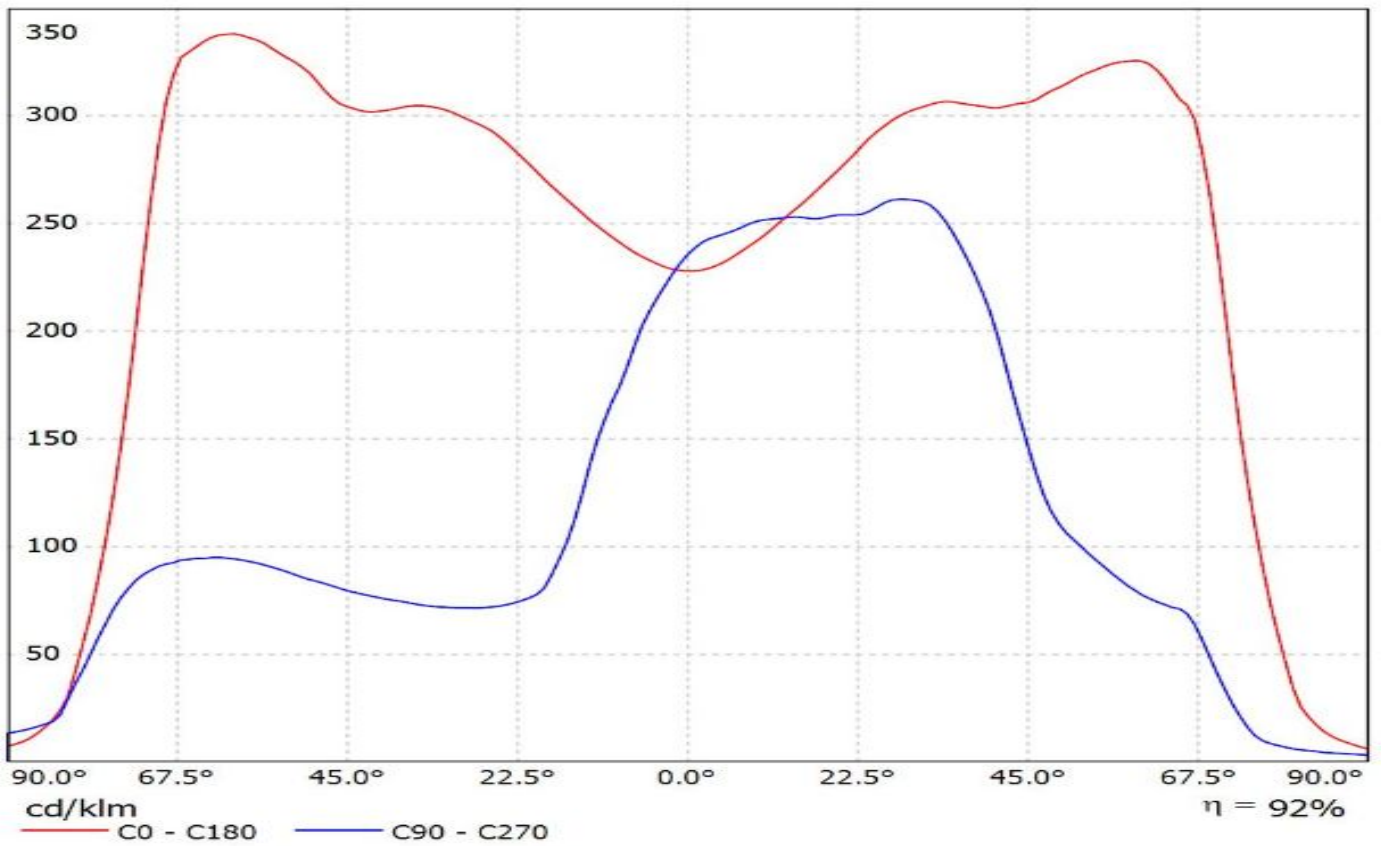

Luminaire: LEDiL Oy FN13323_STELLA-A_(CXM-14)
Lamps: 1 x LUMINUS_XNOVA_CXM-14_(AC00)
_1064.17lm@250mA_CCT=3133K_P=8.33558W_I=249.8mA

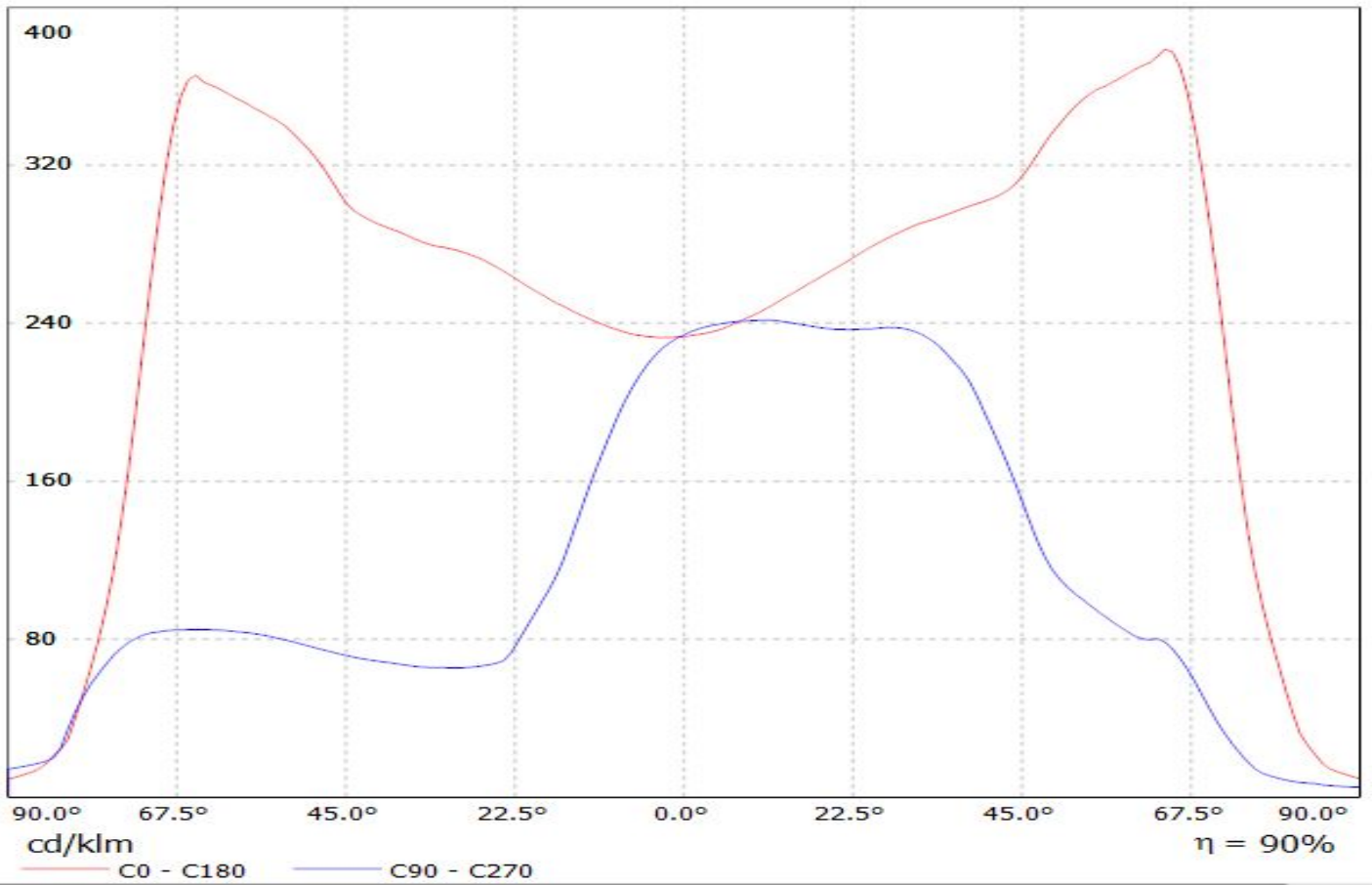

Luminaire: LEDiL Oy FN13323_STELLA-A_(CLL030) Eff. 92%

Lamps: 1 x Citizen_CLL030_(CLL030-1205A5-303H1A7) 690lm@250mA CCT=3000K P=9W I=250mA

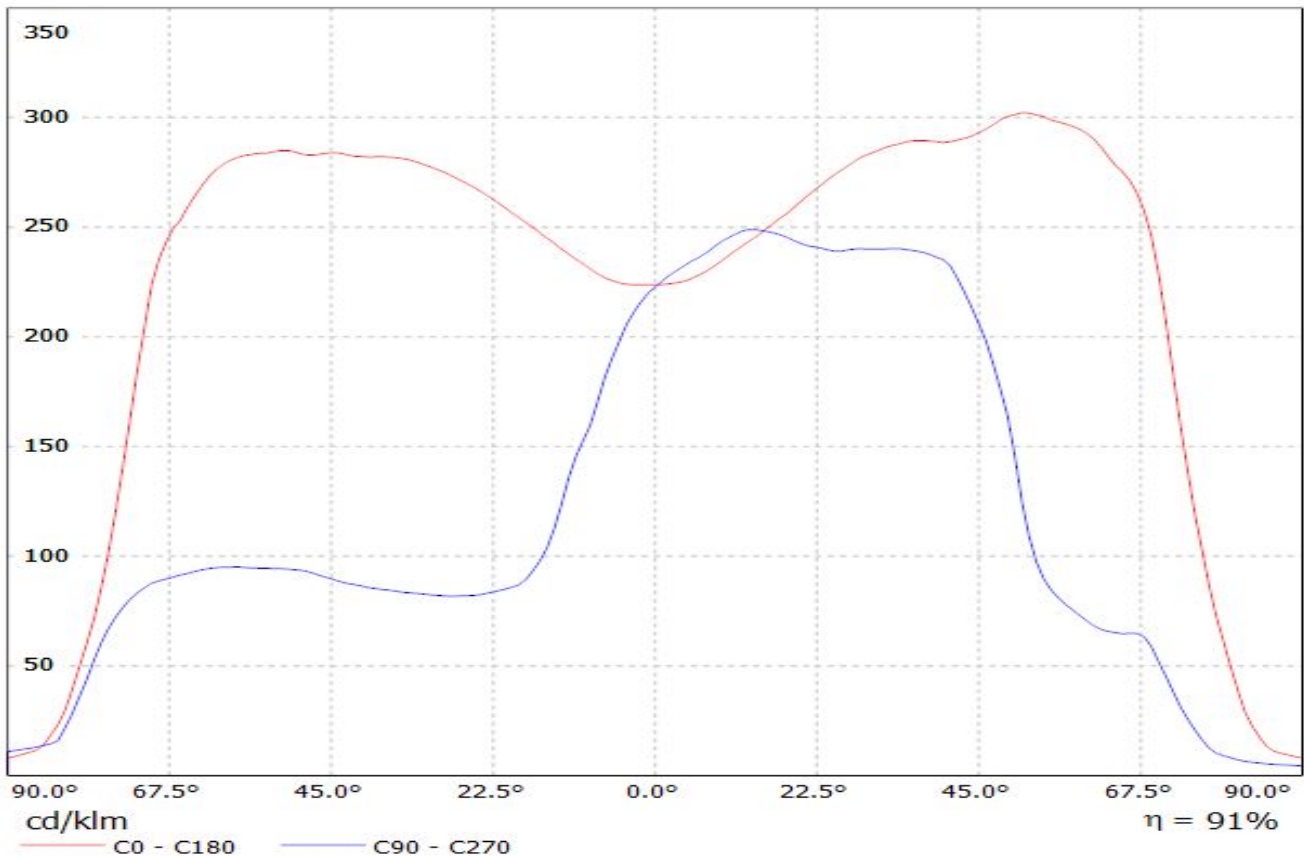

Ledil FN13323_STELLA-A_(CXA1850) / LDC (Linear)

Luminaire: Ledil FN13323_STELLA-A_(CXA1850)
Lamps: 1 x CREE_CXA1850_(CXA1850-30F-T4-N0Y-00001)
_837.004lm@250mA_CCT=3000K_P=8.24W_I=0.25A

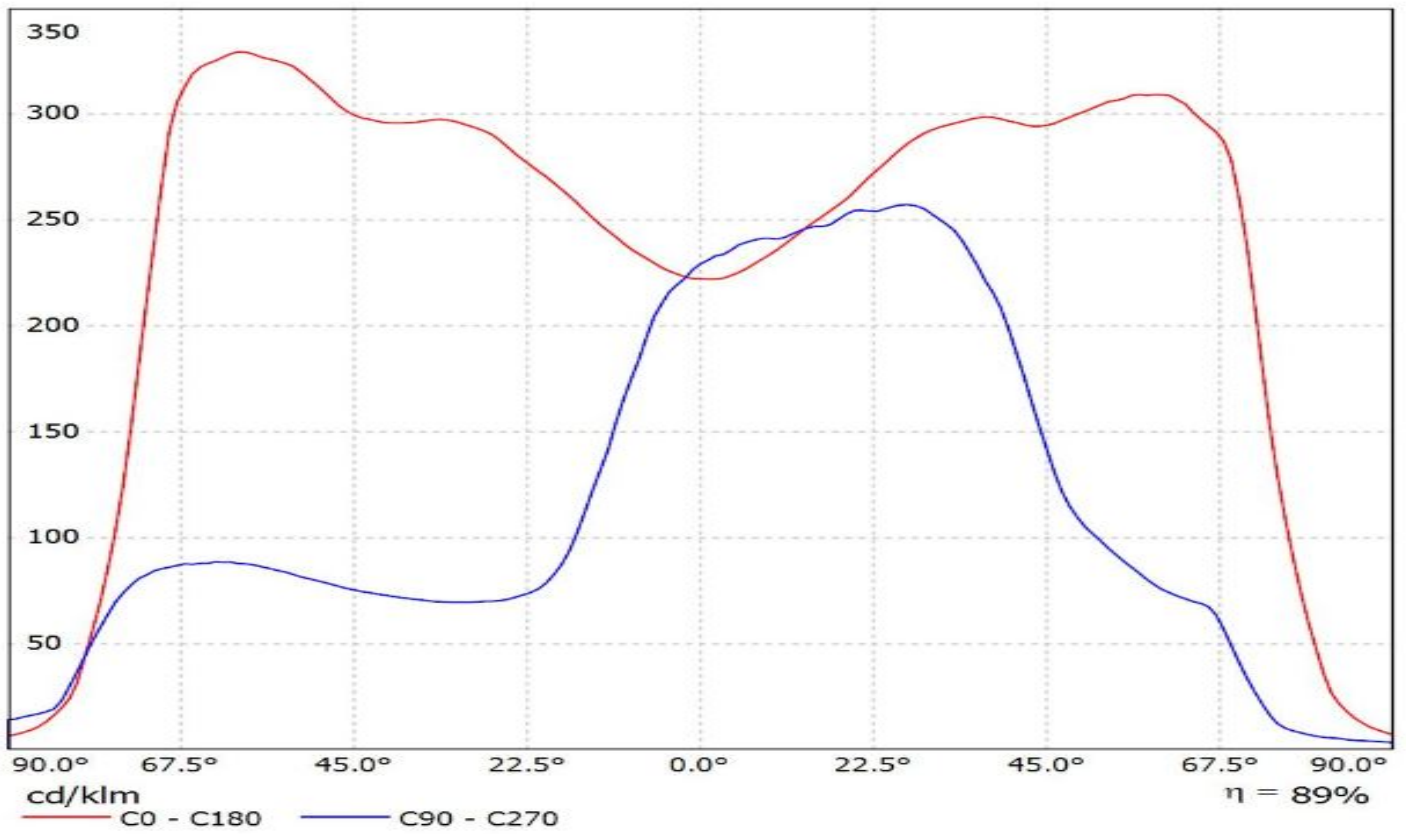

LEDiL Oy FN13323_STELLA-A_(CXA1816) Eff.87.1% / LDC (Linear)

Luminaire: LEDiL Oy FN13323_STELLA-A_(CXA1816) Eff.87.1%
Lamps: 1 x CREE_CXA1816_1075.33lm@250mA_P=8.66981W_I=249.8mA

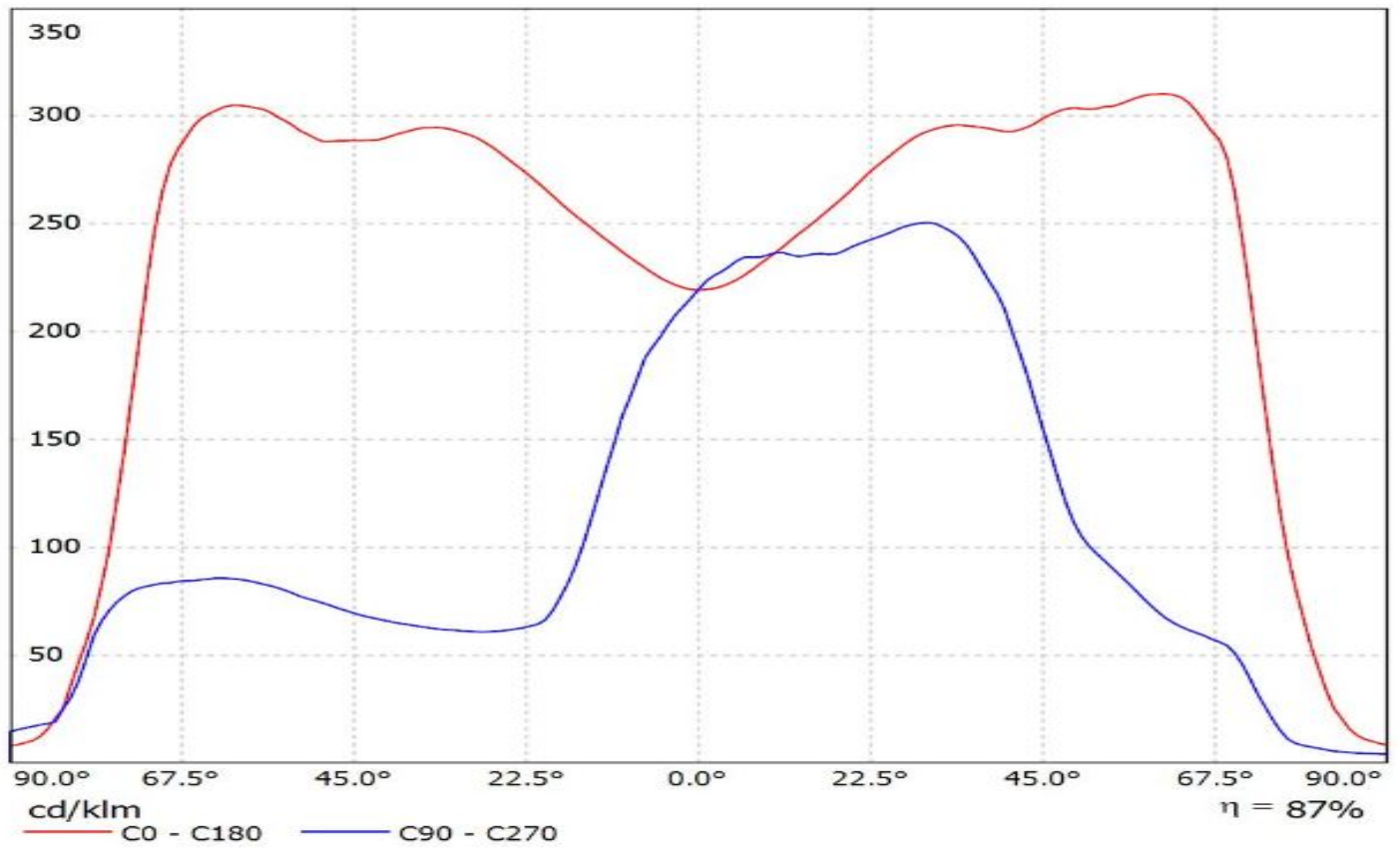

Luminaire: LEDiL Oy FN13323_STELLA-A_(SOLERIQ_S19)

Lamps: 1 x OSRAM_SOLERIQ_S19_(GW_KAHJB1.EM)_1340.3lm@250mA_CCT=3000K_P=10.4491W_I=249.8mA

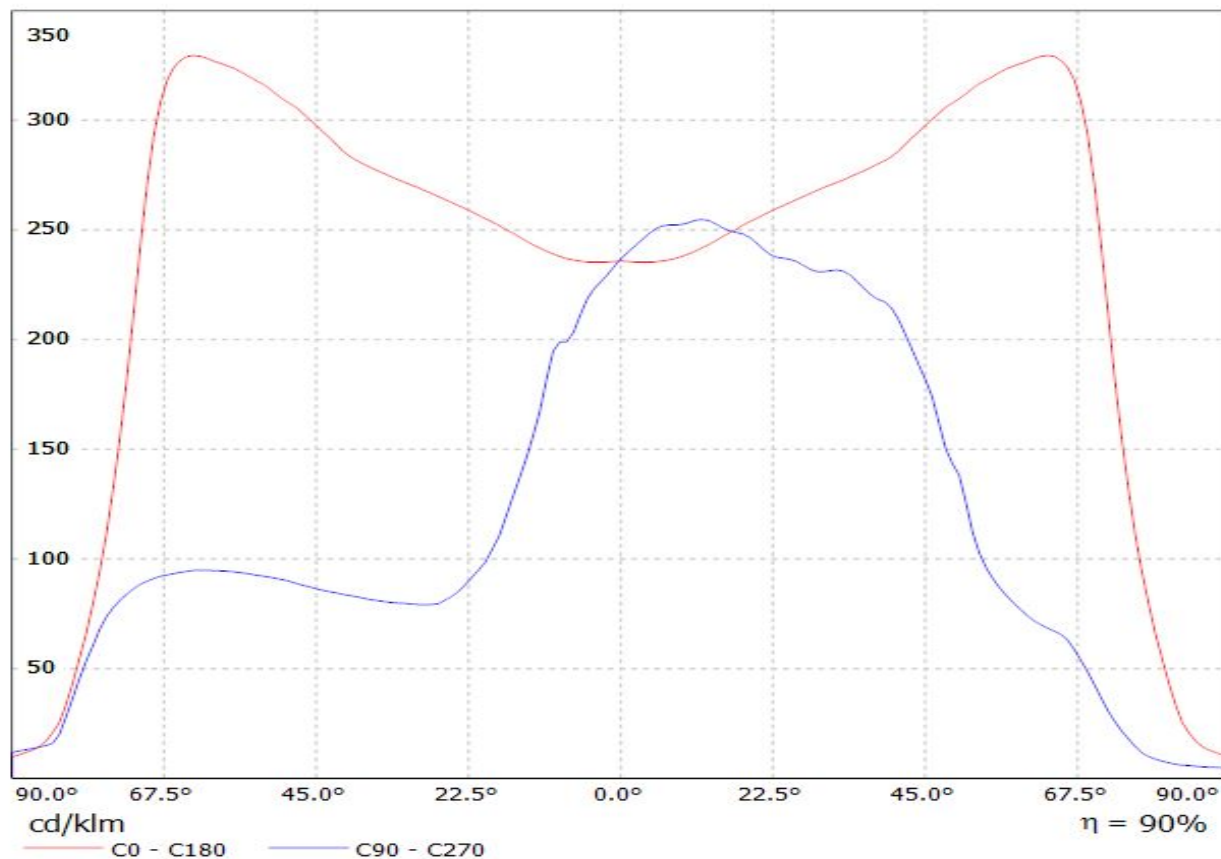

Luminaire: LEDiL Oy FN13323_STELLA-A (Megazenigata_GW6D) Eff.89.9%
Lamps: 1 x SHARP_Megazenigata_(GW6DMC40NFC)_1072.13lm@250mA_P=8.51443W_I=249.8mA

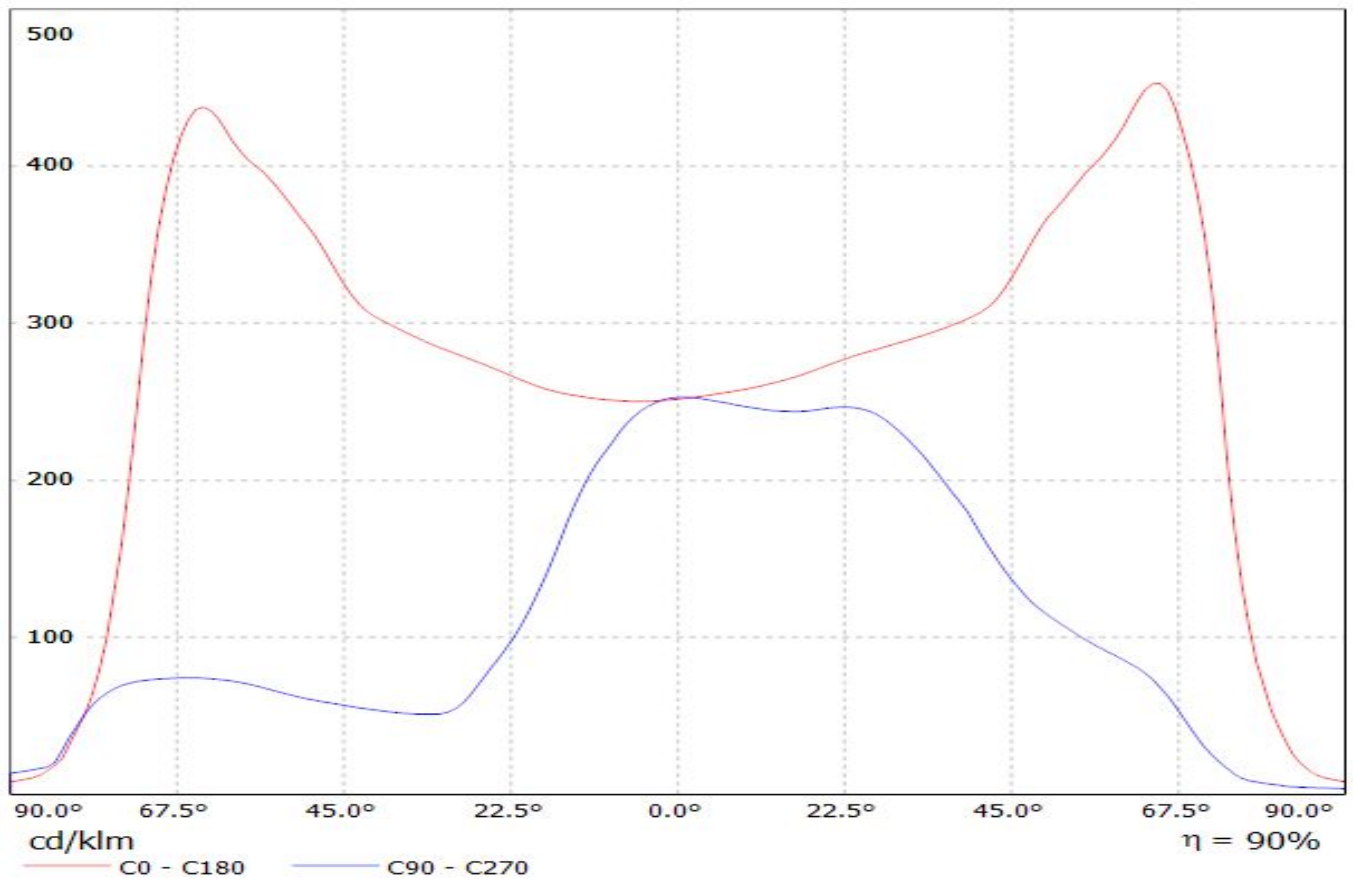

Ledil FN13323_STELLA-A_(NFCLL060B) / LDC (Linear)

Luminaire: Ledil FN13323_STELLA-A_(NFCLL060B)

Lamps: 1 x Nichia_NFCLL060B_(sm406G2450R8000)_1368.94lm@250mA_P=8.5W_I=0.25A

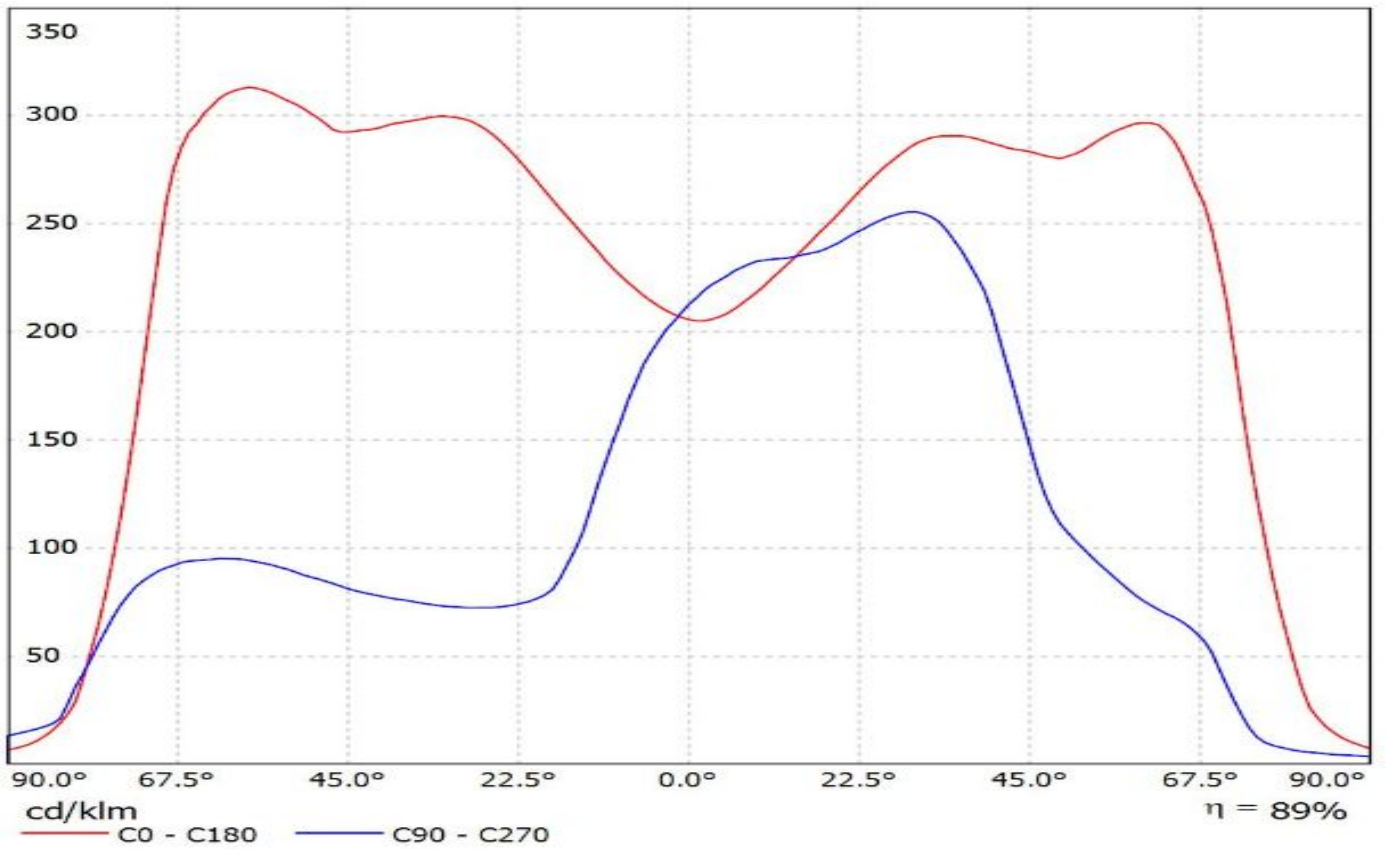

Luminaire: Ledil FN13323_STELLA-A_(Soleriq_P9)

Lamps: 1 x Osram_Soleriq_P9_(GW_MAFJB1.EM)_976.011lm@250mA_CCT=4299K_P=6.9W_I=0.25A

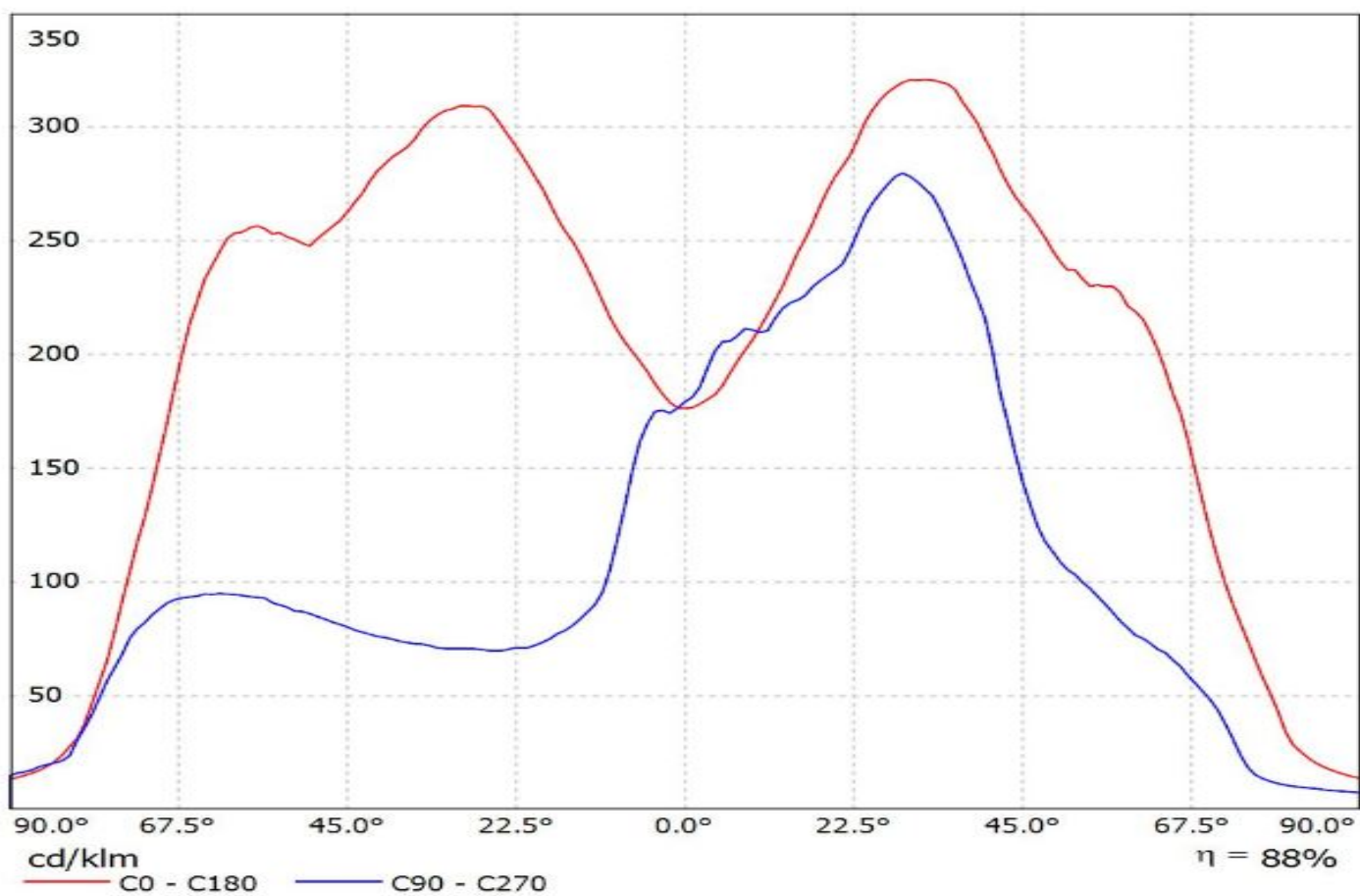

Luminaire: LEDiL Oy FN13323_STELLA-A (Luxeon_CoB_1203)_ (438_Typ_L1)

Lamps: 1 x Luxeon_CoB_1203_(LHC1-3080-1203)_ (438_Typ_L1)_ 1005.18lm@250mA_P=8.69829W_I=0.2498A

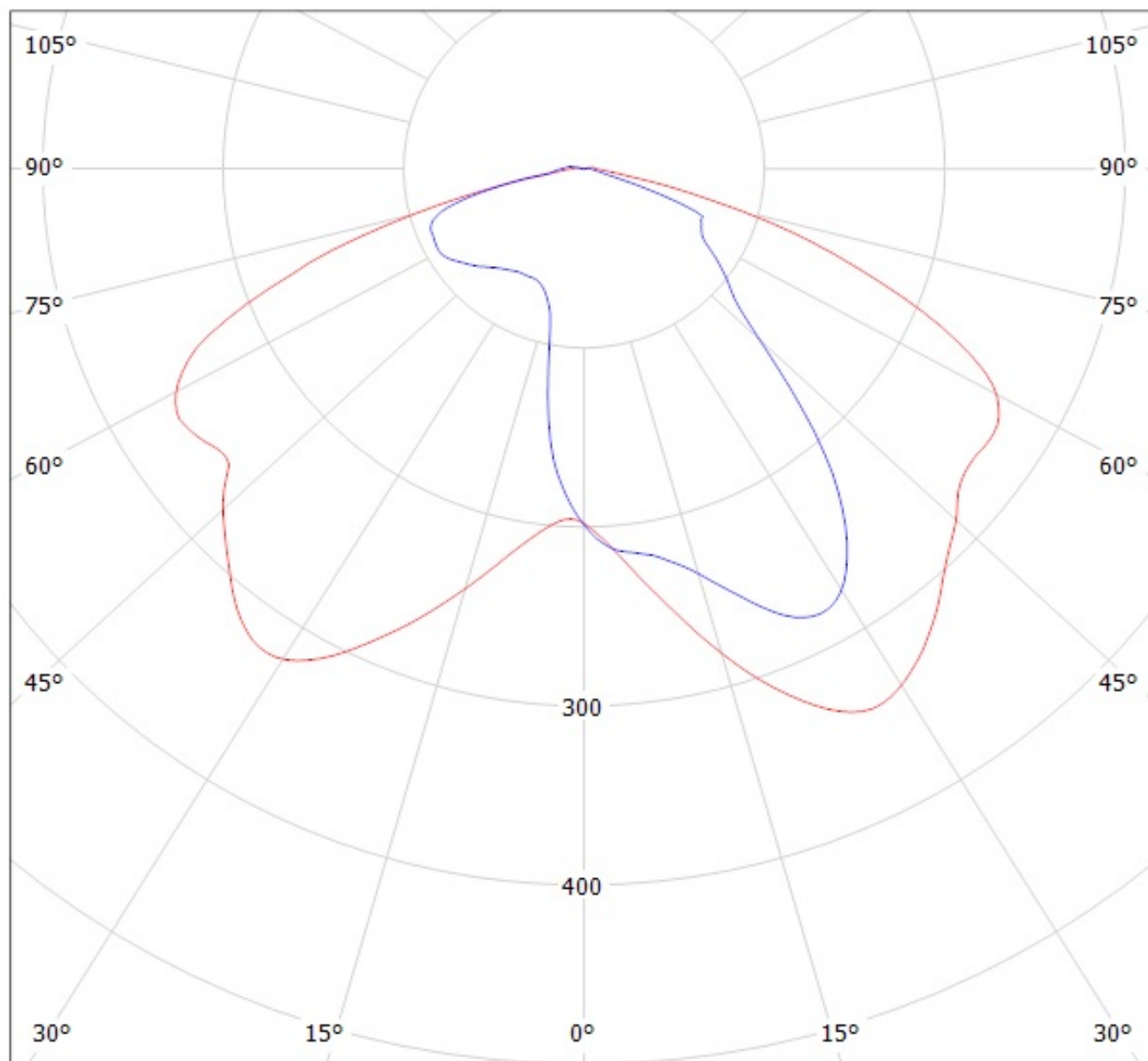

cd/klm

— C0 - C180

— C90 - C270

$\eta = 88\%$

Ledil FN13323_STELLA-A_(NFCLL036B) / LDC (Polar)

Luminaire: Ledil FN13323_STELLA-A_(NFCLL036B)
Lamps: 1 x Nichia_NFCLL036B_(SM403J1300R8000)
_563.488lm@100mA_CCT=4000K_P=3.35W_I=0.100A

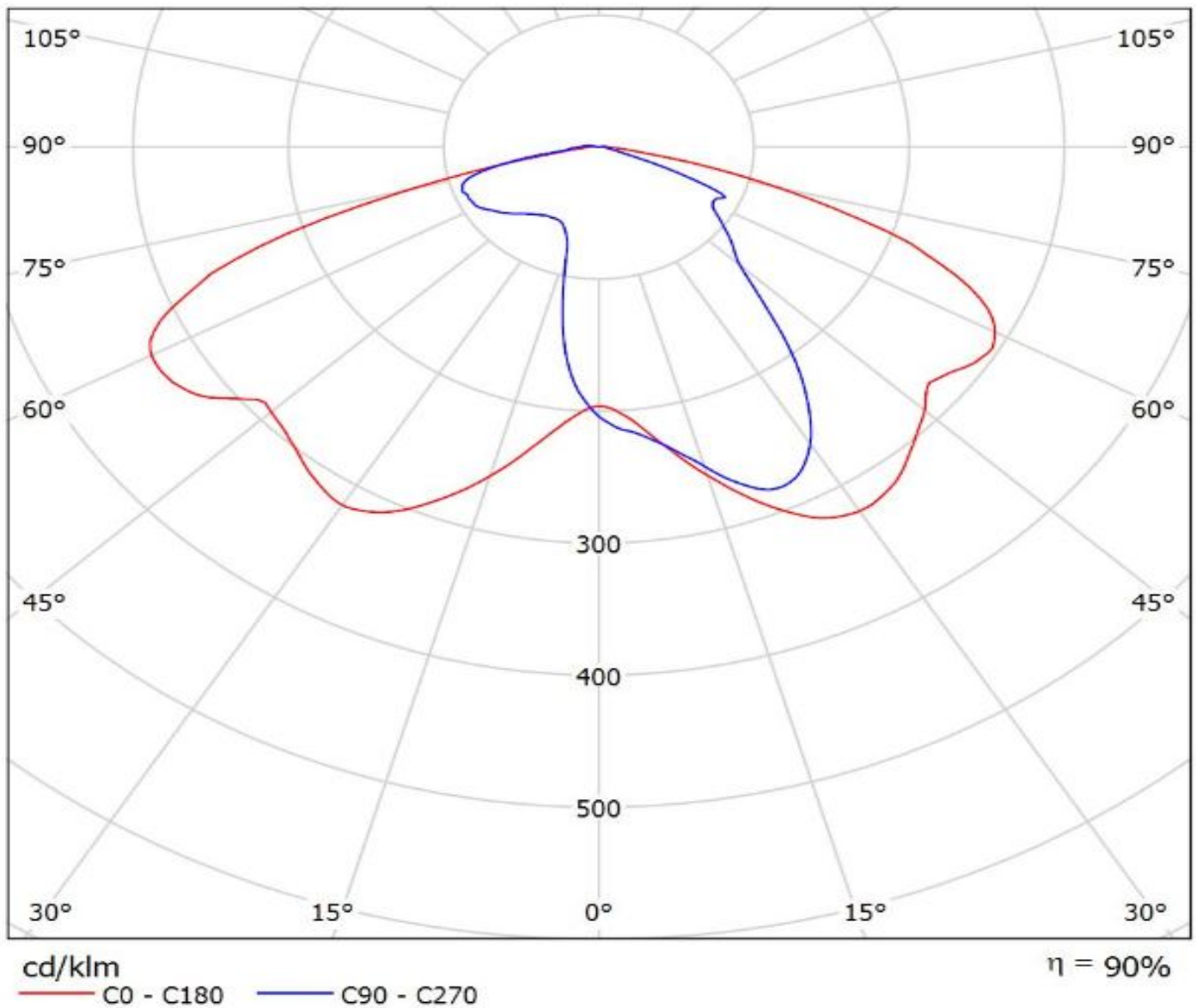

Luminaire: LEDiL Oy FN13323_STELLA-A_(CXM-18) Eff.89.2%
Lamps: 1 x LUMINUS_XNOVA_CXM-18_897.842lm@250mA_P=8.12425W_I=249.9mA

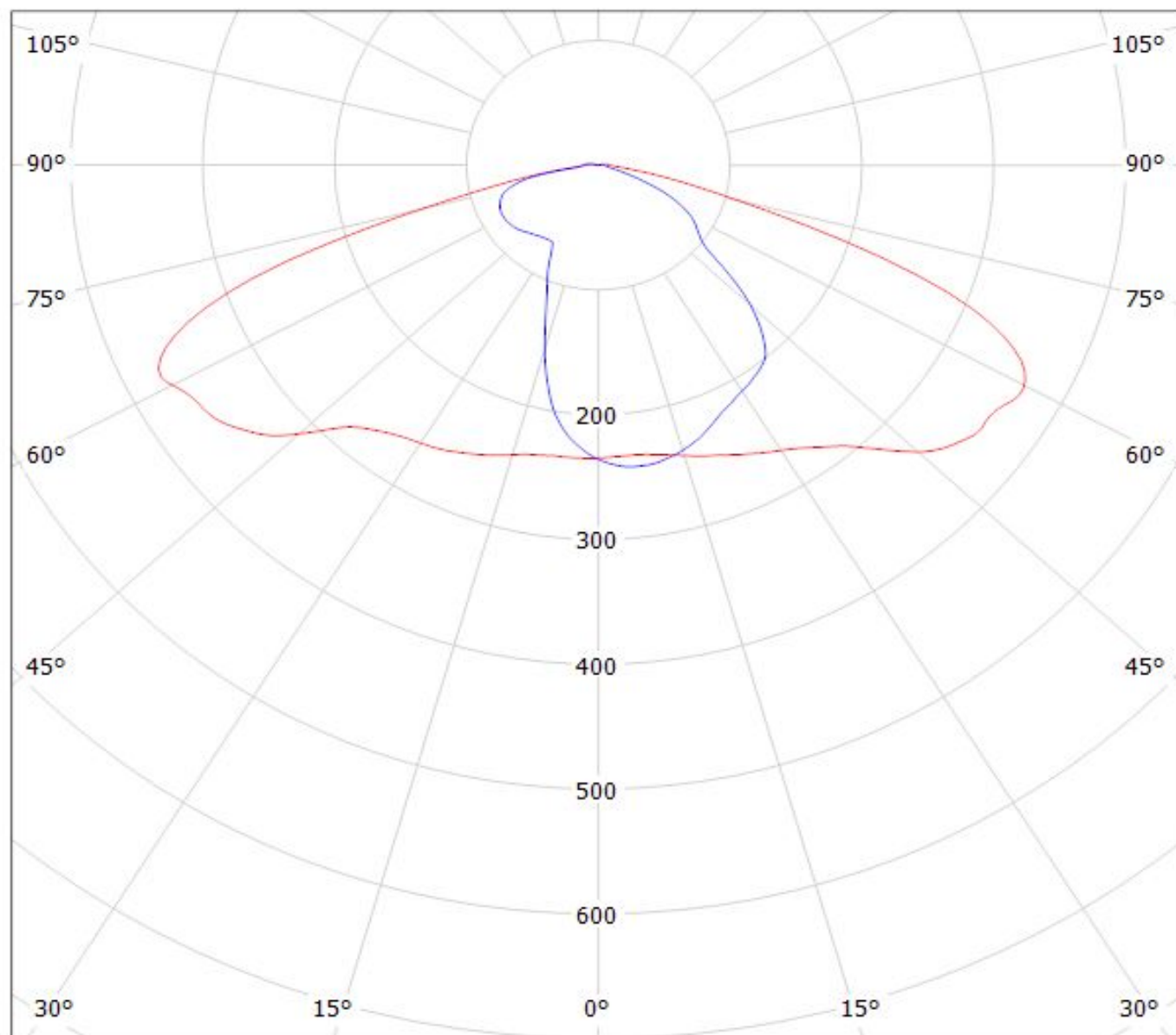

cd/klm

— C0 - C180 — C90 - C270

η = 89%

Luminaire: LEDiL Oy FN13323_STELLA-A_(V15)

Lamps: 1 x Bridgelux_V15_1050.21lm@250mA_P=8.19169W_I=249.8mA

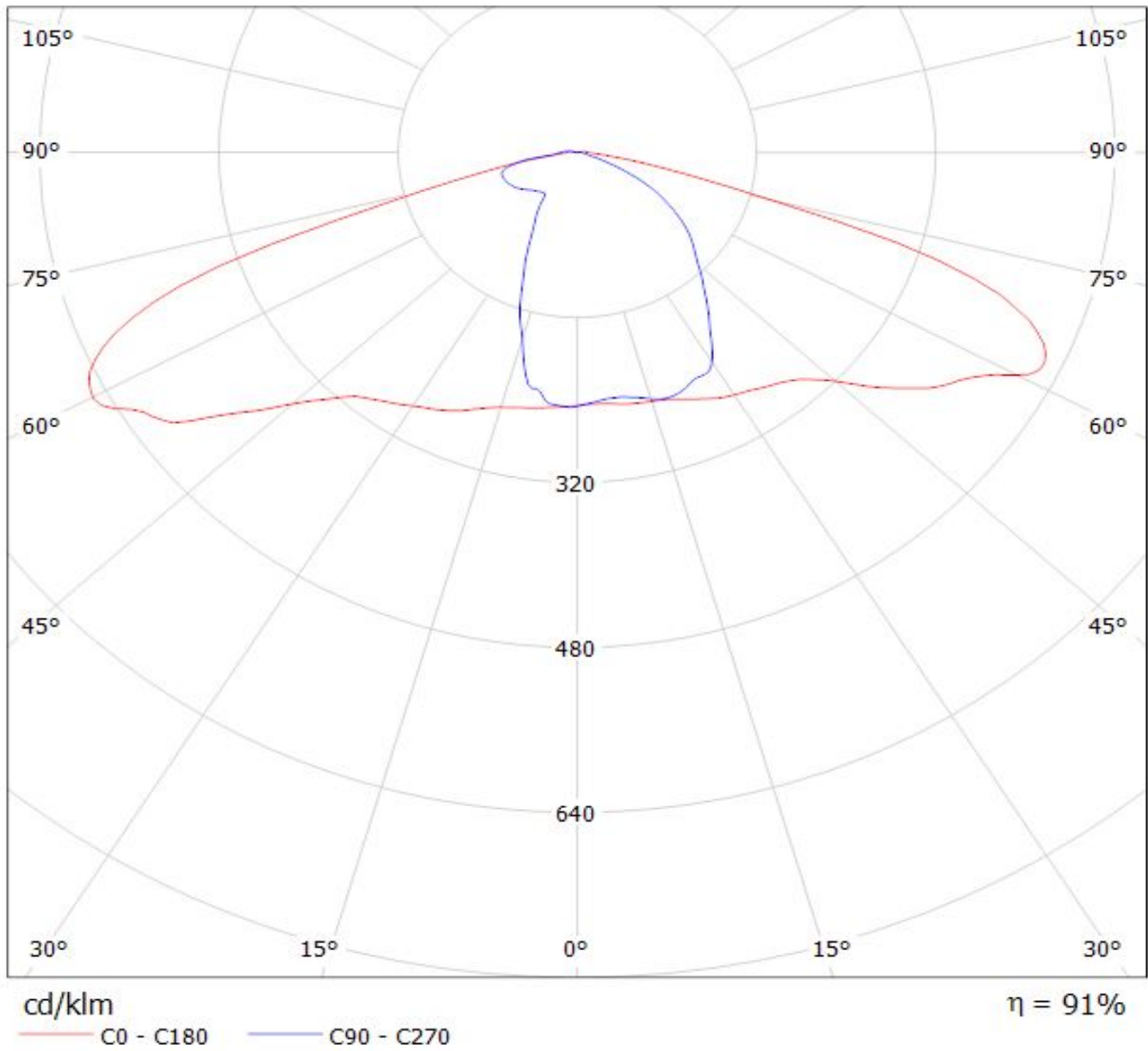

Luminaire: LEDiL Oy FN13323_STELLA-A_(SOLERIQ_P13)

Lamps: 1 x SOLERIQ_P13_(GW_MAGMB1.EM)_929.576lm@250mA_CCT=3500K_P=8.72876W_I=249.8mA

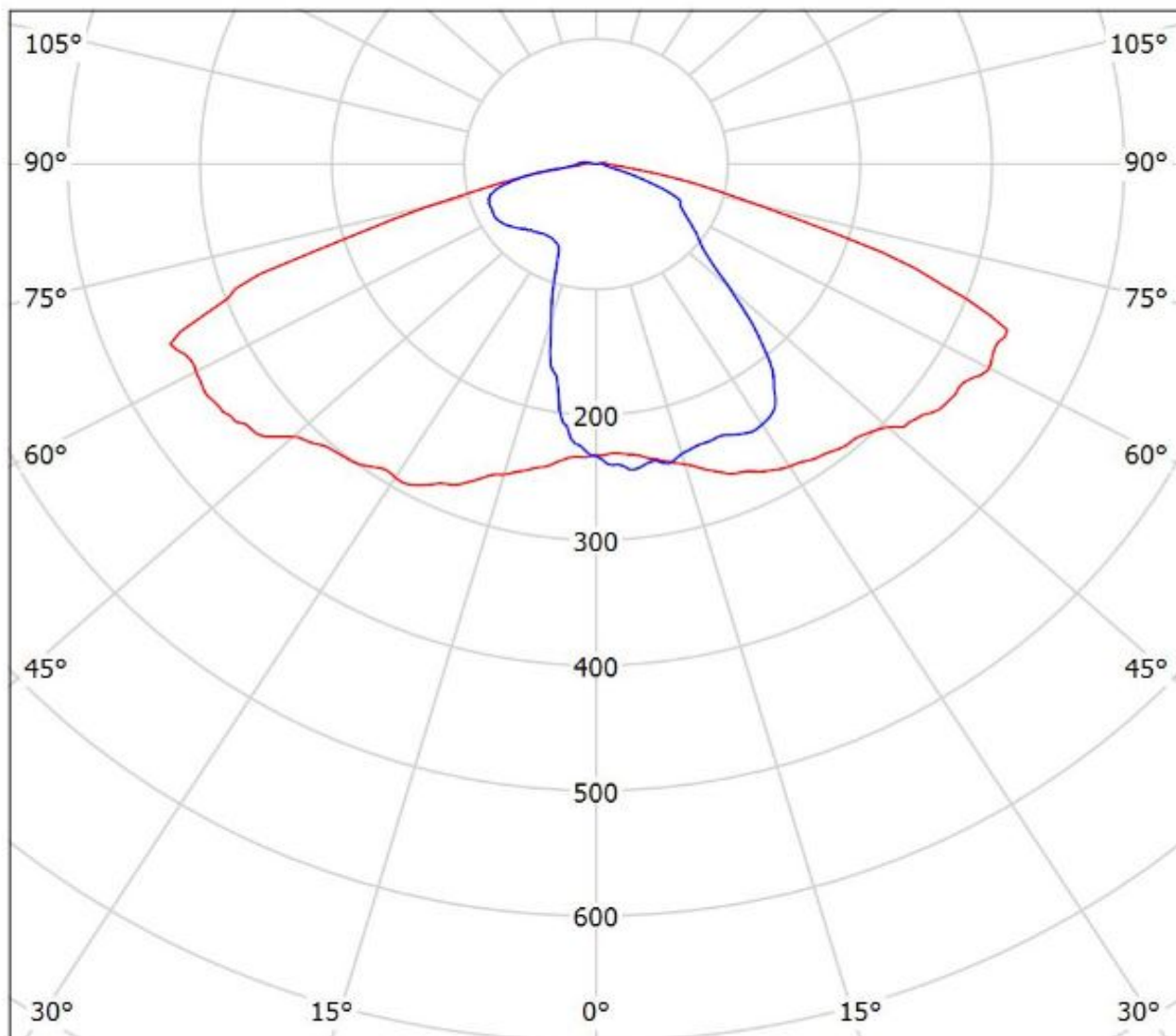

cd/klm

— C0 - C180 — C90 - C270

$\eta = 90\%$

Luminaire: LEDiL Oy FN13323_STELLA-A_(CXA25) Eff. 93%

Lamps: 1 x CREE_CXA25 (CXA2530-7C0-T2-N0H)1100lm@250mA CCT=3000K P=8W I=250mA

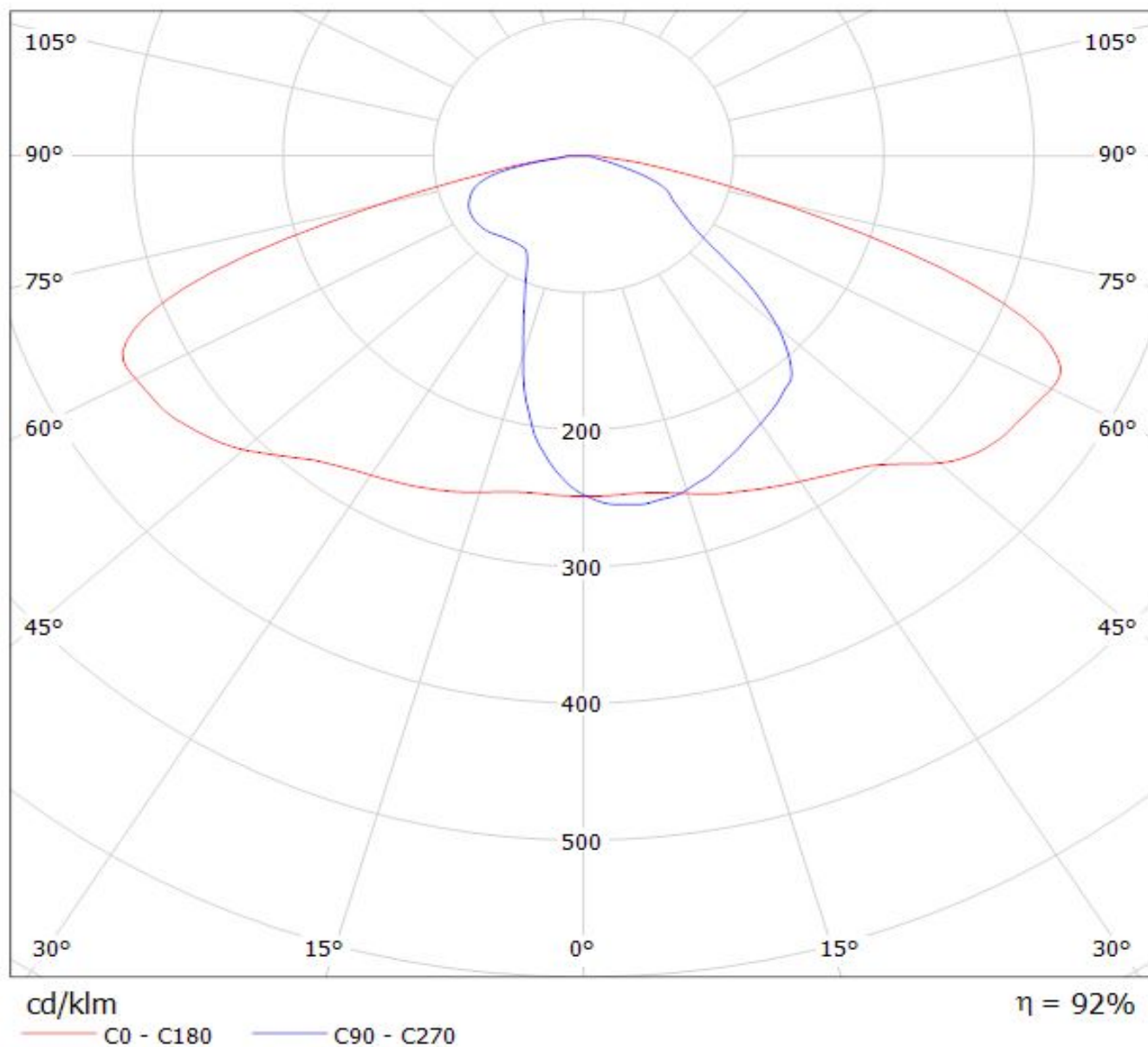

Luminaire: LEDiL Oy FN13323_STELLA-A_(CXA1507) Eff: 92%

Lamps: 1 x Cree_CXA1507_(CXA1507-30F-F2-N0A-0000) 220lm@50mA CCT=3000K P=2W I=50mA

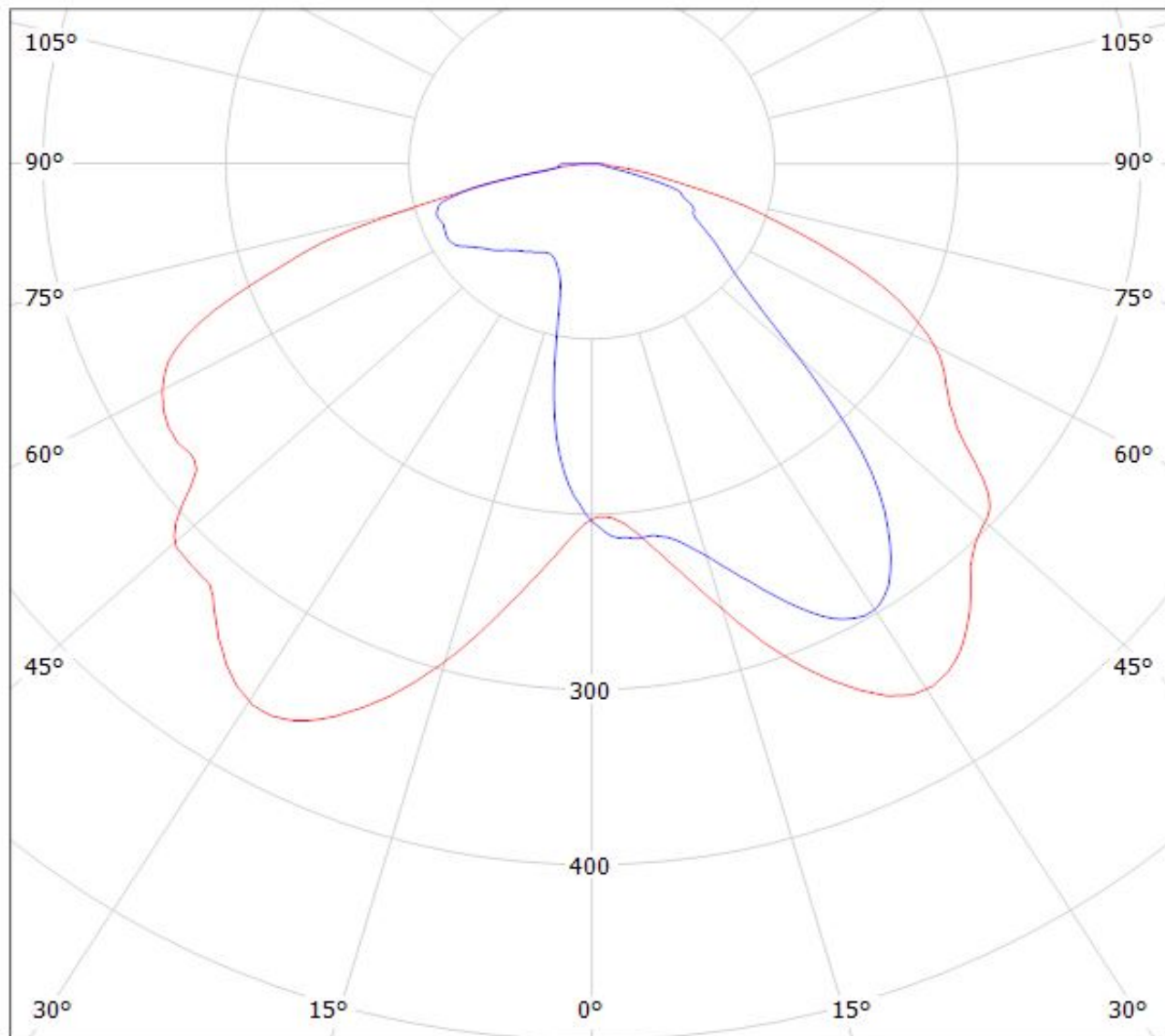

cd/klm

— C0 - C180

— C90 - C270

$\eta = 91\%$

Luminaire: LEDiL Oy FN13323_STELLA-A_(Soleriq_S13)

Lamps: 1 x Osram_Soleriq_S13_802.964lm@250mA_CCT=3125K_P=7.26069W_I=249.8mA

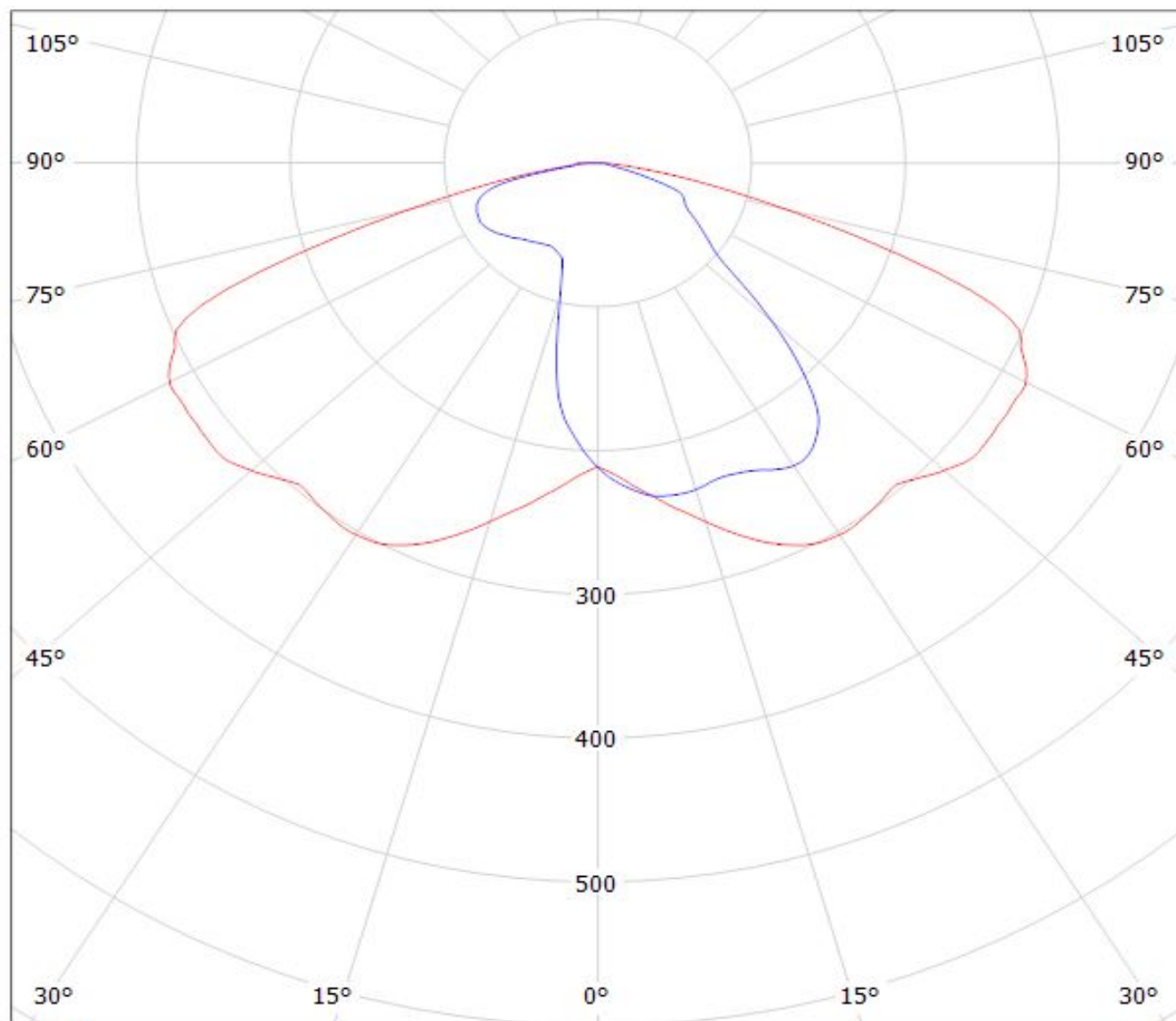

cd/klm

— C0 - C180

— C90 - C270

$\eta = 91\%$

Luminaire: Ledil FN13323_STELLA-A_(CLU710)

Lamps: 1 x CITIZEN_CLU710_(CLU710-1204B8-273M2G1)_1212.66lm@250mA_P=8.5W_I=0.25A

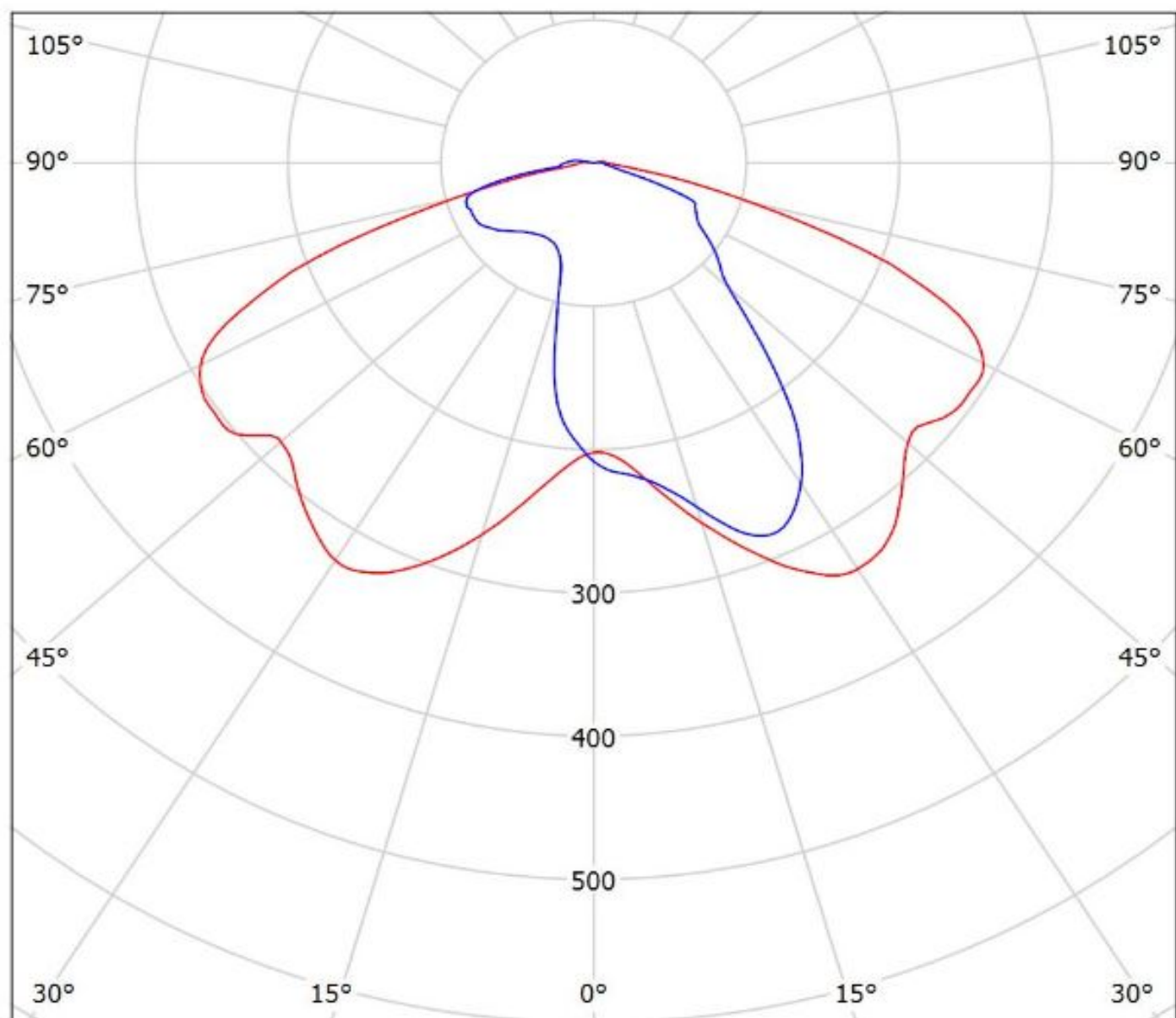

cd/klm

— C0 - C180 — C90 - C270

$\eta = 89\%$

Ledil FN13323_STELLA-A_(CLU720) / LDC (Polar)

Luminaire: Ledil FN13323_STELLA-A_(CLU720)
Lamps: 1 x CITIZEN_CLU720_(CLU720-1206B8-273M2)
_1298.17lm@250mA_CCT=2700K_P=8.3W_I=0.25A

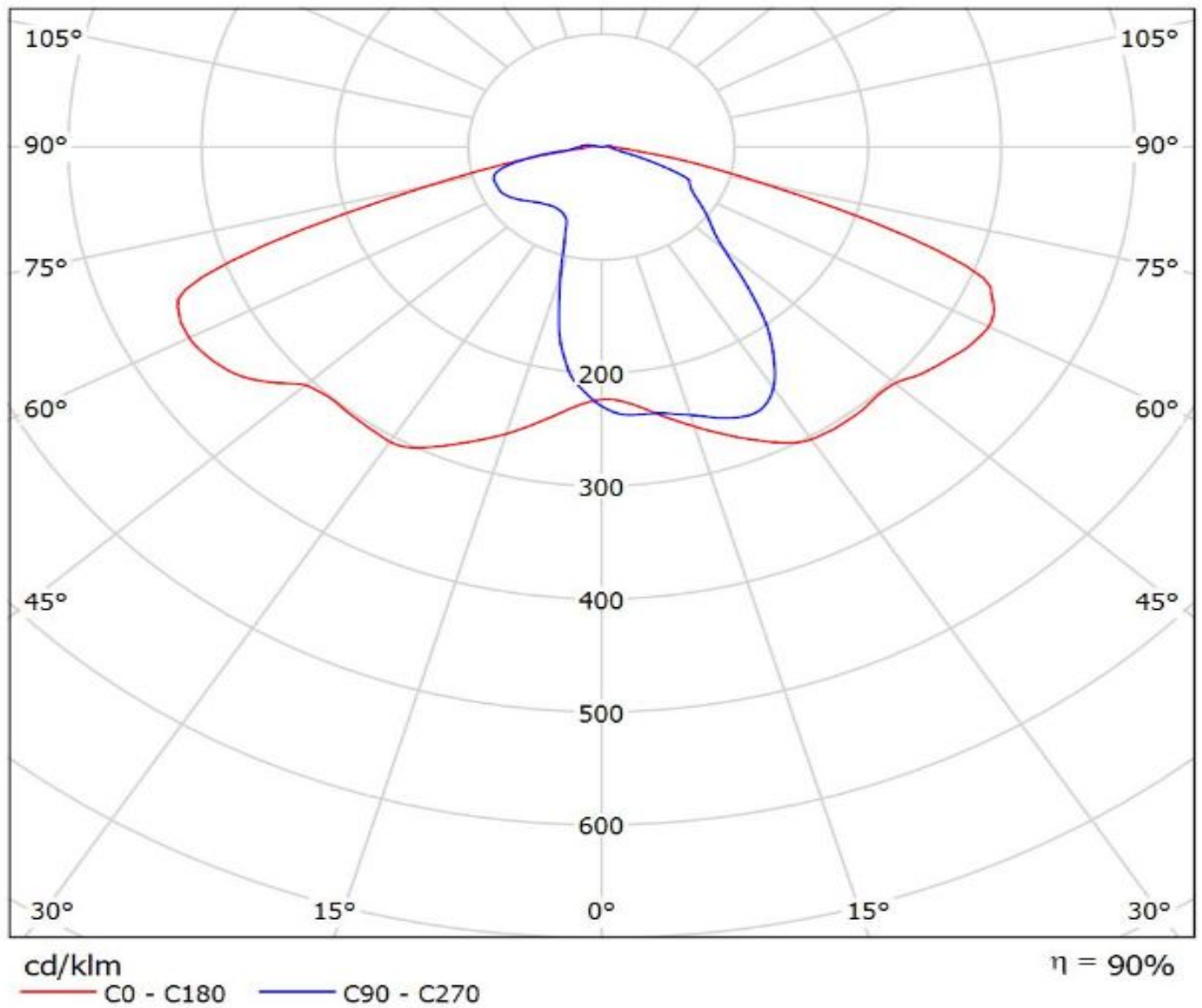

Luminaire: LEDiL Oy FN13323_STELLA-A Eff. 92%

Lamps: 1 x VERO13 (BXRC-30E4000F) 819lm@250mA CCT=3000K P=7.5W I=250mA

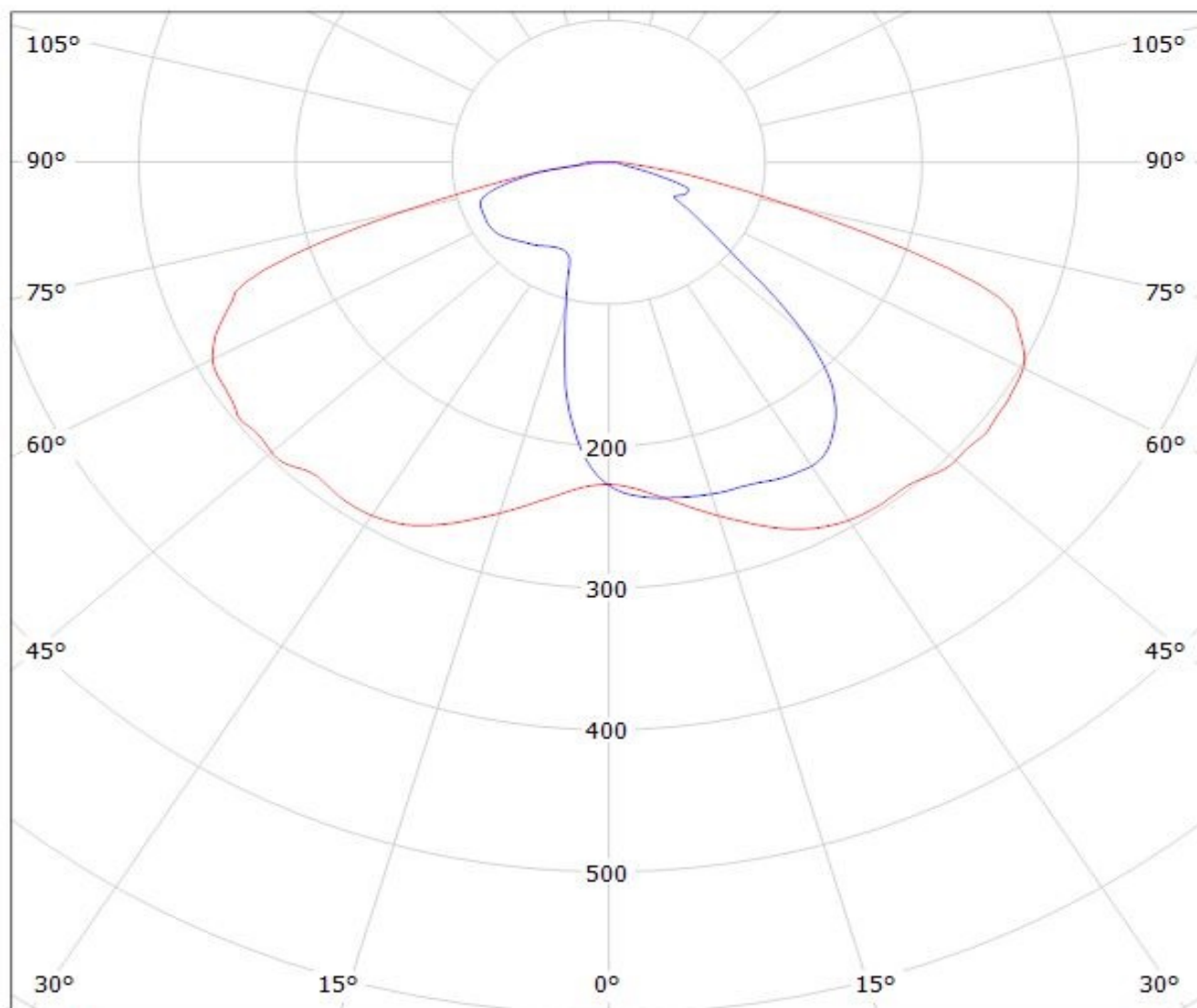

cd/klm

— C0 - C180

— C90 - C270

Luminaire: LEDiL Oy FN13323_STELLA-A (VERO18) Eff. 92%

Lamps: 1 x VERO18 (BXRC-30E4000F)786lm@250mA CCT=3000K P=6.84W I=250mA

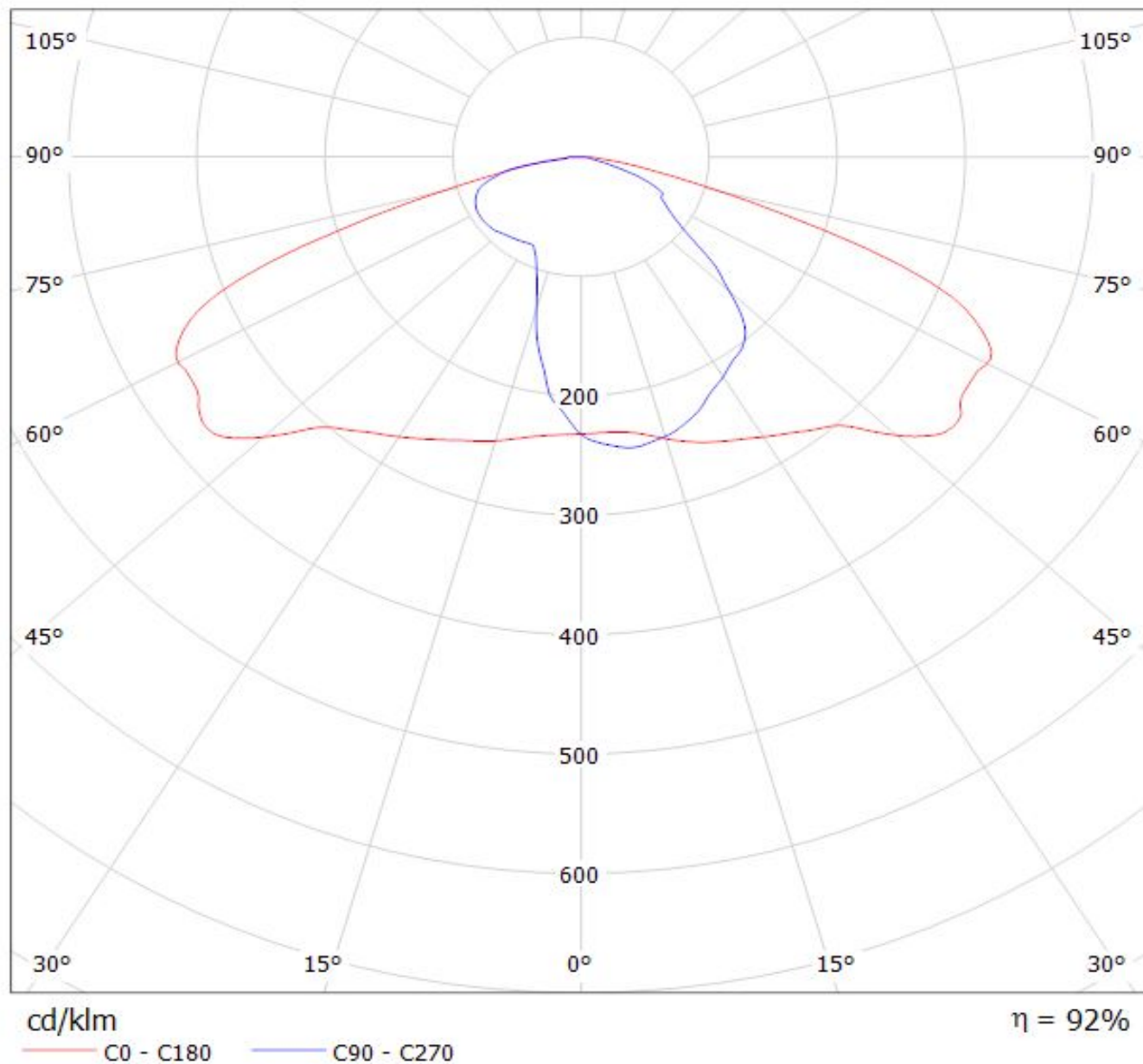

Ledil FN13323_STELLA-A_(P13) / LDC (Polar)

Luminaire: Ledil FN13323_STELLA-A_(P13)
Lamps: 1 x Osram Soleriq P13 (GW MAGMB1.EM)
_929.576lm@250mA_CCT=3500K_P=8.72876W_I=249.8mA

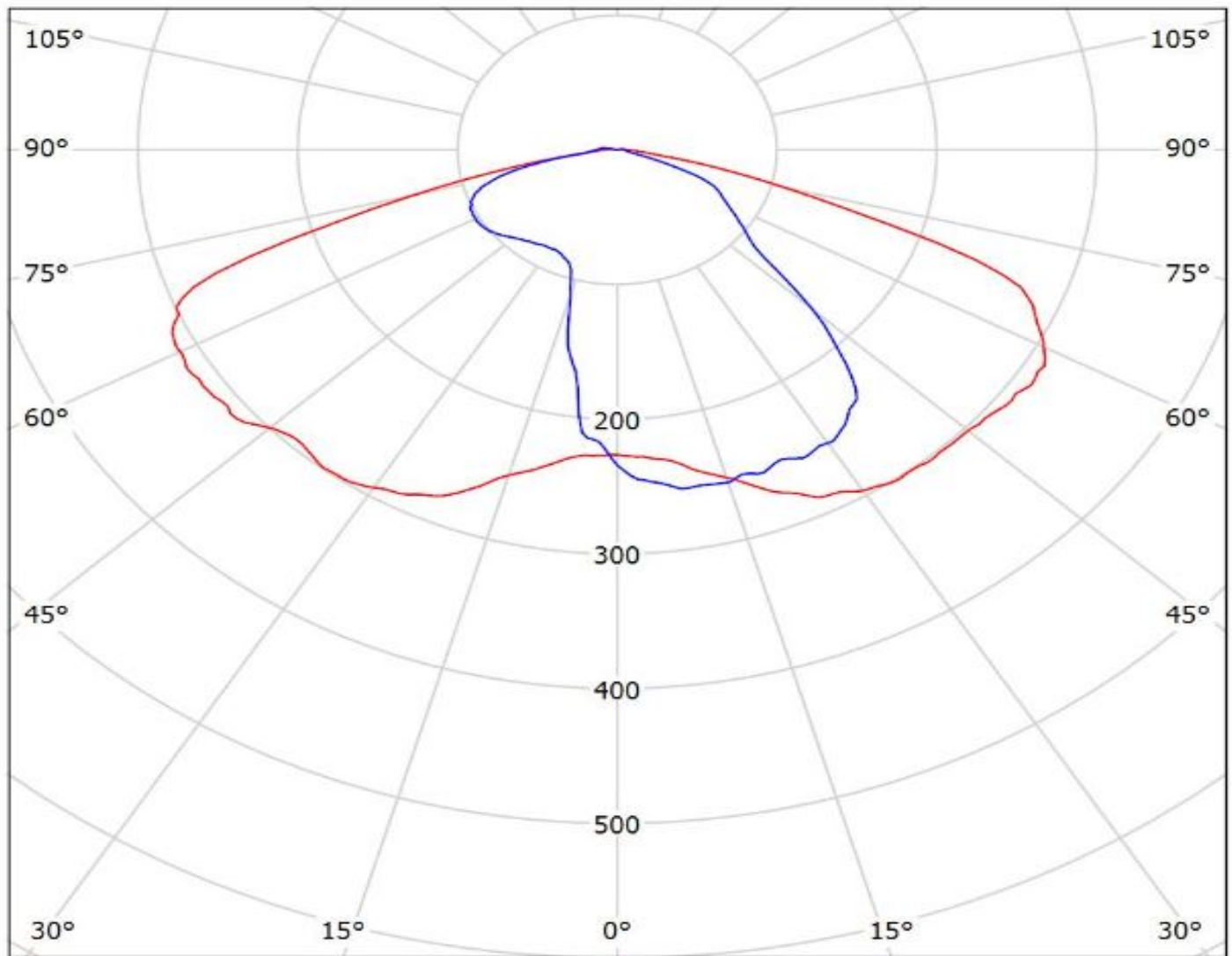

cd/klm
— C0 - C180 — C90 - C270

$\eta = 94\%$

Ledil FN13323_STELLA-A_(Soleriq_S13) / LDC (Polar)

Luminaire: Ledil FN13323_STELLA-A_(Soleriq_S13)

Lamps: 1 x Osram_Soleriq_S13_(GW_KAGHB1.EM)_875.214lm@250mA_P=7.44679W_I=250mA

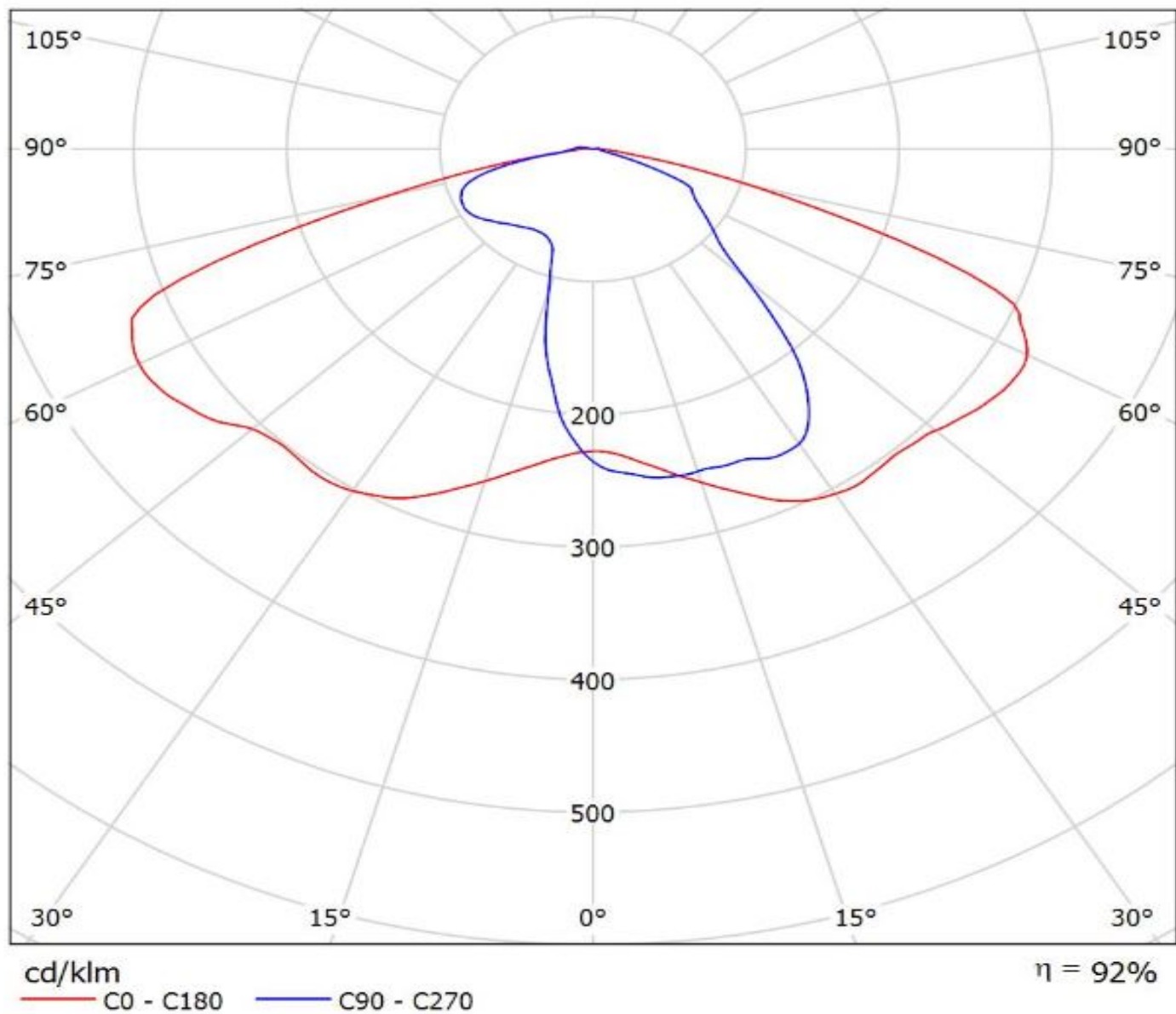

Luminaire: LEDiL Oy FN13323_STELLA-A_(CXM-14)
Lamps: 1 x LUMINUS_XNOVA_CXM-14_(AC00)
_1064.17lm@250mA_CCT=3133K_P=8.33558W_I=249.8mA

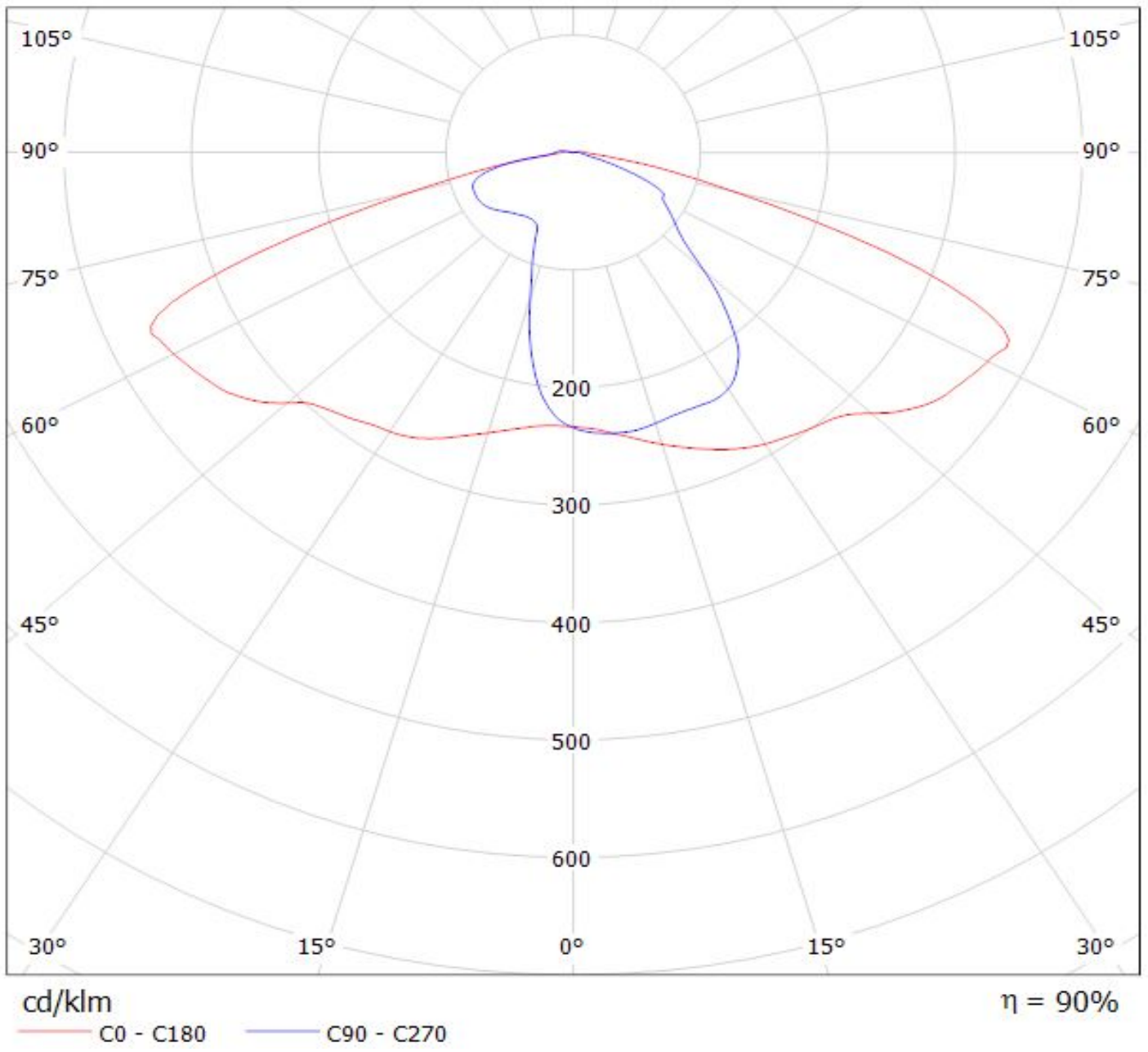

Luminaire: LEDiL Oy FN13323_STELLA-A_(CLL030) Eff. 92%

Lamps: 1 x Citizen_CLL030_(CLL030-1205A5-303H1A7) 690lm@250mA CCT=3000K P=9W I=250mA

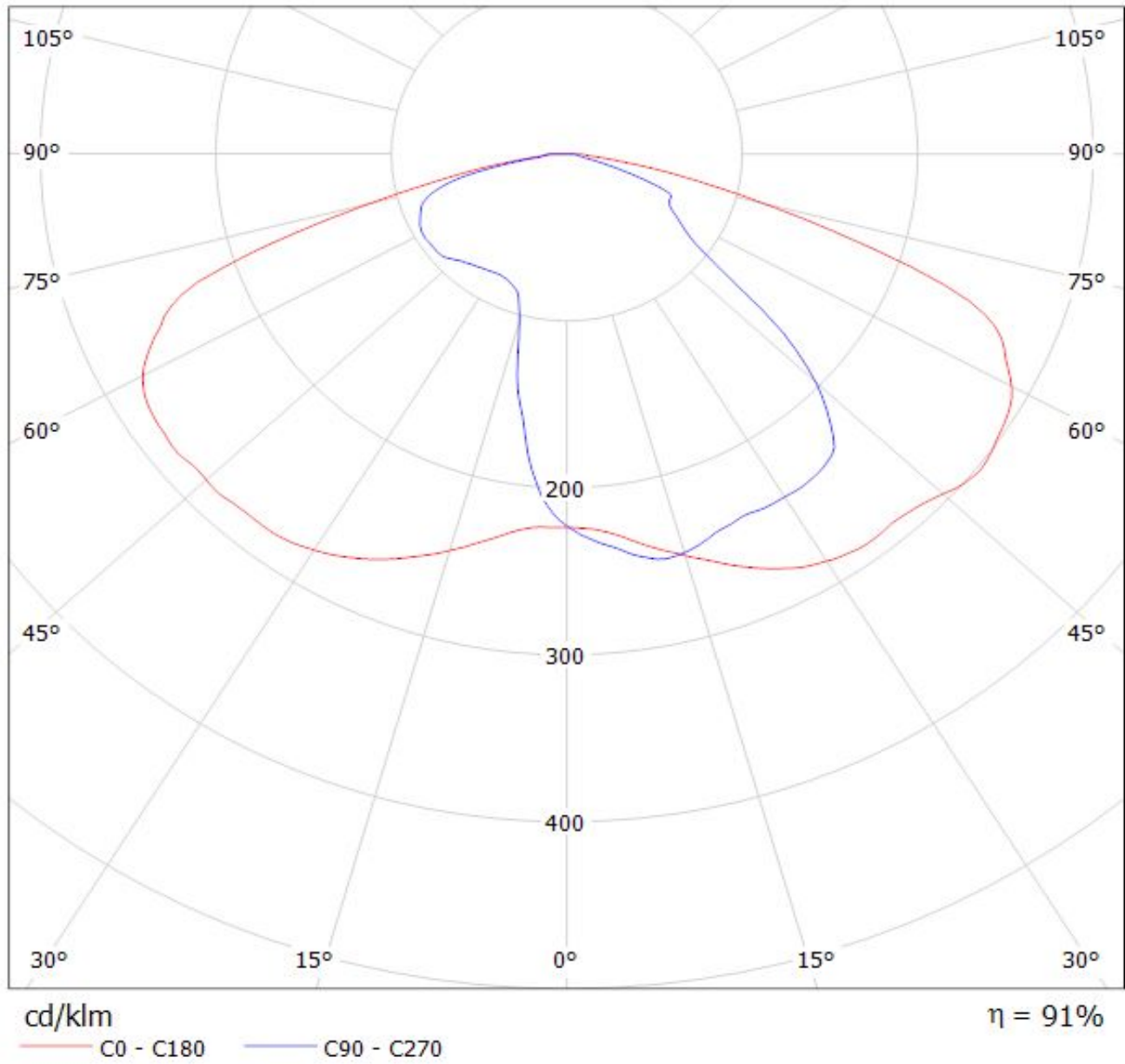

Ledil FN13323_STELLA-A_(CXA1850) / LDC (Polar)

Luminaire: Ledil FN13323_STELLA-A_(CXA1850)
Lamps: 1 x CREE_CXA1850_(CXA1850-30F-T4-N0Y-00001)
_837.004lm@250mA_CCT=3000K_P=8.24W_I=0.25A

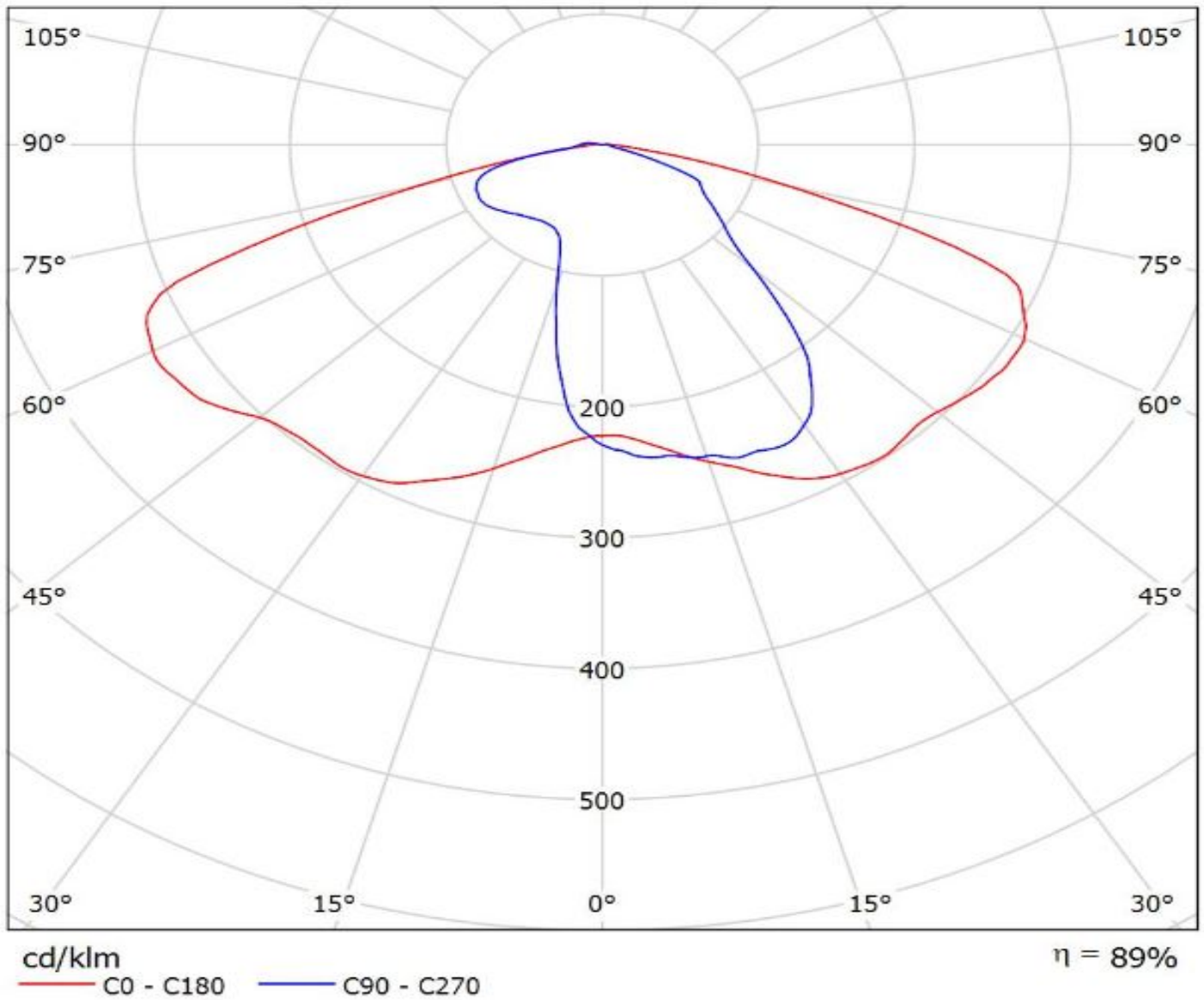

LEDiL Oy FN13323_STELLA-A_(CXA1816) Eff.87.1% / LDC (Polar)

Luminaire: LEDiL Oy FN13323_STELLA-A_(CXA1816) Eff.87.1%

Lamps: 1 x CREE_CXA1816_1075.33lm@250mA_P=8.66981W_I=249.8mA

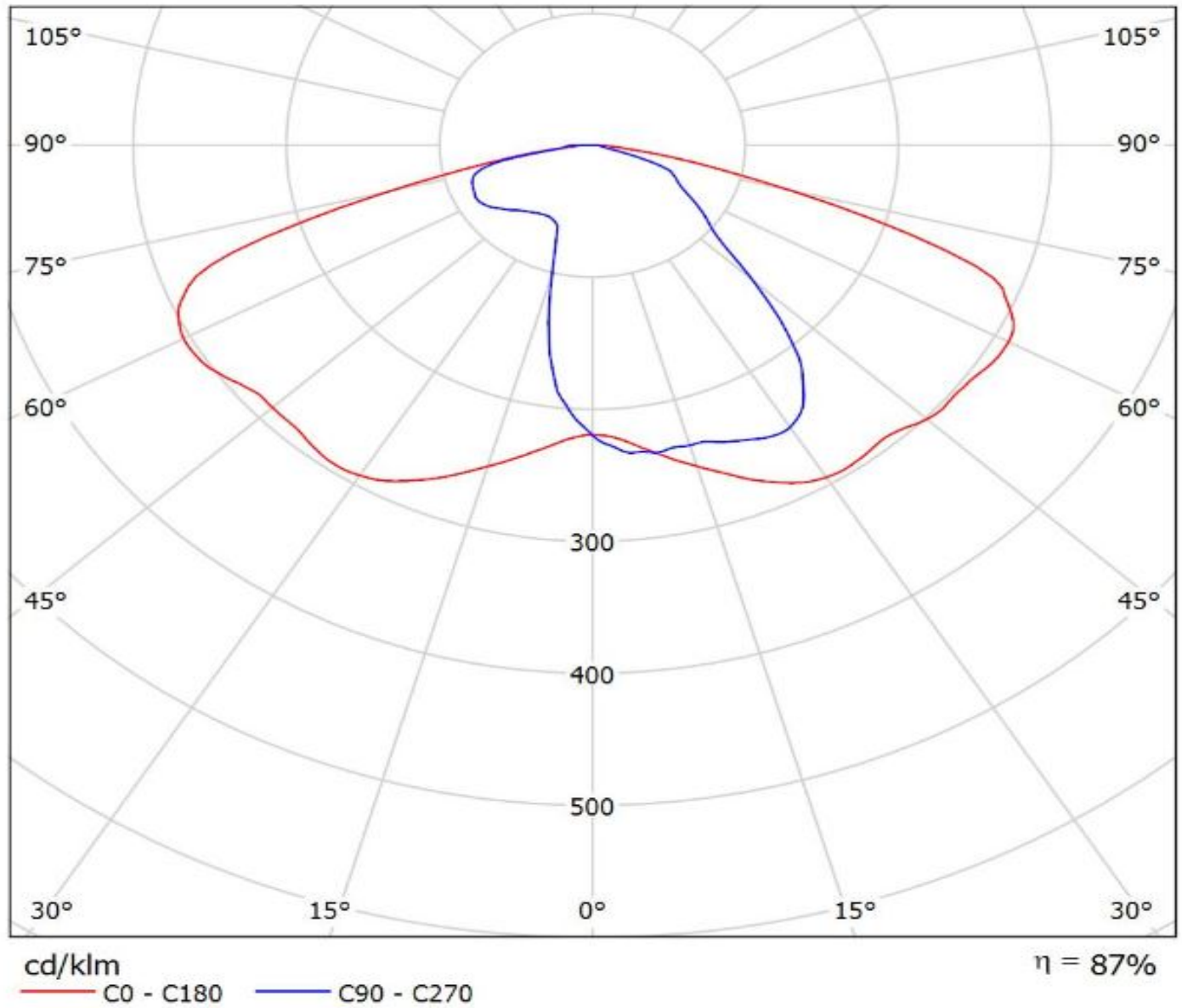

Luminaire: LEDiL Oy FN13323_STELLA-A_(SOLERIQ_S19)

Lamps: 1 x OSRAM_SOLERIQ_S19_(GW_KAHJB1.EM)_1340.3lm@250mA_CCT=3000K_P=10.4491W_I=249.8mA

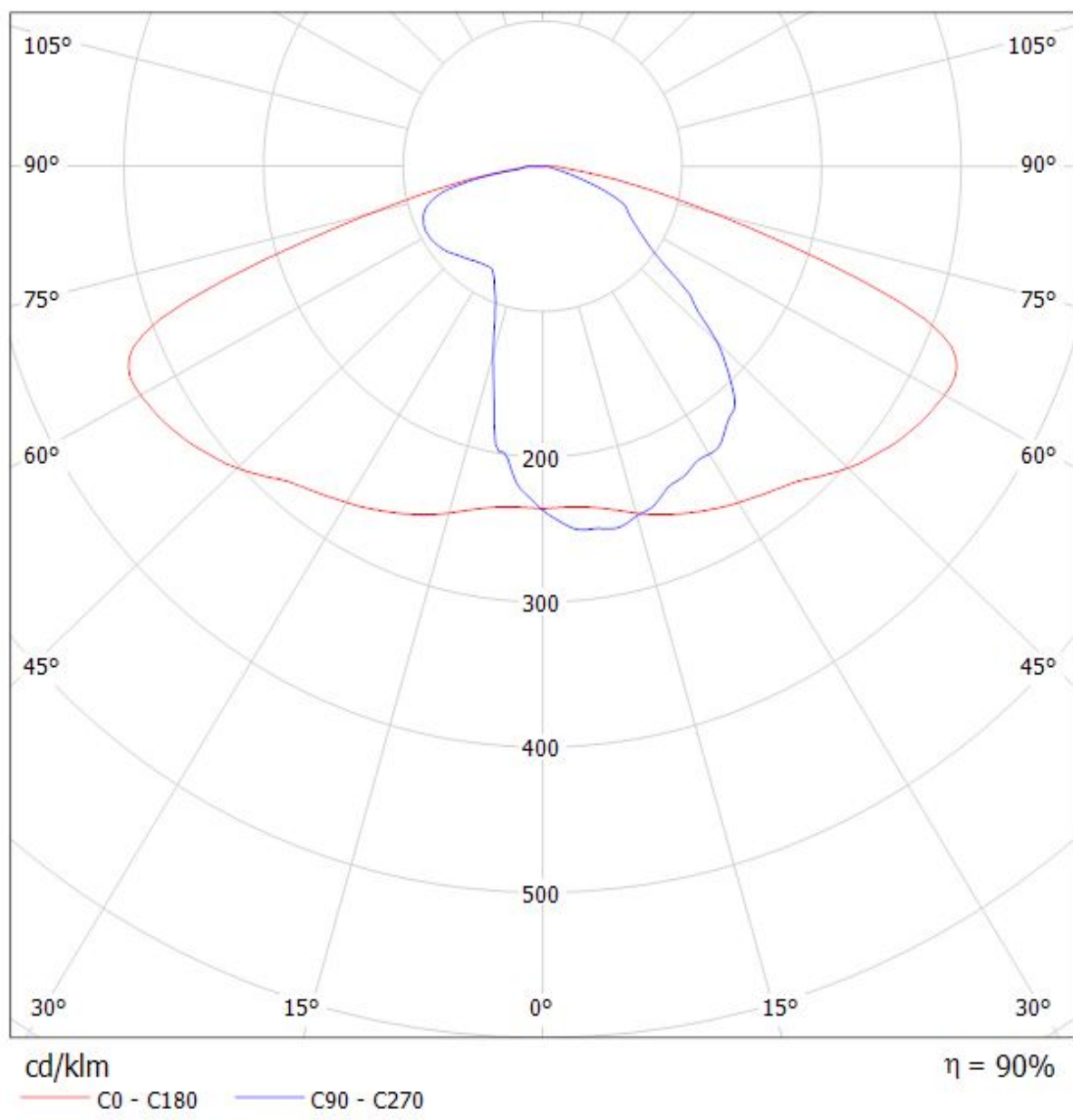

Luminaire: LEDiL Oy FN13323_STELLA-A_(Megazenigata_GW6D) Eff.89.9%

Lamps: 1 x SHARP_Megazenigata_(GW6DMC40NFC)_1072.13lm@250mA_P=8.51443W_I=249.8mA

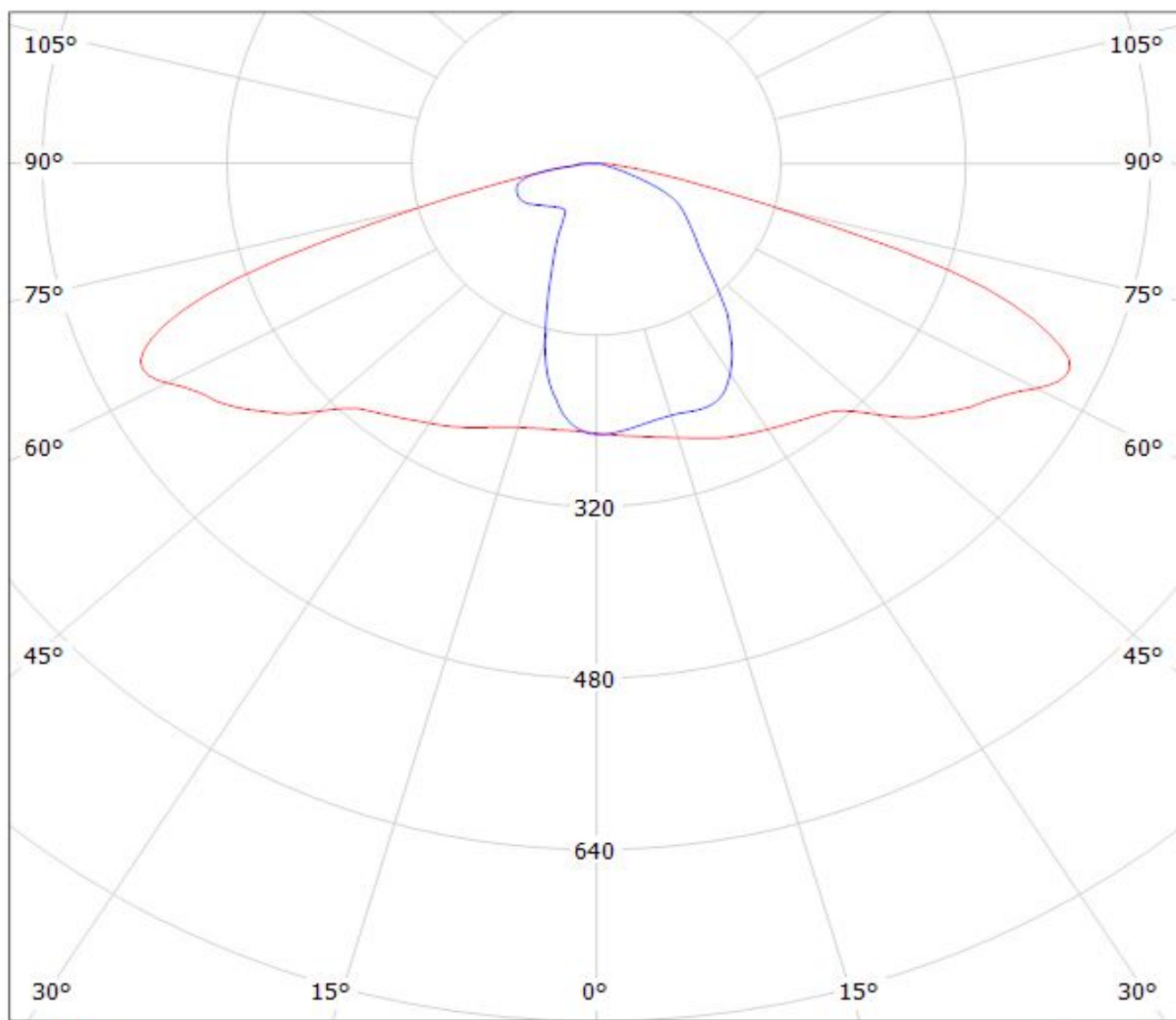

cd/klm

$\eta = 90\%$

— C0 - C180 — C90 - C270

Ledil FN13323_STELLA-A_(NFCLL060B) / LDC (Polar)

Luminaire: Ledil FN13323_STELLA-A_(NFCLL060B)

Lamps: 1 x Nichia_NFCLL060B_(sm406G2450R8000)_1368.94lm@250mA_P=8.5W_I=0.25A

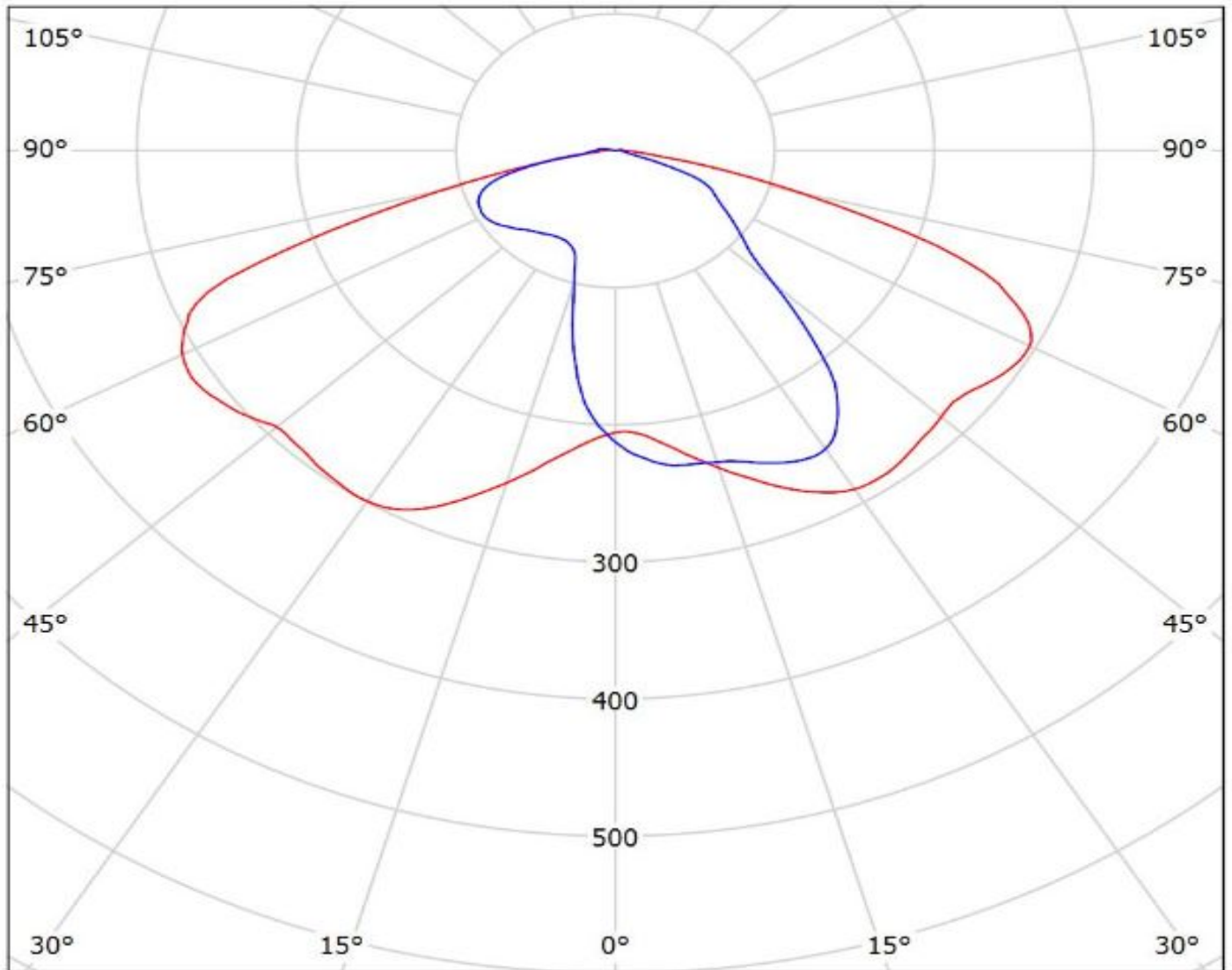

cd/klm

— C0 - C180 — C90 - C270

$\eta = 89\%$

Luminaire: Ledil FN13323_STELLA-A_(Soleriq_P9)

Lamps: 1 x Osram_Soleriq_P9_(GW_MAFJB1.EM)_976.011lm@250mA_CCT=4299K_P=6.9W_I=0.25A

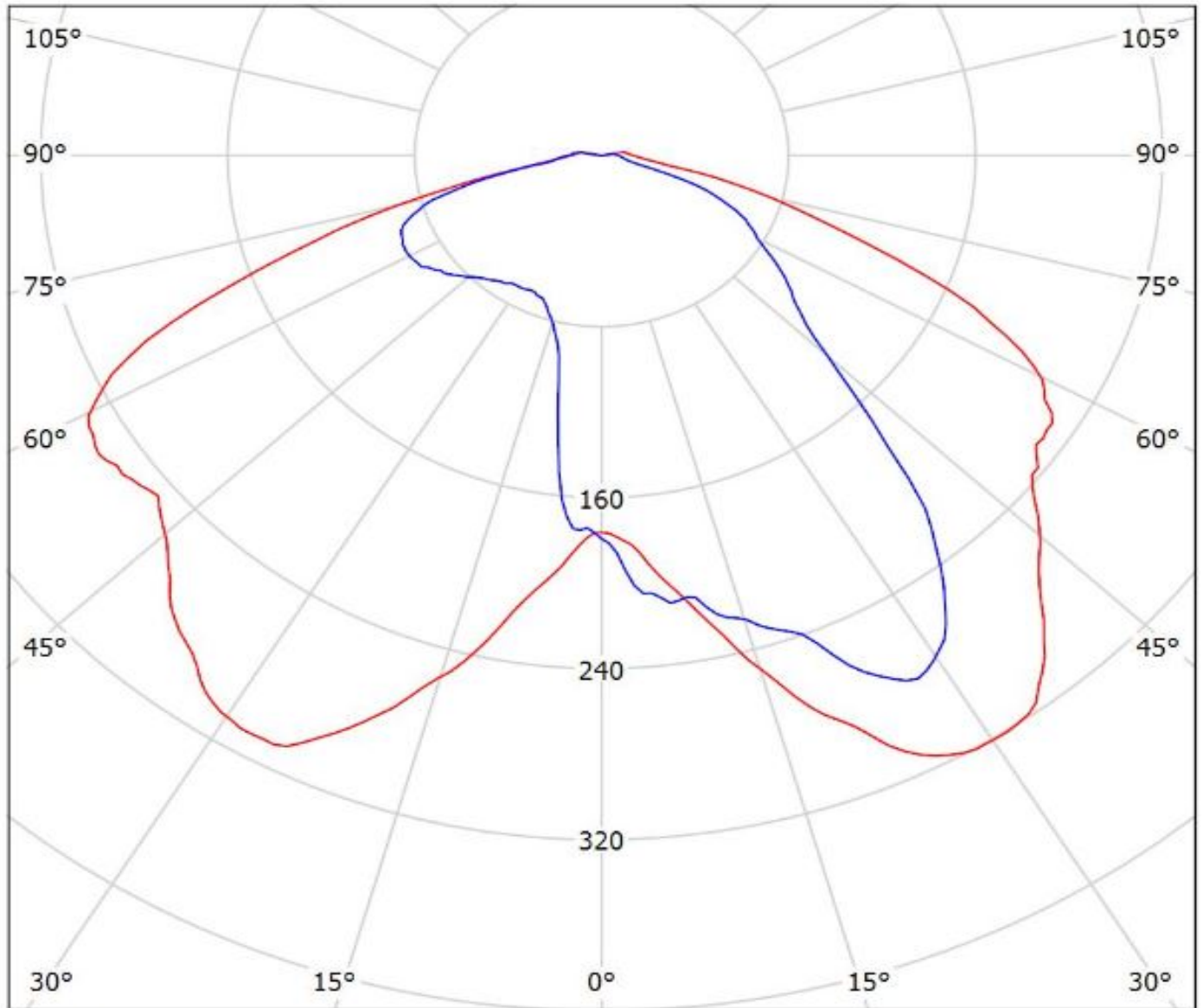

cd/klm
— C0 - C180 — C90 - C270

$\eta = 88\%$

NOTE: The typical divergence will be changed by different color, chip size and chip position tolerance. The typical total divergence is the full angle measured where the luminous intensity is half of the peak value.

GENERAL INFORMATION

- Product series especially designed & optimized for series of LEDs.
- Special care taken to make light distribution as uniform as possible.

Note! Due to use of high power COB's with this product, special attention to proper thermal design is highly recommended. LEDiL has no liability for direct, indirect or consecutive damages arising from the LEDiL products being used outside of the recommended temperature range.