

DETAILS

Product Number	F14531_JENNY-CY
Family	Jenny
Type	Lens
Color	clear
Diameter	35 + 35 mm
Height	11.5 mm
Style	rectang
Optic Material	Silicone
Holder Material	
Fastening	
Status	ready
ROHS Compliant	Yes
Date Updated	3/10/2014

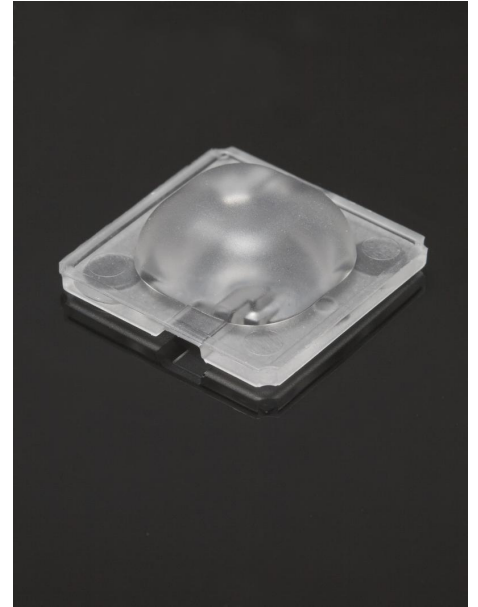

OPTICAL PROPERTIES

LED	Viewing Angle	Light Beam	Efficiency	cd/lm	Connector
V10	102+102 deg	Wide-Area...	94 %	0.430	-
CLU700	102+102 deg	Wide-Area...	93 %	0.470	-
Duris S8	102+102 deg	Wide-Area...	94 %	0.520	-
CLL02x/CLU024	103+103 deg	Wide-Area...	93 %	0.400	-
XM-L EZW	103+103 deg	Wide-Area...	94 %	0.460	-
Luxeon 5258	103+103 deg	Wide-Area...	94 %	0.490	-
CLL01x	104+104 deg	Wide-Area...	94 %	0.440	-
LUXEON M	104+104 deg	Wide-Area...	94 %	0.450	-
V8	105+105 deg	Wide-Area...	94 %	0.400	-
CXA1310	105+105 deg	Wide-Area...	94 %	0.410	-
NSMx286M	105+105 deg	Wide-Area...	94 %	0.410	-
MK-R	105+105 deg	Wide-Area...	92 %	0.420	-
XHP50	105+105 deg	Wide-Area...	94 %	0.420	-
Solericq P9	106+106 deg	Wide-Area...	94 %	0.390	-
CXA15xx	106+106 deg	Wide-Area...	94 %	0.380	-
Solericq P6	107+107 deg	Wide-Area...	94 %	0.400	-
V6	110+110 deg	Wide-Area...	94 %	0.350	-

Relative intensity of F14531_JENNY-CY_(XHP-50)

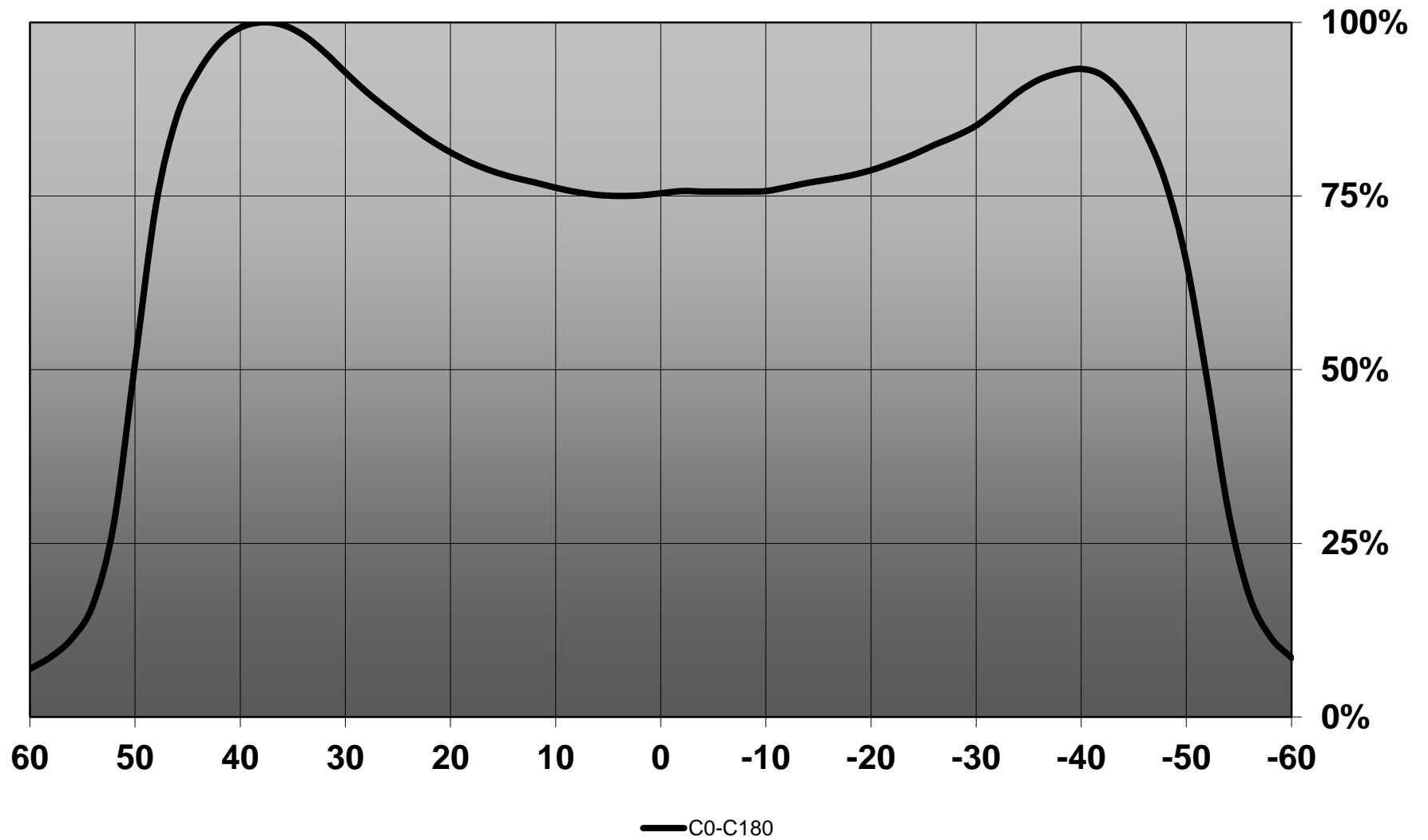

4

Bottom view

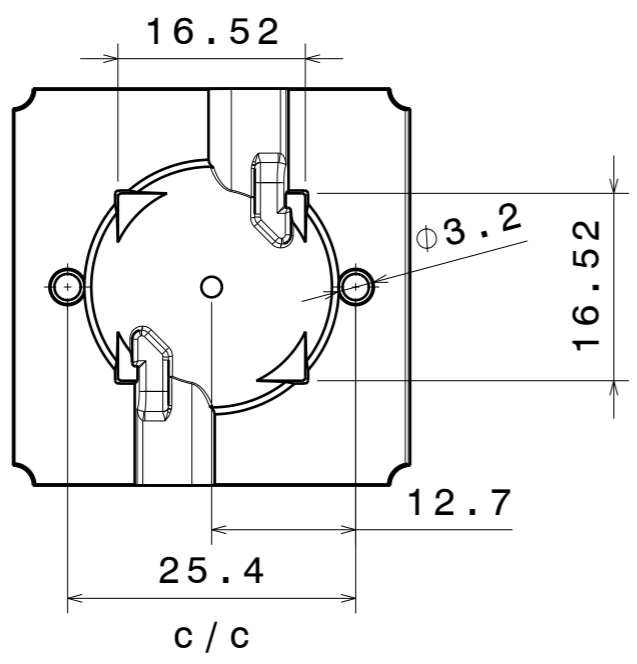

3

Front view

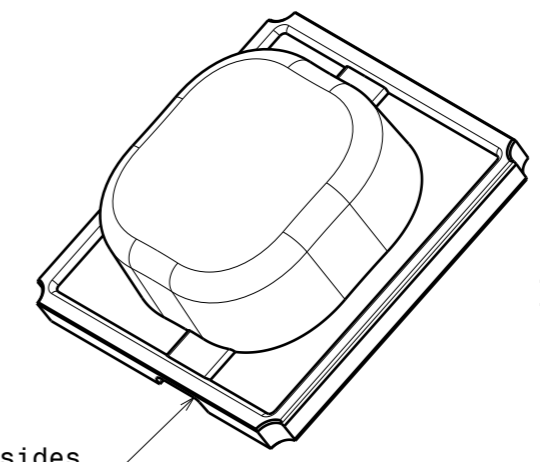
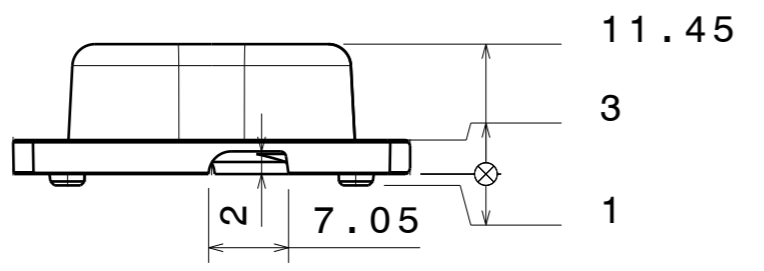

Isometric view

Wire outlet both sides

2

Top view

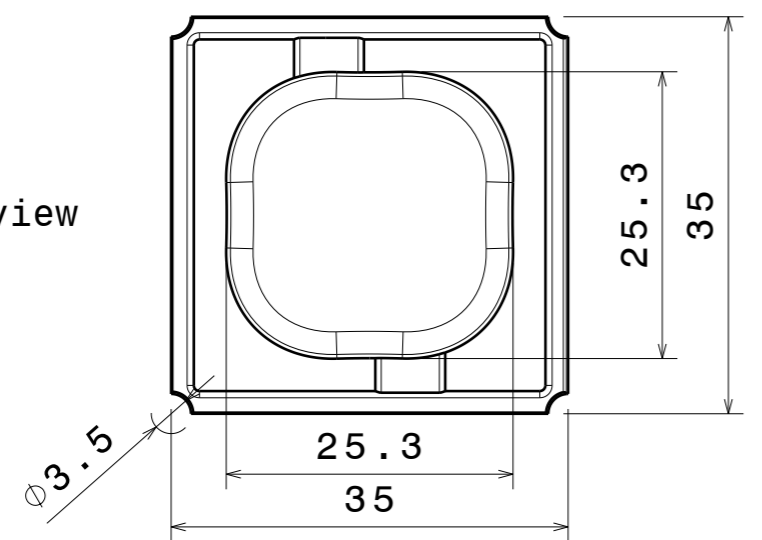

1

When thermal adhesive tape is used, recommended tape thickness up to 0.3mm. When assembling led ensure correct position in relation to lens position pin hole.

- Recommended tape examples:
- Bergquist 0,279 mm
 - Kerafol 0,3 mm
 - PPI 0,210 mm

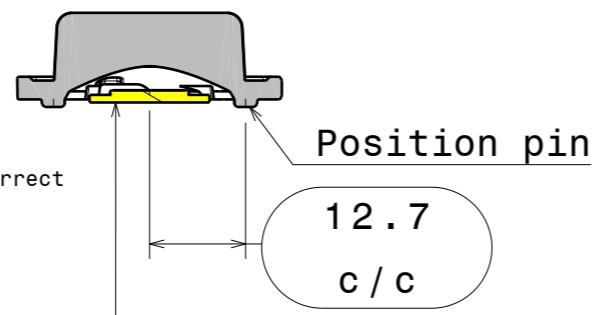

Section view B-B
Scale: 1:1

INDEX	PART NO	DESCRIPTION	MATERIAL	COLOUR
1	F14531	JENNY-CY	Optical grade silicon	

Tolerances if not otherwise shown
According to DIN ISO 2768-1
Linear measures:
class C.
According to DIN ISO 2768-2
Form and position: class L

LEDiL LediL Oy
Salorankatu 10
FIN 24240 SALO
Finland

THIRD ANGLE PROJECTION:

DRAWING TITLE
F14531_JENNY-CY

This drawing is the property of LEDiL Oy. It may not be reproduced, copied or communicated without a written agreement with LEDiL Oy.

SIZE	PART NUMBER
A3	F14531

SCALE	1:1	WEIGHT		SHEET	1/1
-------	-----	--------	--	-------	-----

Luminaire: LEDiL Oy F14325_JENNY-8X1-CY_(V10)

Lamps: 1 x BRIDGELUX_V10_(BXRE-30E1000B-X2)_6100lm@250mA_P=50W_I=249.9mA

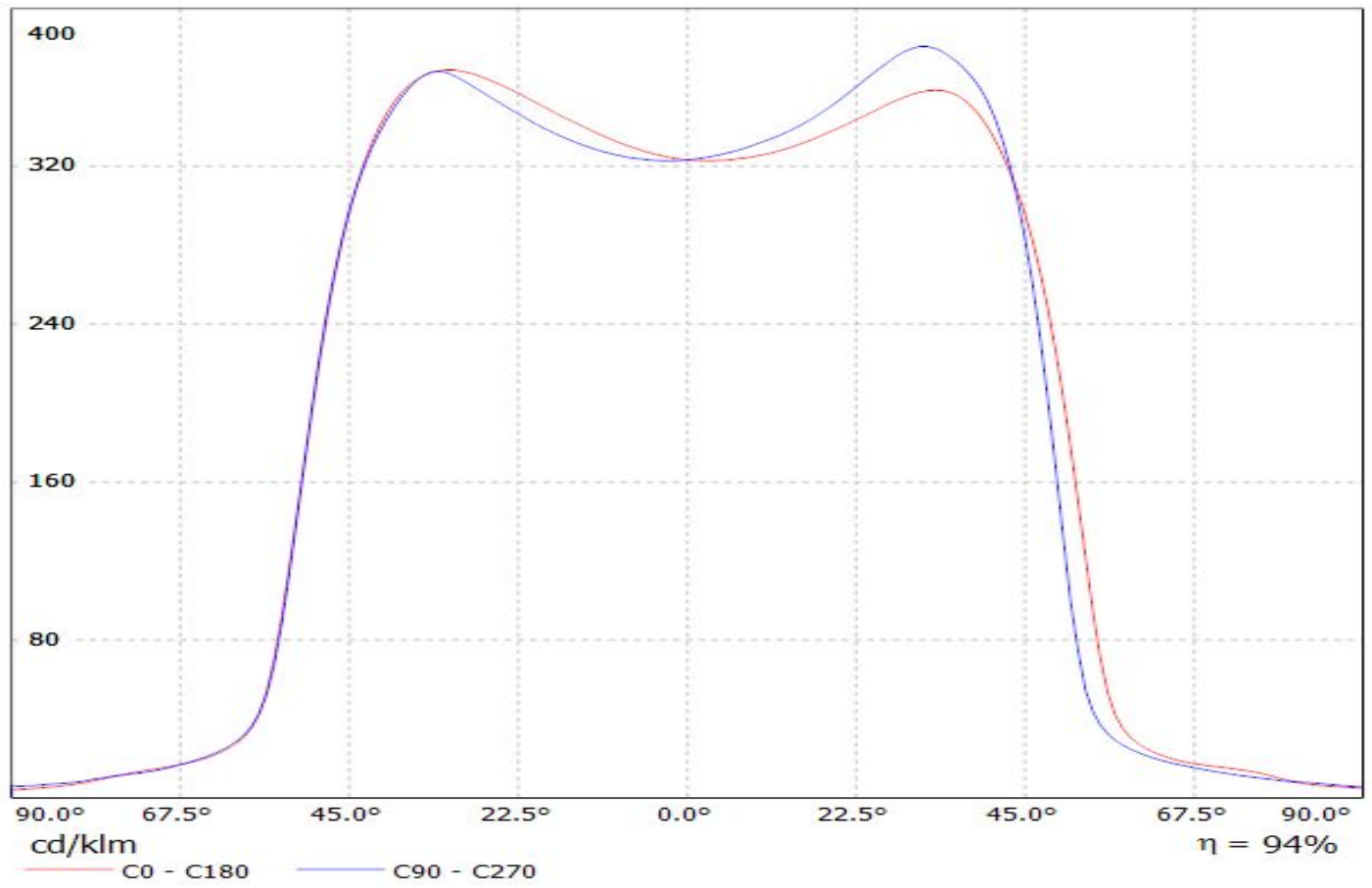

Luminaire: Ledil F14531_JENNY-CY_(CLU700)

Lamps: 1 x Citizen_CLU700_394.637lm@100mA_P=2.8W_I=0.10A

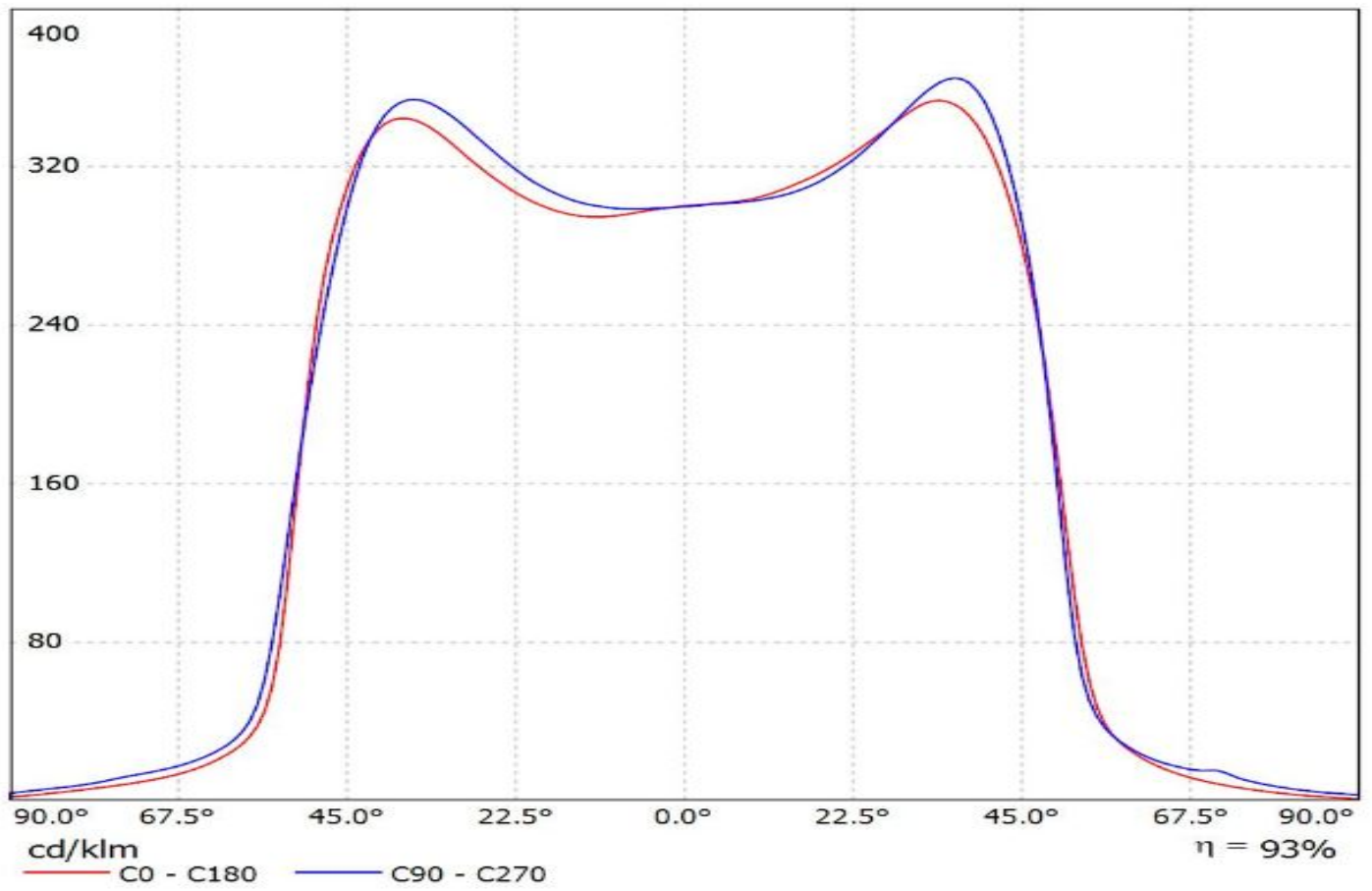

Ledil F14531_JENNY-CY_(Duris_S8) / LDC (Linear)

Luminaire: Ledil F14531_JENNY-CY_(Duris_S8)

Lamps: 1 x Osram_Duris_S8_(GW_P9LMS1.EC)_201.491lm@100mA_CCT=2857K_P=1.8W_I=0.1A

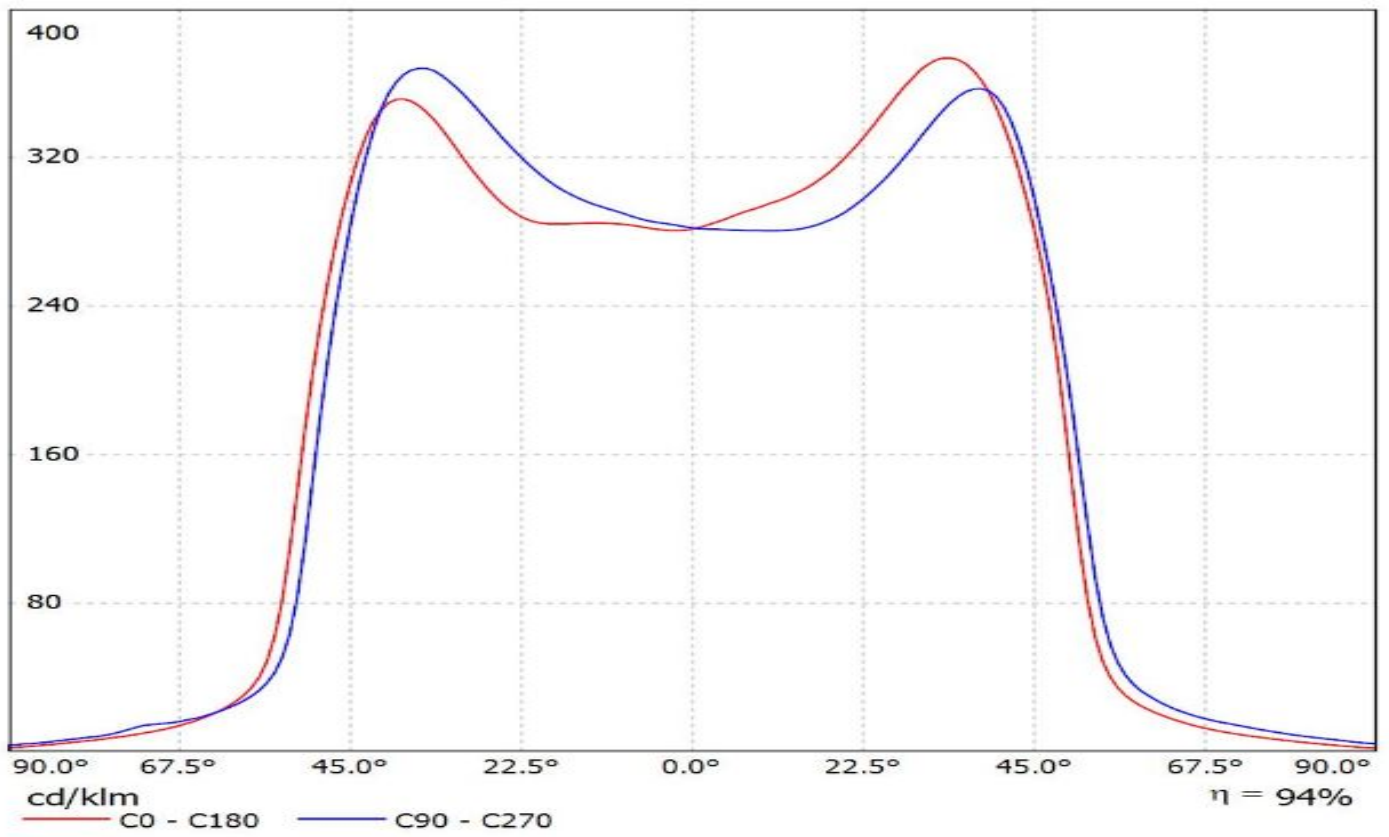

Luminaire: LEDiL Oy F14531_JENNY-CY_(CLL022)

Lamps: 1 x CITIZEN_CLL022_(CLL022-1204A5-030H7E1)_748.012lm@250mA_P=8.70803W_I=249.8mA

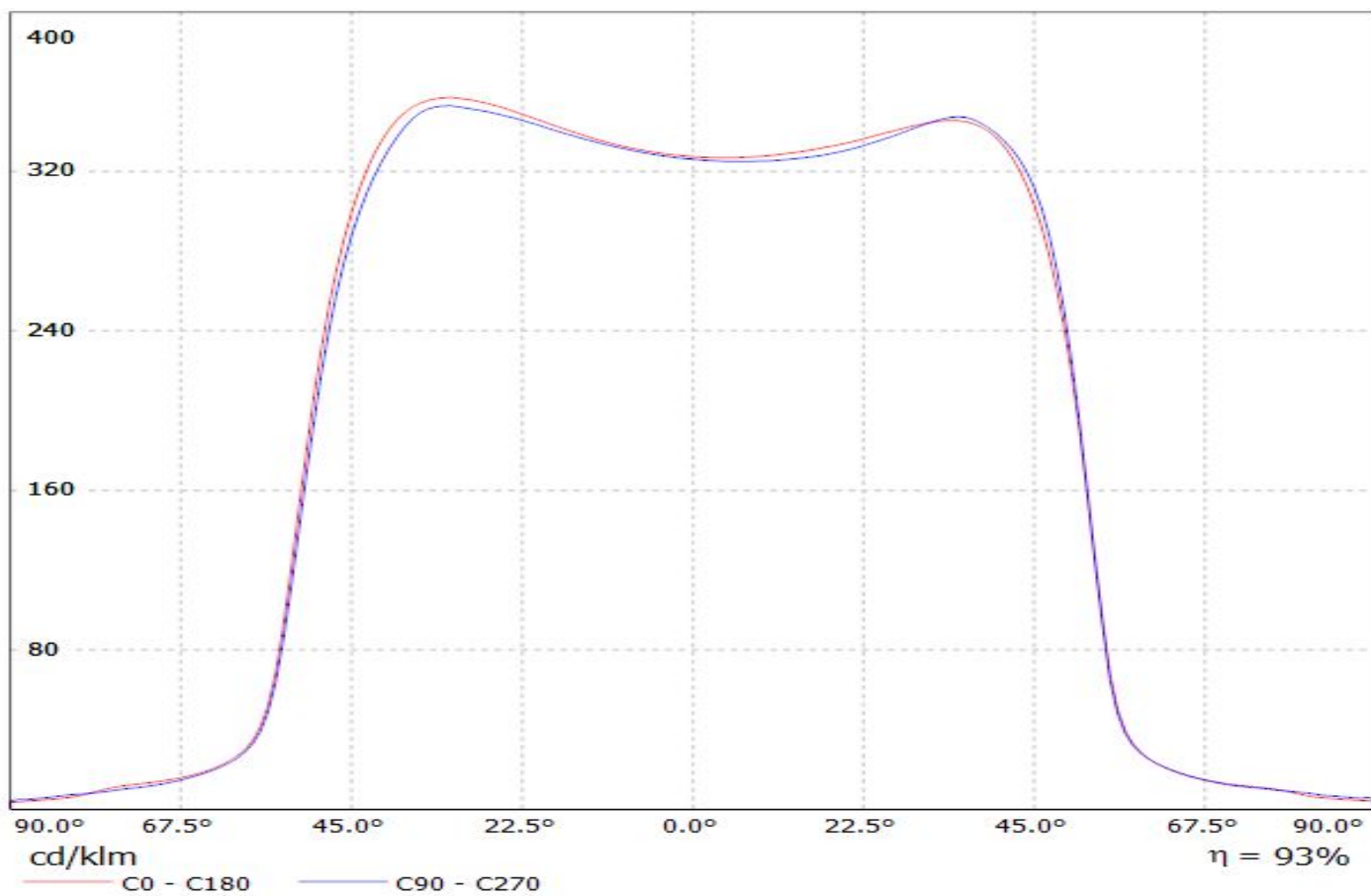

Luminaire: LEDiL Oy F14531_JENNY-CY_(XM-L)

Lamps: 1 x CREE_XM-L_EZW_130.03lm@250mA_P=1.50385W_I=249.9mA

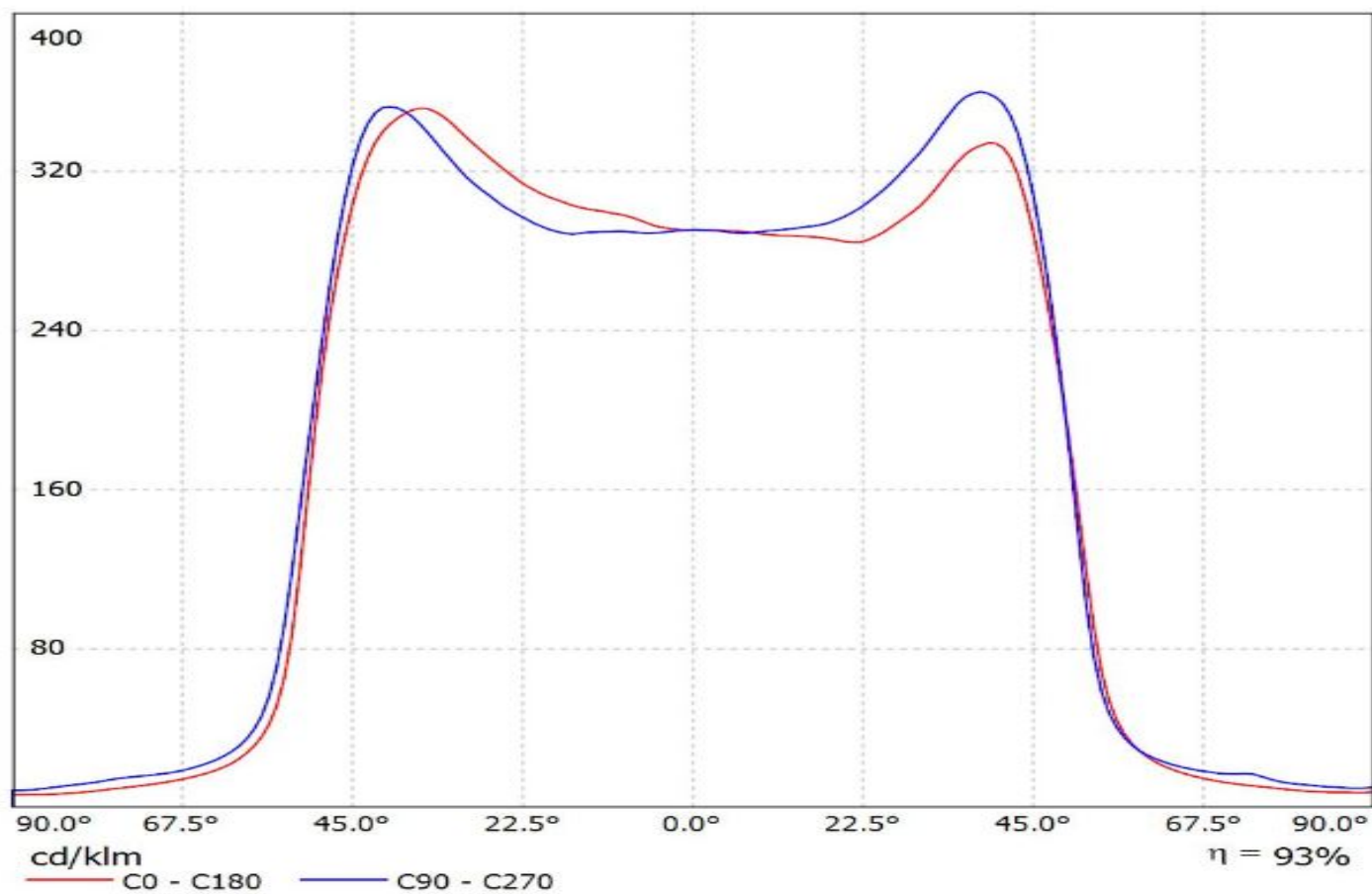

Ledil F14531_JENNY-CY_(LUXEON_5258) / LDC (Linear)

Luminaire: Ledil F14531_JENNY-CY_(LUXEON_5258)

Lamps: 1 x LUXEON_5258_(24VOLTS)_307.573lm@100mA_CCT=2700K_P=?W_I=0.1A

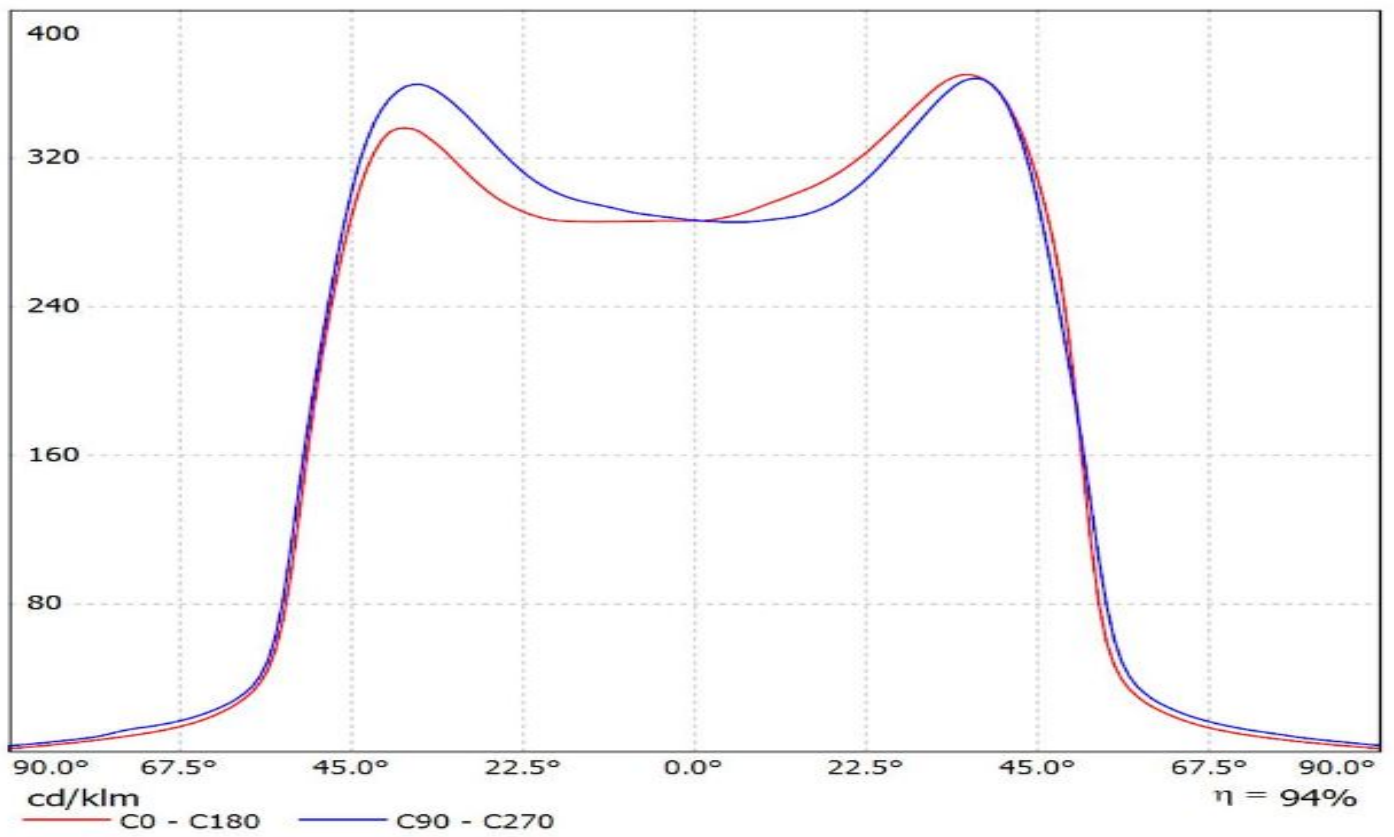

Luminaire: LEDiL Oy F14531_JENNY-CY_(CLL010)
Lamps: 1 x CITIZEN CLL010_(CLL010-0305A1-303M1A2)
_206.314lm@250mA_P=2.27184W_I=249.9mA

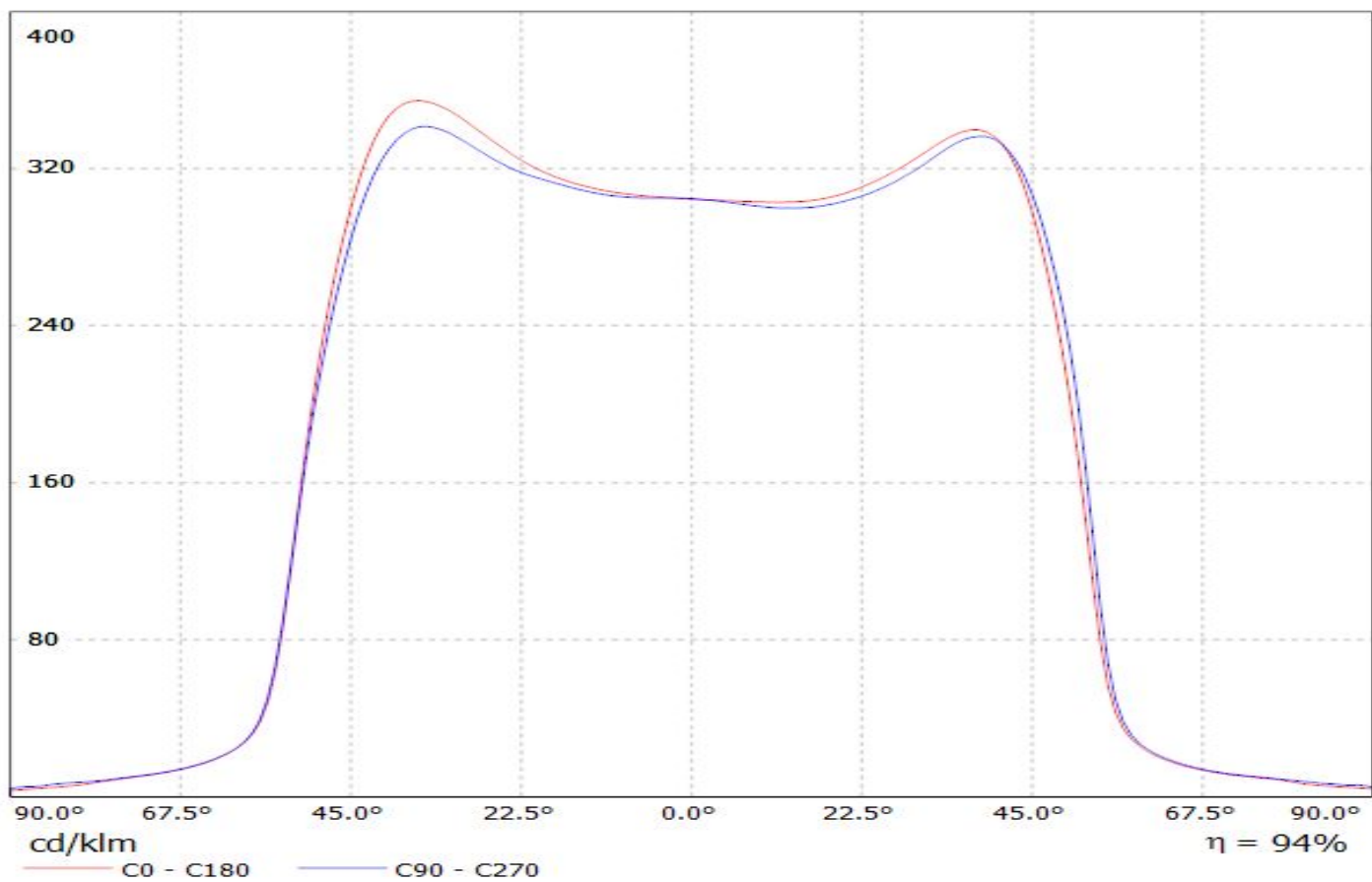

Luminaire: LEDiL Oy F14531_JENNY-CY_(LUXEON_M)

Lamps: 1 x LUXEON_M_(LXR7-SW40)_318.732lm@250mA_P=2.72282W_I=249.8mA

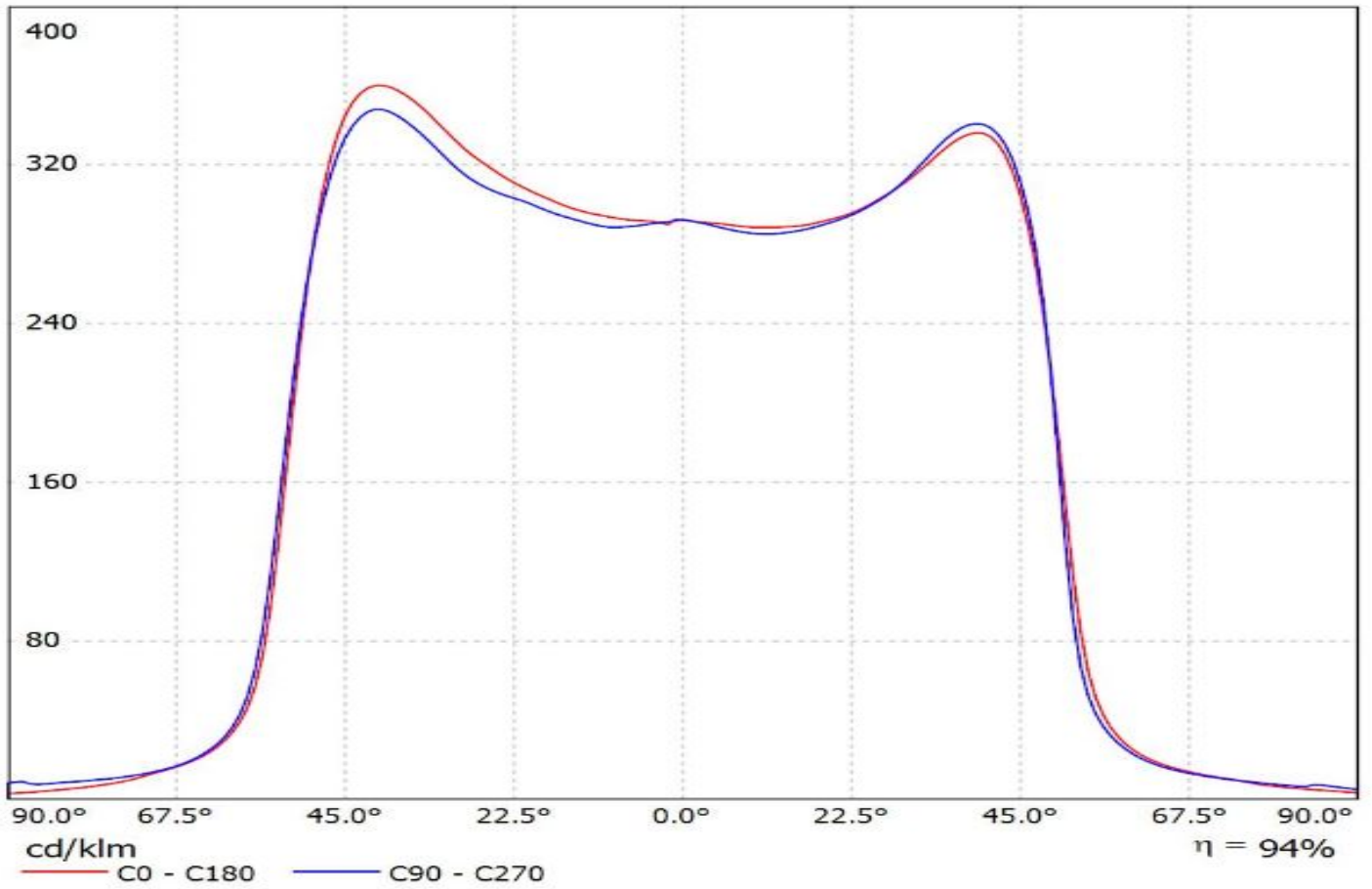

Luminaire: LEDiL Oy F14531_JENNY-CY_(V8)

Lamps: 1 x BRIDGELUX_V8_871.869lm@250mA_P=8.88614W_I=249.8mA

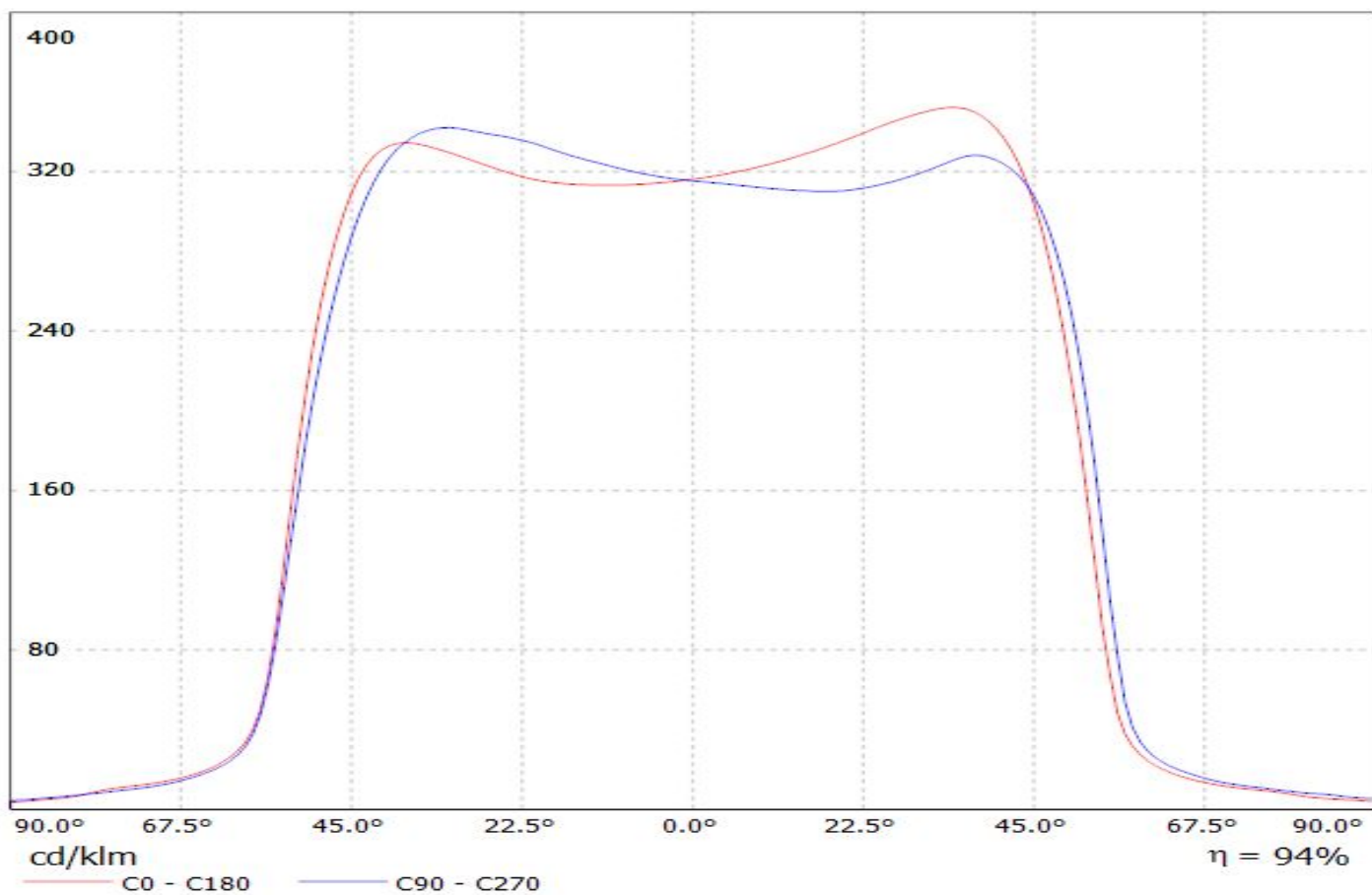

Luminaire: LEDiL Oy F14531_JENNY-CY_(CXA1310)
Lamps: 1 x CREE_CXA1310_(CXA1310-30H-G4-F0Y-00001)
_367.9lm@250mA_CCT=3000K_P=4.22112W_I=249.8mA

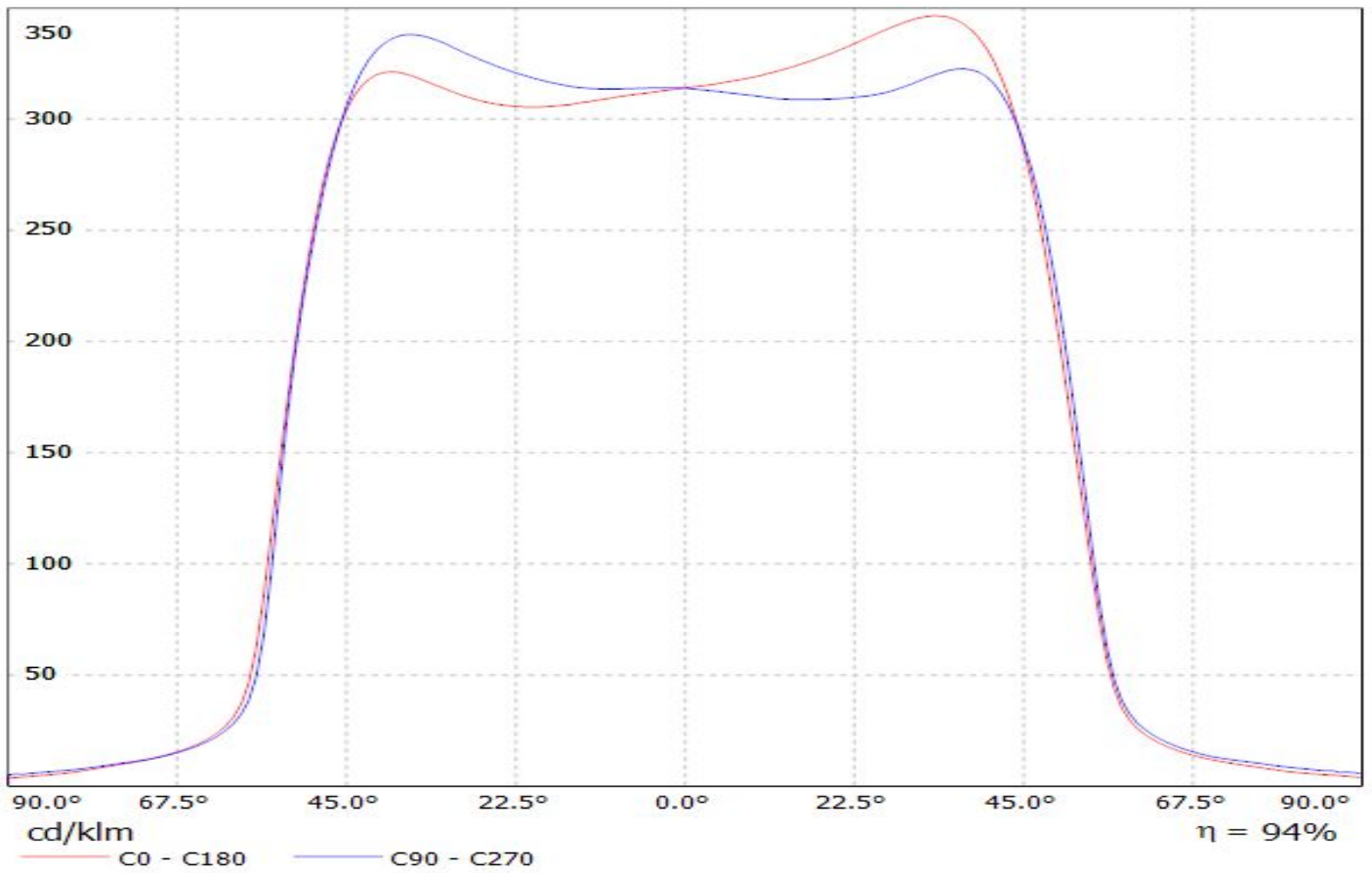

Luminaire: LEDiL Oy F14531_JENNY-CY_(NSMx286M)

Lamps: 1 x NICHIA_NSMx286M_(NSML286ME)_335.4lm@100mA_P=3.43543W_I=100.1mA

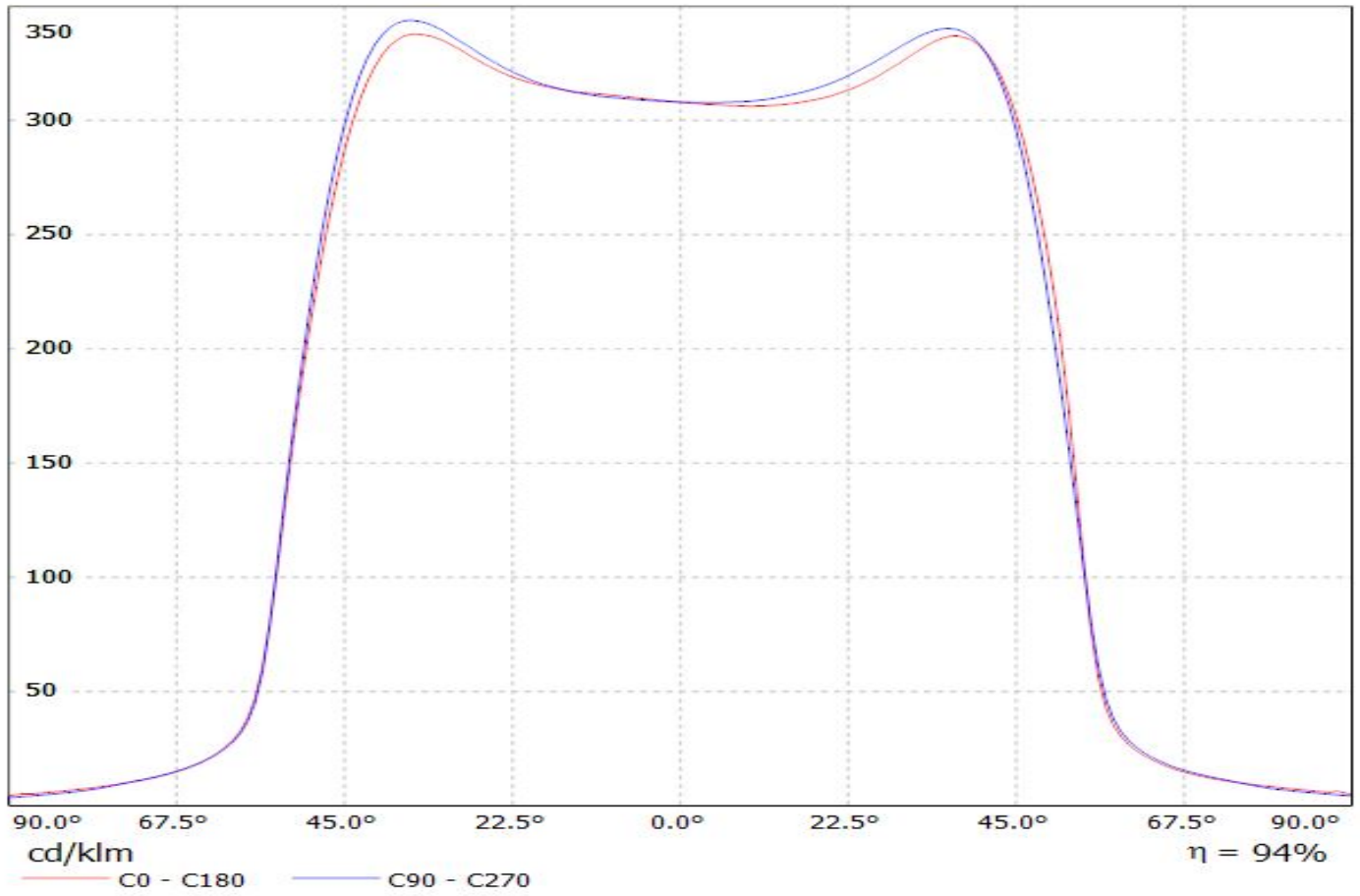

Luminaire: LEDiL Oy F14531_JENNY-CY_(MK-R)

Lamps: 1 x MK-R_353.258lm@250mA_CCT=3276K_P=2.84836W_I=249.9mA

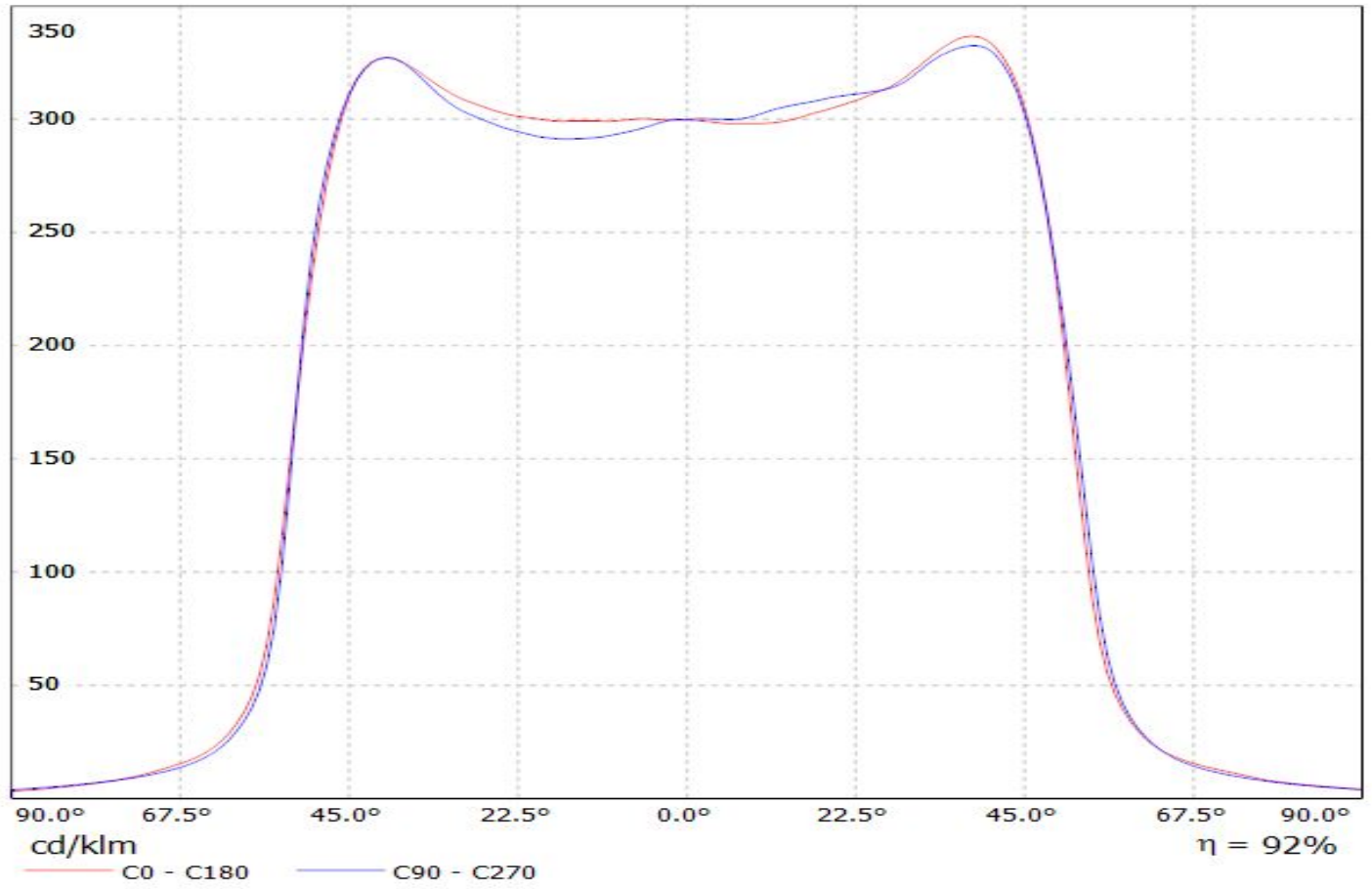

Ledil F14531_JENNY-CY_(XHP50) / LDC (Linear)

Luminaire: Ledil F14531_JENNY-CY_(XHP50)

Lamps: 1 x XHP50_warm_white_210.85lm@250mA_P=1.4W_I=0.25A

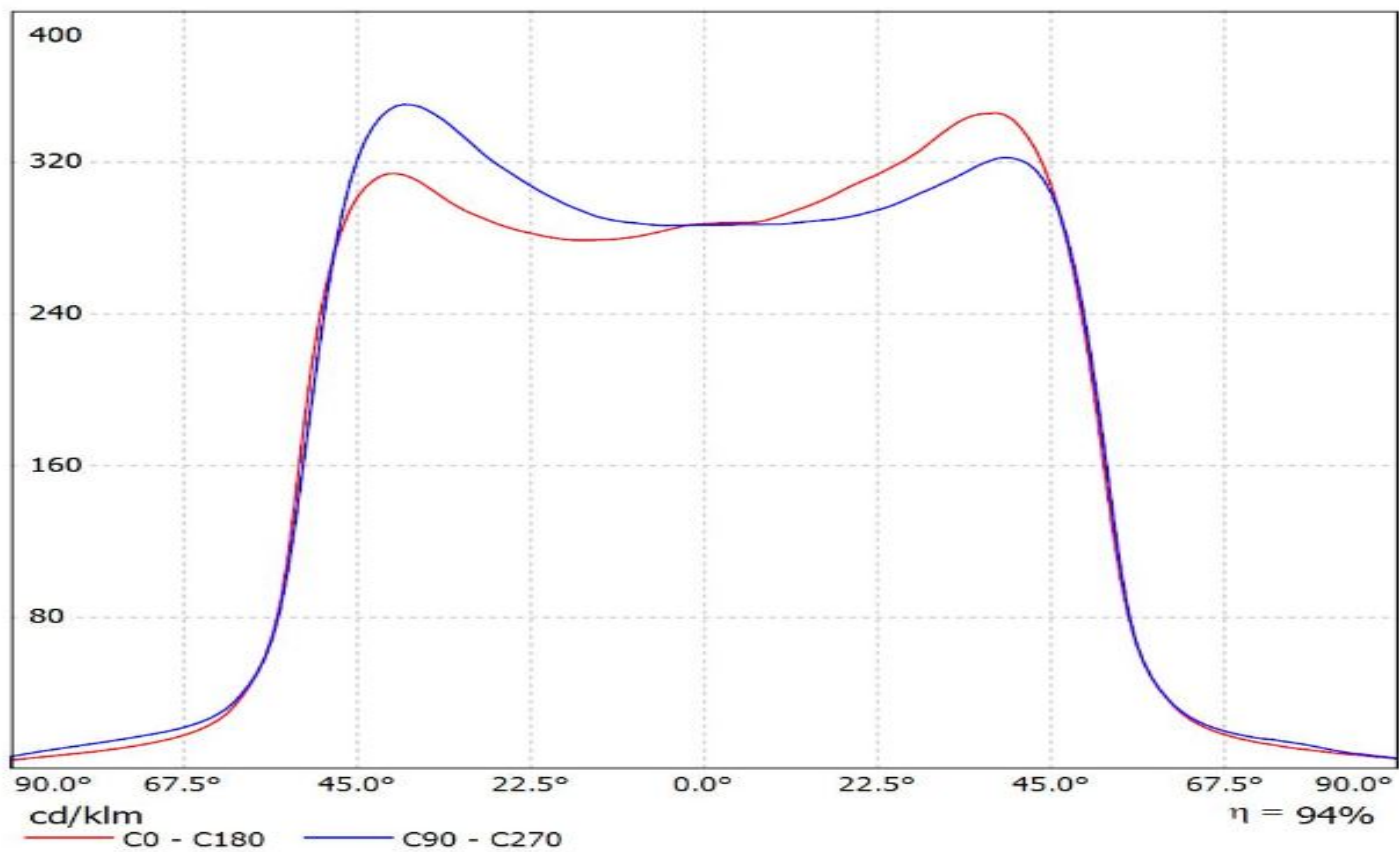

Luminaire: LEDiL Oy F14325_JENNY-8X1-CY_(P9)

Lamps: 1 x OSRAM_SOLERIQ_P9_(GW_MAFJB1.EM)_7200lm@250mA_P=55W_I=249.8mA

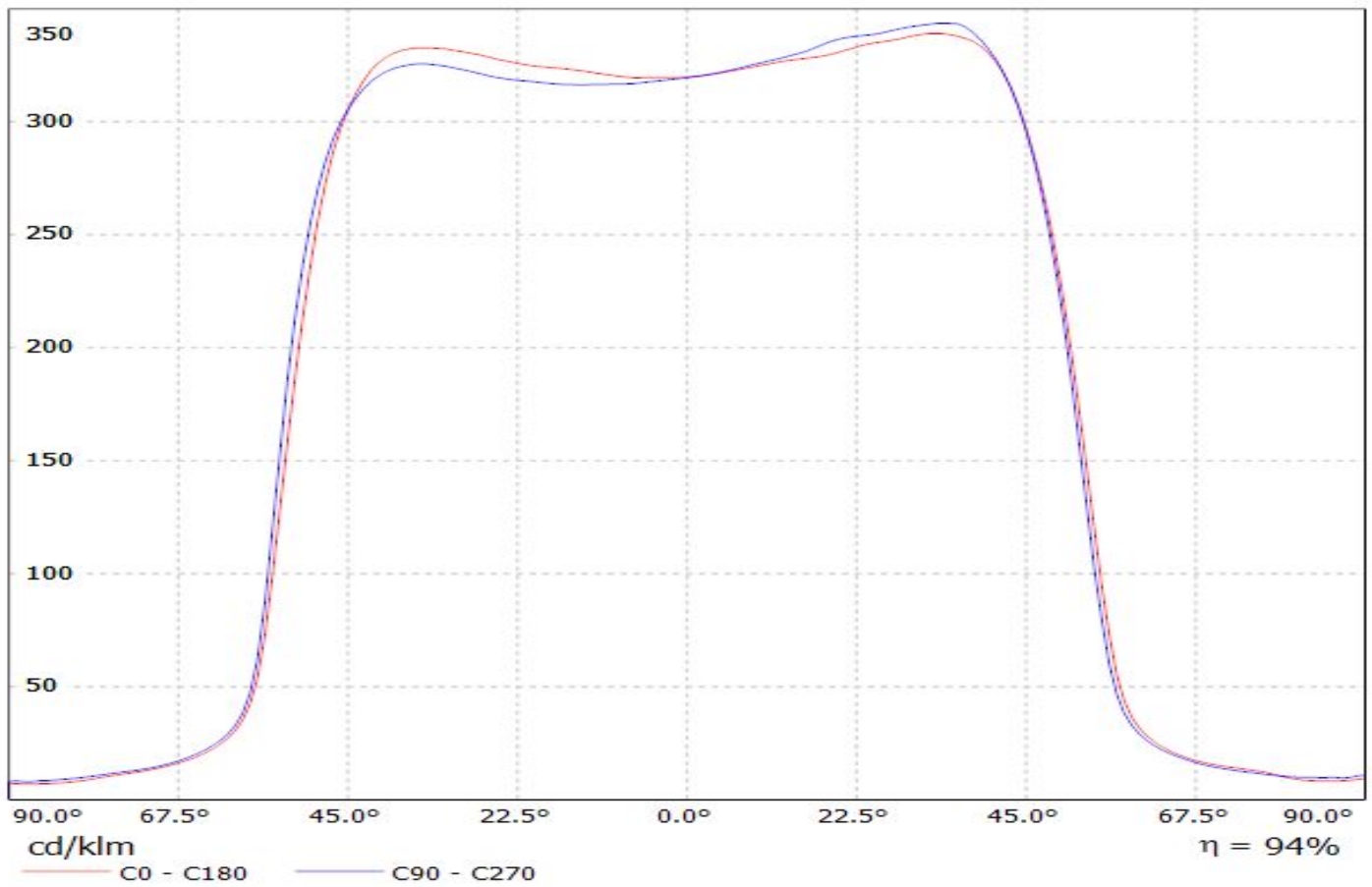

Luminaire: LEDiL Oy F14531_JENNY-CY_(CXA1520)

Lamps: 1 x CREE_CXA1520_(CXA1520-30F-N4-N0H-0001)_976.326lm@250mA_U=8.36855W_I=249.8mA

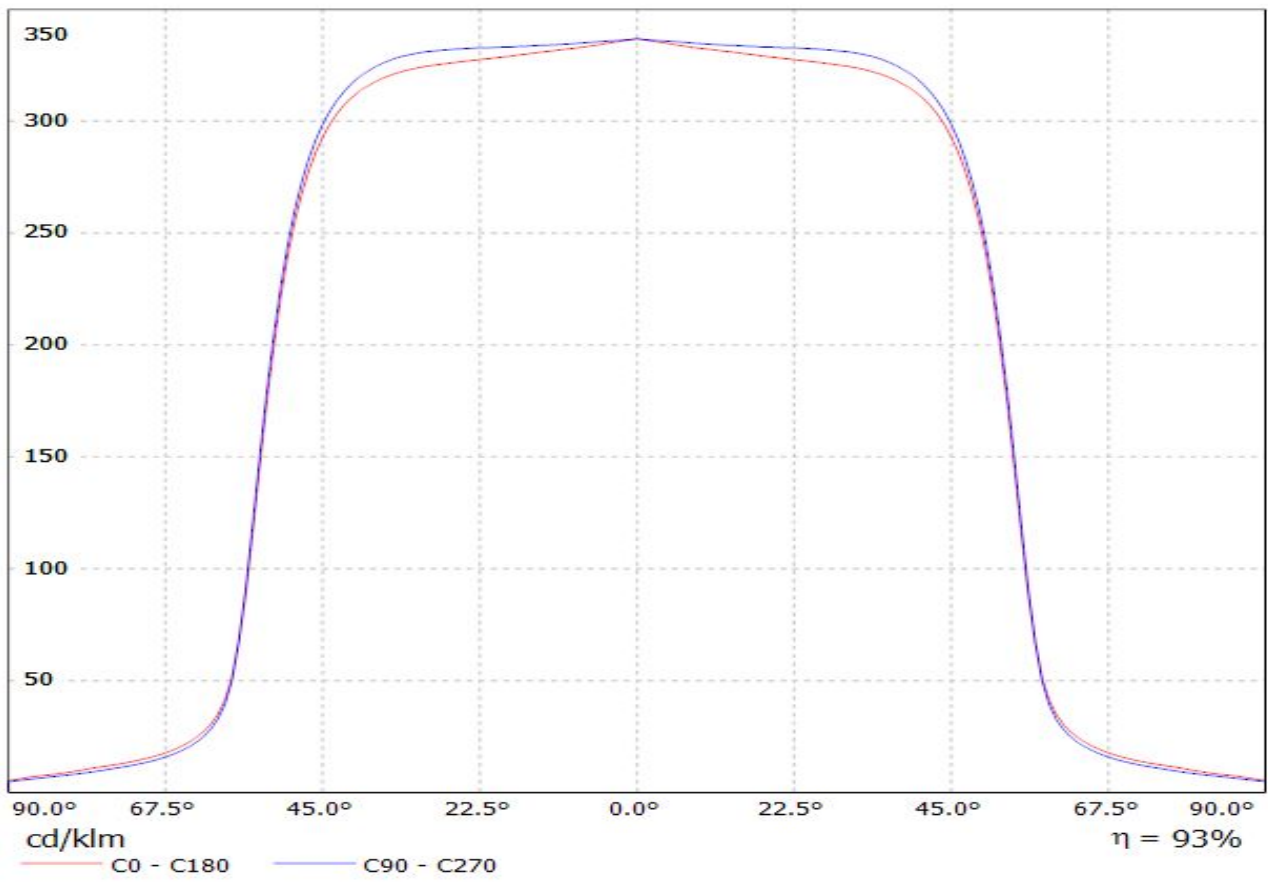

Luminaire: LEDiL Oy F14531_JENNY-CY_(P6)

Lamps: 1 x OSRAM_SOLERIQ_P6_(GW_MAFJB1.EM)_693.953lm@250mA_P=6.29348W_I=249.9mA

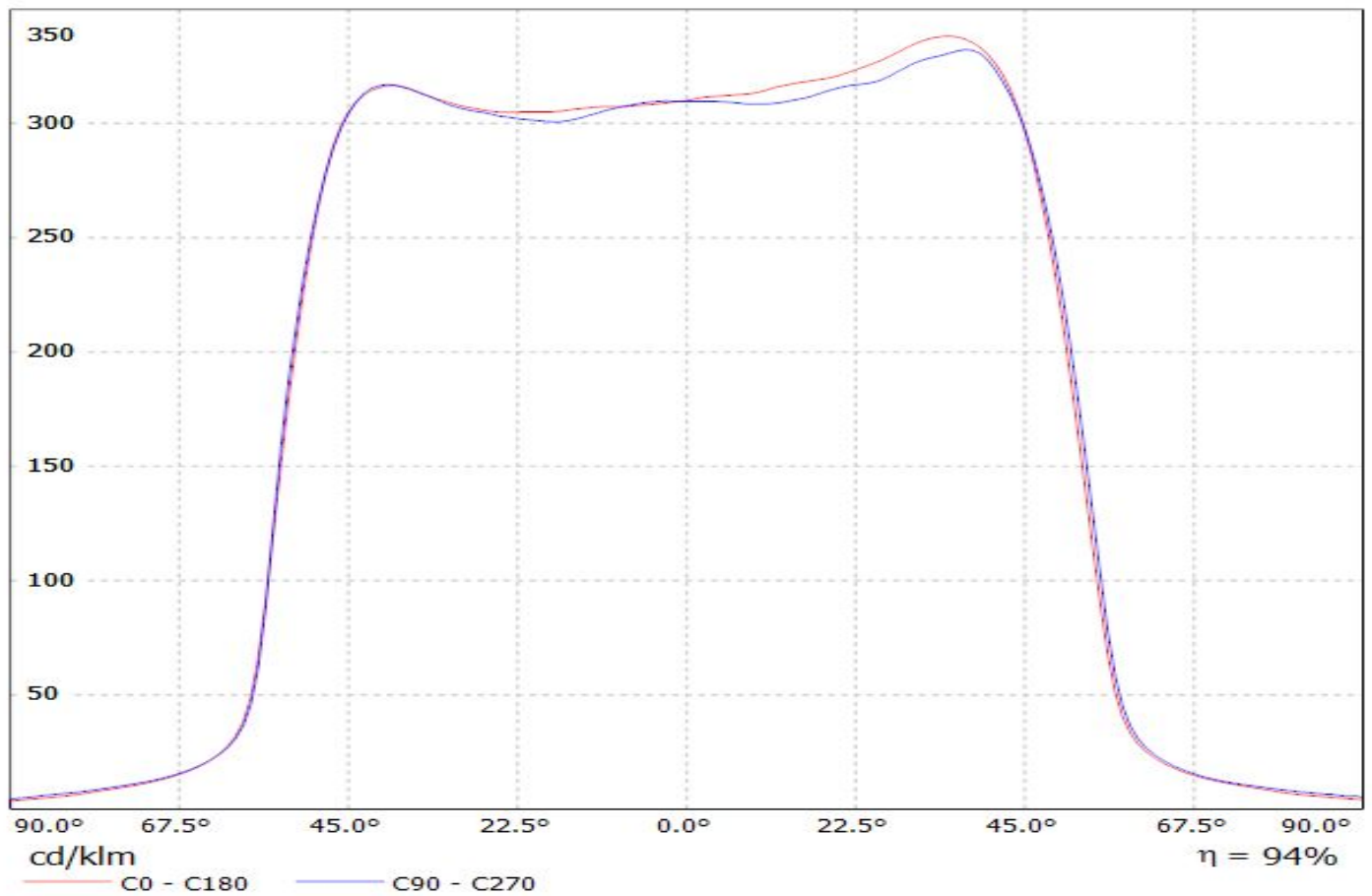

Luminaire: LEDiL Oy F14531_JENNY-CY_(V6)

Lamps: 1 x BRIDGELUX_V6_447.582lm@250mA_P=5.15119W_I=249.9mA

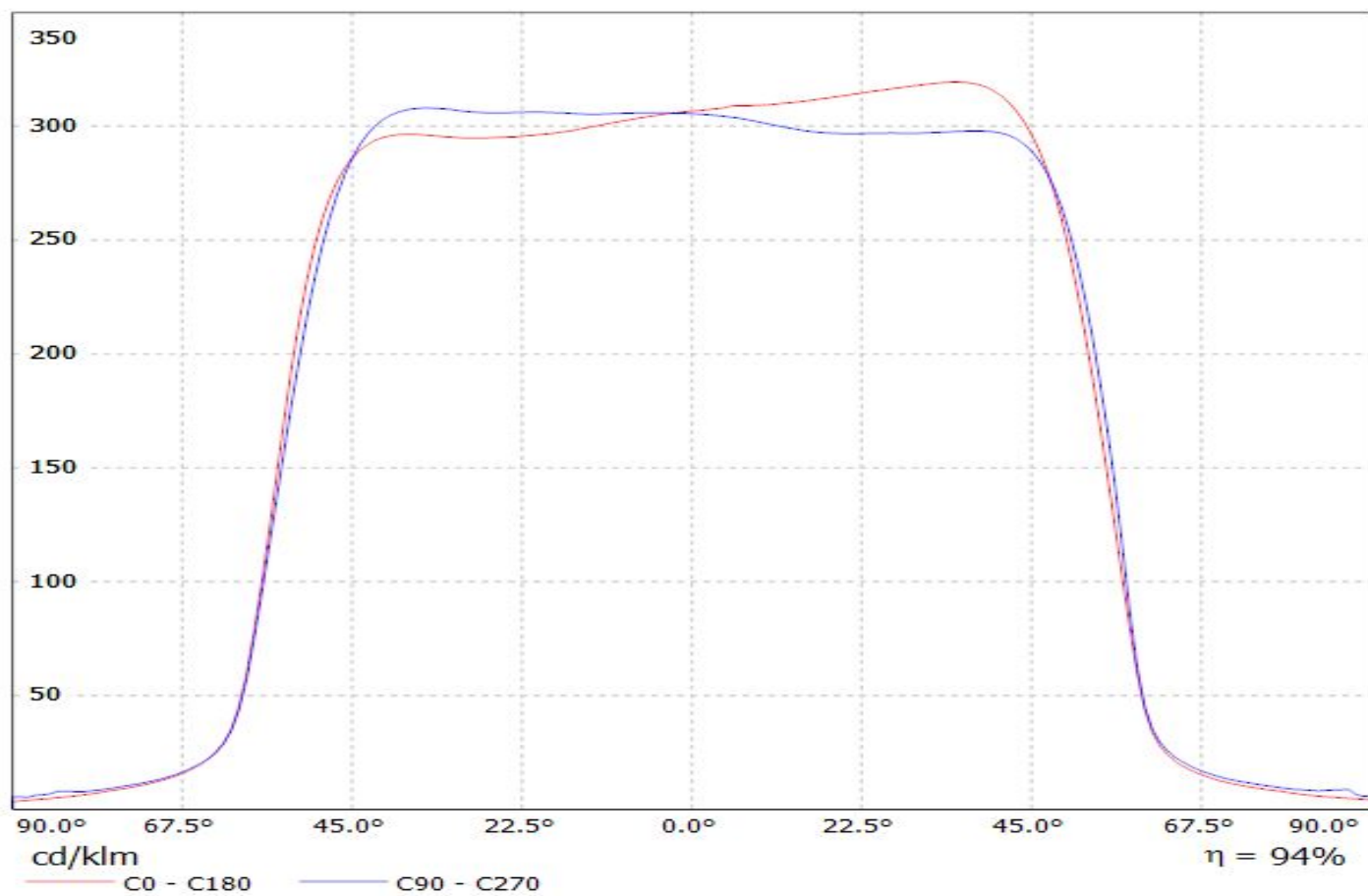

Luminaire: LEDiL Oy F14325_JENNY-8X1-CY_(V10)

Lamps: 1 x BRIDGELUX_V10_(BXRE-30E1000B-X2)_6100lm@250mA_P=50W_I=249.9mA

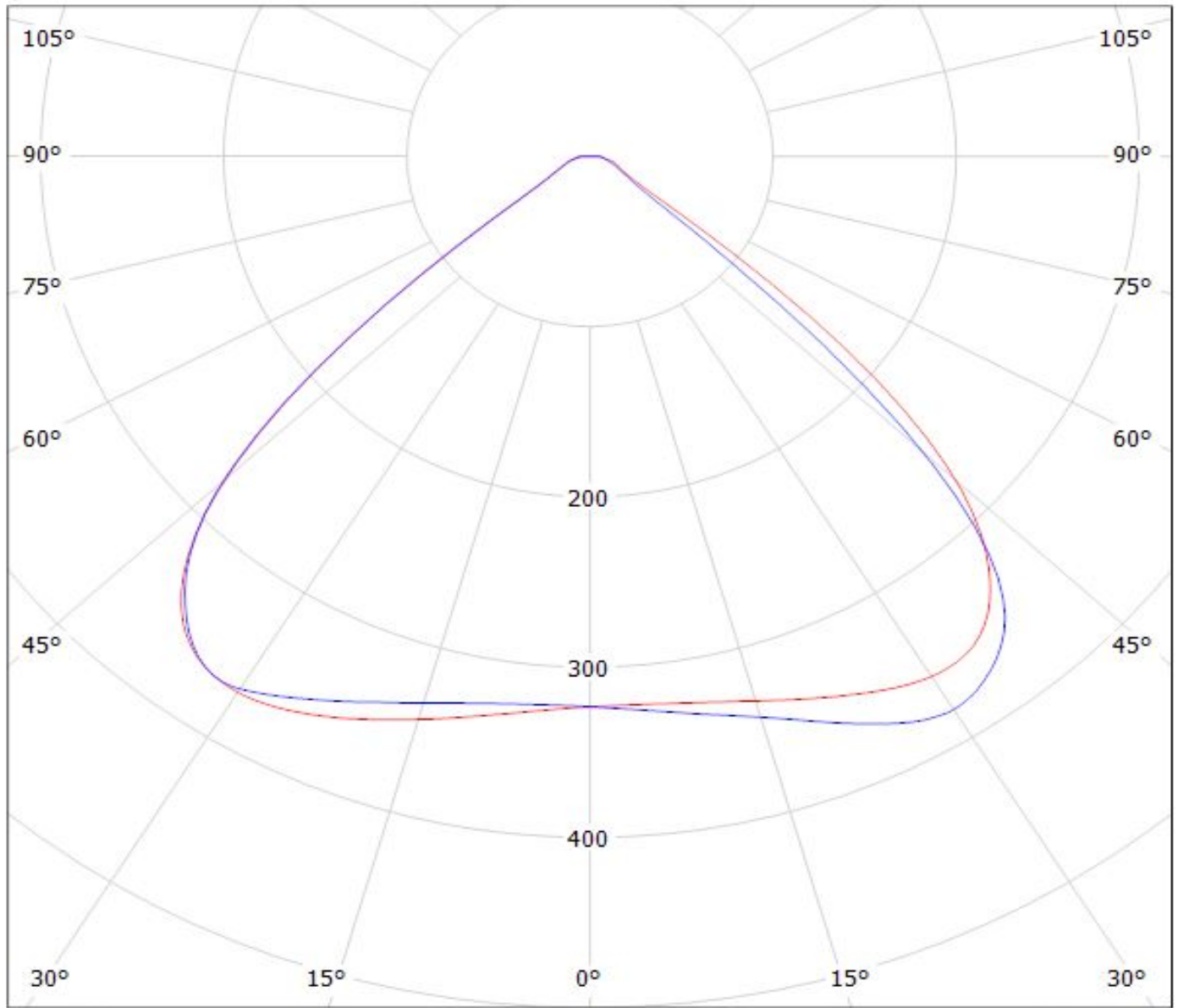

cd/klm

— C0 - C180

— C90 - C270

$\eta = 94\%$

Luminaire: Ledil F14531_JENNY-CY_(CLU700)

Lamps: 1 x Citizen_CLU700_394.637lm@100mA_P=2.8W_I=0.10A

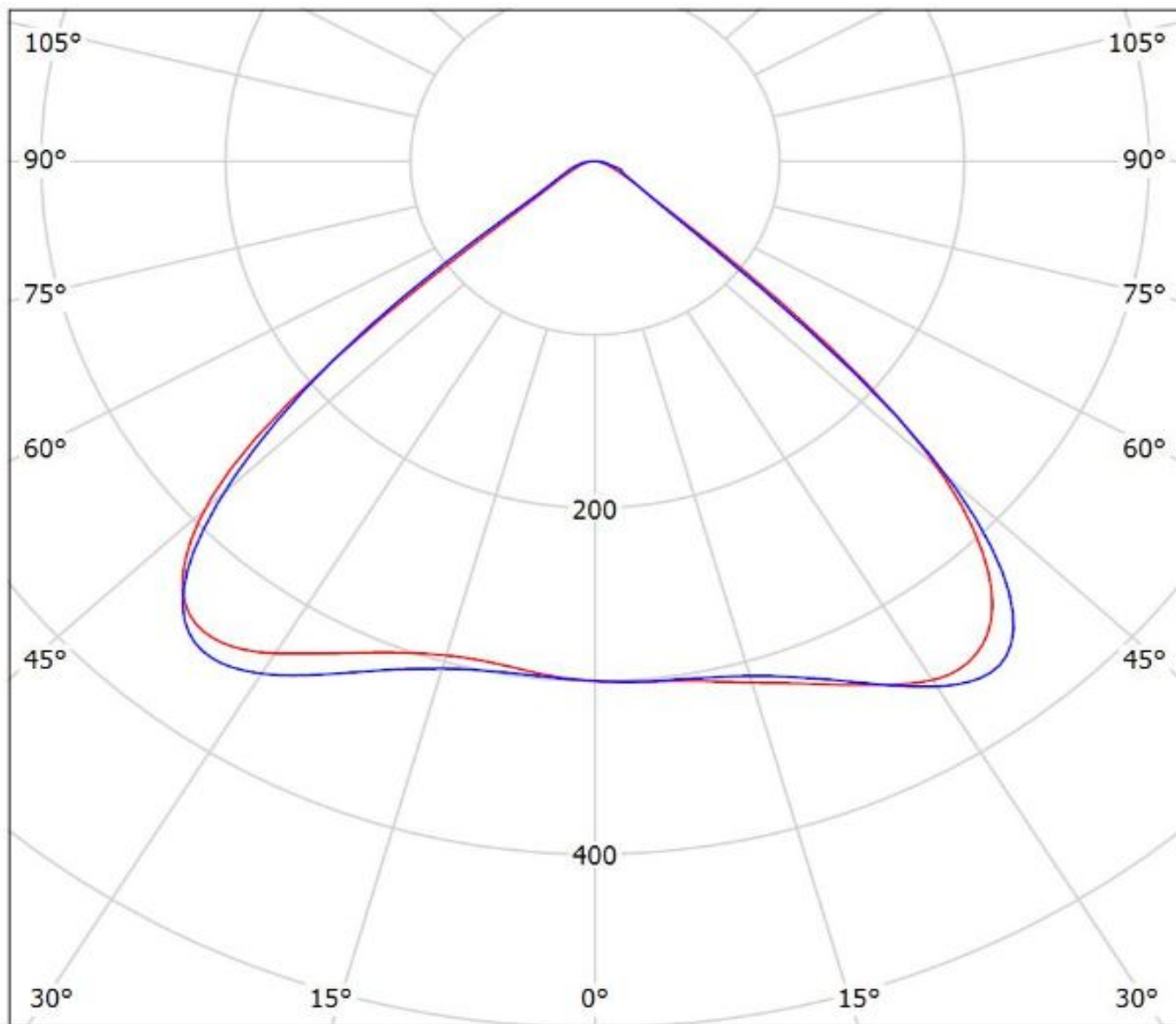

cd/klm

— C0 - C180 — C90 - C270

$\eta = 93\%$

Ledil F14531_JENNY-CY_(Duris_S8) / LDC (Polar)

Luminaire: Ledil F14531_JENNY-CY_(Duris_S8)

Lamps: 1 x Osram_Duris_S8_(GW_P9LMS1.EC)_201.491lm@100mA_CCT=2857K_P=1.8W_I=0.1A

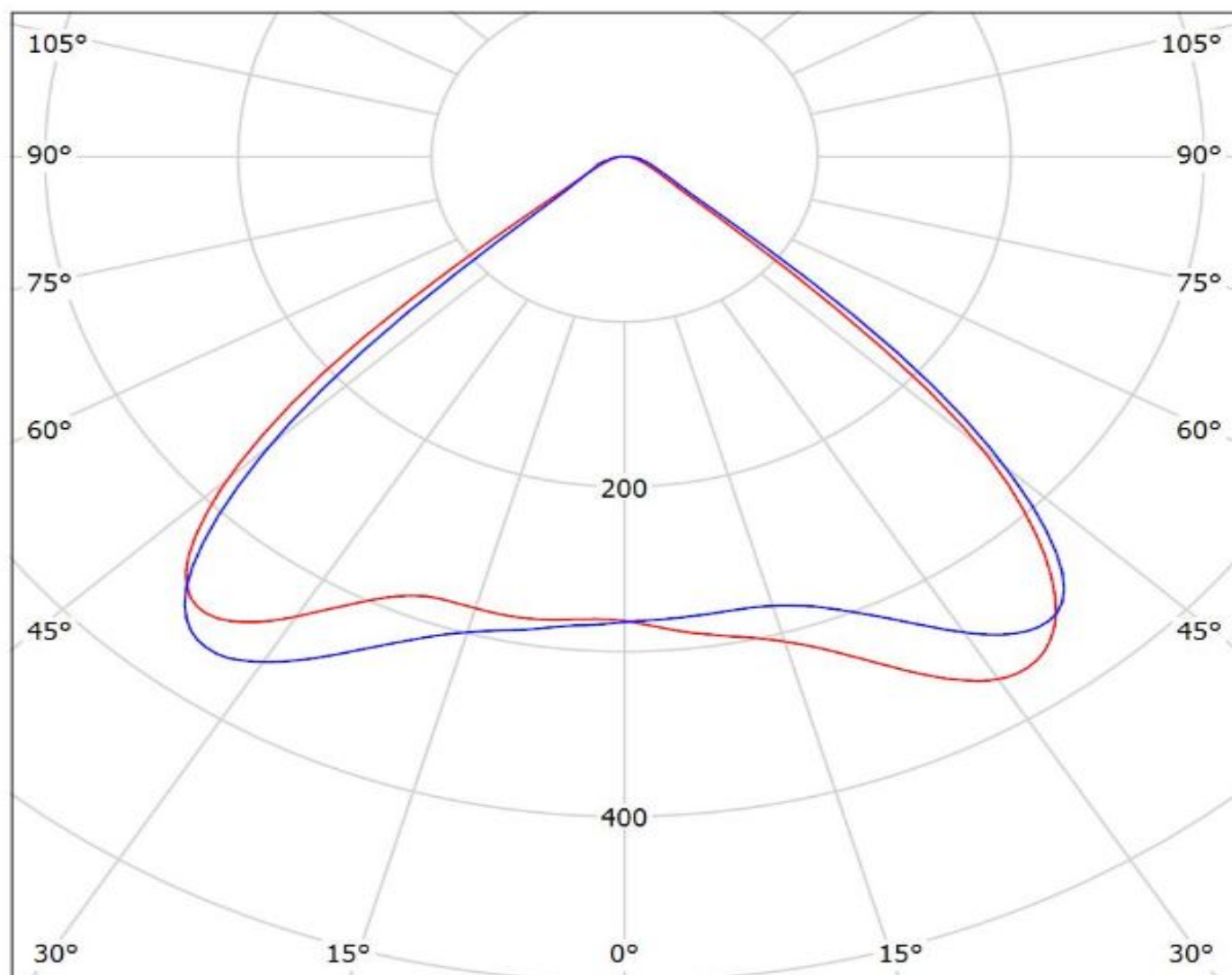

cd/klm

— C0 - C180 — C90 - C270

$\eta = 94\%$

Luminaire: LEDiL Oy F14531_JENNY-CY_(CLL022)

Lamps: 1 x CITIZEN_CLL022_(CLL022-1204A5-030H7E1)_748.012lm@250mA_P=8.70803W_I=249.8mA

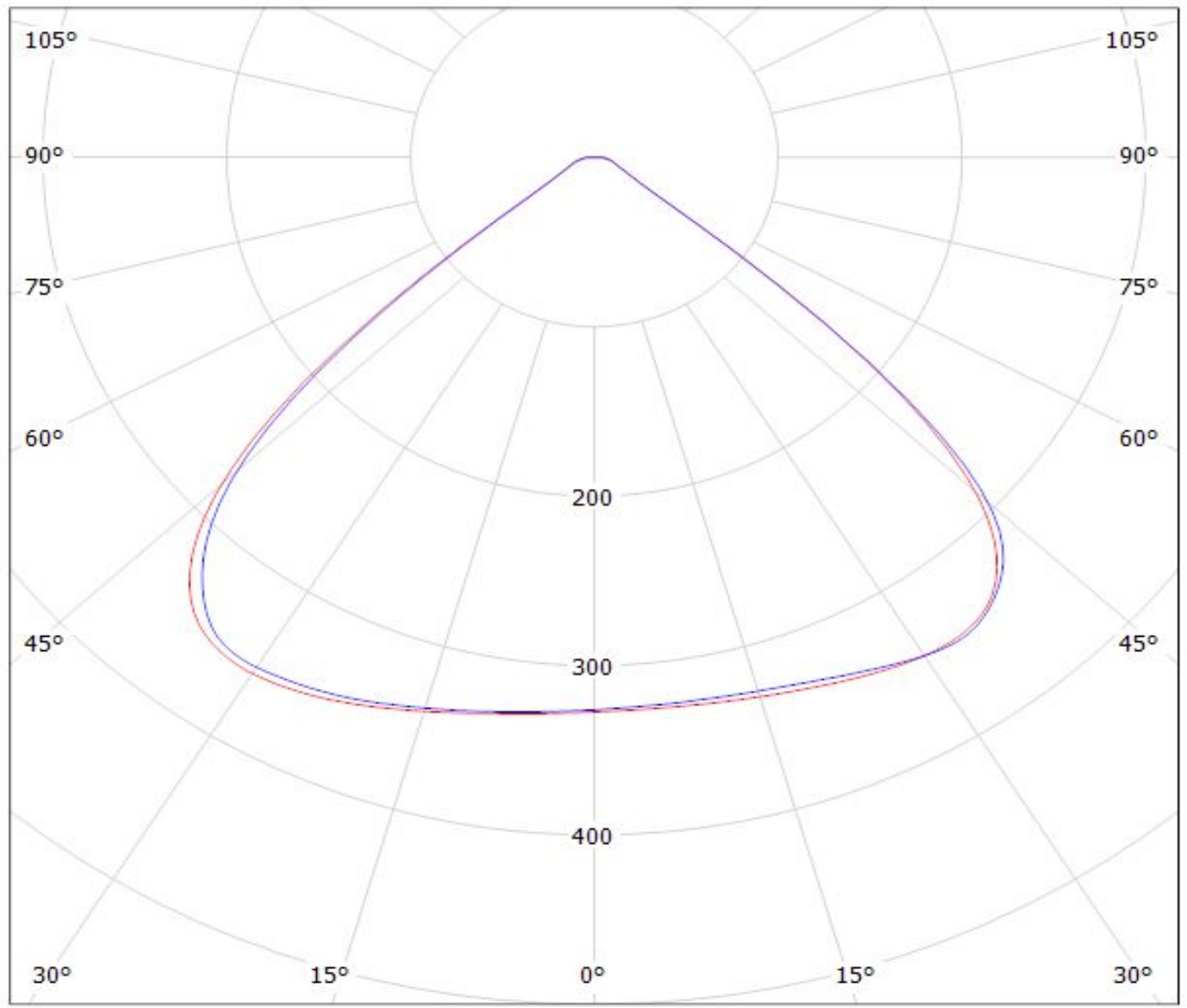

cd/klm

— C0 - C180 — C90 - C270

$\eta = 93\%$

Luminaire: LEDiL Oy F14531_JENNY-CY_(XM-L)

Lamps: 1 x CREE_XM-L_EZW_130.03lm@250mA_P=1.50385W_I=249.9mA

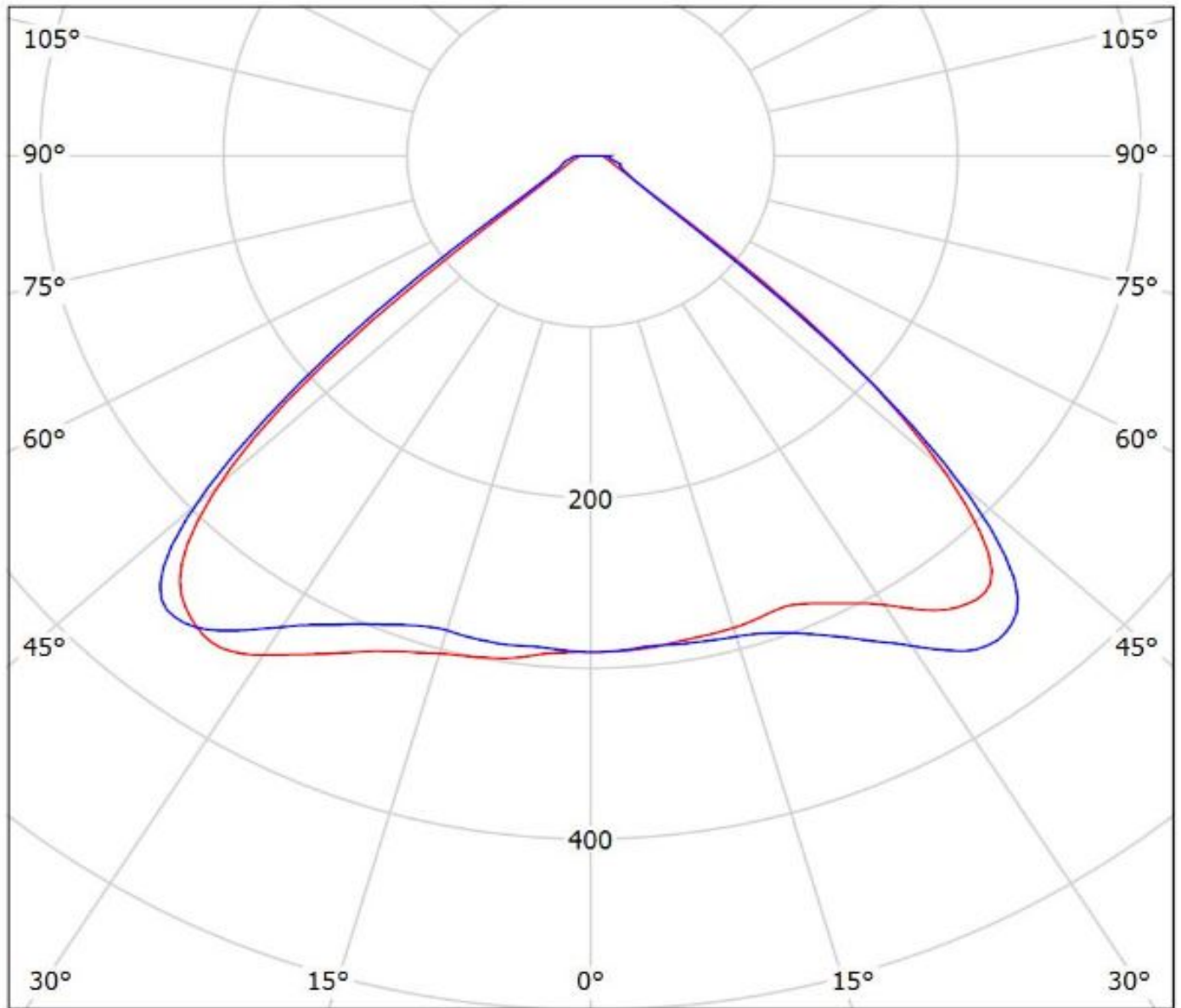

cd/klm

— C0 - C180

— C90 - C270

$\eta = 93\%$

Ledil F14531_JENNY-CY_(LUXEON_5258) / LDC (Polar)

Luminaire: Ledil F14531_JENNY-CY_(LUXEON_5258)

Lamps: 1 x LUXEON_5258_(24VOLTS)_307.573lm@100mA_CCT=2700K_P=?W_I=0.1A

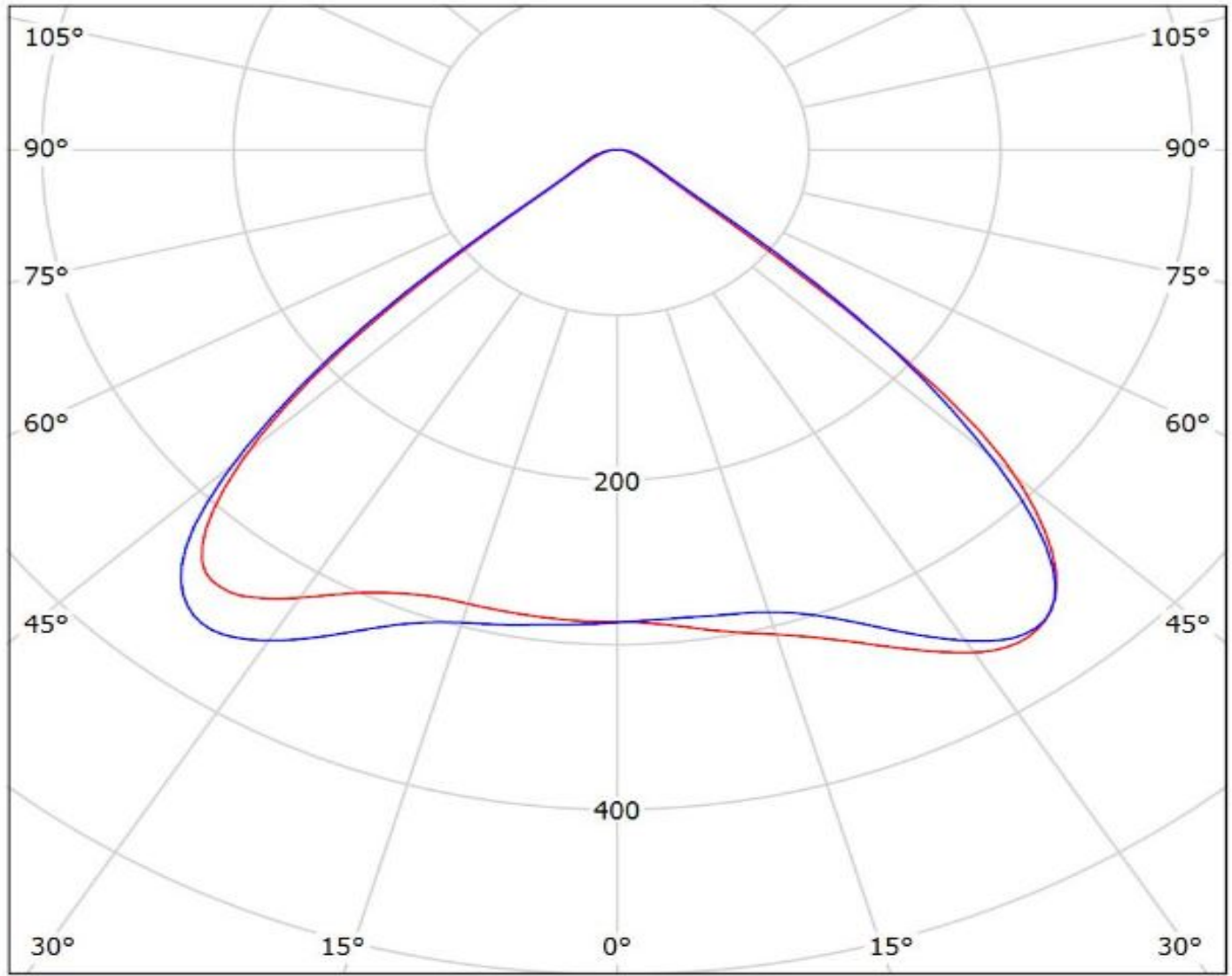

cd/klm
— C0 - C180 — C90 - C270

$\eta = 94\%$

Luminaire: LEDiL Oy F14531_JENNY-CY_(CLL010)
Lamps: 1 x CITIZEN_CLL010_(CLL010-0305A1-303M1A2)
_206.314lm@250mA_P=2.27184W_I=249.9mA

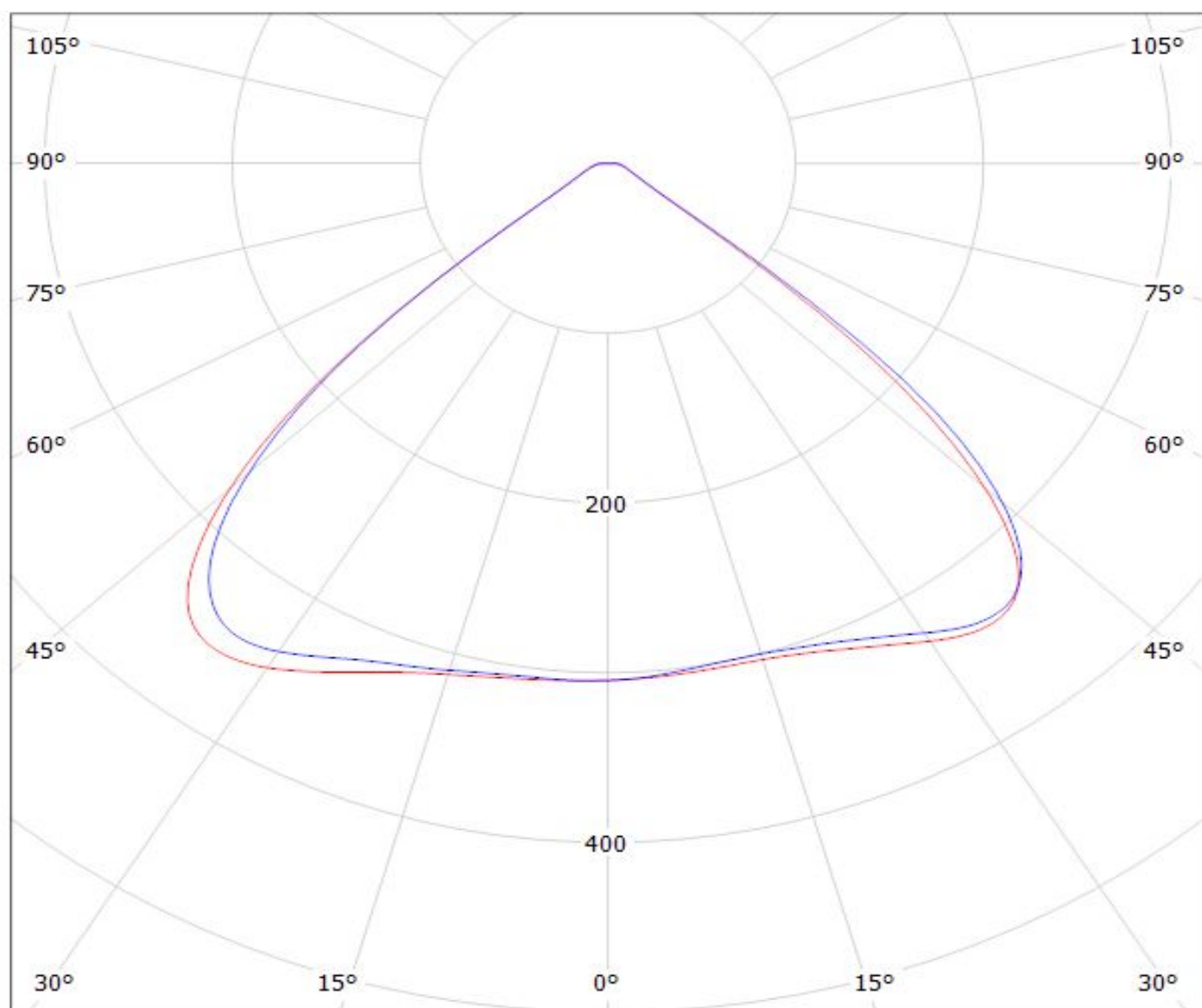

cd/klm

— C0 - C180

— C90 - C270

$\eta = 94\%$

Luminaire: LEDiL Oy F14531_JENNY-CY_(LUXEON_M)

Lamps: 1 x LUXEON_M_(LXR7-SW40)_318.732lm@250mA_P=2.72282W_I=249.8mA

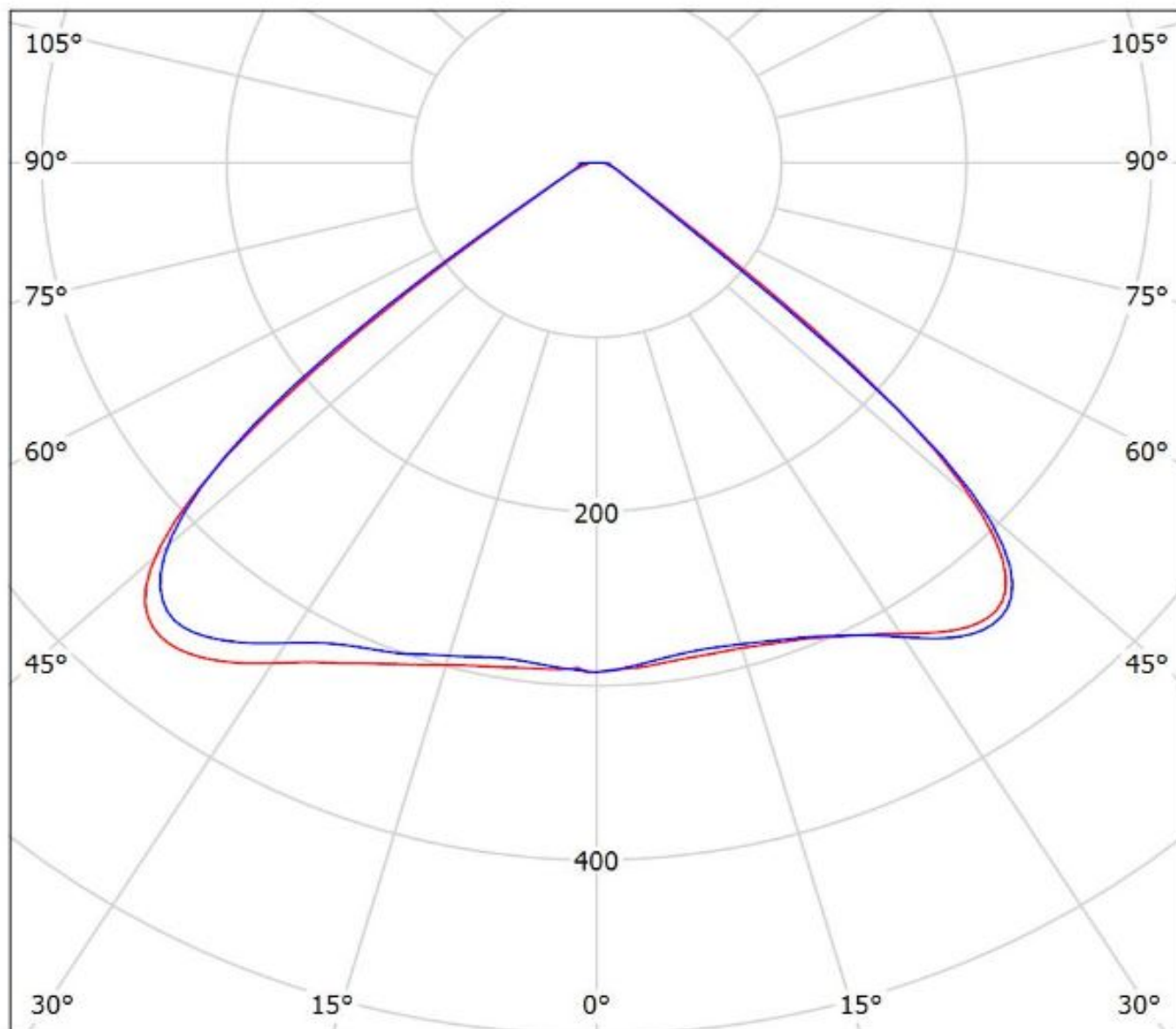

cd/klm

— C0 - C180 — C90 - C270

$\eta = 94\%$

Luminaire: LEDiL Oy F14531_JENNY-CY_(V8)

Lamps: 1 x BRIDGELUX_V8_871.869lm@250mA_P=8.88614W_I=249.8mA

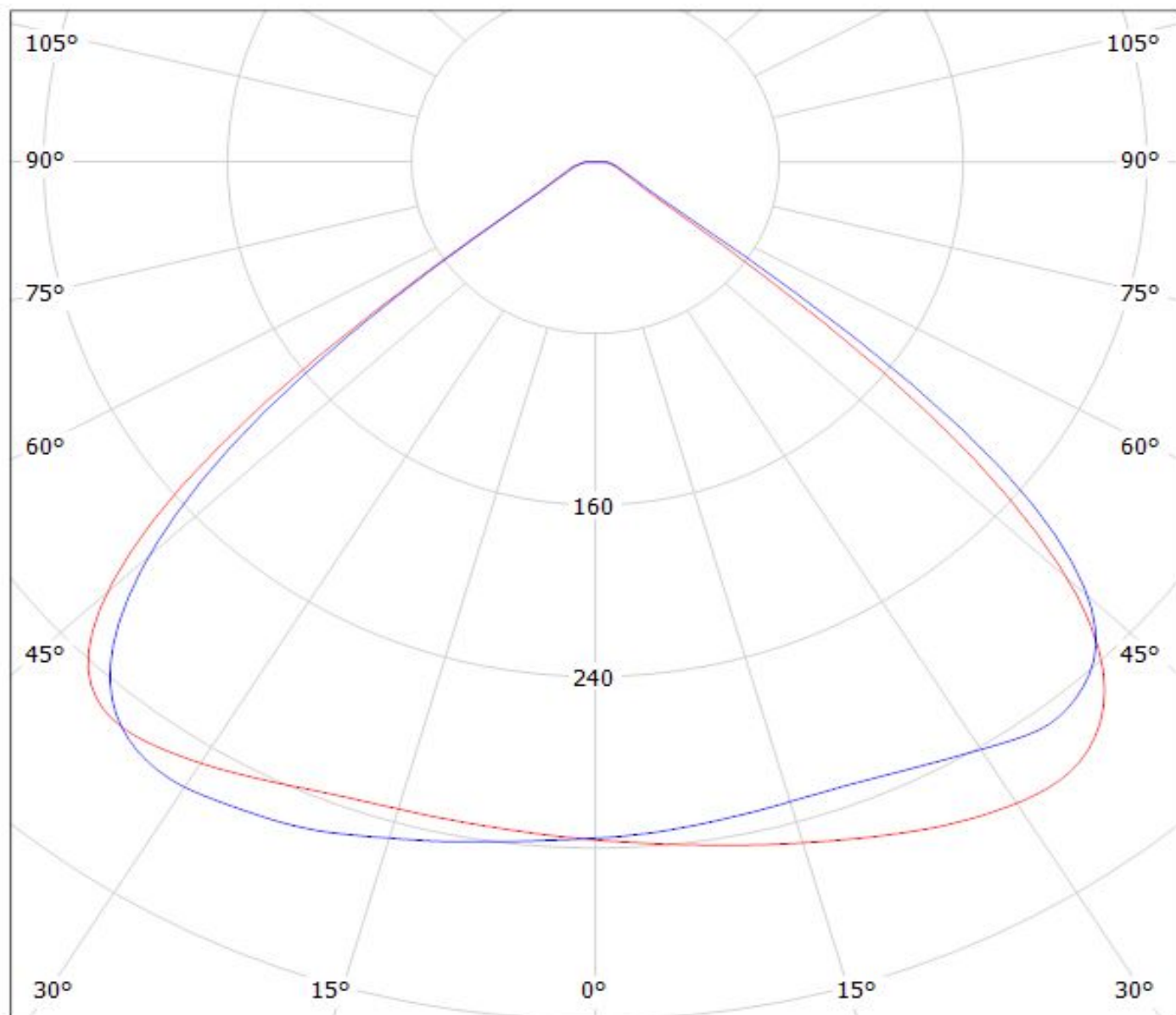

cd/klm

— C0 - C180

— C90 - C270

$\eta = 94\%$

Luminaire: LEDiL Oy F14531_JENNY-CY_(CXA1310)
Lamps: 1 x CREE_CXA1310_(CXA1310-30H-G4-F0Y-00001)
_367.9lm@250mA_CCT=3000K_P=4.22112W_I=249.8mA

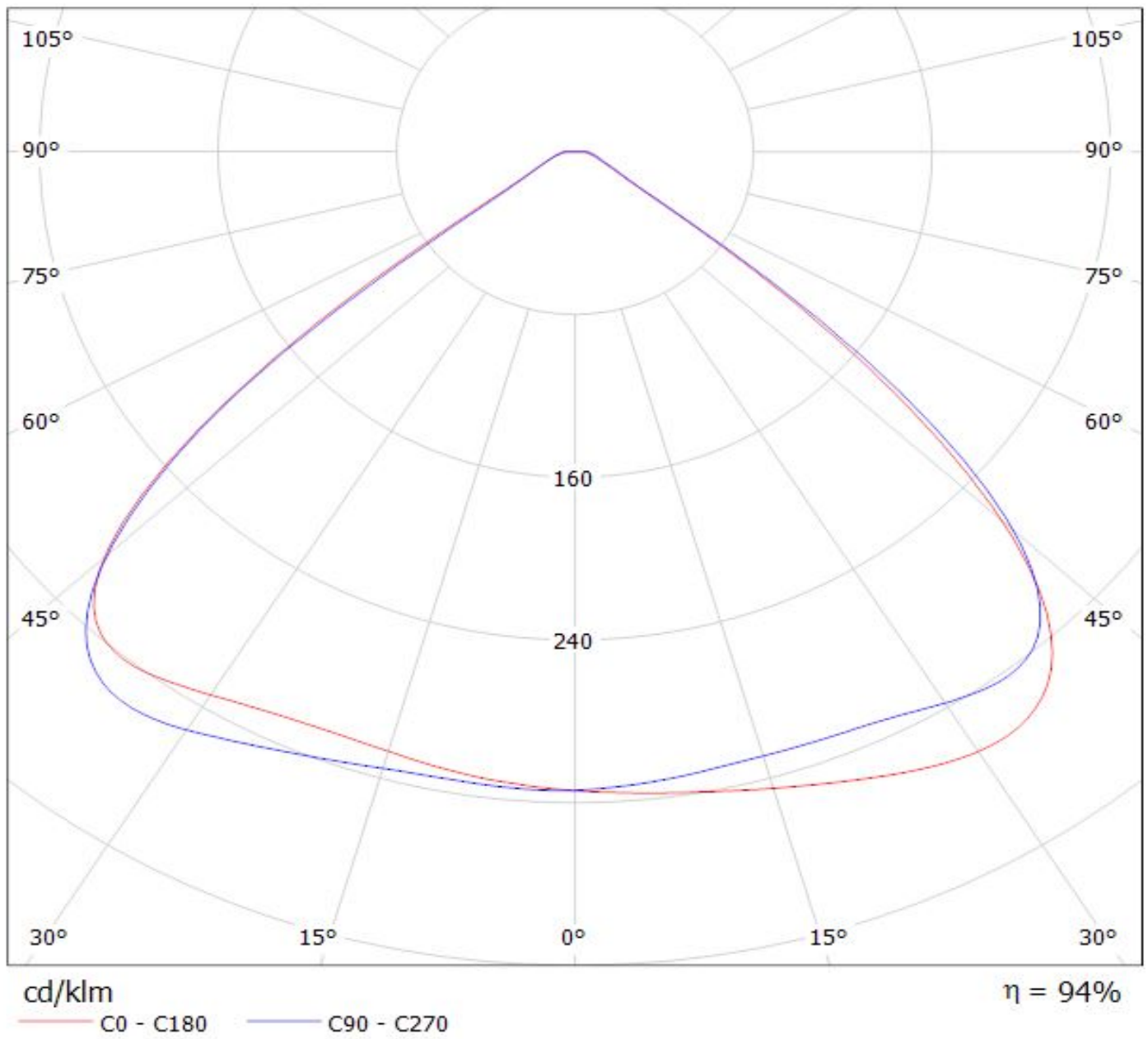

Luminaire: LEDiL Oy F14531_JENNY-CY_(NSMx286M)

Lamps: 1 x NICHIA_NSMx286M_(NSML286ME)_335.4lm@100mA_P=3.43543W_I=100.1mA

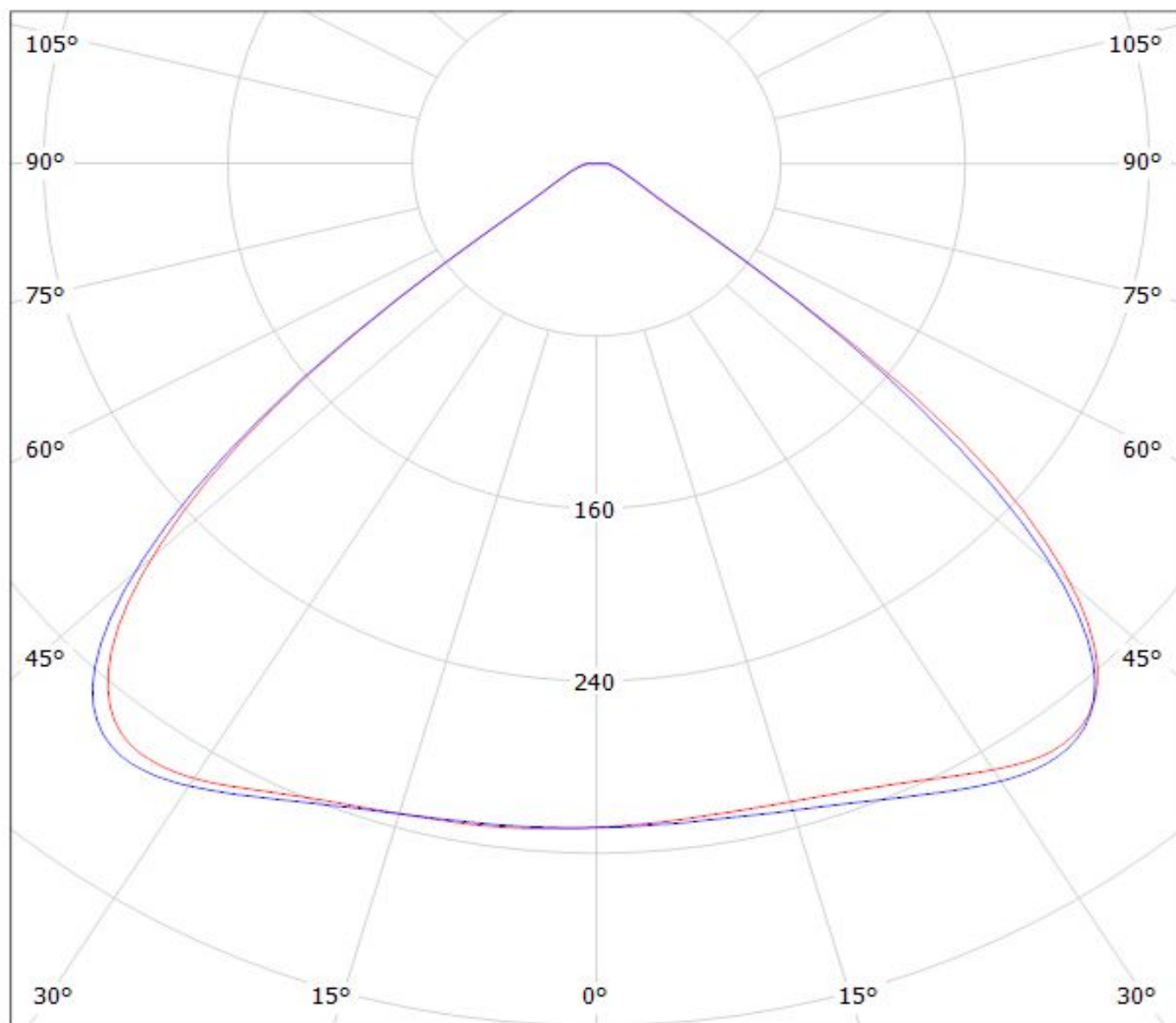

cd/klm

— C0 - C180

— C90 - C270

$\eta = 94\%$

Luminaire: LEDiL Oy F14531_JENNY-CY_(MK-R)

Lamps: 1 x MK-R_353.258lm@250mA_CCT=3276K_P=2.84836W_I=249.9mA

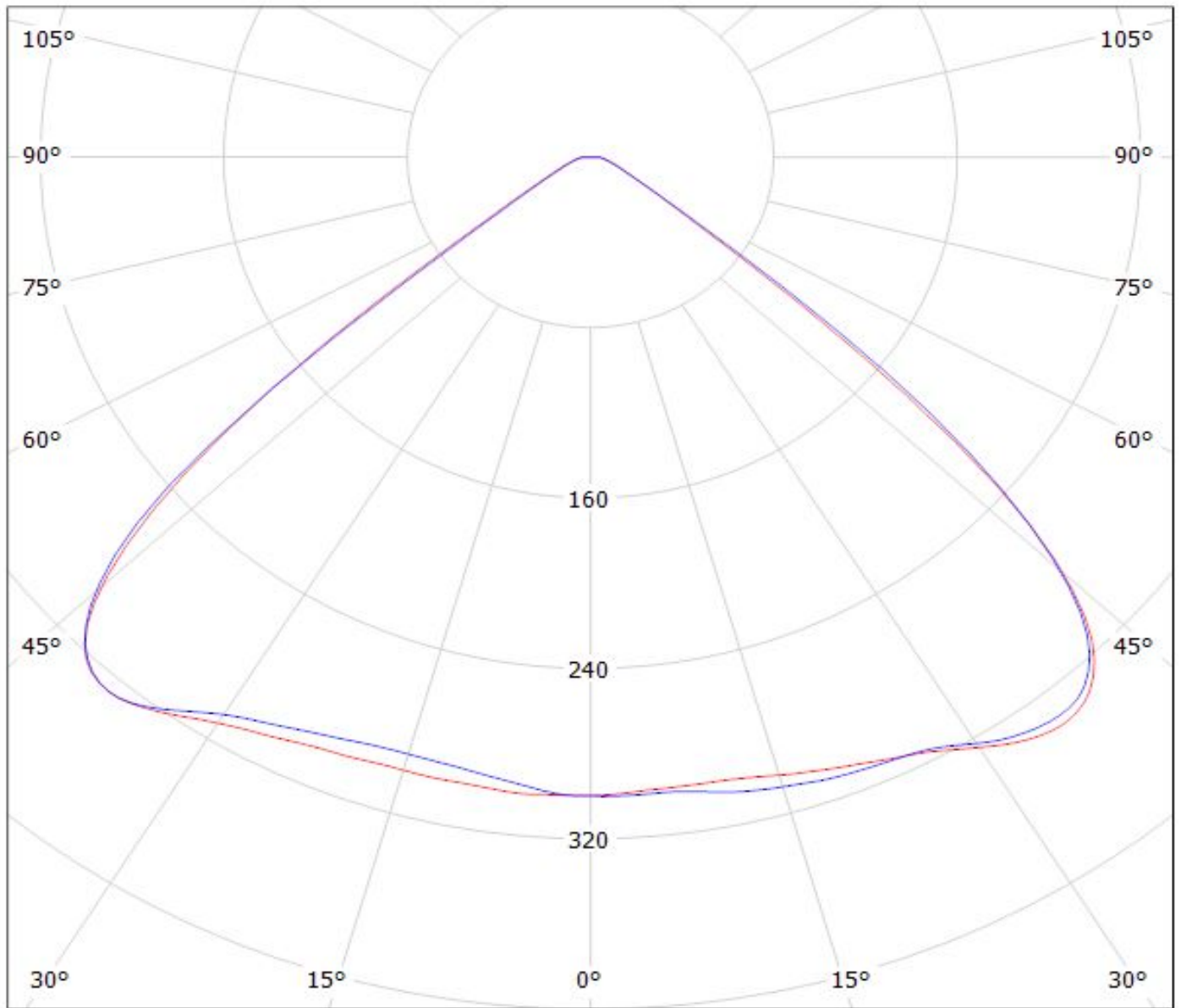

cd/klm

— C0 - C180

— C90 - C270

$\eta = 92\%$

Ledil F14531_JENNY-CY_(XHP50) / LDC (Polar)

Luminaire: Ledil F14531_JENNY-CY_(XHP50)

Lamps: 1 x XHP50_warm_white_210.85lm@250mA_P=1.4W_I=0.25A

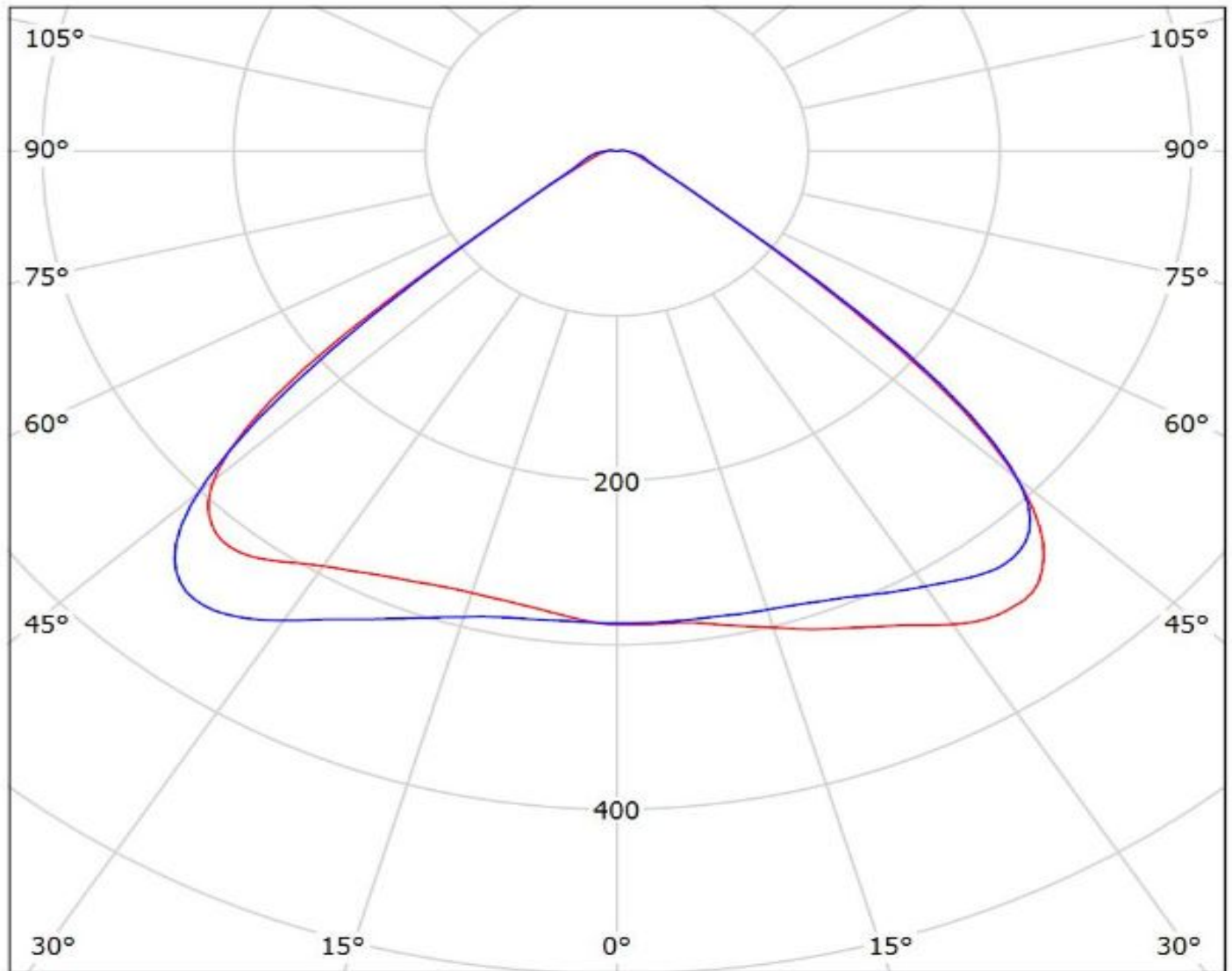

cd/klm

— C0 - C180 — C90 - C270

$\eta = 94\%$

Luminaire: LEDiL Oy F14531_JENNY-CY_(P9)

Lamps: 1 x OSRAM_SOLERIQ_P9_(GW_MAFJB1.EM)_911lm@250mA_P=6.90072W_I=249.8mA

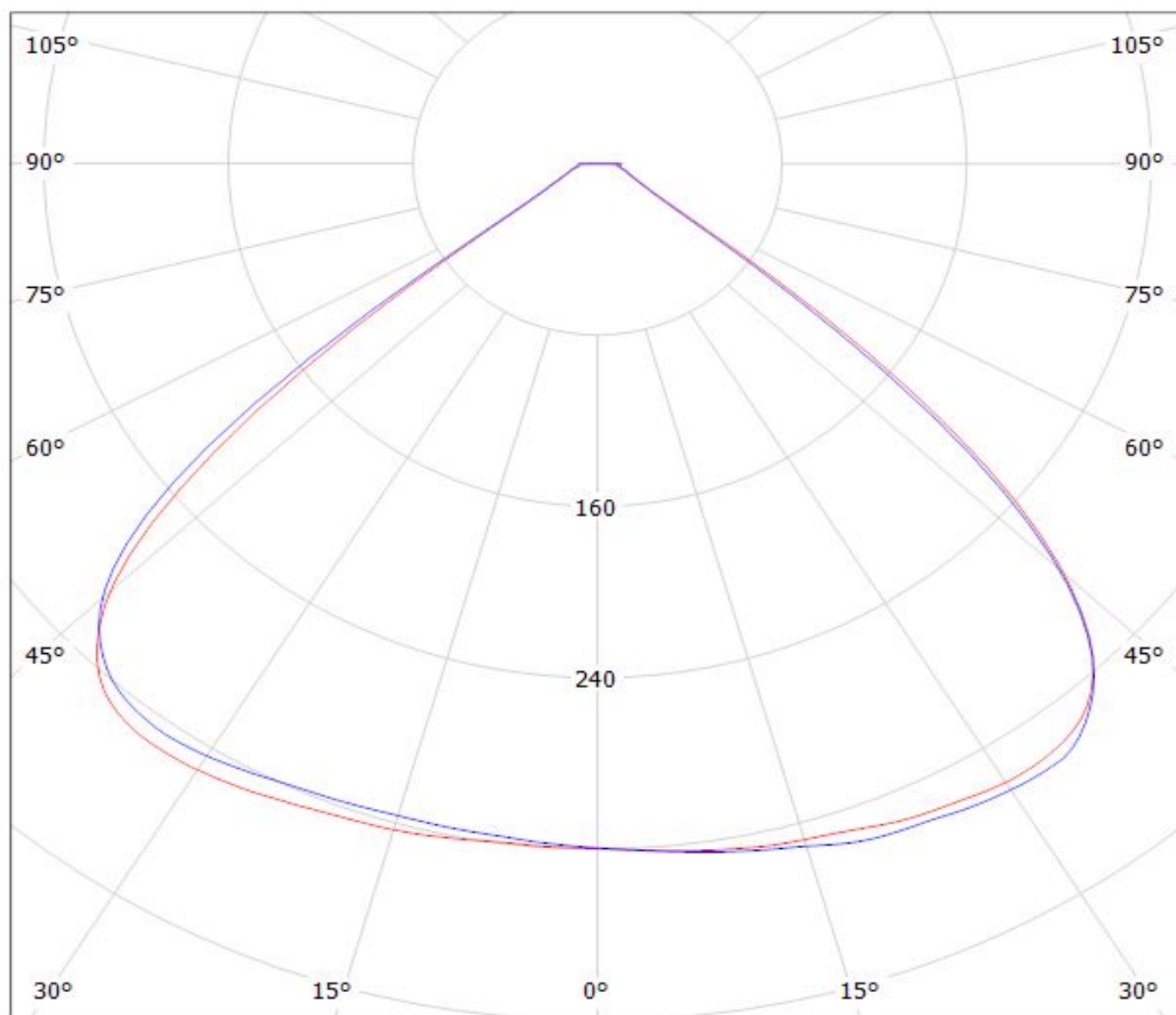

cd/klm

— C0 - C180

— C90 - C270

$\eta = 94\%$

Luminaire: LEDiL Oy F14531_JENNY-CY_(CXA1520)

Lamps: 1 x CREE_CXA1520_(CXA1520-30F-N4-N0H-0001)_976.326lm@250mA_U=8.36855W_I=249.8mA

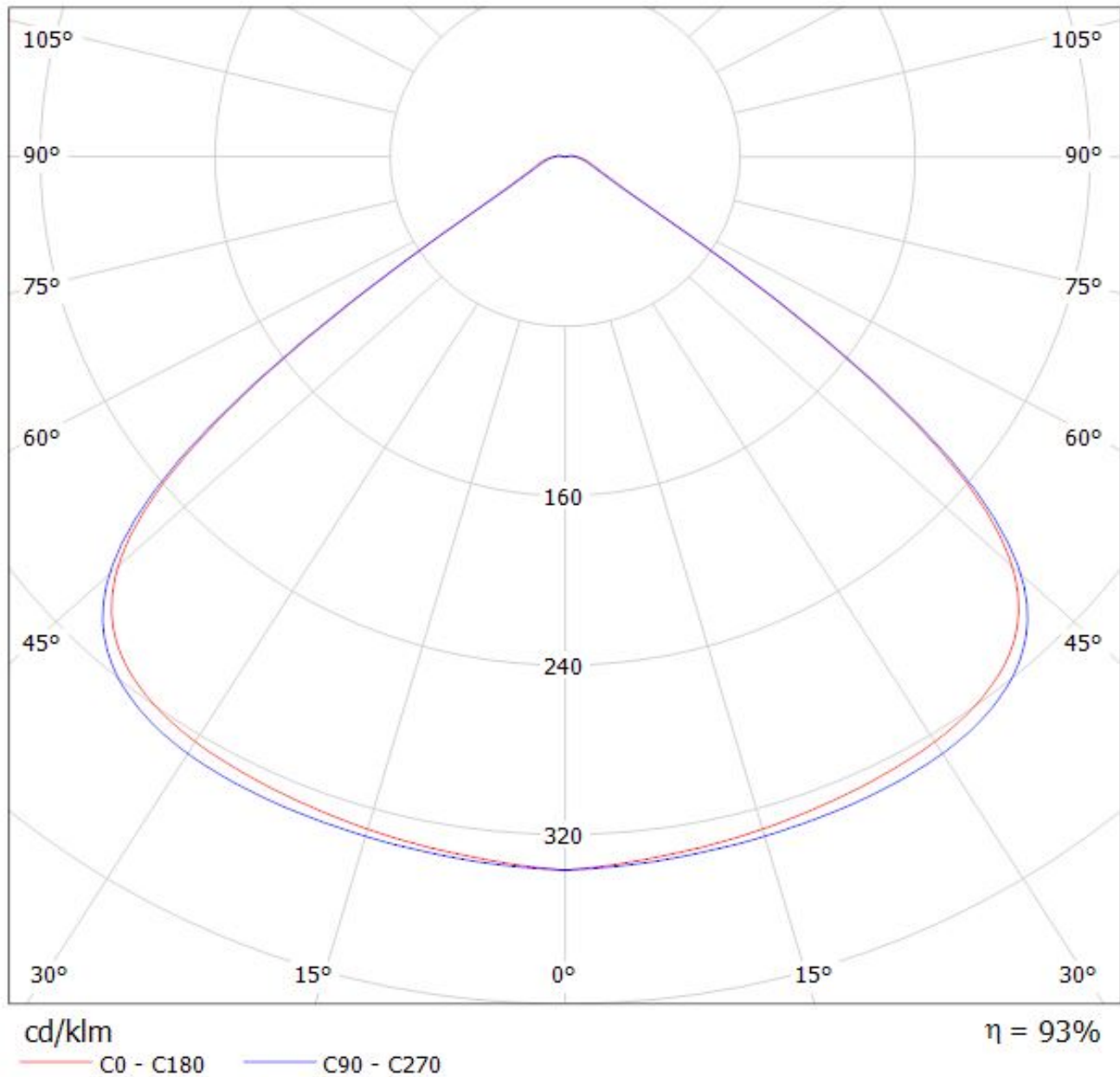

Luminaire: LEDiL Oy F14325_JENNY-8X1-CY_(P6)

Lamps: 1 x OSRAM_SOLERIQ_P6_(GW_MAFJB1.EM)_5550lm@250mA_P=48W_I=249.9mA

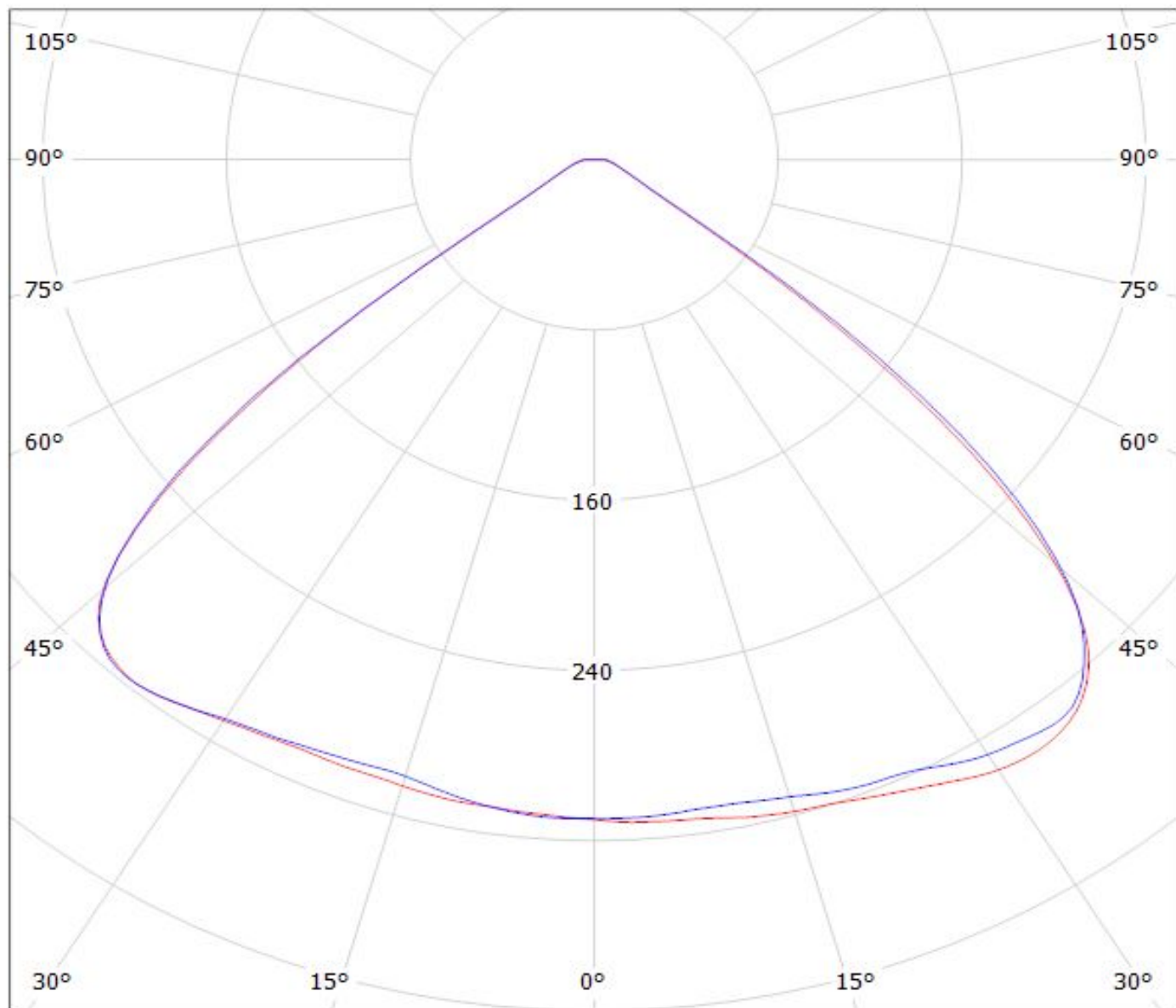

cd/klm

— C0 - C180

— C90 - C270

$\eta = 94\%$

Luminaire: LEDiL Oy F14531_JENNY-CY_(V6)

Lamps: 1 x BRIDGELUX_V6_447.582lm@250mA_P=5.15119W_I=249.9mA

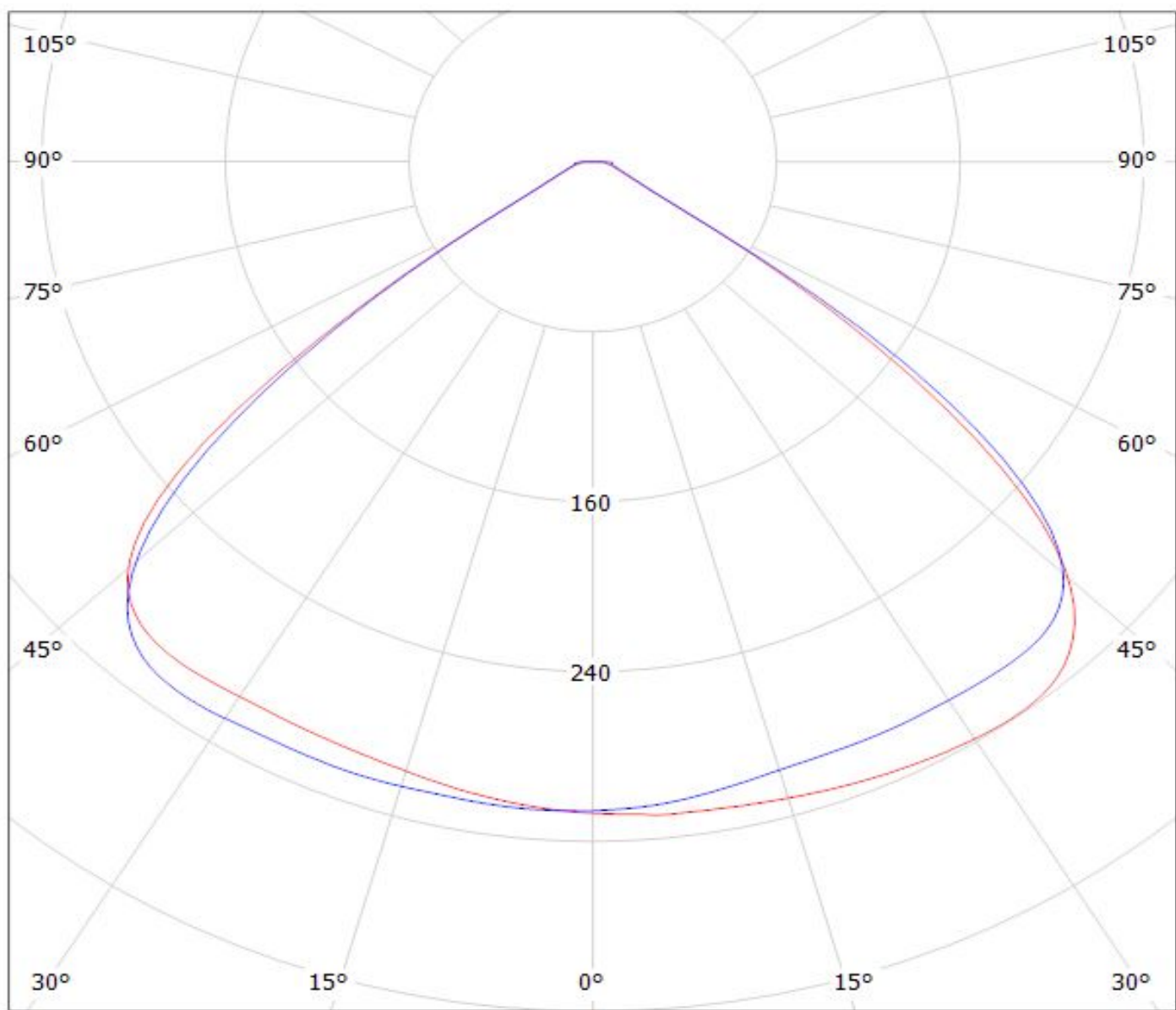

cd/klm

— C0 - C180

— C90 - C270

$\eta = 94\%$

NOTE: The typical divergence will be changed by different color, chip size and chip position tolerance. The typical total divergence is the full angle measured where the luminous intensity is half of the peak value.

GENERAL INFORMATION

- Product series especially designed & optimized for series of LEDs.
- Special care taken to make light distribution as uniform as possible.

Note! Due to use of high power COB's with this product, special attention to proper thermal design is highly recommended. LEDiL has no liability for direct, indirect or consecutive damages arising from the LEDiL products being used outside of the recommended temperature range.