

### ■ Dimensions

(Unit: mm)

**Recommended Soldering Pattern**

Note 1. The shaded portion in the above figure may cause shorting. Do not wire in this portion.  
 Note 2. The dimensional tolerance for the recommended soldering pattern is  $\pm 0.1$  mm.

**Internal Circuit**

Unless otherwise specified, the dimensional tolerance is  $\pm 0.15$  mm.

Terminal No.	Name
A	Anode
K	Cathode
C	Collector
E	Emitter

### ■ Features

- Ultra-compact model.
- PCB surface mounting type.

### ■ Absolute Maximum Ratings (Ta=25°C)

Item		Symbol	Rated value	Unit
Emitter	Forward current	IF	50 <sup>*1</sup>	mA
	Reverse voltage	VR	6	V
Detector	Collector-Emitter voltage	VCEO	35	V
	Emitter-Collector voltage	VECO	6	V
	Collector current	IC	20	mA
	Collector dissipation	PC	75 <sup>*1</sup>	mW
Total allowable loss		Ptot	100 <sup>*1</sup>	mW
Operating temperature		Topr	-25 to 85	°C
Storage temperature		Tstg	-40 to 100	°C
Soldering temperature		Tsol	260 <sup>*2</sup>	°C

- \*1. Refer to the temperature rating chart if the ambient temperature exceeds 25°C.  
 \*2. Complete soldering within 5 seconds.  
 For reflow soldering, use the conditions given on page 4.

### ■ Electrical and Optical Characteristics (Ta=25°C)

Item	Symbol	Value			Unit	Condition	
		MIN.	TYP.	MAX.			
Emitter	Forward current	V <sub>F</sub>	---	1.2	1.4	V	I <sub>F</sub> = 20mA
	Reverse voltage	I <sub>R</sub>	---	---	10	μA	VR = 6V
	Peak emission wavelength	λ <sub>P</sub>	---	950	---	nm	---
Detector	Light current	I <sub>L</sub>	40	85	130	μA	I <sub>F</sub> = 4 mA, V <sub>CE</sub> = 2V, Aluminum-deposited surface, d = 1 mm*
	Dark current	I <sub>D</sub>	---	1	100	nA	V <sub>CE</sub> = 20V, 0lx
	Leakage current	I <sub>LEAK</sub>	---	---	500	nA	I <sub>F</sub> = 4mA, V <sub>CE</sub> = 2V, with no reflection
	Collector-Emitter saturated voltage	V <sub>CE (sat)</sub>	---	---	---	V	---
	Peak spectral sensitivity wavelength	λ <sub>P</sub>	---	930	---	nm	---
Rising time	t <sub>r</sub>	---	20	100	μA	V <sub>CC</sub> = 2 V, R <sub>L</sub> = 1 kΩ, I <sub>L</sub> = 100 μA, d = 1 mm*	
Falling time	t <sub>f</sub>	---	20	100	μA	V <sub>CC</sub> = 2 V, R <sub>L</sub> = 1 kΩ, I <sub>L</sub> = 100 μA, d = 1 mm*	

\* Refer to Fig 12. Light Current Measurement Setup Diagram on page 2.

Engineering Data

Fig 1. Forward Current vs. Collector Dissipation Temperature Rating

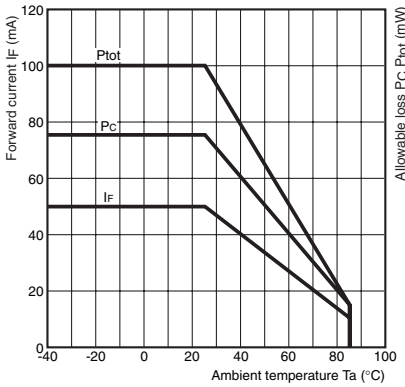

Fig 4. Light Current vs. Collector-Emitter Voltage Characteristics (Typical)

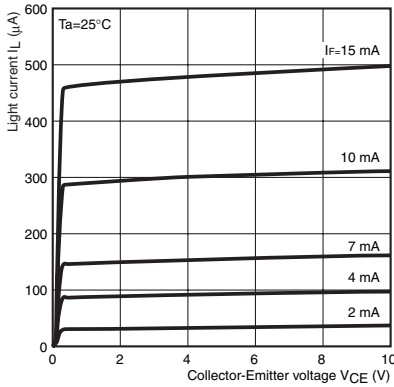

Fig 7. Response Time vs. Load Resistance Characteristics (Typical)

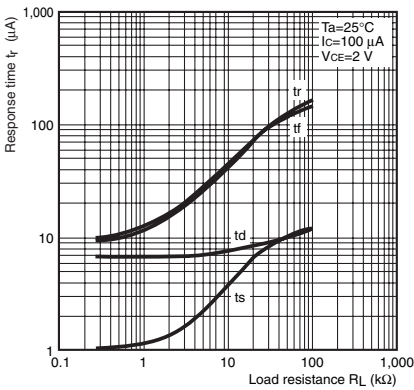

Fig 10. Relative Light Current vs. Card Moving Distance Characteristics (Typical)

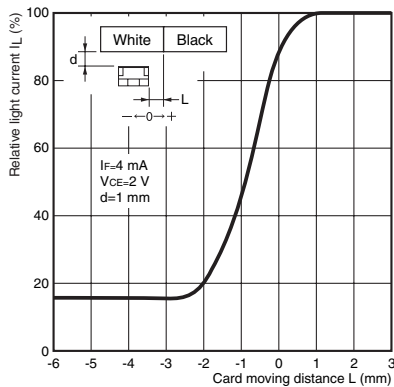

Fig 2. Forward Current vs. Forward Voltage Characteristics (Typical)

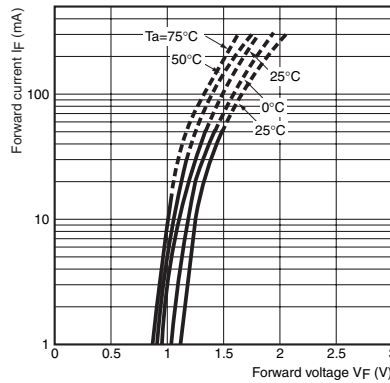

Fig 5. Relative Light Current vs. Ambient Temperature Characteristics (Typical)

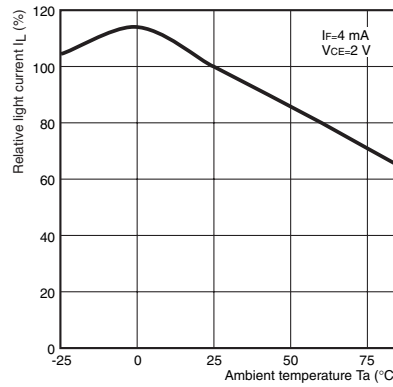

Fig 8. Relative Light Current vs. Distance Characteristics (Typical)

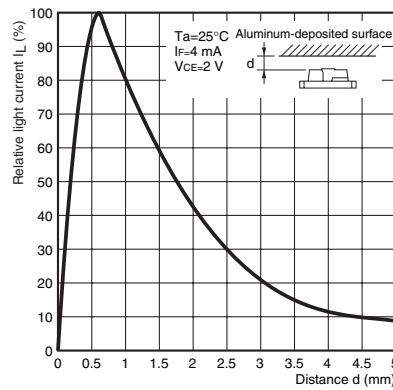

Fig 11. Response Time Measurement Circuit

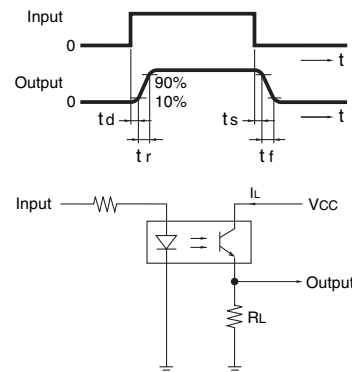

Fig 3. Light Current vs. Forward Current Characteristics (Typical)

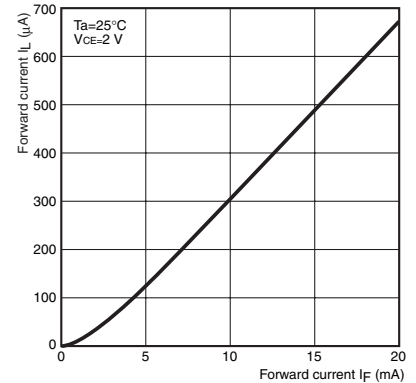

Fig 6. Dark Current vs. Ambient Temperature Characteristics (Typical)

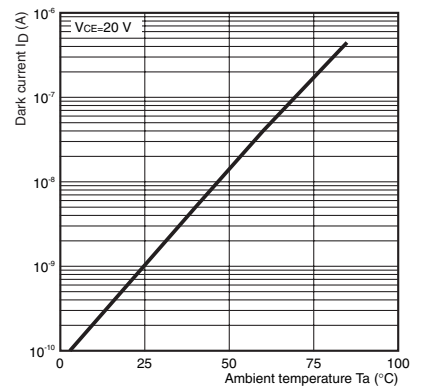

Fig 9. Relative Light Current vs. Card Moving Distance Characteristics (Typical)

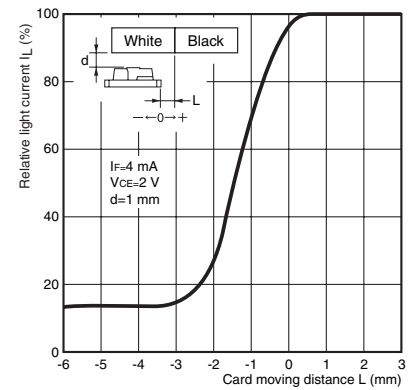
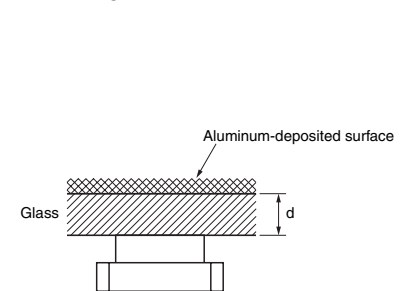

Fig 12. Light Current Measurement Setup Diagram



# EE-SY199

## ■ Tape and Reel

### ● Reel Dimension (Unit: mm)

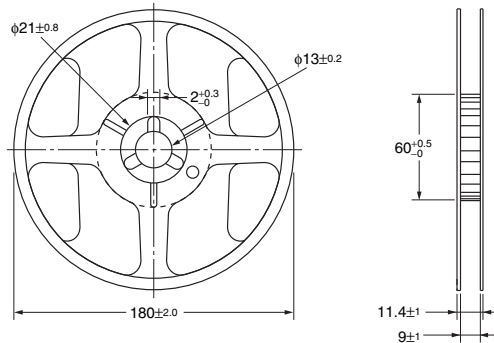

### ● Tape Dimension (Unit: mm)

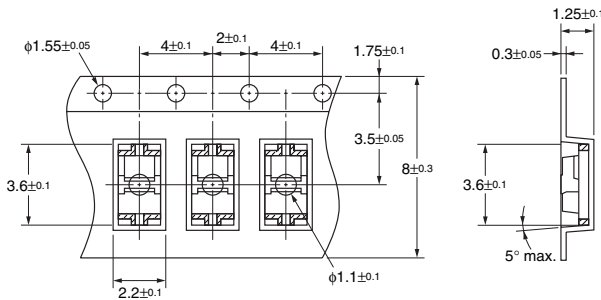

### ● Part Mounting Direction

- The devices are oriented in the rectangular holes in the carrier tape so that the edge with the LED faces the round feeding holes.

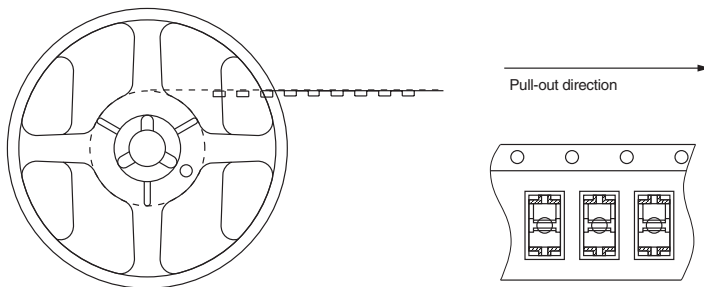

### ● Tape Quantity

2,000 pcs./reel

### ● Packing Specifications

- One reel is sealed in an aluminum-laminated bag.
- The model number, lot number, and quantity are given on the label.

**■ Precautions**

**● Temperature Profile**

The reflow soldering must be completed in one time and must comply with the following diagram.

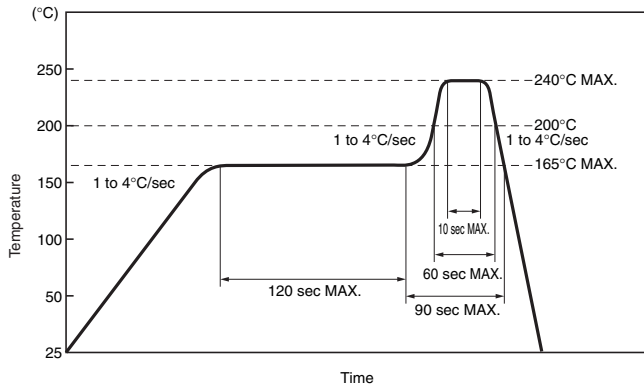

**● Solder Quantity**

The pin's wiring pattern between the package and the board must not be soldered. Doing so would result in damage to the product's reliability. Make sure to adjust the solder quantity to the product sidewall of the terminal.

**● Other Precautions**

- The use of an infrared lamp causes the temperature of the resin to rise partially too high.
- Do not immerse the resin part into the solder.
- Test the soldering method under actual conditions and make sure the soldering works fine, since the impact on the junction between the device and PCB varies depending on the cooling and soldering conditions.

**■ Storage and Handling after Opening**

**● Storage Conditions**

Store the product under the following conditions:

- Temperature: 5 to 30°C
- Humidity: 70% max.

**● Treatment after Opening**

After opening the bag, store the products between 5 and 25°C at 60% humidity or lower and mount them within two days.

If storage for longer than two days after opening the bag is required, use a dry box or reseal the products in a moisture-proof bag with a commercially available desiccant. Store them between 5 and 30°C at 70% humidity or lower, and mount them within two weeks.

**● Baking before Mounting**

If the above treatment could not be carried out, mounting is still possible after baking treatment. However, baking treatment must be limited to only one time.

Recommended conditions: 125°C, 16 to 24 hours

Note: Do not bake the products while they are still in the bag. Temporarily mount them to the PCB or place them in metal trays.

**● Cleaning Conditions**

Cleaning in Solvent:

- Solvent temperature: 45°C max.
- Immersion time: 3 hours max.

Ultrasonic Cleaning:

Do not use ultrasonic cleaning.

Recommended Solvents:

Ethyl alcohol, methyl alcohol, or isopropyl alcohol