

Photomicrosensor (Reflective) EE-SY169B

⚠ Be sure to read Precautions on page 25.

■ Dimensions

Note: All units are in millimeters unless otherwise indicated.

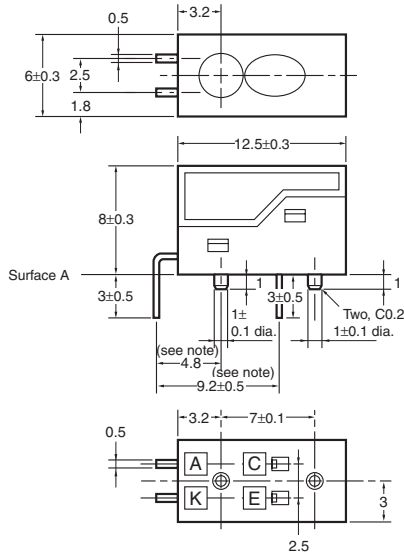

Internal Circuit

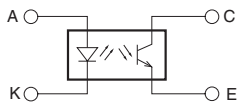

Note: These dimensions are for the surface A. Other lead wire pitch dimensions are for the housing surface.

Unless otherwise specified, the tolerances are as shown below.

Dimensions	Tolerance
3 mm max.	±0.3
3 < mm ≤ 6	±0.375
6 < mm ≤ 10	±0.45
10 < mm ≤ 18	±0.55
18 < mm ≤ 30	±0.65

Terminal No.	Name
A	Anode
K	Cathode
C	Collector
E	Emitter

■ Features

- High-quality model with plastic lenses.
- Highly precise sensing range with a tolerance of ±0.6 mm horizontally and vertically.
- With a red LED sensing dyestuff-type links.
- Limited reflective model
- Higher gain than EE-SY169.
- Possible to get the same I_L as EE-SY169 with $I_F=10$ mA. (half of EE-SY169 condition)

■ Absolute Maximum Ratings (Ta = 25°C)

Item	Symbol	Rated value
Emitter	Forward current	I_F 40 mA (see note 1)
	Pulse forward current	I_{FP} 300 mA (see note 2)
	Reverse voltage	V_R 3 V
Detector	Collector–Emitter voltage	V_{CEO} 30 V
	Emitter–Collector voltage	V_{ECO} ---
	Collector current	I_C 20 mA
	Collector dissipation	P_C 100 mW (see note 1)
Ambient temperature	Operating	T_{opr} 0°C to 70°C
	Storage	T_{stg} -20°C to 80°C
Soldering temperature	T_{sol} 260°C (see note 3)	

- Note:**
1. Refer to the temperature rating chart if the ambient temperature exceeds 25°C.
 2. The pulse width is 10 μs maximum with a frequency of 100 Hz.
 3. Complete soldering within 10 seconds.

■ Electrical and Optical Characteristics (Ta = 25°C)

Item	Symbol	Value	Condition
Emitter	Forward voltage	V_F 1.85 V typ., 2.3 V max.	$I_F = 20$ mA
	Reverse current	I_R 0.01 μA typ., 10 μA max.	$V_R = 3$ V
	Peak emission wavelength	λ_P 660 nm typ.	$I_F = 20$ mA
Detector	Light current	I_L 160 μA min., 2,000 μA max.	$I_F = 10$ mA, $V_{CE} = 5$ V White paper with a reflection ratio of 90%, $d = 4$ mm (see note)
	Dark current	I_D 2 nA typ., 200 nA max.	$V_{CE} = 5$ V, 0 lx
	Leakage current	I_{LEAK} 2 μA max.	$I_F = 20$ mA, $V_{CE} = 5$ V with no reflection
	Collector–Emitter saturated voltage	$V_{CE} (sat)$ ---	---
	Peak spectral sensitivity wavelength	λ_P 850 nm typ.	$V_{CE} = 5$ V
Rising time	t_r 30 μs typ.	$V_{CC} = 5$ V, $R_L = 1$ kΩ, $I_L = 1$ mA	
Falling time	t_f 30 μs typ.	$V_{CC} = 5$ V, $R_L = 1$ kΩ, $I_L = 1$ mA	

Note: The letter “d” indicates the distance between the top surface of the sensor and the sensing object.

Engineering Data

Forward Current vs. Collector Dissipation Temperature Rating

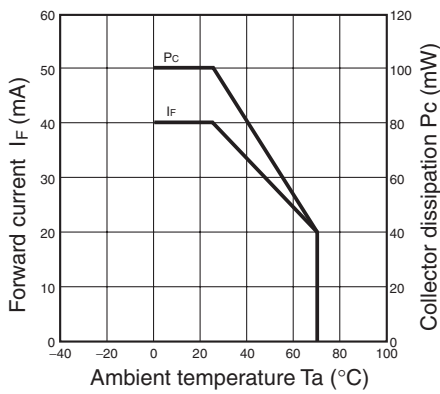

Light Current vs. Forward Current Characteristics (Typical)

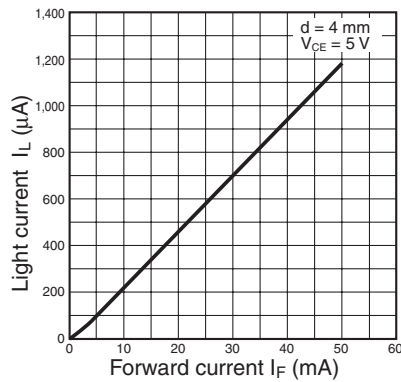

Light Current vs. Collector-Emitter Voltage Characteristics (Typical)

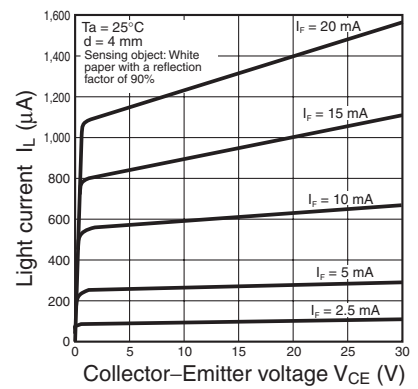

Relative Light Current vs. Ambient Temperature Characteristics (Typical)

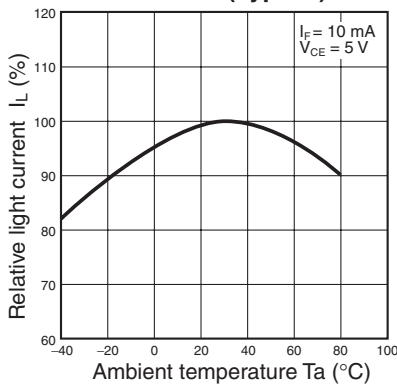

Dark Current vs. Ambient Temperature Characteristics (Typical)

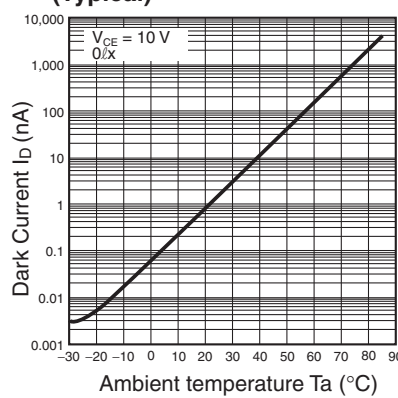

Response Time vs. Load Resistance Characteristics (Typical)

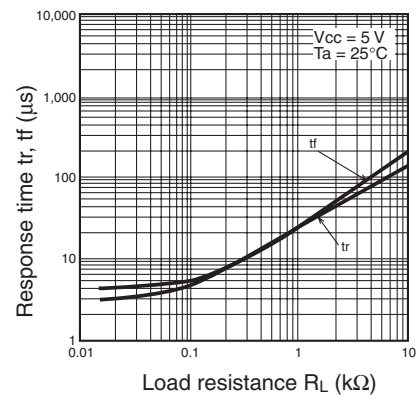

Sensing Distance Characteristics (Typical)

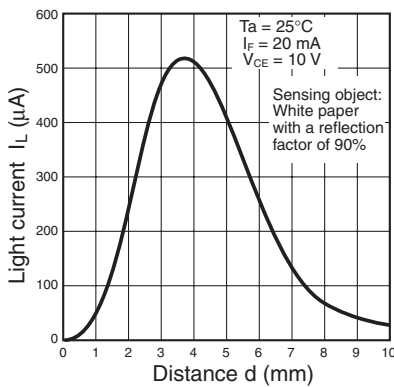

Sensing Position Characteristics (Typical)

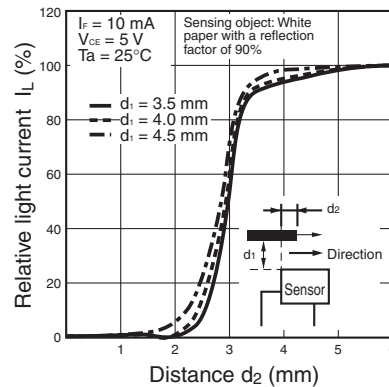

Sensing Position Characteristics (Typical)

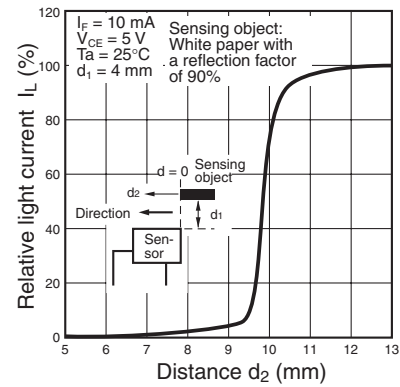

Sensing Angle Characteristics (Typical)

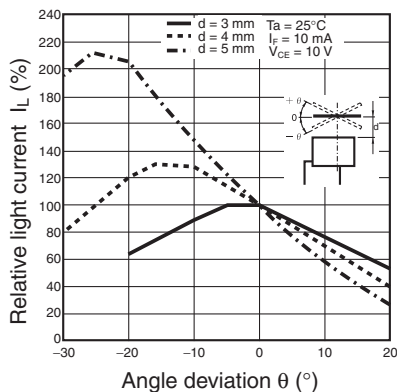

Sensing Angle Characteristics (Typical)

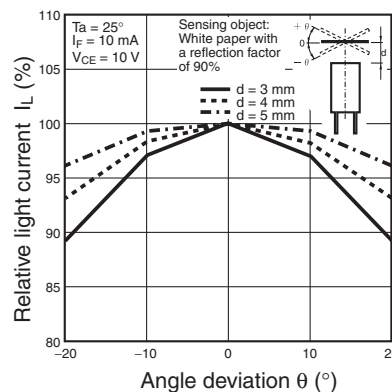

Response Time Measurement Circuit

