

motor with gear motorreductor

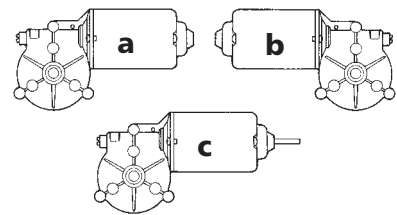

Reference number Referencia	Nominal voltage Tensión nominal	Nominal torque Par nominal	Nominal speed Velocidad nominal	Nominal current Corriente nominal	Starting torque Par de arranque	Starting current Corriente de Arranque	Shaft Eje	Connections Conexiones	Wiring diag. Esq. elect.	Transmission ratio Relación de reducción	Approximate weight Peso aproximado	Watertightness Grado de estanqueidad	Wheel material Material rueda	Design: a.b.c Diseño: a.b.c	Curve Curva
	Un (V)	Mn (N.m. / lbf.in)	nn (r.p.m.)	In (A)	Ma (N.m. / lbf.in)	Ia (A)				i	P (kg / lb.t)	IP			
111.3711.20.00	12	5 / 44.2	40	5	25 / 221.2	25	E22	C25	EE2	62:1	1.25 / 3.34	IP53	PLA	a	1
111.3711.30.00	24	5 / 44.2	40	2.5	25 / 221.2	13	E22	C25	EE2	62:1	1.25 / 3.34	IP53	PLA	a	1
111.3761.20.00	12	5 / 44.2	40	5	25 / 221.2	25	E23	C25	EE2	62:1	1.25 / 3.34	IP53	PLA	a	1
111.3761.30.00	24	5 / 44.2	40	2.5	25 / 221.2	13	E23	C25	EE2	62:1	1.25 / 3.34	IP53	PLA	a	1
111.3761.20.00E	12	5 / 44.2	40	5	25 / 221.2	25	E23	C25	F2	62:1	1.25 / 3.34	IP53	PLA	a	1
111.3761.30.00E	24	5 / 44.2	40	2.5	25 / 221.2	13	E23	C25	F2	62:1	1.25 / 3.34	IP53	PLA	a	1
111.3763.20.00	12	6 / 53.1	25	4	25 / 221.2	15	E23	C25	EE2	62:1	1.25 / 3.34	IP53	PLA	a	3
111.3763.30.00	24	6 / 53.1	25	2	25 / 221.2	8	E23	C25	EE2	62:1	1.25 / 3.34	IP53	PLA	a	3
111.4761.30.00	24	5 / 44.2	40	2.5	25 / 221.2	13	E23	C25	EE2	62:1	1.25 / 3.34	IP53	PLA	b	1
111.9031.20.00	12	3 / 26.5	70	6	25 / 221.2	34	E23	C25	EE2	62:1	1.25 / 3.34	IP53	PLA	a	2
111.9031.30.00	24	3 / 26.5	70	3	25 / 221.2	17	E23	C25	EE2	62:1	1.25 / 3.34	IP53	PLA	a	2
111.9039.30.00	24	1.5 / 13.2	240	4	14 / 123.9	23	E23	C26	EE1	49:4	1.25 / 3.34	IP53	PLA	a	4
111.9041.30.00	24	5 / 44.2	40	2.5	25 / 221.2	13	E24	C25	EE2	62:1	1.30 / 3.48	IP53	BRO	a	1
111.9094.20.00	12	5 / 44.2	40	5	25 / 221.2	25	E52	C2	EE2	62:1	1.25 / 3.34	IP53	PLA	a	1
111.9107.30.00	24	1.5 / 13.2	240	4	14 / 123.9	23	E24/E53	C26	EE1	49:4	1.25 / 3.34	IP40	CEL	c	4
111.9114.30.00	24	3 / 26.5	70	3	25 / 221.2	17	E24/E54	C37	EE2	62:1	1.25 / 3.34	IP40	PLA	c	2
111.9199.30.00	24	3 / 26.5	100	3	20 / 177.01	24	E24	C26	F3	59:2	1.25 / 3.34	IP53	PLA	a	59

DOGA can develop for you on this series a customised version:
 DOGA puede desarrollar para usted una versión a medida:

▼

SELF-LOCKING / AUTO-BLOQUEO
BRONZE WHEEL / RUEDA DE BRONCE
RESINBONDED WHEEL / RUEDA DE CELOTEX
FRONT & REAR SHAFT / EJE DELANTERO Y POSTERIOR
HALL SENSOR / SENSOR HALL

▲

and many more / y mucho más
 please contact us / por favor contactenos

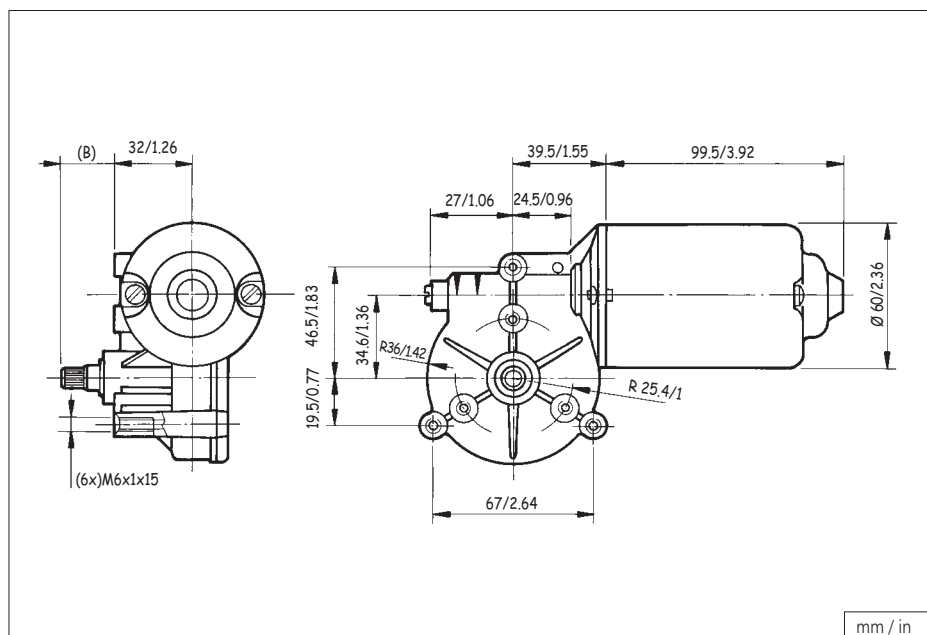

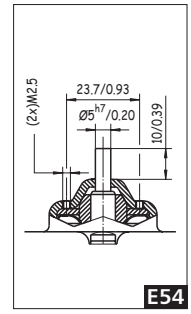
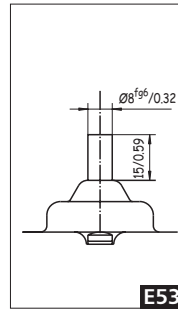
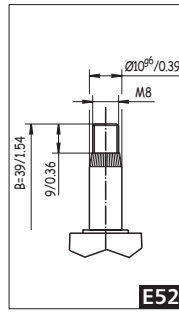
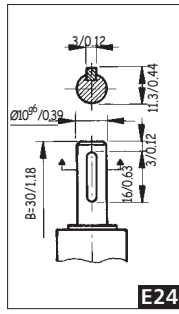
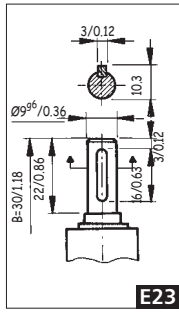
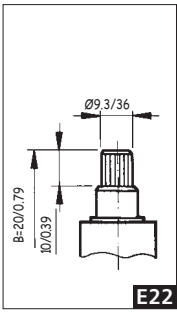

111

CONNECTION - CONEXIÓN

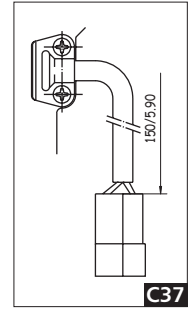
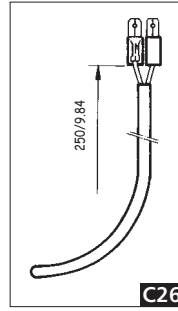
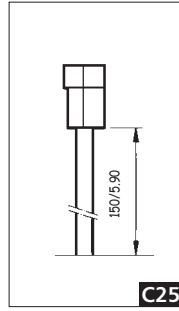
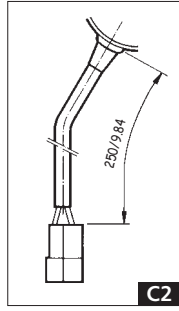

119

210

258

WIRING DIAGRAM - ESQUEMA ELÉCTRICO

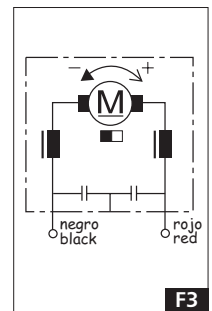
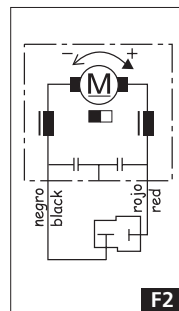
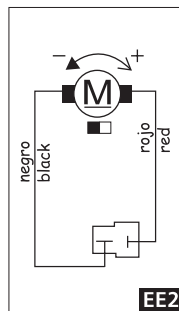
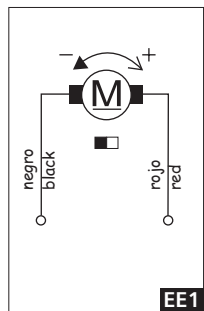

259

316

319

CURVES - CURVAS

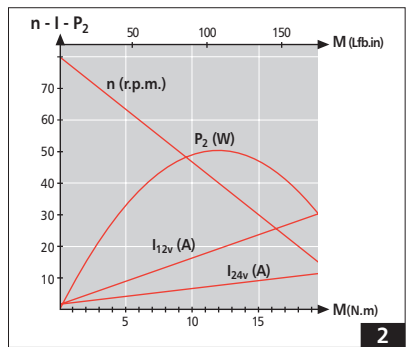
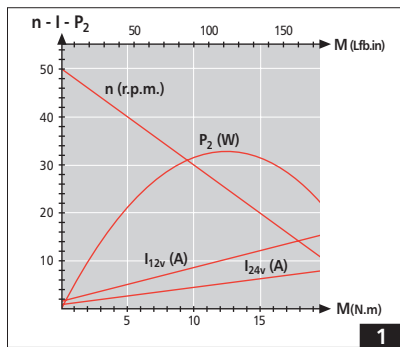

162

168

169

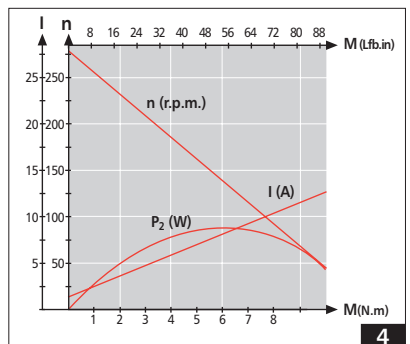
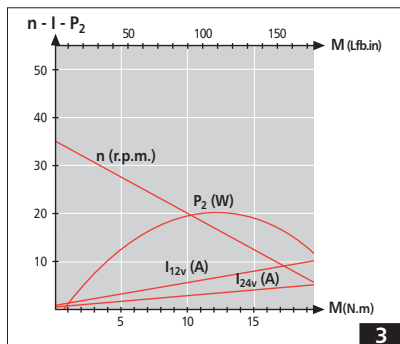
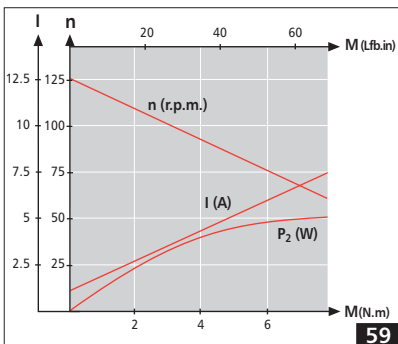

260

269