

Sonic Fast Recovery Diode

High Performance Fast Recovery Diode
 Low Loss and Soft Recovery
 Single Diode

$V_{RRM} = 1800\text{ V}$
 $I_{FAV} = 60\text{ A}$
 $t_{rr} = 230\text{ ns}$

Part number

DH60-18A

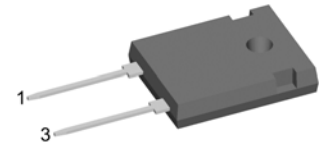
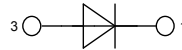

Backside: cathode

Features / Advantages:

- Planar passivated chips
- Very low leakage current
- Very short recovery time
- Improved thermal behaviour
- Very low I_{rm} -values
- Very soft recovery behaviour
- Avalanche voltage rated for reliable operation
- Soft reverse recovery for low EMI/RFI
- Low I_{rm} reduces:
 - Power dissipation within the diode
 - Turn-on loss in the commutating switch

Applications:

- Antiparallel diode for high frequency switching devices
- Antisaturation diode
- Snubber diode
- Free wheeling diode
- Rectifiers in switch mode power supplies (SMPS)
- Uninterruptible power supplies (UPS)

Package:

- Housing: TO-247
- Industry standard outline
- Epoxy meets UL 94V-0
- RoHS compliant

Ratings

Symbol	Definition	Conditions	Ratings			Unit
			min.	typ.	max.	
V_{RRM}	max. repetitive reverse voltage				1800	V
I_R	reverse current	$V_R = 1800\text{ V}$			200	μA
		$V_R = 1800\text{ V}$			2	mA
V_F	forward voltage	$I_F = 60\text{ A}$			2.04	V
		$I_F = 120\text{ A}$			2.57	V
		$I_F = 60\text{ A}$			2.03	V
		$I_F = 120\text{ A}$			2.73	V
I_{FAV}	average forward current	rectangular $d = 0.5$			60	A
V_{F0}	threshold voltage	} for power loss calculation only			1.28	V
r_F	slope resistance				12	m Ω
R_{thJC}	thermal resistance junction to case				0.30	K/W
T_{VJ}	virtual junction temperature		-55		150	$^{\circ}\text{C}$
P_{tot}	total power dissipation				415	W
I_{FSM}	max. forward surge current	$t = 10\text{ ms}$ (50 Hz), sine			700	A
I_{RM}	max. reverse recovery current				60	A
		$I_F = 60\text{ A}; V_R = 1200\text{ V}$			70	A
t_{rr}	reverse recovery time	$-di_F/dt = 800\text{ A}/\mu\text{s}$			230	ns
					350	ns
C_J	junction capacitance	$V_R = 1200\text{ V}; f = 1\text{ MHz}$			32	pF

Symbol	Definition	Conditions	Ratings			Unit
			min.	typ.	max.	
I_{RMS}	RMS current	per terminal			70	A
R_{thCH}	thermal resistance case to heatsink			0.25		K/W
T_{stg}	storage temperature		-55		150	°C
Weight				6		g
M_D	mounting torque		0.8		1.2	Nm
F_C	mounting force with clip		20		120	N

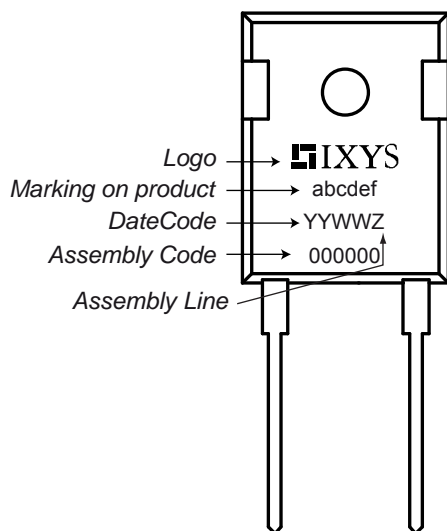
Product Marking

Ordering	Ordering Number	Marking on Product	Delivery Mode	Quantity	Code No.
Standard	DH60-18A	DH60-18A	Tube	30	496553

Similar Part	Package	Voltage Class
DH60-14A	TO-247AD (2)	1400
DH60-16A	TO-247AD (2)	1600

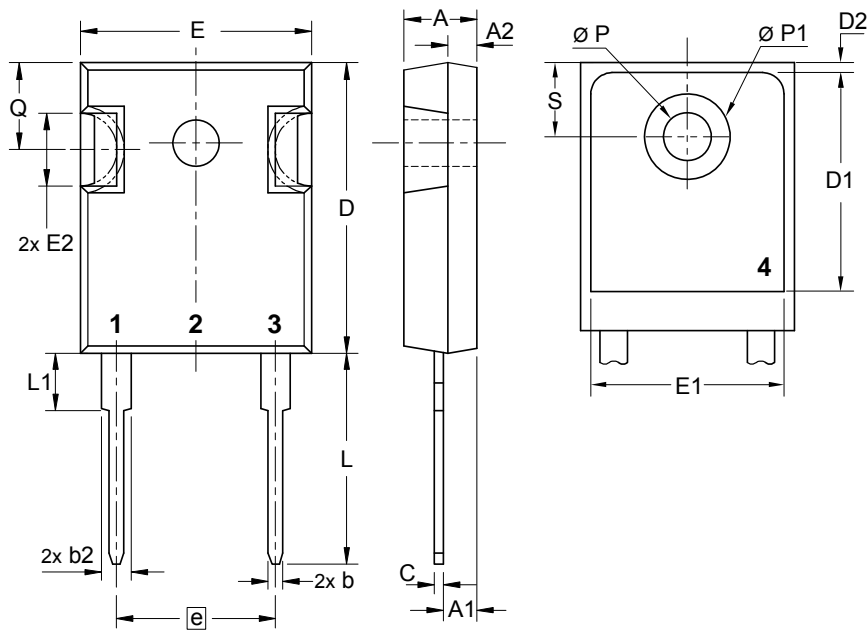
Outlines TO-247

Sym.	Inches		Millimeter	
	min.	max.	min.	max.
A	0.185	0.209	4.70	5.30
A1	0.087	0.102	2.21	2.59
A2	0.059	0.098	1.50	2.49
D	0.819	0.845	20.79	21.45
E	0.610	0.640	15.48	16.24
E2	0.170	0.216	4.31	5.48
e	0.430	BSC	10.92	BSC
L	0.780	0.800	19.80	20.30
L1	-	0.177	-	4.49
Ø P	0.140	0.144	3.55	3.65
Q	0.212	0.244	5.38	6.19
S	0.242	BSC	6.14	BSC
b	0.039	0.055	0.99	1.40
b2	0.065	0.094	1.65	2.39
b4	0.102	0.135	2.59	3.43
c	0.015	0.035	0.38	0.89
D1	0.515	-	13.07	-
D2	0.020	0.053	0.51	1.35
E1	0.530	-	13.45	-
Ø P1	-	0.29	-	7.39

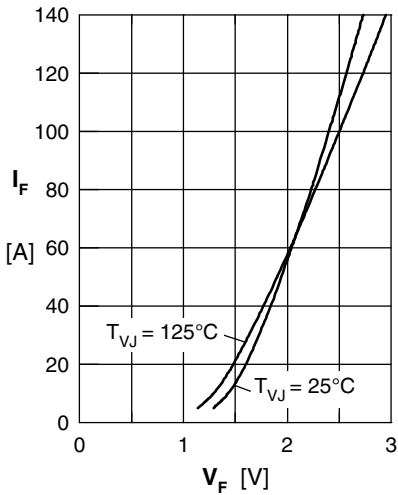

Fig. 1 Typ. ward current I_F versus V_F

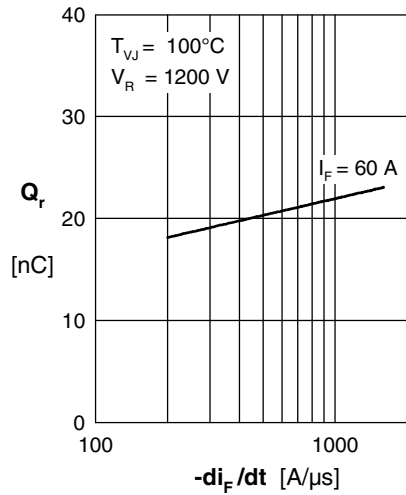

Fig. 2 Typ. reverse recovery charge Q_r versus $-di_F/dt$

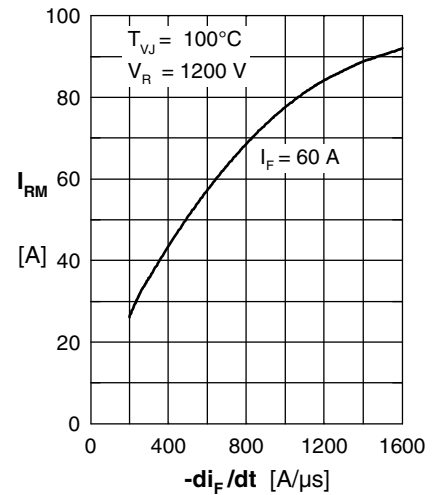

Fig. 3 Typ. peak reverse current I_{RM} versus $-di_F/dt$

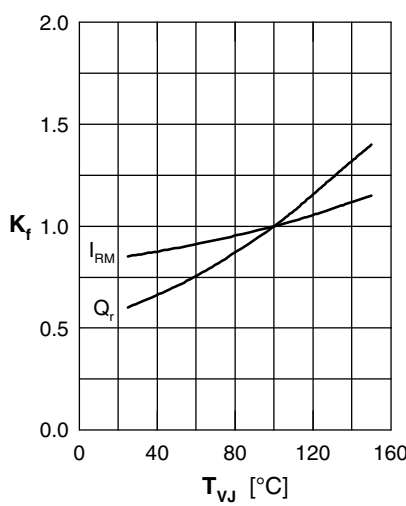

Fig. 4 Dynamic parameters Q_r , I_{RM} versus T_{VJ}

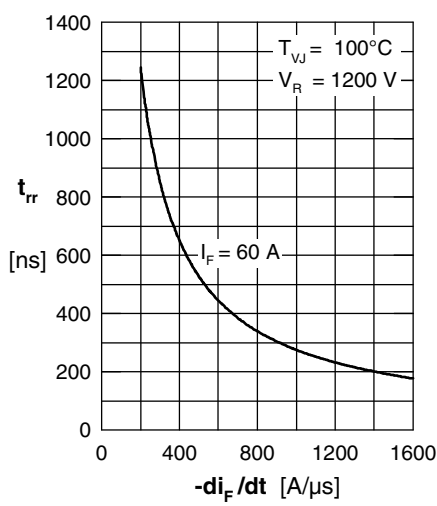

Fig. 5 Typ. recovery time t_{rr} versus $-di_F/dt$

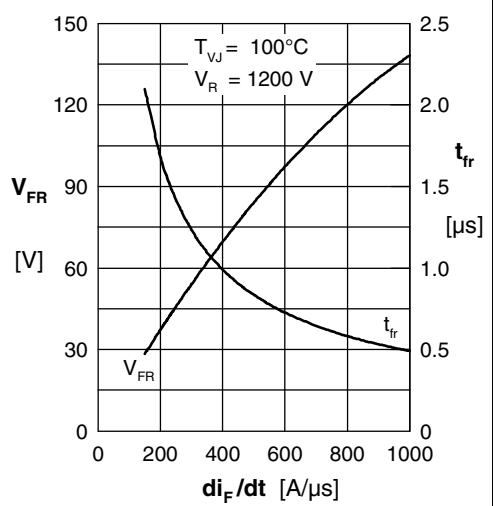

Fig. 6 Typ. peak forward voltage V_{FR} & typ. forward recovery time t_{fr} versus di_F/dt

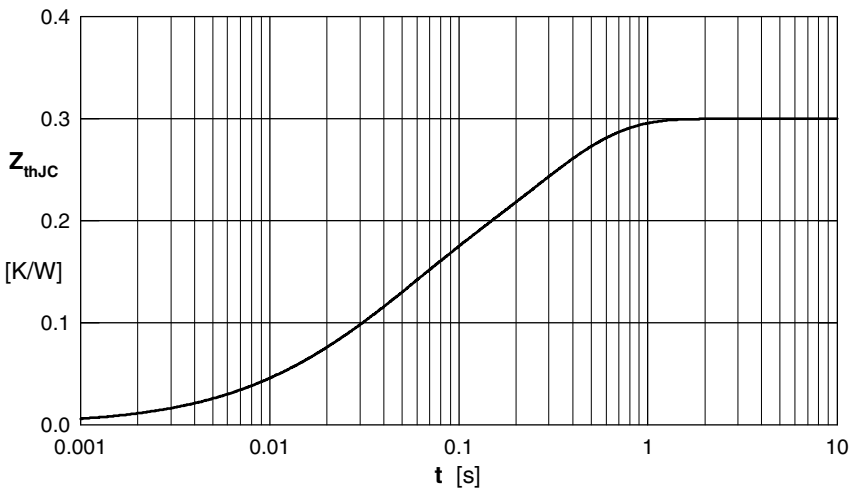

Fig. 7 Transient thermal resistance junction to case

i	R_i	θ_{jc}
1	0.021	0.0093
2	0.11	0.038
3	0.169	0.274