

profile LED CORNER

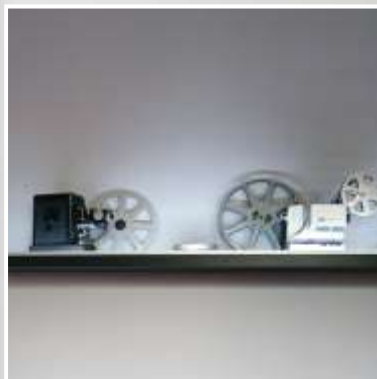

Corner LED Profile

profile LED CORNER BC/UX

UE Patent No. 001321780-0005

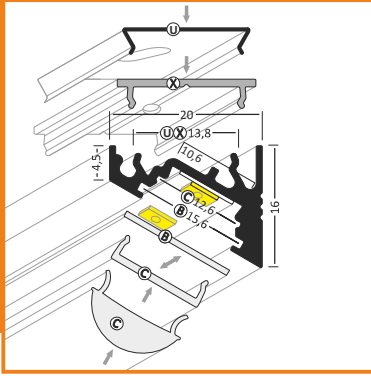

| | | |
|--|--|---|
| anodized 1000mm 83040020 2000mm 83050020 | black anodized 1000mm 83040021 2000mm 83050021 | white painted 1000mm 83040001 2000mm 83050001 |
|--|--|---|

corner profile 30 or 60 degree;
can be used as a lighting inside cabinets,
wardrobes and cupboards;
can be mounted directly or by
mounting plate

standard lengths: 1000, 2000mm;
max. length 4000mm;
length above 2000mm - own collection

LIGHTING ANGLES

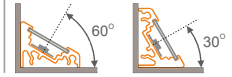

COVERS



cover slide B ▶ white ▶ frosted ▶ transparent

| | | |
|---------------------------|---------------------------|---------------------------|
| 1000mm 76240038 | 1000mm 76240039 | 1000mm 76240016 |
| 2000mm 76250038 | 2000mm 76250039 | 2000mm 76250016 |

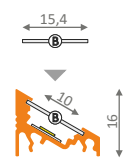
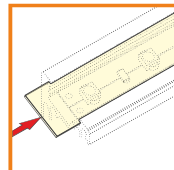

cover click C ▶ white ▶ transparent

| | |
|---------------------------|---------------------------|
| 1000mm 76320038 | 1000mm 76320000 |
| 2000mm 76330038 | 2000mm 76330000 |

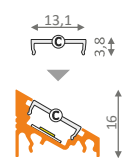
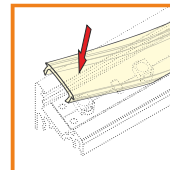

cover lens C ▶ transparent

| |
|---------------------------|
| 1000mm 76290000 |
| 2000mm 76300000 |

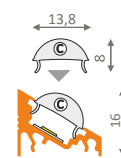
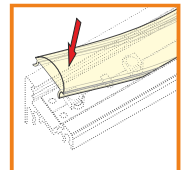

ENDING

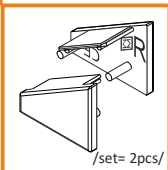

ending CORNER
▶ **83160022**
▶ **83160001**
▶ **83160002**
▶ **83160040**

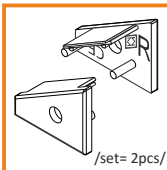

ending CORNER with hole
▶ **83140022**
▶ **83140001**
▶ **83140002**
▶ **83140040**

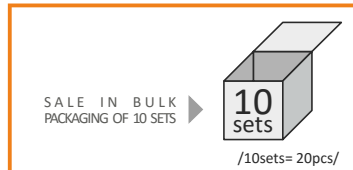

SALE IN BULK
PACKAGING OF 10 SETS
10 sets
/10sets= 20pcs/

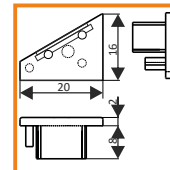

ENDING THICKNESS INCREASES
THE LENGTH OF THE PROFILE

| | | | |
|-----------------------------|--|--|--|
| grey ▶ 83160022 | ending CORNER with hole ▶ 83140022 | ending CORNER ▶ 83150022 (min.10x) | ending CORNER with hole ▶ 83130022 (min.10x) |
| white ▶ 83160001 | ▶ 83140001 | ▶ 83150001 (min.10x) | ▶ 83130001 (min.10x) |
| black ▶ 83160002 | ▶ 83140002 | ▶ 83150002 (min.10x) | ▶ 83130002 (min.10x) |
| silver ▶ 83160040 | ▶ 83140040 | ▶ 83150040 (min.10x) | ▶ 83130040 (min.10x) |

MOUNTING

OPTIONAL MOUNTING:



mounting plate X
76260000

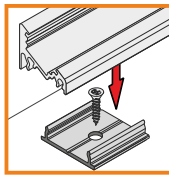
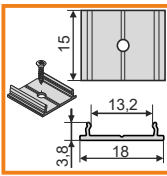

mounting plate U flexible
76380000

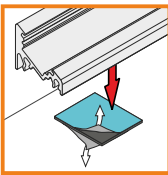
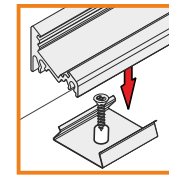
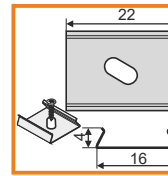

two-sided adhesive tape
76340000

OPTIONAL CONNECTOR:



connector X
76350000

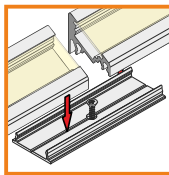
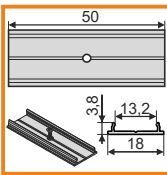

| | | | |
|--------------------|-----------------------------|-----------------------------------|----------------------------------|
| connector L CORNER | anodized 83110020 | black anodized 83110021 | white painted 83110001 |
|--------------------|-----------------------------|-----------------------------------|----------------------------------|

