

## DETAILS

<b>Product Number</b>	C14164_STRADA-2X2-ME-WIDE1
<b>Family</b>	Strada-Module
<b>Type</b>	Lens array
<b>Color</b>	clear
<b>Diameter</b>	50x50 mm
<b>Height</b>	8.3 mm
<b>Style</b>	square
<b>Optic Material</b>	PMMA
<b>Holder Material</b>	
<b>Fastening</b>	screw, pin, glue
<b>Status</b>	ready
<b>ROHS Compliant</b>	Yes
<b>Date Updated</b>	22/01/2015



## OPTICAL PROPERTIES

LED	Viewing Angle	Light Beam	Efficiency	cd/lm	Connector
Oslon Square PC	Asymmetric deg	Streetligh...	84 %	0.900	: Protective Plate, Glass
XT-E	sim: Asymmetric	Streetligh...	sim: 84 %	sim: 0.000	: Protective Plate, Glass
TL1L4	Asymmetric deg	Streetligh...	83 %	0.880	: Protective Plate, Glass
LUXEON T	sim: Asym	Streetligh...	sim: 84 %	sim: 0.000	: Protective Plate, Glass
XP-G2	Asym deg	Streetligh...	83 %	0.860	: Protective Plate, Glass
LUXEON TX	Asymmetric deg	Streetligh...	84 %	0.880	: Protective Plate, Glass
XP-L	Asymmetric deg	Streetligh...	83 %	0.660	: Protective Plate, Glass

D

C

B

A

4

4

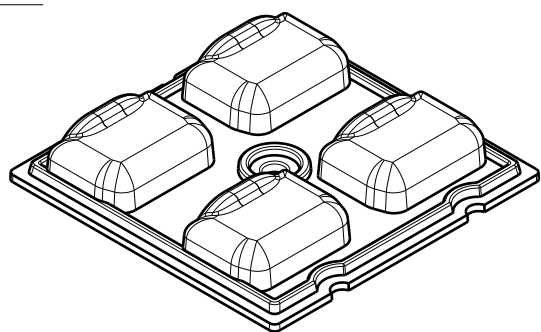
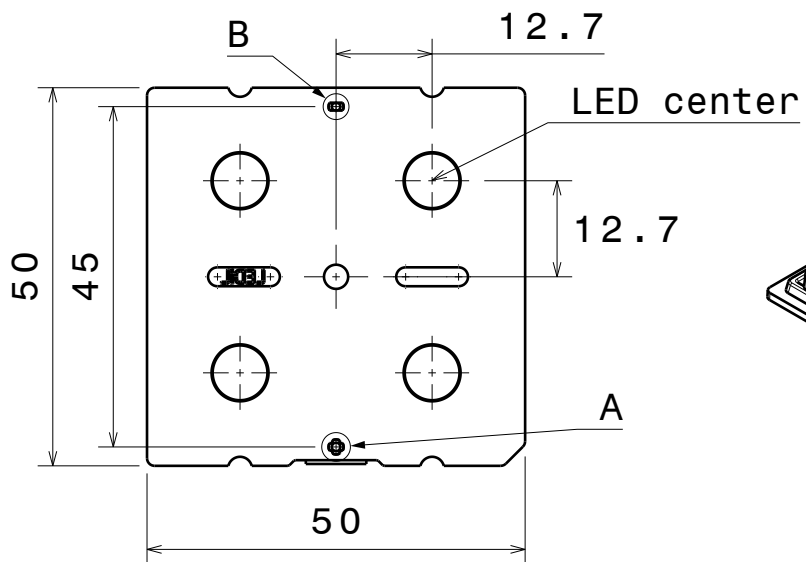

Isometric view

Bottom view

3

3

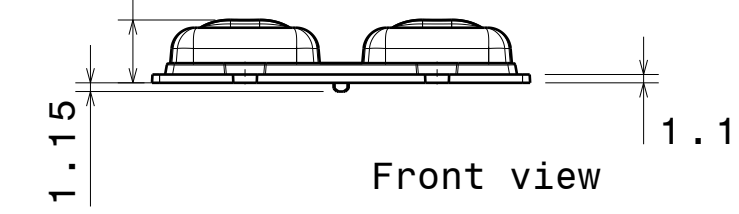

Front view

2

2

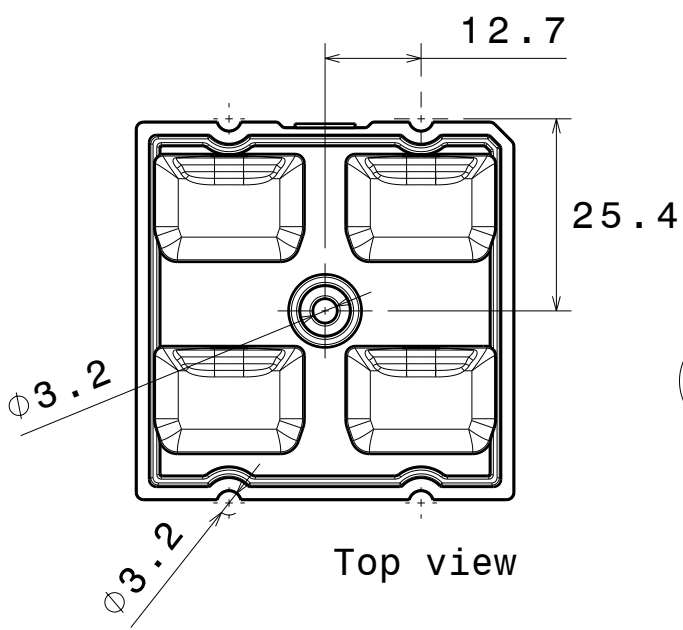

Top view

Detail B

Detail A

Tolerances if not otherwise shown  
 According to DIN ISO 2768-1  
 Linear measures:  
 Up to 30mm class M, otherwise class C.  
 According to DIN ISO 2768-2  
 Form and position: class L

<b>LEDiL</b>	Ledil Oy		
	Salorankatu 10 FIN 24240 SALO Finland		

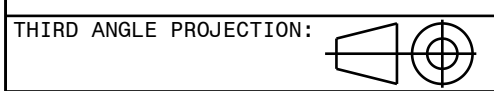

**DRAWING TITLE**  
**STRADA-2X2-ME-WIDE1**

This drawing is the property of LEDiL Oy. It may not be reproduced, copied or communicated without a written agreement with LEDiL Oy.

<b>SIZE</b>	<b>PART NUMBER</b>
<b>A4</b>	<b>C14164</b>

<b>SCALE</b>	<b>1:1</b>	<b>WEIGHT</b>	-	<b>SHEET</b>	<b>1/1</b>
--------------	------------	---------------	---	--------------	------------

D

A

1

1

Luminaire: LEDiL Oy C14164\_STRADA-2X2-ME-WIDE1\_(SQ-PC)\_glass  
Lamps: 1 x OSRAM\_OSLON\_SQUARE\_PC\_2x2\_(GWCSSRM1.PC)  
\_387.654lm@250mA\_P=2.97181W\_CCT=5201K\_I=249.9mA

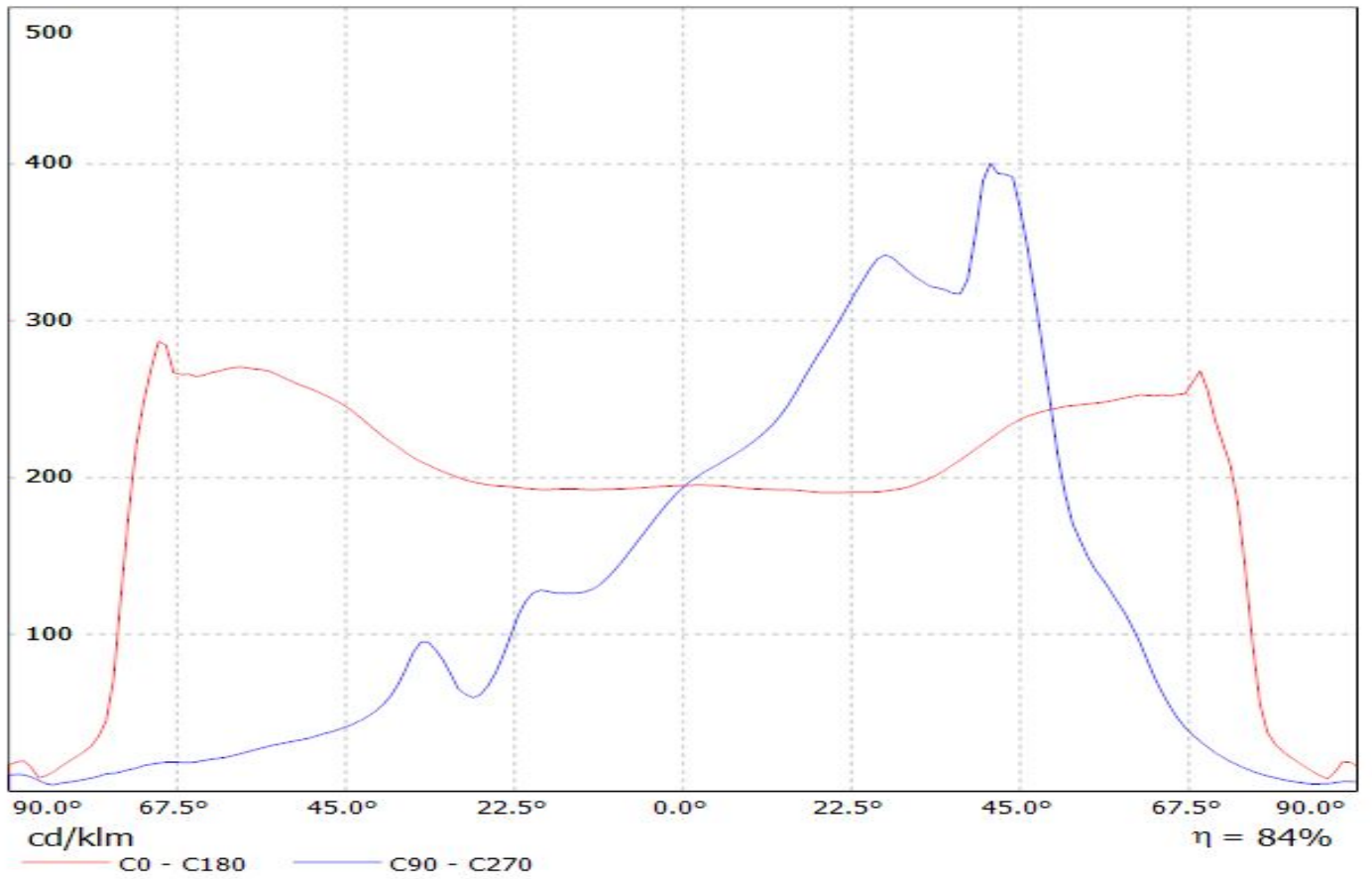

**Ledil C14164\_STRADA-2X2-ME-WIDE1\_(TL1L4)\_glass / LDC (Linear)**

Luminaire: Ledil C14164\_STRADA-2X2-ME-WIDE1\_(TL1L4)\_glass

Lamps: 1 x Toshiba\_TL1L4\_2x2\_(TL1L4-DW0)\_444.089lm@250mA\_CCT=6500K\_P=2.9W\_I=0.25A

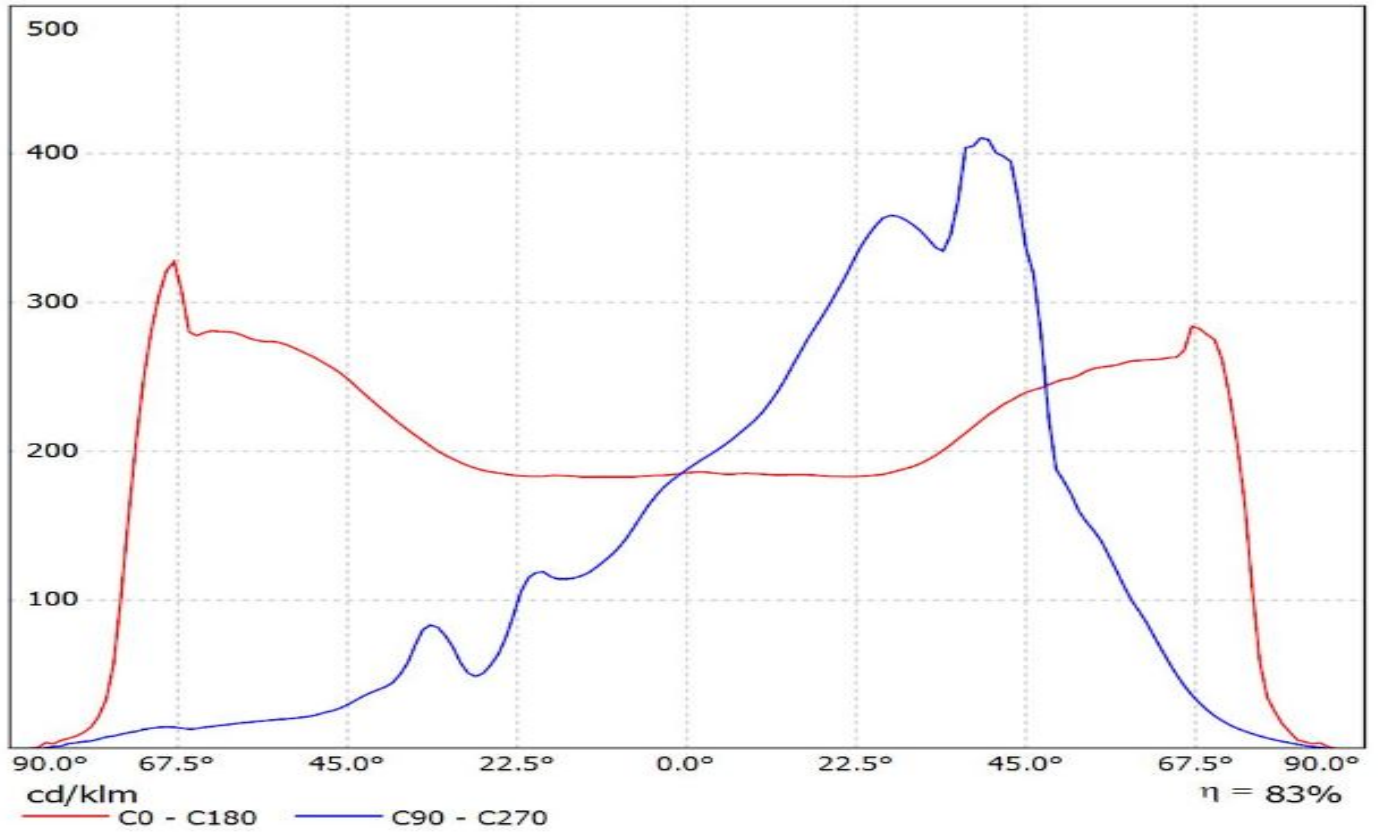

Luminaire: LEDiL Oy C14164\_STRADA-2X2-ME-WIDE1\_(XP-G2) with 4mm glass cover  
Lamps: 1 x CREE\_XP-G2\_2x2\_(XPGBWT-L1-000-00G51)\_407.74lm@250mA\_CCT=7181K\_P=2.95432W\_I=249.9mA

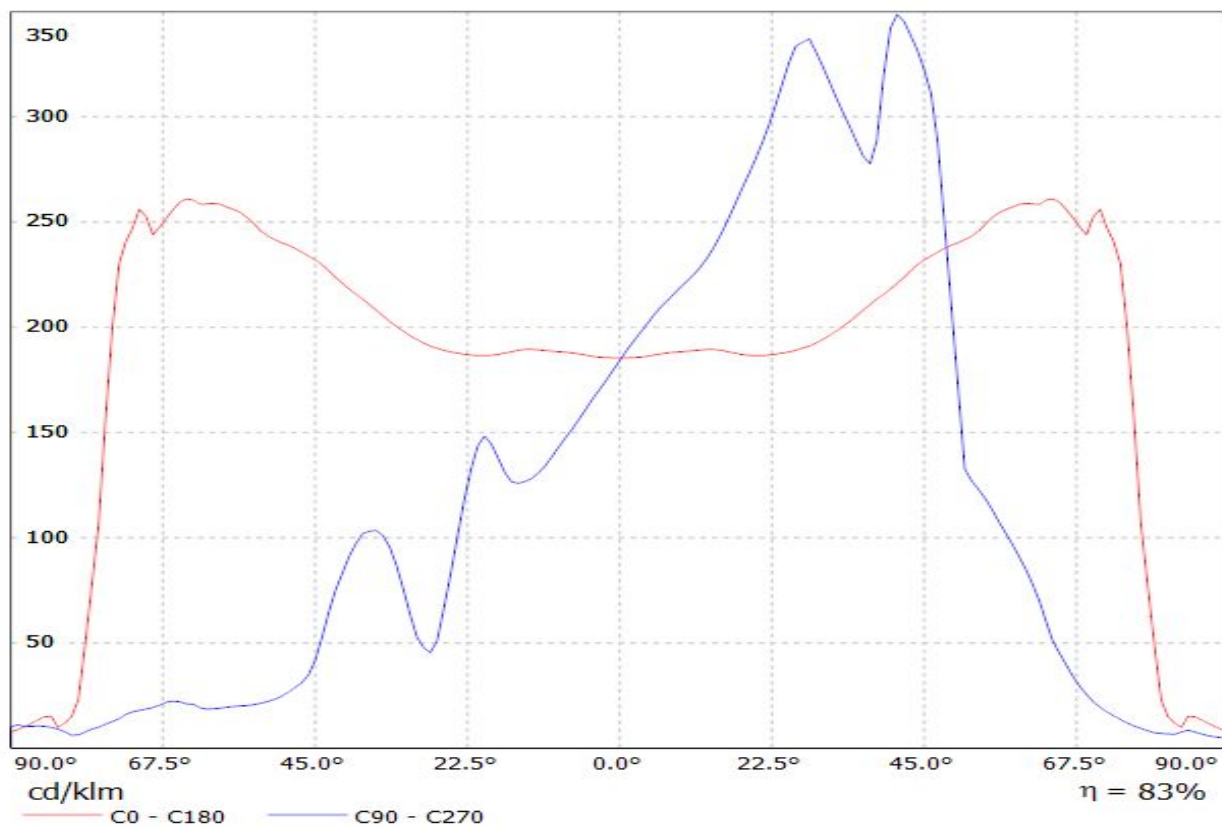

Luminaire: LEDiL Oy C14164\_STRADA-2X2-ME-WIDE1 (Luxeon\_TX)\_glass  
Lamps: 1 x Luxeon\_TX\_2x2\_320.18lm@250mA\_P=2.79576W\_I=249.8mA

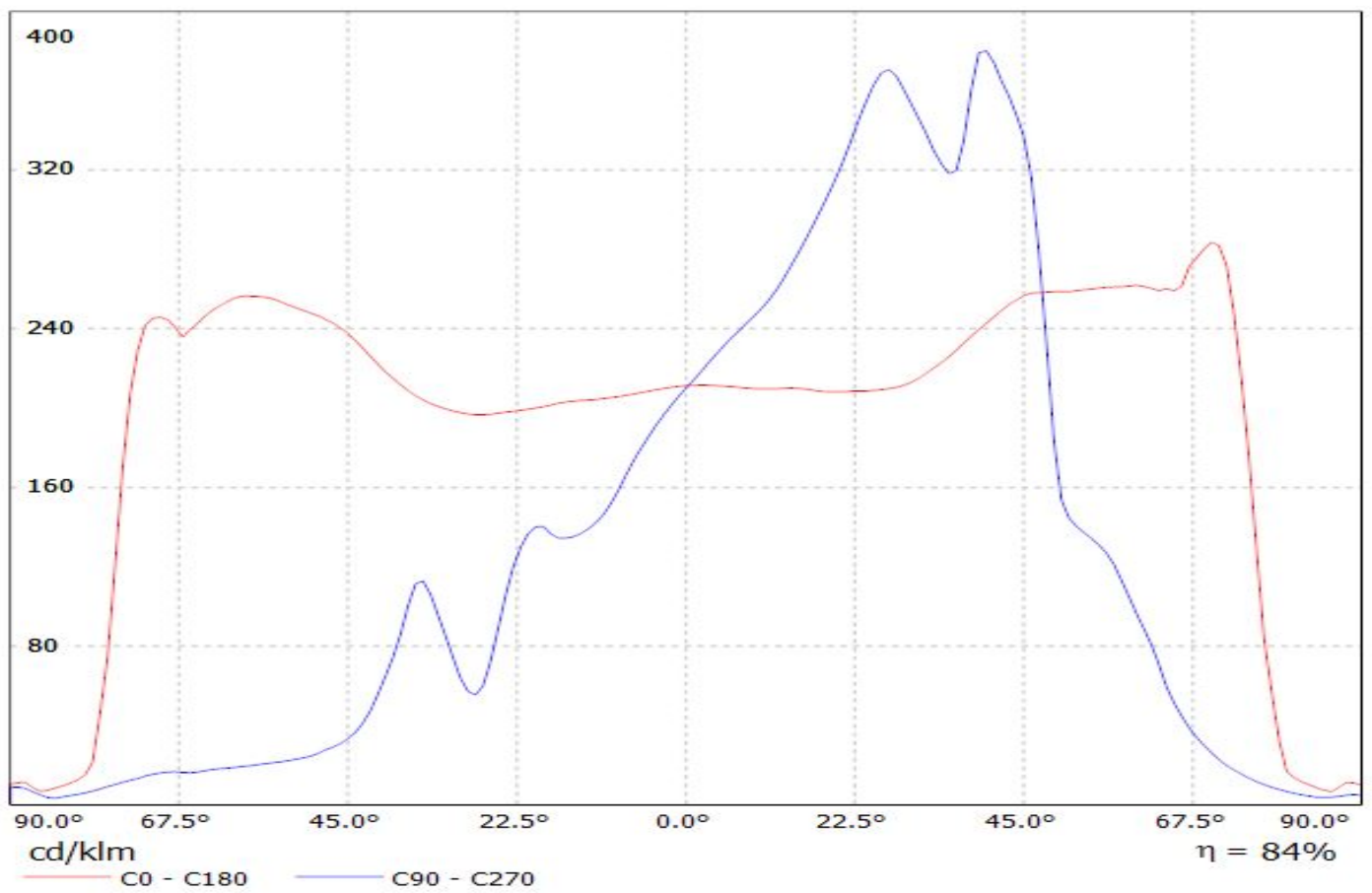

# Ledil C14164\_STRADA-2X2-ME-WIDE1\_(XP-L)\_glass / LDC (Linear)

Luminaire: Ledil C14164\_STRADA-2X2-ME-WIDE1\_(XP-L)\_glass  
Lamps: 1 x CREE\_XP-L\_2x2\_(XPLAWT-0-1B0-V40-00-0001)  
\_512.395lm@250mA\_CCT=7600K\_P=2.8W\_I=0.25A

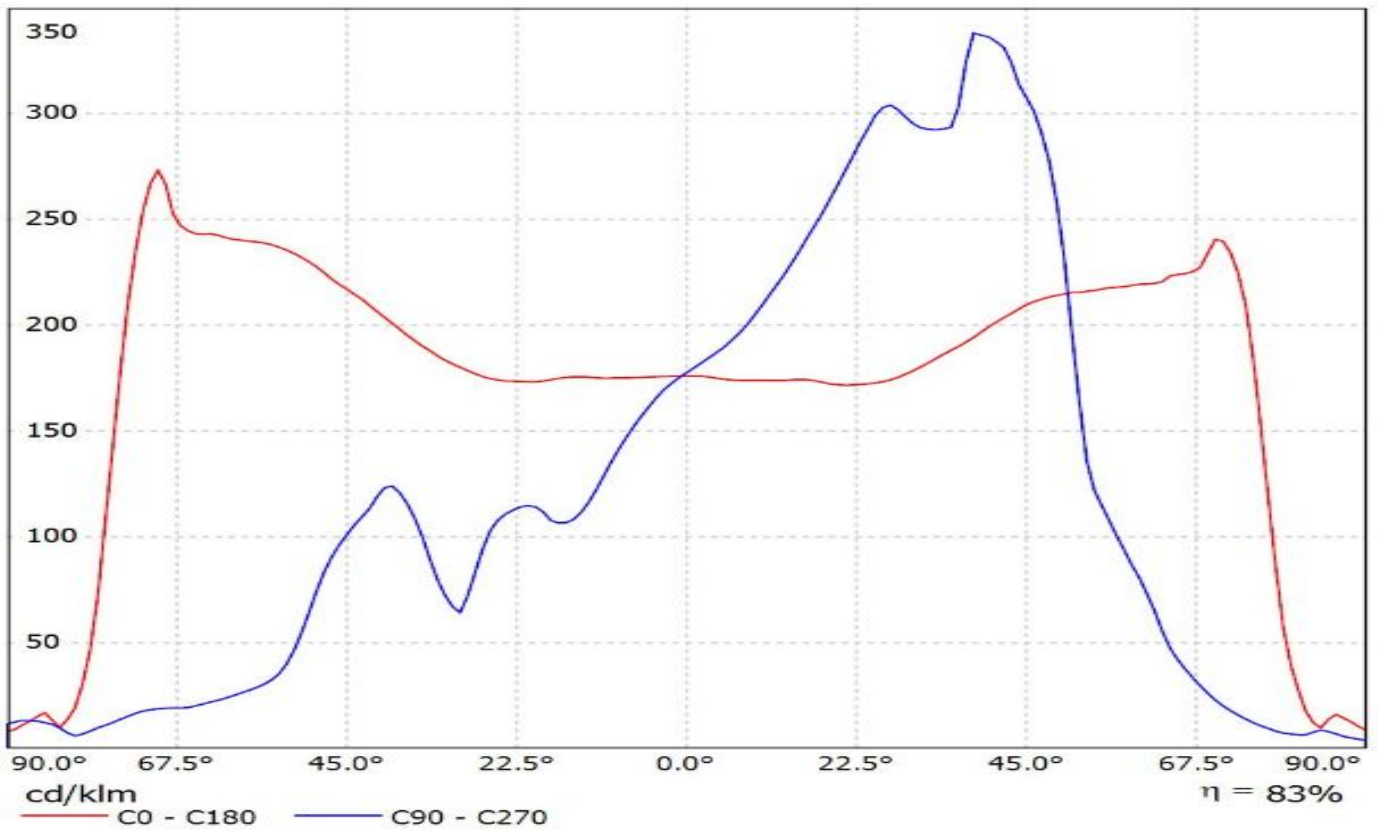

Luminaire: LEDiL Oy C14164\_STRADA-2X2-ME-WIDE1\_(SQ-PC)\_glass  
Lamps: 1 x OSRAM\_OSLON\_SQUARE\_PC\_2x2\_(GWCSSRM1.PC)  
\_387.654lm@250mA\_P=2.97181W\_CCT=5201K\_I=249.9mA

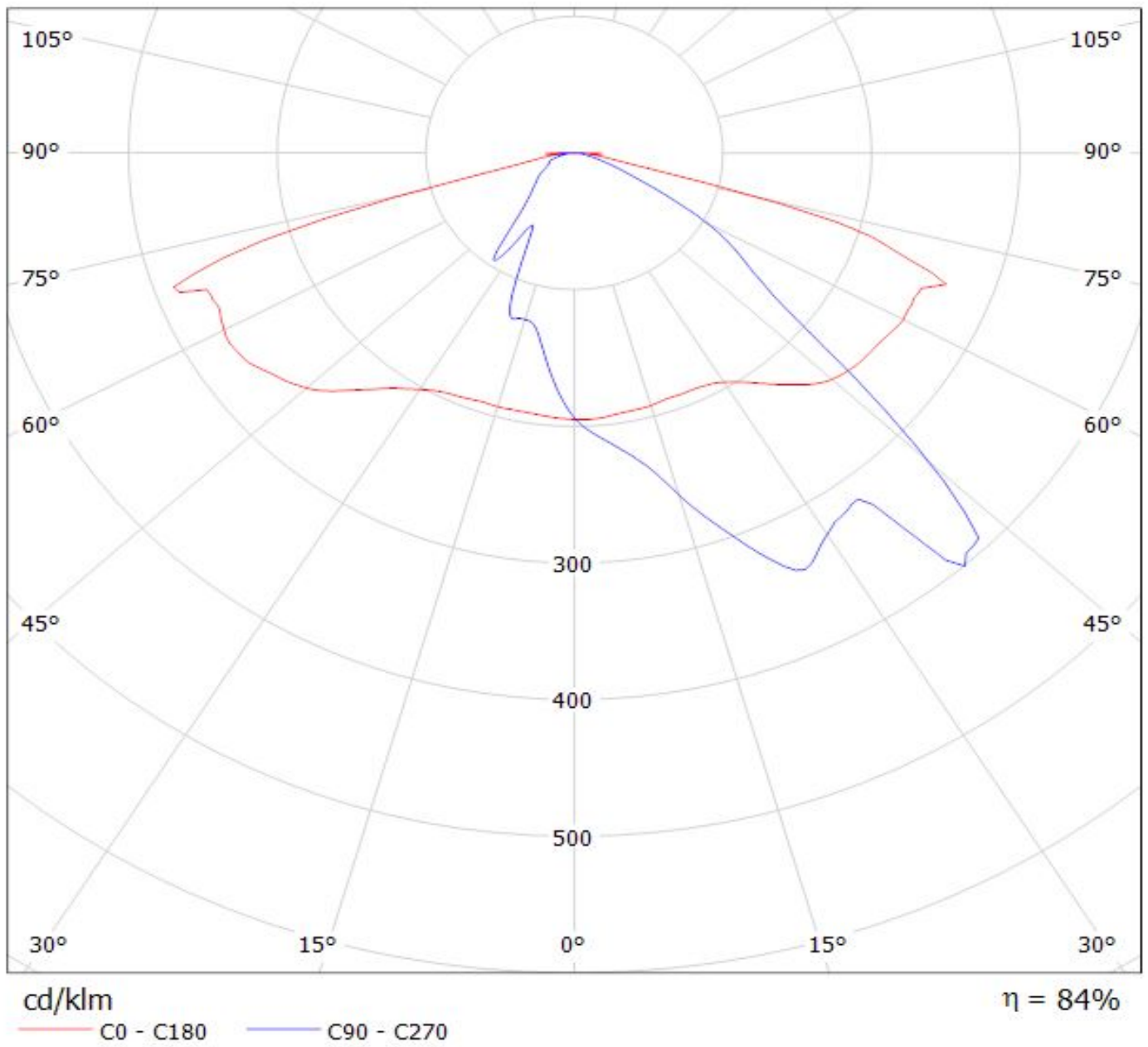



# Ledil C14164\_STRADA-2X2-ME-WIDE1\_(TL1L4)\_glass / LDC (Polar)

Luminaire: Ledil C14164\_STRADA-2X2-ME-WIDE1\_(TL1L4)\_glass

Lamps: 1 x Toshiba\_TL1L4\_2x2\_(TL1L4-DW0)\_444.089lm@250mA\_CCT=6500K\_P=2.9W\_I=0.25A

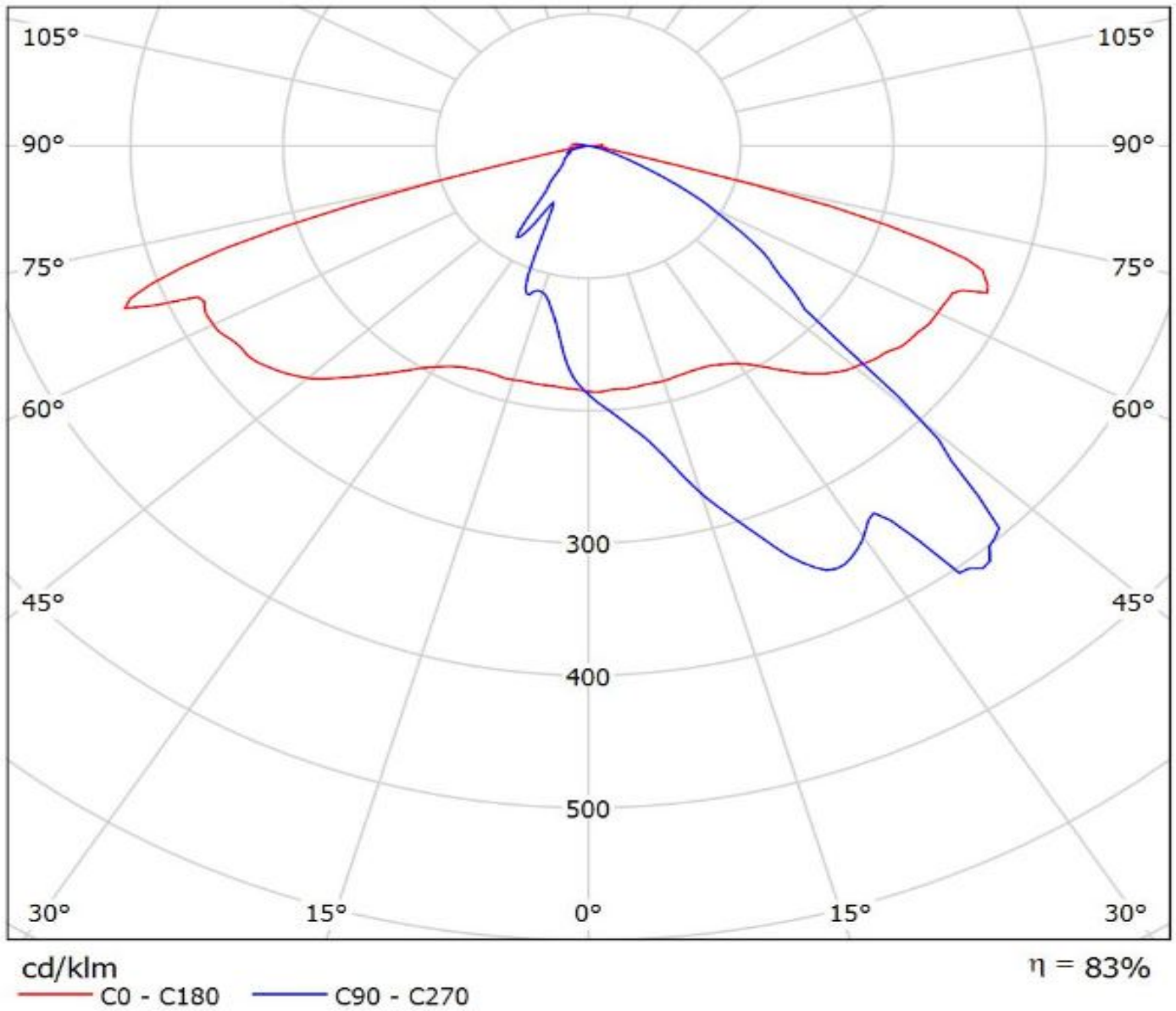

Luminaire: LEDiL Oy C14164\_STRADA-2X2-ME-WIDE1\_(XP-G2) with 4mm glass cover

Lamps: 1 x CREE\_XP-G2\_2x2\_(XPGBWT-L1-000-00G51)\_407.74lm@250mA\_CCT=7181K\_P=2.95432W\_I=249.9mA

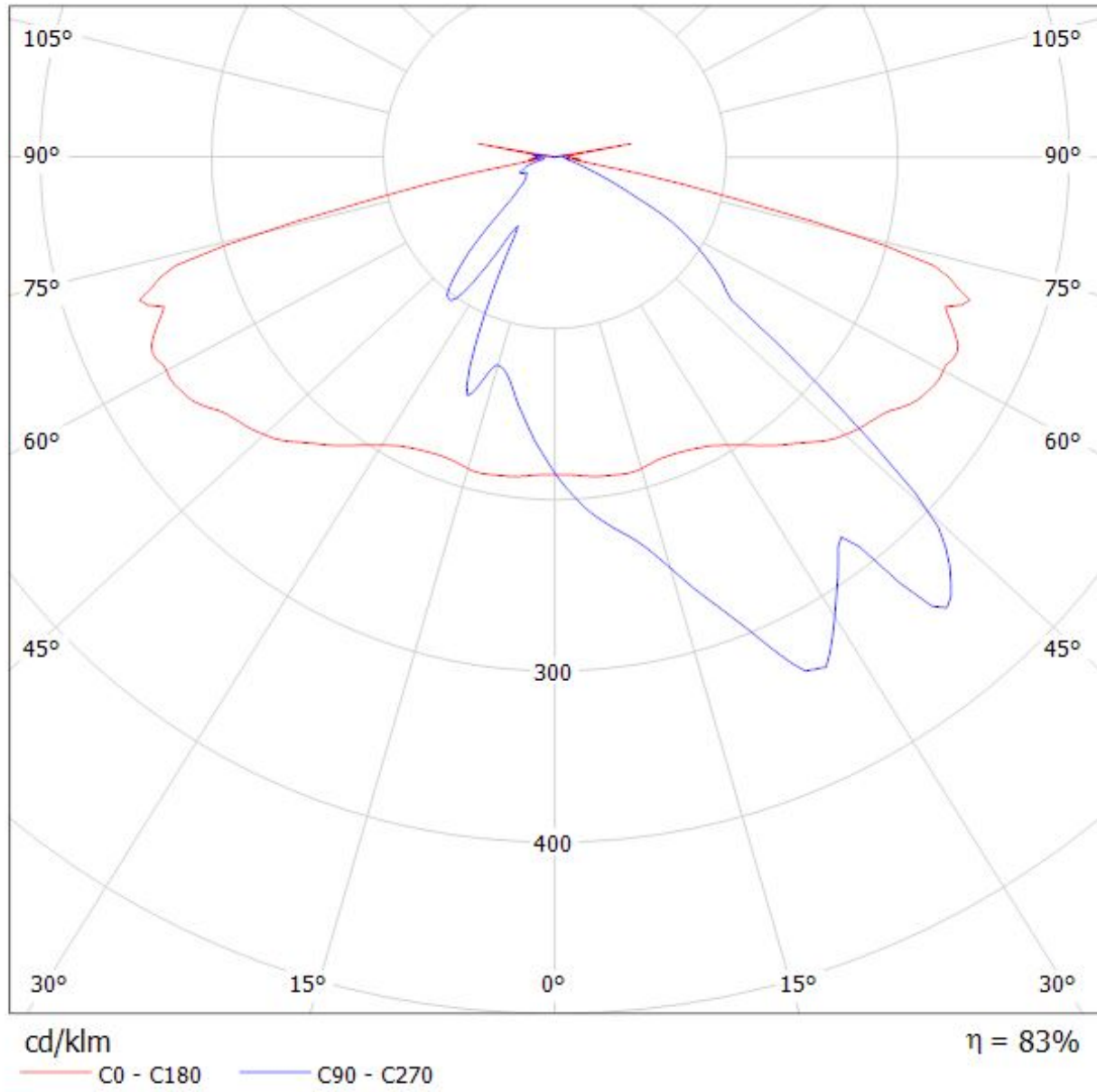

Luminaire: LEDiL Oy C14164\_STRADA-2X2-ME-WIDE1\_(Luxeon\_TX)\_glass  
Lamps: 1 x Luxeon\_TX\_2x2\_320.18lm@250mA\_P=2.79576W\_I=249.8mA

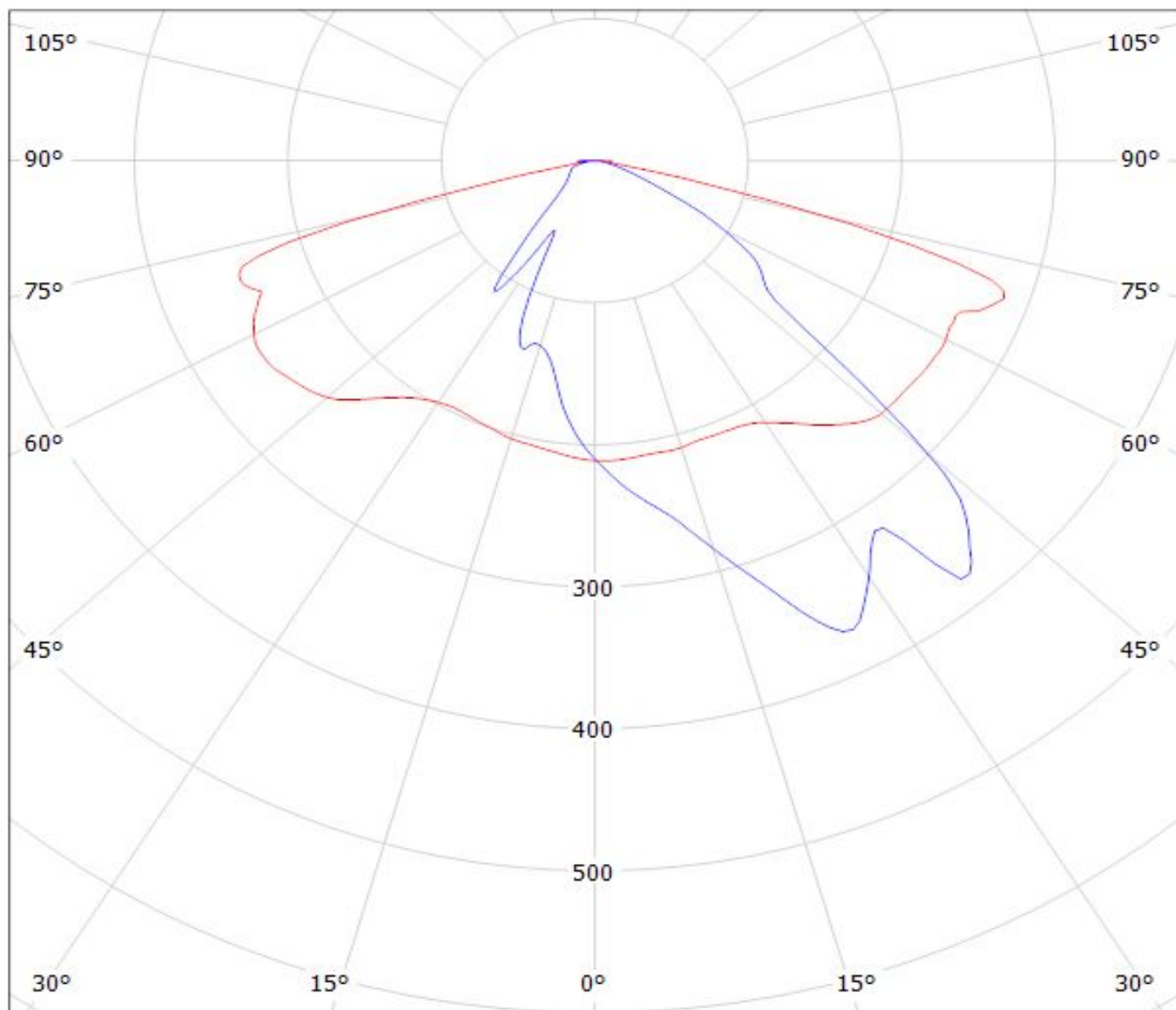

cd/klm

— C0 - C180    — C90 - C270

$\eta = 84\%$

# Ledil C14164\_STRADA-2X2-ME-WIDE1\_(XP-L)\_glass / LDC (Polar)

Luminaire: Ledil C14164\_STRADA-2X2-ME-WIDE1\_(XP-L)\_glass

Lamps: 1 x CREE\_XP-L\_2x2\_(XPLAWT-0-1B0-V40-00-0001)

\_512.395lm@250mA\_CCT=7600K\_P=2.8W\_I=0.25A

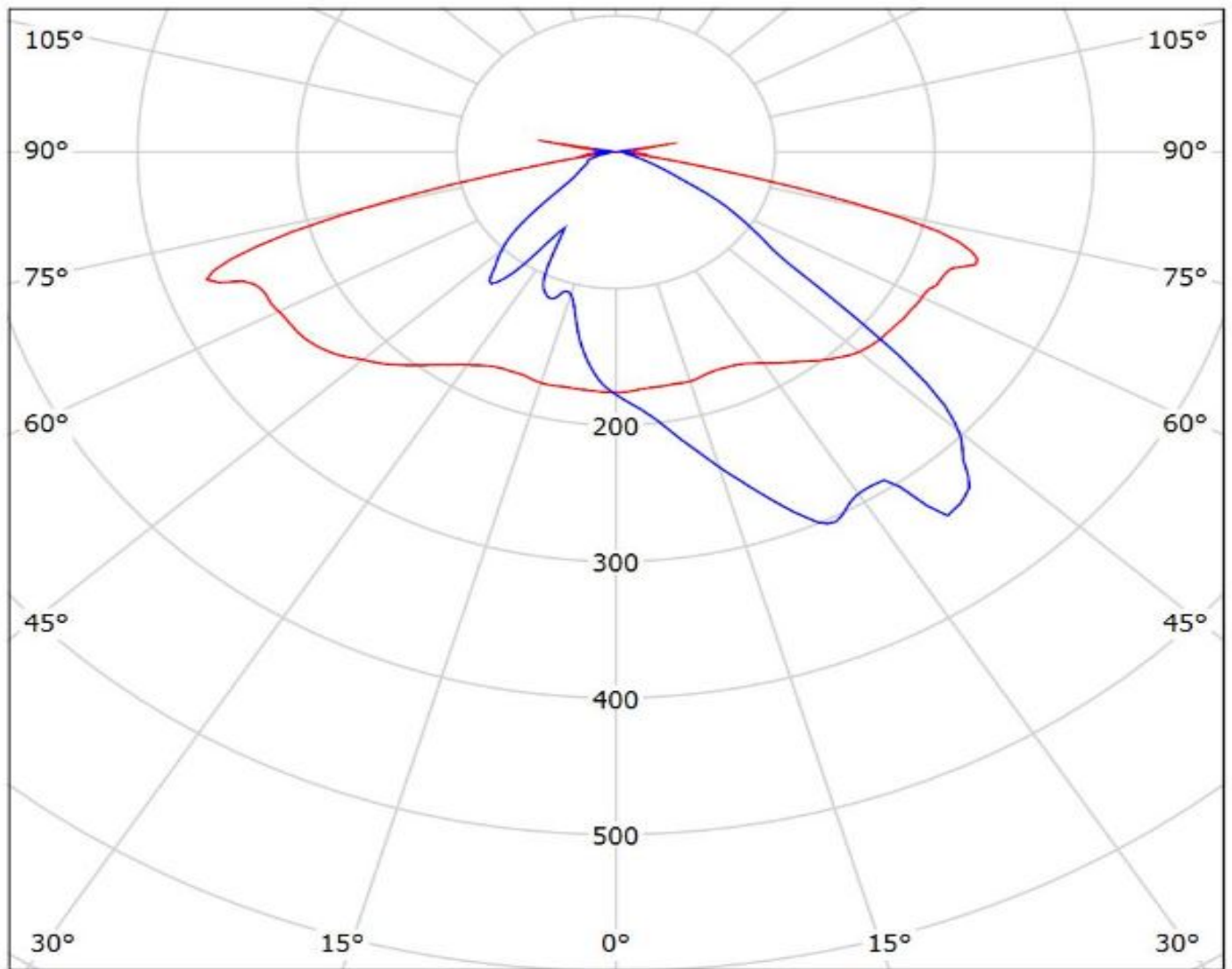

cd/klm

— C0 - C180 — C90 - C270

$\eta = 83\%$

**NOTE: The typical divergence will be changed by different color, chip size and chip position tolerance. The typical total divergence is the full angle measured where the luminous intensity is half of the peak value.**