



## BX Series

### Explosion-Proof Limit Switch

#### DESCRIPTION

The BX is ideal for outdoor use or in adverse environments where a combination of explosion proof plus sealing requirements are needed. To comply with explosion-proof requirements the BX has flame paths within the housing, which cool exploding gases below the ignition temperature before they reach explosive gases surrounding the housing. Flame paths on the BX are (1) an extended plunger between the switch cavity and head and (2) the cover-housing threads on the front of the switch.

These products are weather sealed for outdoor use and designed for explosive gas/dust environments. They may be interchanged with HDLS products by using an adapter plate. All heads are field adjustable at 90° increments. Side rotary BX products can be adjusted for clockwise and counter-clockwise actuation.

Honeywell explosion-proof switches are designed specifically for use in hazardous location applications. The BX enclosure is sealed for protection against corrosion, water, dust and oil as defined in IEC60529. The temperature rating for these products depends upon the seal material used. Products using a fluorosilicone seal have a rating of -40 °C [-40 °F] to

70 °C [158 °F]. Products using a fluorocarbon seal have a rating of -12 °C [10 °F] to 70 °C [158 °F]. These enclosures meet Ex d IIC T6, Ta -40 °C to 70 °C and Ta -12 °C to 70 °C, respectively. As well as Ex d tD A21 IP67 T85 °C. SIR A 00ATEX1037X and IECEx SIR 07.0102X.

Compliance with the Essential Health and Safety Requirements has been assured by compliance with EN 60079-0:2006, EN 60079-1:2007, EN 61241-0:2004, EN 61241-0:2006, IEC 60079-0:2004 4<sup>th</sup> Ed., IEC 60079-0:2007 6<sup>th</sup> Ed., IEC 61241-0:2004 1<sup>st</sup> Ed., and IEC 61241-1:2004 1<sup>st</sup> Ed. The maximum construction gap (ic) is less than that required by Table 2 of EN/IEC60079-1:2007, clause 5.2.2 as detailed below.

| Flame path         | Max. gap | Comment                  |
|--------------------|----------|--------------------------|
| Push rod & bearing | 0,076 mm | Cylindrical spigot joint |

BX with conduit types 1/2-14NPT, 3/4-14NPT also meet the North American Hazardous Locations Designation: NEMA 7 - Class I, Groups B, C and D; NEMA 9 - Class II, Groups E, F and G and comply with UL Standard: UL 894, CSA Standard: C22.2 No. 25-1966, C22.2 No. 30-M1986.

#### FEATURES



- UL, CSA, ATEX, IEC Ex
- IP67; NEMA 1, 3, 4, 6, 13 (Div. 1, Class I, Groups B, C, & D
  - Div 1, Class II, Groups E, F, & G • II 2 G; Ex d IIC T6 • II 2 D; Ex d tD A21 T85°C)
- Diverse conduit selection for wide range of applications
- Compatible with LSX ; Tracking interchangeability with MICRO SWITCH™ ML-E1 and HDLS
- Variety of heads and non-sparking actuators
- 10 A continuous carry electrical rating
- Choice of silver or gold contacts
- Internal grounding screw
- Fluorocarbon and low-temperature sealing

#### POTENTIAL APPLICATIONS

- Control valves and actuators
- Offshore drilling
- Grain elevators
- Petrochemical plants
- Chemical plants
- Waste treatment
- Paint booths
- Mining conveyors
- Pulp and paper coating
- Hazardous waste handling



# BX Series

## SELECTION GUIDE

|                                |   |     |  |
|--------------------------------|--|---|---|
| Features                       | BX4A3K   | BX4A3K-1A   | BX4C3K  |
| Actuator                       | Lever not included - reference lever required accessory  | 1.5 in fixed length lever with front mounted nylon roller (.75 in dia. x .25 in wide) | N/A   |
| Termination Type               | 20 mm conduit  | 20 mm conduit   | 20 mm conduit   |
| Circuitry                      | 1NC 1NO single-pole double-throw, snap-action, double-break  | 1NC 1NO single-pole double-throw, snap-action, double-break                           | 1NC 1NO single-pole double-throw, snap-action, double-break                         |
| Approvals                      | UL, CSA, ATEX, IEC Ex  | UL, CSA, ATEX, IEC Ex   | UL, CSA, ATEX, IEC Ex   |
| Actuator                       | Side rotary  | Side rotary   | Top plunger   |
| Pretravel (P.T.)               | 15°  | 15°   | 1,78 mm [0.070 in]  |
| Overtravel (O.T)               | 60°  | 60°   | 4,83 mm [0.190 in]  |
| Differential Travel (D.T.)     | 7°   | 7°  | 0,51 mm [0.020 in]  |
| UL File #                      | -  | -   | -   |
| CSA File #                     | -  | -   | -   |
| Operating Position (O.P.)      | -  | -   | 58.5 mm ± 0.76 mm [2.305 in ± 0.030 in]   |
| Sealing                        | IP67; NEMA 1, 3, 4, 6, 13  | IP67; NEMA 1, 3, 4, 6, 13   | I IP67; NEMA 1, 3, 4, 6, 13   |
| Product Type                   | Weather-sealed, explosion-proof limit switches/IEC Ex approvals  |   |   |
| Ampere Rating                  | 10 A (Thermal)   |   |   |
| Supply Voltage                 | 600 Vac and 250 Vdc max.   |   |   |
| Operating Temperature Range    | -40 °C to 70 °C [ -40 °F to 158 °F]  |   |   |
| Housing Material               | Zinc die-cast  |   |   |
| Housing Type                   | BX non plug-in   |   |   |
| Sealed                         | Explosion-proof  |   |   |
| Operating Force (O.F.)         | 0,45 N max. [4 in lb max.]   |   |   |
| Availability                   | Global   |   |   |
| Agency Approvals and Standards | UL, CSA, ATEX, IEC Ex; IP67; NEMA 1, 3, 4, 6, 13 (Div. 1, Class I, Groups B, C, & D • Div 1, Class II, Groups E, F, & G • II 2 G; Ex d IIC T6 • II 2 D; Ex d tD A21 T85°C) |   |   |

# Explosion-Proof Limit Switches

## SELECTION GUIDE

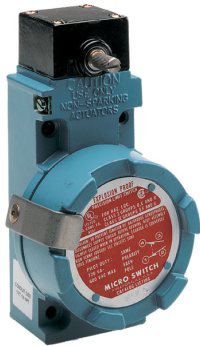
|                                       |  |  |   |
|---------------------------------------|--|--|---|
|                                       |   |  |  |
| <b>Features</b>                       | <b>BX4D3K</b>  | <b>BXA3K</b>   | <b>BXA4L</b>  |
| <b>Actuator</b>                       | N/A  | Lever not included - reference lever required accessory                            | Lever not included - reference lever required accessory                             |
| <b>Termination Type</b>               | 20mm conduit   | 1/2 in - 14NPT conduit   | 3/4 in - 14NPT conduit  |
| <b>Circuitry</b>                      | 1NC 1NO single-pole double-throw, snap-action, double-break  | 1NC 1NO single-pole double-throw, snap-action, double-break                        | 2NC 2NO single-pole double-throw, snap-Action, double-break                         |
| <b>Approvals</b>                      | UL, CSA, ATEX, IEC Ex  | UL, CSA, ATEX, IEC Ex  | UL, CSA, ATEX, IEC Ex   |
| <b>Actuator</b>                       | Top roller plunger   | Side rotary  | Side rotary   |
| <b>Pretravel (P.T.)</b>               | 1,78 mm [0.070 in]   | 15°  | 15°   |
| <b>Overtravel (O.T)</b>               | 4,83 mm [0.190 in]   | 60°  | 60°   |
| <b>Differential Travel (D.T.)</b>     | 0,51 mm [0.020 in]   | 7°   | 7°  |
| <b>UL File#</b>                       | -  | E61730   | E61730  |
| <b>CSA File #</b>                     | -  | LR57327  | LR57327   |
| <b>Operating Position (O.P.)</b>      | 68.6 mm ± 1 mm [2.700 in ± 0.040 in]   | -  | -   |
| <b>Sealing</b>                        | IP67; NEMA 1, 3, 4, 6, 13  | IP67; NEMA 1, 3, 4, 6, 13  | IP67; NEMA 1, 3, 4, 6, 13   |
| <b>Product Type</b>                   | Weather-sealed, explosion-proof limit switches/IEC Ex approvals  |  |   |
| <b>Ampere Rating</b>                  | 10 A (Thermal)   |  |   |
| <b>Supply Voltage</b>                 | 600 Vac and 250 Vdc max.   |  |   |
| <b>Operating Temperature Range</b>    | -40 °C to 70 °C [ -40 °F to 158 °F]  |  |   |
| <b>Housing Material</b>               | Zinc die-cast  |  |   |
| <b>Housing Type</b>                   | BX non-plug-in   |  |   |
| <b>Sealed</b>                         | Explosion-proof  |  |   |
| <b>Operating Force (O.F.)</b>         | 0,45 N max. [4 in lb max.]   |  |   |
| <b>Availability</b>                   | Global   |  |   |
| <b>Agency Approvals and Standards</b> | UL, CSA, ATEX, IEC Ex; IP67; NEMA 1, 3, 4, 6, 13 (Div. 1, Class I, Groups B, C, & D • Div 1, Class II, Groups E, F, & G • II 2 G; Ex d IIC T6 • II 2 D; Ex d tD A21 T85°C) |  |   |

# BX Series

MOUNTING DIMENSIONS (For reference only) mm/in



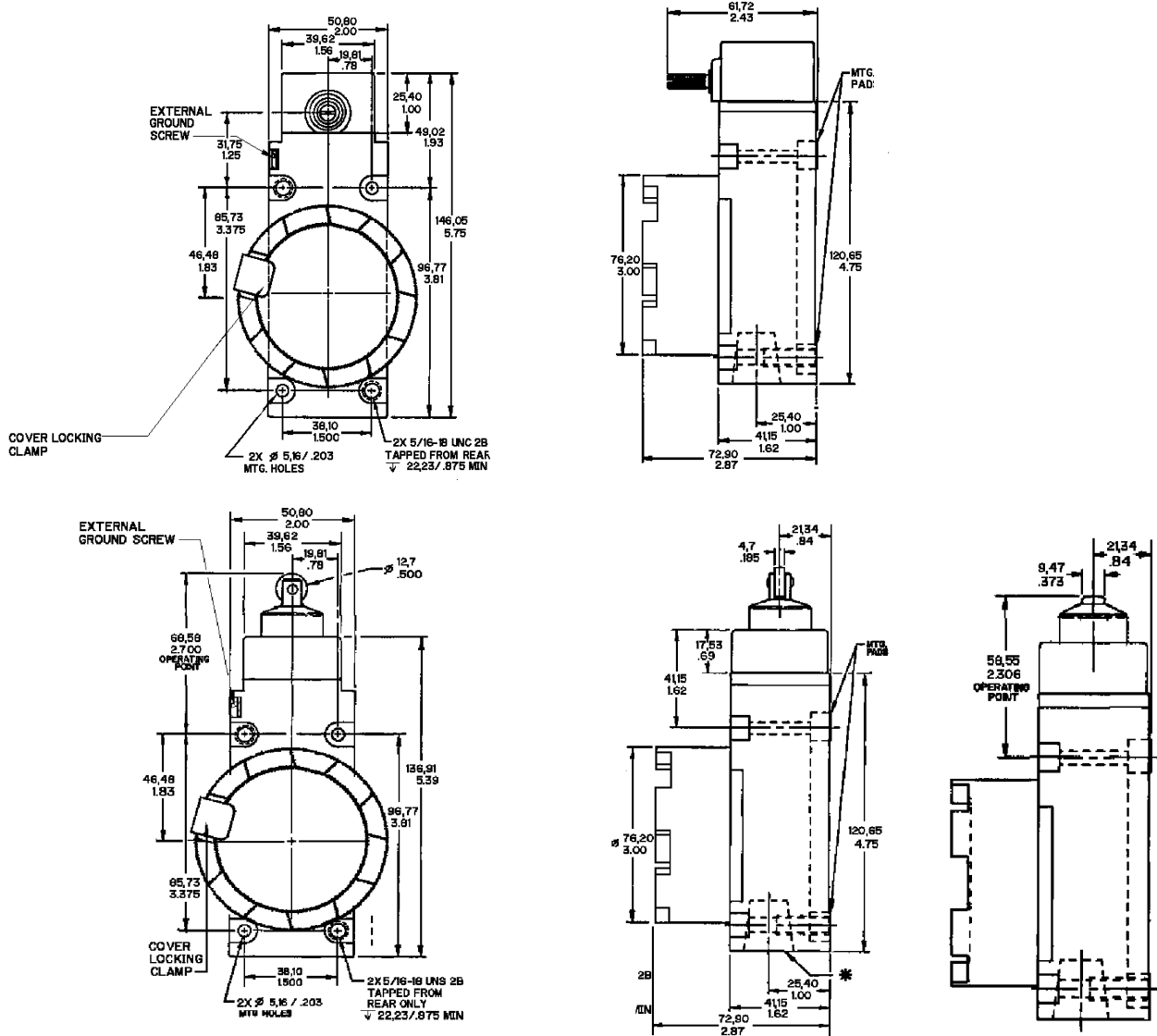

Fig. 1







Conduit sizes 1/2-14NPT, 3/4-14NPT, M20, PG13.5, PF1/2 are available for each switch type. Verify that the mating threaded fitting is identical with the conduit thread shown on the product nameplate

# Explosion-Proof Limit Switches

## LEVERS – REQUIRED ACCESSORIES

|                     |   |   |  |   |   |
|---------------------|---|---|--|---|---|
|                     |  |  |  |  |  |
|                     | <b>LSZ51A</b>   | <b>LSZ51C</b>   | <b>LSZ52C</b>  | <b>LSZ52J</b>   | <b>LSZ52K</b>   |
| <b>Lever style</b>  | Roller – standard   | Roller – standard   | Roller – adjustable  | Roller – adjustable   | Roller – adjustable   |
| <b>Comment</b>      | Roller - standard; material: nylon; roller mounted on front of lever              | Roller - standard; material: nylon; roller mounted on back of lever               | Roller - adjustable; material: nylon; roller mounted on front of lever             | Roller - adjustable; material: nylon; roller mounted on front of lever              | Roller - adjustable; material: nylon; roller mounted on front of lever              |
| <b>Radius</b>       | 38,1 mm<br>[1.5 in]   | 38,1 mm<br>[1.5 in]   | 38,1 mm to 88,9 mm<br>[1.5 in to 3.5 in]   | 38,1 mm to 88,9 mm<br>[1.5 in to 3.5 in]  | 38,1 mm to 88,9 mm<br>[1.5 in to 3.5 in]  |
| <b>Diameter</b>     | 19,05 mm<br>[0.75 in]   | 19,05 mm<br>[0.75 in]   | 19,05 mm<br>[0.75 in]  | 25,4 mm<br>[1.0 in]   | 38,1 mm<br>[1.5 in]   |
| <b>Width</b>        | 6,35 mm<br>[0.25 in]  | 6,35 mm<br>[0.25 in]  | 6,35 mm<br>[0.25 in]   | 12,7 mm<br>[0.5 in]   | 6,35 mm<br>[0.25 in]  |
| <b>Product type</b> | Lever   |   |  |   |   |
| <b>Availability</b> | Global  |   |  |   |   |

|                     |   |   |  |   |   |
|---------------------|---|---|--|---|---|
|                     |  |  |  |  |  |
|                     | <b>LSZ53E</b>   | <b>LSZ53S</b>   | <b>LSZ54M</b>  | <b>LSZ55A</b>   | <b>LSZ55C</b>   |
| <b>Lever style</b>  | Roller – yoke   | Roller – yoke   | Rod – standard   | Roller with offset  | Roller with offset  |
| <b>Comment</b>      | Roller - yoke; material: nylon; roller mounted on back-front of lever               | Roller - yoke; material: nylon; roller mounted on back-back of lever                | Rod - standard; material: aluminum; material: aluminum                               | Roller - with offset; material: nylon; roller mounted on back of lever                | Roller - with offset; material: nylon; roller mounted on front of lever               |
| <b>Radius</b>       | 38,1 mm<br>[1.5 in]   | 38,1 mm<br>[1.5 in]   | 139,7 mm<br>[5.5 in]   | 38,1 mm<br>[1.5 in]   | 38,1 mm<br>[1.5 in]   |
| <b>Diameter</b>     | 19,05 mm<br>[0.75 in]   | 19,05 mm<br>[0.75 in]   | -  | 19,05 mm<br>[0.75 in]   | 19,05 mm<br>[0.75 in]   |
| <b>Width</b>        | 6,35 mm<br>[0.25 in]  | 6,35 mm<br>[0.25 in]  | -  | 6,35 mm<br>[0.25 in]  | 6,35 mm<br>[0.25 in]  |
| <b>Product type</b> | Lever   |   |  |   |   |
| <b>Availability</b> | Global  |   |  |   |   |

## **WARNING**

### **PERSONAL INJURY**

DO NOT USE these products as safety or emergency stop devices or in any other application where failure of the product could result in personal injury.

**Failure to comply with these instructions could result in death or serious injury.**

## **WARNING**

### **OPENING PRODUCTS HAZARD**

DO NOT OPEN these products when energized or in a flammable gas atmosphere.

**Failure to comply with these instructions could result in death or serious injury.**

### **WARRANTY/REMEDY**

Honeywell warrants goods of its manufacture as being free of defective materials and faulty workmanship. Honeywell's standard product warranty applies unless agreed to otherwise by Honeywell in writing; please refer to your order acknowledgement or consult your local sales office for specific warranty details. If warranted goods are returned to Honeywell during the period of coverage, Honeywell will repair or replace, at its option, without charge those items it finds defective. **The foregoing is buyer's sole remedy and is in lieu of all other warranties, expressed or implied, including those of merchantability and fitness for a particular purpose. In no event shall Honeywell be liable for consequential, special, or indirect damages.**

While we provide application assistance personally, through our literature and the Honeywell web site, it is up to the customer to determine the suitability of the product in the application.

Specifications may change without notice. The information we supply is believed to be accurate and reliable as of this printing. However, we assume no responsibility for its use.

## **WARNING**

### **IMPROPER CONDUIT THREAD USE**

DO NOT USE any other conduit thread than the one identified on the product. Verify that the mating threaded fitting is identical with the conduit thread shown on the product nameplate.

**Failure to comply with these instructions could result in death or serious injury.**

## **WARNING**

### **MISUSE OF DOCUMENTATION**

- The information presented in this product sheet is for reference only. Do not use this document as a product installation guide.
- Complete installation, operation, and maintenance information is provided in the instructions supplied with each product.

**Failure to comply with these instructions could result in death or serious injury.**

### **SALES AND SERVICE**

Honeywell serves its customers through a worldwide network of sales offices, representatives and distributors. For application assistance, current specifications, pricing or name of the nearest Authorized Distributor, contact your local sales office or:

**E-mail:** [info.sc@honeywell.com](mailto:info.sc@honeywell.com)

**Internet:** [www.honeywell.com/sensing](http://www.honeywell.com/sensing)

#### **Phone and Fax:**

Asia Pacific +65 6355-2828  
+65 6445-3033 Fax  
Europe +44 (0) 1698 481481  
+44 (0) 1698 481676 Fax  
Latin America +1-305-805-8188  
+1-305-883-8257 Fax  
USA/Canada +1-800-537-6945  
+1-815-235-6847  
+1-815-235-6545 Fax

Sensing and Control  
Honeywell  
1985 Douglas Drive North  
Golden Valley, MN 55422  
[www.honeywell.com/sensing](http://www.honeywell.com/sensing)

002306-3-EN IL50 GLO Printed in USA  
July 2008  
Copyright © 2008 Honeywell International Inc. All rights reserved.

# Honeywell