

## LR14AD POWERLINE

DIMENSIONS (MM)

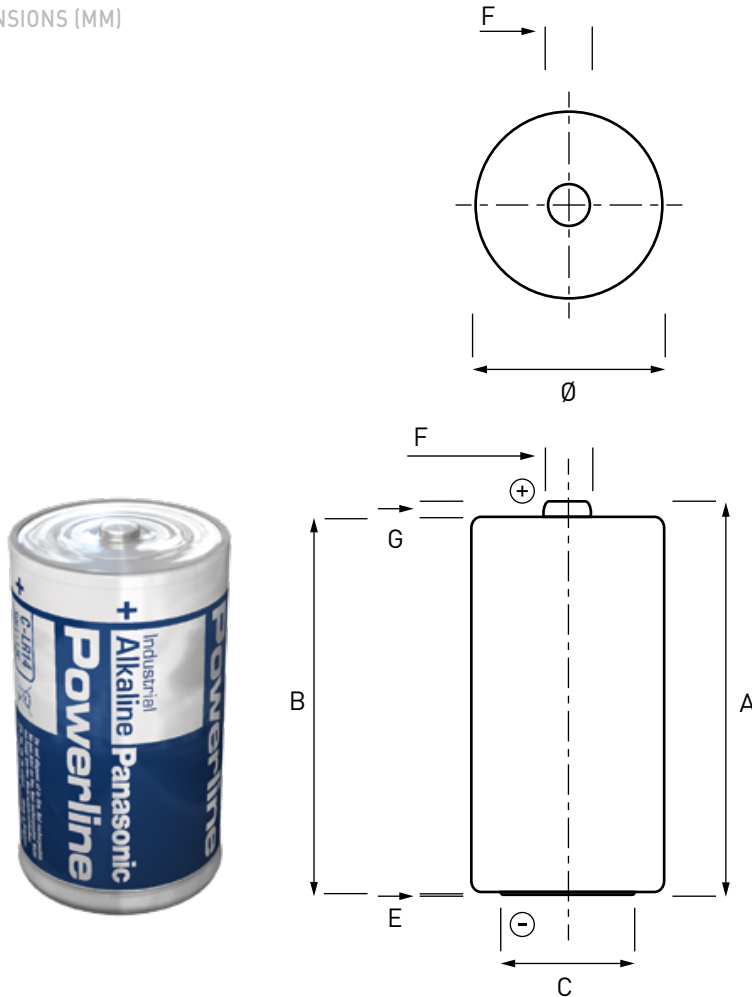

IEC dimensions	Maximum	Minimum
A	50.0	
B		48.6
C		13.0
E	0.9	
F	7.5	
G		1.5
Ø	26.2	24.9

<b>Specifications</b>	LR14 / L / C / AM2 / BABY / MN1400 / 14A / 14AC
<b>Made in</b>	Belgium
<b>Type</b>	Alkaline Foil
<b>Nominal voltage (V)</b>	1.5
<b>Electrolyte</b>	Potassium Hydroxide
<b>Average weight (g)</b>	66.0
<b>Storage temp. range</b>	+10°C [50°F] ~ + 25°C [77°F]
<b>Operating temp. range</b>	-20°C [-4°F] ~ + 55°C [131°F]
<b>Average Impedance</b>	+/- 100 m-Ω @ 1kHz fresh
<b>Heavy metals</b>	No added Mercury (Hg), Cadmium (Cd) or Lead (Pb)
<b>Compliant to</b>	IEC 60086-1, IEC 60086-2, IEC 60086-5 non dangerous goods regulation EC directive 91/157EC & 98/101EC Nordic Ecolabel
<b>Recommended cut off voltage</b>	0.8V per cell [0.9V per cell for multi series usage]

The information herein is believed to be correct. However no warranty is made, either expressed or implied, regarding the accuracy of the results to be obtained from the use of such information. Test results are strictly according to IEC conditions. Capacities of batteries depend on drain, temperature and cut-off voltage. Data are subject to change.

# LR14AD POWERLINE

## TYPICAL DISCHARGE VALUES

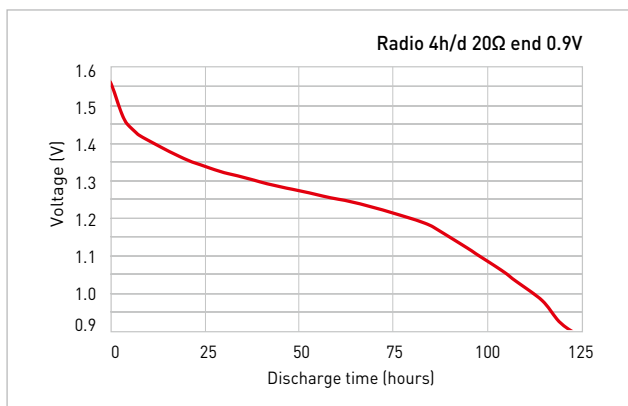
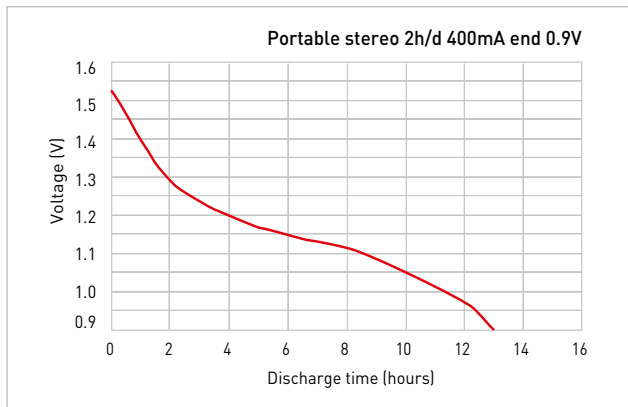
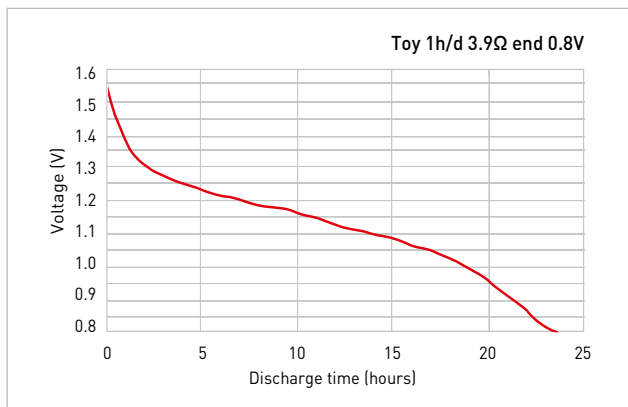
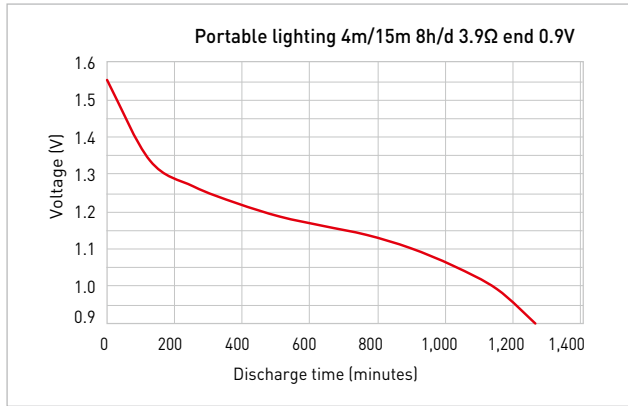

## DISCHARGE TEMPERATURE CHARACTERISTICS

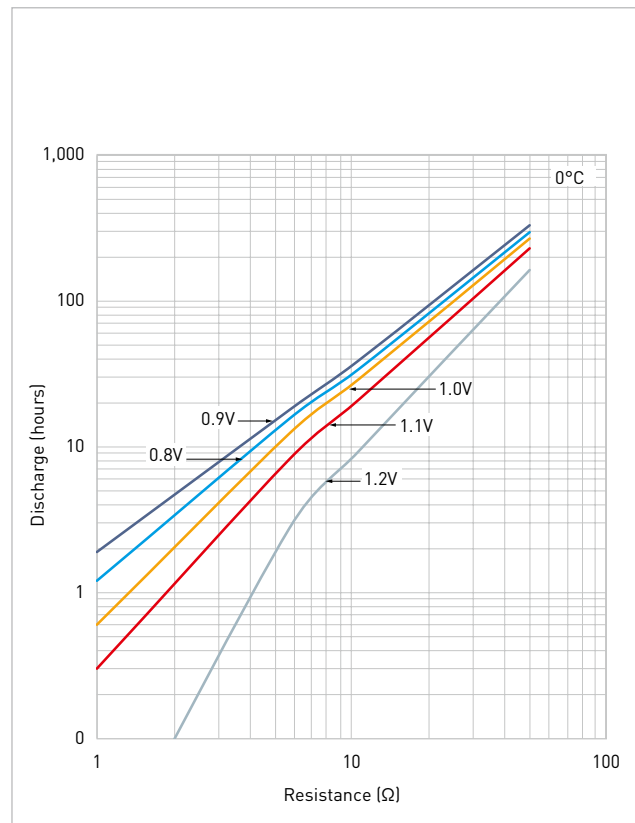
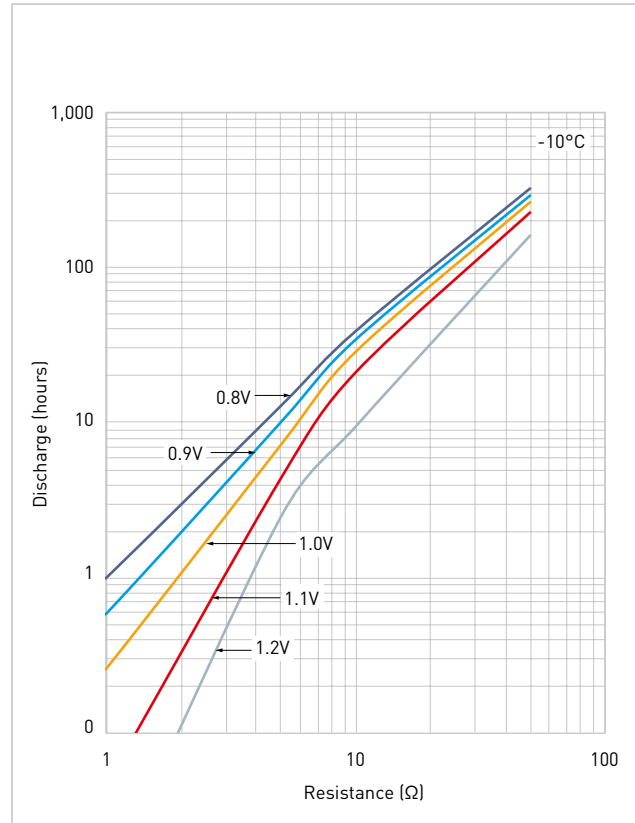

The information herein is believed to be correct. However no warranty is made, either expressed or implied, regarding the accuracy of the results to be obtained from the use of such information. Test results are strictly according to IEC conditions. Capacities of batteries depend on drain, temperature and cut-off voltage. Data are subject to change.

# LR14AD POWERLINE

## DISCHARGE TEMPERATURE CHARACTERISTICS

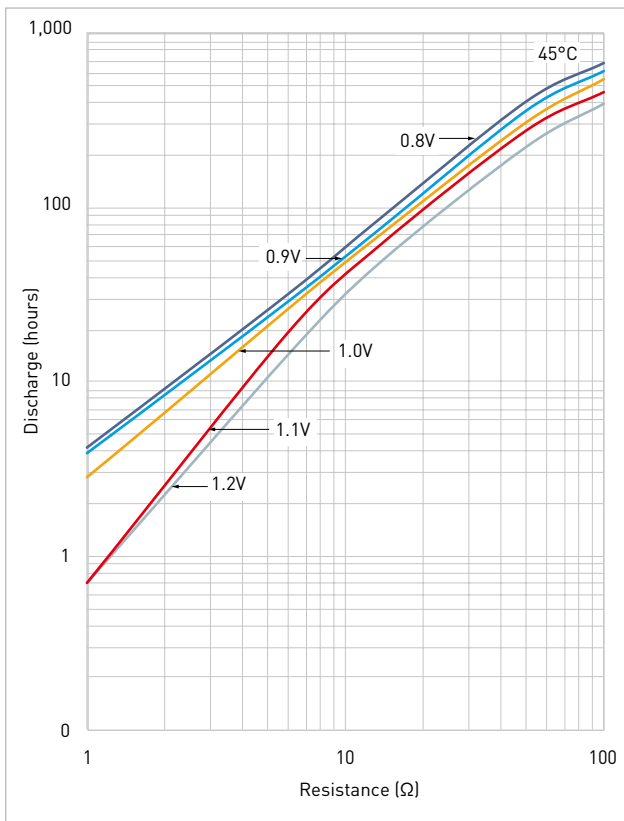
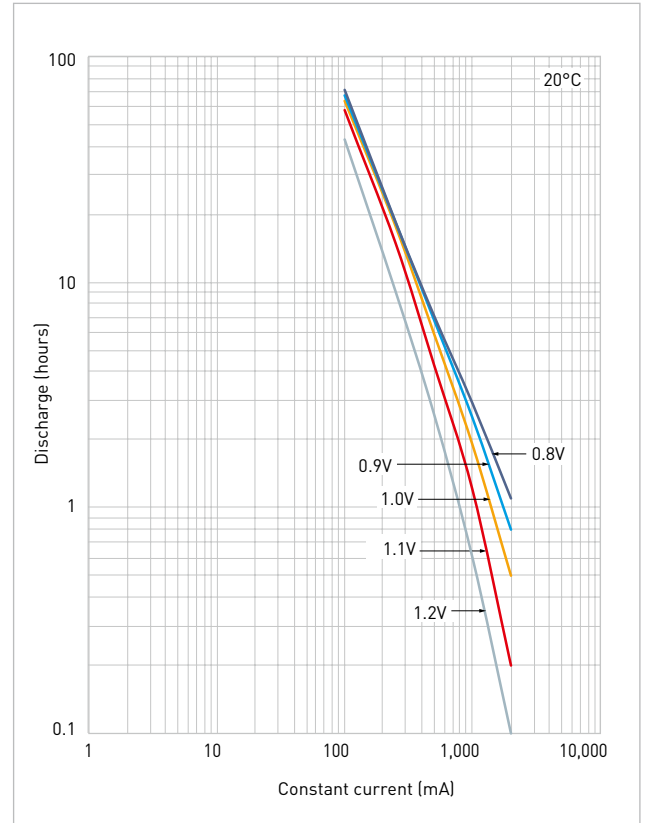
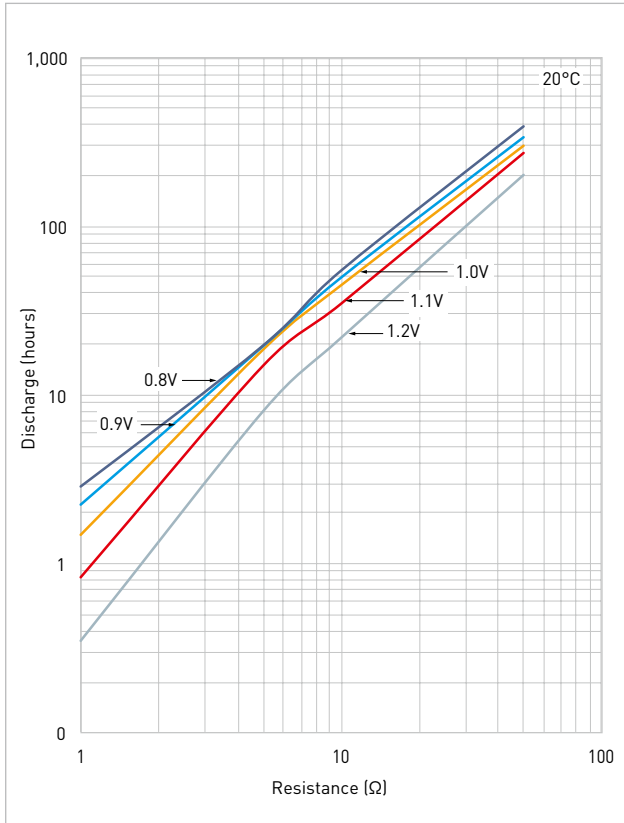

The information herein is believed to be correct. However no warranty is made, either expressed or implied, regarding the accuracy of the results to be obtained from the use of such information. Test results are strictly according to IEC conditions. Capacities of batteries depend on drain, temperature and cut-off voltage. Data are subject to change.