

## BN 1722 - DIN 985

Prevailing torque type hexagon lock nuts  
low type, with polyamide insert

DIN 985  
~UNI 7474

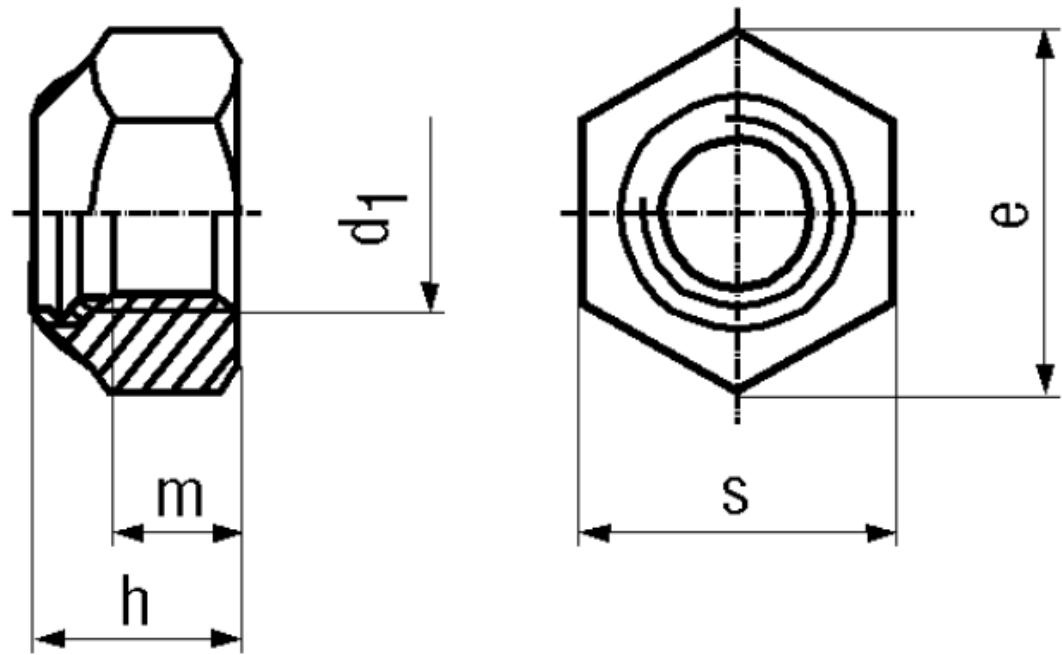

Material	<b>Stainless steel</b>	Quality	<b>A4</b>
----------	------------------------	---------	-----------

### Article No. - 1397222

$d_1$	M5
e min.	8,79
h max.	5
m	3,2
s	8

DIN 985: Standard withdrawn

Wrench size according to ISO on request.