

BN 4719

Hexagon socket flat countersunk
head screws
fully threaded
fully threaded

DIN 7991
~ISO 10642
~UNI 5933

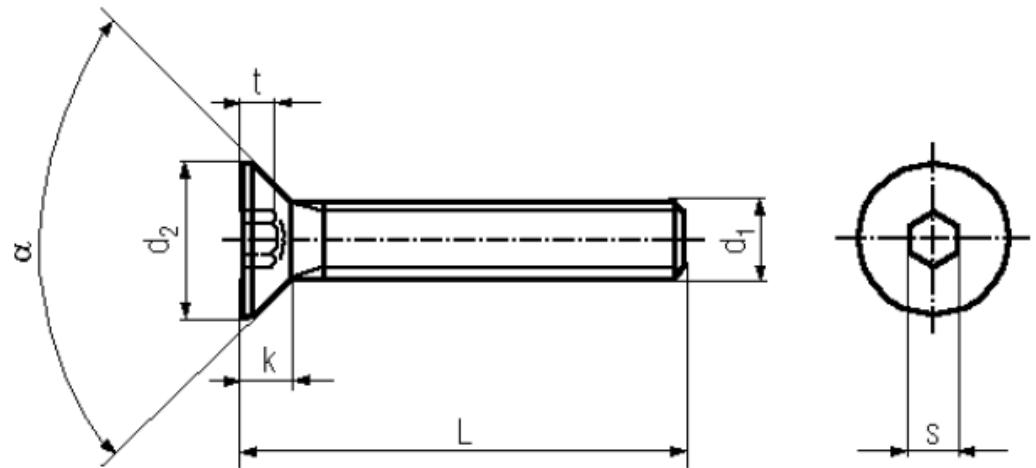

Material	Stainless steel	Quality	A4
----------	------------------------	---------	-----------

Article No. - 1100114

d ₁	M3
L	25
d ₂ max.	6
k max.	1,7
s	2
t	1,2
v	90

DIN 7991: Standard withdrawn

M2: M2,5; Not included in ISO 7991.