

ARTHERMO



General Catalogue

2013/2

Temperature under control

The Company

Arthermo has been making Measurement Instruments internationally for over 40 years. All of our products are manufactured with customary Italian style and quality.

We therefore have a wealth of experience and know-how which allows us to better tailor our products to the manufacturer's own specific needs. Service and Quality are the backbone of all our business relationships, which we are proud to have established over the decades.

Arthermo products cover many fields of application including the following:

- Refrigeration
- Washing
- Cooking
- Heating
- Floor heating

Arthermo production boasts high and consistent quality standards, thanks to advanced automation processes.

TEAMWORKING

The PEOPLE and the TEAM. The team Arthermo works together and everyone contributes to the company goals' achievement. The functions' rotation guarantees the total tasks covering also in the emerging events. The training is continuous to follow the last technical and commercial news. Our stakeholders are considered PEOPLE, like us. Thanks to this approach we are able to comprehend the real expectations at 100%. The brainstorming is considered a fundamental element of personal and professional growth.

SUPPLY CHAIN

The best customer service is obtained by searching reliable partners. Arthermo takes care about the changing market phases thanks to its global vision. Our loyalty, trust and honesty values are shared by the partnership defined which made Arthermo a real international company. The market is the king, the main actor to get vital informations.

ENGINEERING AND PRODUCTION

The customers' needs are the starting point of our solutions. We take care about the products' aesthetic and duration characteristics and we look for the best raw materials to guarantee the highest quality level. TOTAL QUALITY: a MUST in the design and production processes. The brand Arthermo means total control and testing: every product is checked at 100% to offer the maximum quality level. Our analogical range has a low impact on the environment: low consumption and long duration. Every new component is easily recyclable and with a low environmental impact.

ARTHERMO IN THE WORLD

The partnership in the Arthermo history created a global distribution network to guarantee the capillary presence in the market. Thanks to this global network, Arthermo is a real international company which cares about the different cultures to satisfy the competitive arena's needs and expectations.

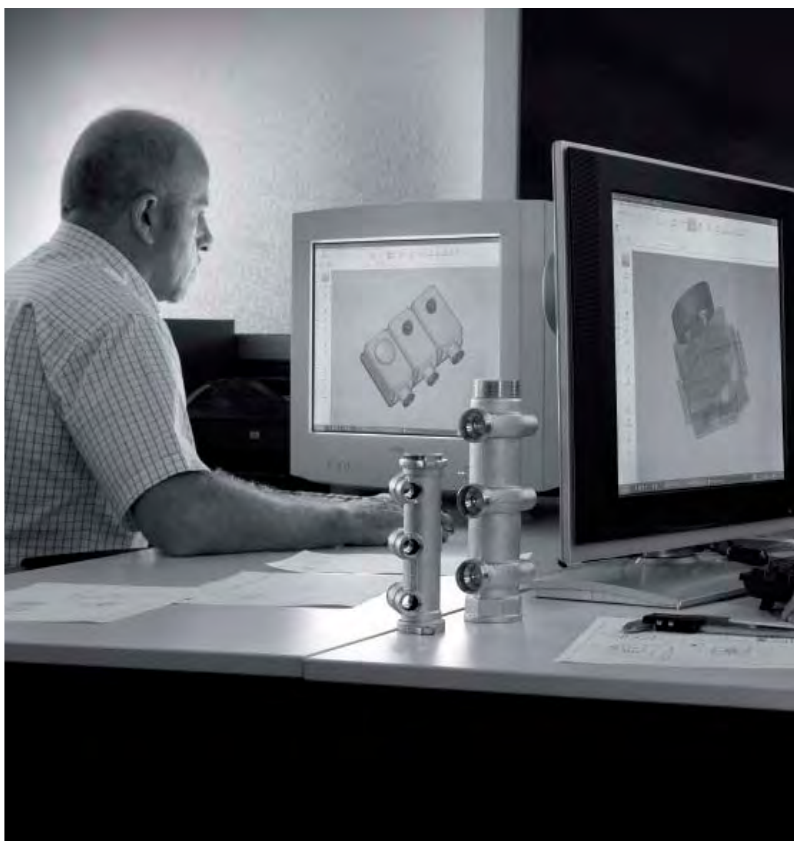

Index

Capillary Thermometers	Section 1	4
Oven Range	Section 2	8
Bimetallic Thermometers	Section 3	13
Thermostats	Section 4	21
Digital Instruments	Section 5	26
Heating and Sanitary	Section 6	30



ARTHERMO



Capillary Thermometers

Section 1

Capillary Thermometers

APPLICATIONS:

Boilers, refrigerators, restaurants service equipment and electrical appliances.

CHARACTERISTICS:

ABS or metal case, fixing with brackets or clips, standard capillary length: 1500 MM, thermometric movement with liquid expansion.



CP 05

Case diameter 52 mm

MODEL	CODE	TEMPERATURE RANGE	BOX	BOX DIMENSIONS (mm)	WEIGHT (kg)
CPF 05* ¹	270133340402	-40/+40° C	100	480x290x230	6
CP 05*	350133319602	0/120° C	100	480x290x230	6
CP 05 C	350135660202	50/350° C	250	660x400x250	12,5



CP 03

Case diameter 52 mm

MODEL	CODE	TEMPERATURE RANGE	BOX	BOX DIMENSIONS (mm)	WEIGHT (kg)
CPF 03 ¹	870133340102	-40/+40° C	250	660x400x250	14
CP 03	990133320102	0/120° C	250	660x400x250	14
CP 03 C	990135629002	50/350° C	250	660x400x250	14,5



CP 37

Case diameter 37 mm

MODEL	CODE	TEMPERATURE RANGE	BOX	BOX DIMENSIONS (mm)	WEIGHT (kg)
CPF 37 ¹	980133340102	-40/+40° C	250	660x400x250	12
CP 37*	980133319502	0/120° C	100	480x290x230	5



QP 03

Square case 48x48 mm

MODEL	CODE	TEMPERATURE RANGE	BOX	BOX DIMENSIONS (mm)	WEIGHT (kg)
QPF 03 ¹	614033340402	-40/+40° C	250	660x400x250	14
QP 03	443033319902	0/120° C	250	660x400x250	14



RO 88

Horizontal version, available also vertical and/or white.

Case 58x25x55 mm

MODEL	CODE	TEMPERATURE RANGE	BOX	BOX DIMENSIONS (mm)	WEIGHT (kg)
ROF 88 Black	883033340102	-40/+40° C	100	480x290x230	7
ROF 88 Black* ¹	883033342602	-40/+40° C	100	480x290x230	7
ROF 88 White	883233340102	-40/+40° C	100	480x290x230	7
ROF 88 White* ¹	883233342602	-40/+40° C	100	480x290x230	7
RO 88 Black*	732033320102	0/120° C	100	480x290x230	7
RO 88 C Black	734035668002	50/350° C	100	480x290x230	7

* Products normally available at stock.

¹ According to norm UNI EN 13485 "Thermometers for measuring the air and product temperature for the transport, storage and distribution of chilled, frozen, deep-frozen/quick frozen food and ice cream". Arthermo thermometers are manufactured with accuracy class 2 ($\pm 2^\circ\text{C}$) and resolution 1°C .



RO 2000

Horizontal version, available also vertical and/or white.

Case 58x25x45 mm

MODEL	CODE	TEMPERATURE RANGE	BOX	BOX DIMENSIONS (mm)	WEIGHT (kg)
ROF 2000 Black	960133340102	-40/+40° C	100	480x290x230	7
ROF 2000 White	960333340102	-40/+40° C	100	480x290x230	7
RO 2000 Black	740133363302	20/120° C	100	480x290x230	7
RO 2000 C Black	740135668002	50/350° C	100	480x290x230	7

RN

Horizontal version, available also vertical.

Case 62x11 mm



MODEL	CODE	TEMPERATURE RANGE	BOX	BOX DIMENSIONS (mm)	WEIGHT (kg)
RNF 1 Rounded Frame Black	560333352621	-30/+40° C	200	480x290x230	13
RNF 2 Rectangular Frame Black	570333352621	-30/+40° C	200	480x290x230	13
RNF 1 Rounded Frame White	560133352621	-30/+40° C	200	480x290x230	13
RNF 2 Rectangular Frame White	570133352621	-30/+40° C	200	480x290x230	13
RN 1 Rounded Frame Black	210233319502	0/120° C	200	480x290x230	13
RN 2 Rectangular Frame Black	212733319502	0/120° C	200	480x290x230	13
RN 1 Rounded Frame White	210133319502	0/120° C	200	480x290x230	13
RN 2 Rectangular Frame White	212633319502	0/120° C	200	480x290x230	13

C 71

Fixing brackets included, zinc plated steel case.



Diameter 52 mm

MODEL	CODE	TEMPERATURE RANGE	BOX	BOX DIMENSIONS (mm)	WEIGHT (kg)
CF 72 ¹	160133338802	-40/+40° C	100	660x400x250	16
C 71	130133328902	0/120° C	100	660x400x250	16
C 71 C	135035676002	50/350° C	100	660x400x250	16



Diameter 60 mm

MODEL	CODE	TEMPERATURE RANGE	BOX	BOX DIMENSIONS (mm)	WEIGHT (kg)
CF 72 ¹	170133338802	-40/+40° C	100	660x400x250	16
C 71	140133329002	0/120° C	100	660x400x250	16
C 71 C	145435675902	50/350° C	100	660x400x250	16

F 84 FA EC

Version with zinc plated steel case, available only with front flange.



Diameter 52 mm

MODEL	CODE	TEMPERATURE RANGE	BOX	BOX DIMENSIONS (mm)	WEIGHT (kg)
F 84 EC ¹	190133340402	-40/+40° C	150	660x400x250	18
F 84 EC	190133319502	0/120° C	150	660x400x250	18
F 84 EC	190234665002	50/350° C	150	660x400x250	20

¹ According to norm UNI EN 13485 "Thermometers for measuring the air and product temperature for the transport, storage and distribution of chilled, frozen, deep-frozen/quick frozen food and ice cream". Arthermo thermometers are manufactured with accuracy class 2 (± 2° C) and resolution 1° C.

F 84 FA*Metal front flange, resin hardened case.***Diameter 60 mm**

MODEL	CODE	TEMPERATURE RANGE	BOX	BOX DIMENSIONS (mm)	WEIGHT (kg)
F 84 FA ¹	220133040311	-40/+40° C	50	660x400x250	10
F 84 FA	220133019502	0/120° C	50	660x400x250	10
F 84 FA	220134663102	50/350° C	50	660x400x250	11

Diameter 80 mm

MODEL	CODE	TEMPERATURE RANGE	BOX	BOX DIMENSIONS (mm)	WEIGHT (kg)
F 84 FA ¹	230133040311	-40/+40° C	40	660x400x250	10
F 84 FA	230133019502	0/120° C	40	660x400x250	10
F 84 FA	230134663102	50/350° C	40	660x400x250	11

Diameter 100 mm

MODEL	CODE	TEMPERATURE RANGE	BOX	BOX DIMENSIONS (mm)	WEIGHT (kg)
F 84 FA ¹	240133040211	-40/+40° C	30	660x400x250	11
F 84 FA	240133019502	0/120° C	30	660x400x250	11
F 84 FA	240134665002	50/350° C	30	660x400x250	12

**F 84 FP***Version with back flange, resin hardened case.***Diameter 60 mm**

MODEL	CODE	TEMPERATURE RANGE	BOX	BOX DIMENSIONS (mm)	WEIGHT (kg)
F 84 FP ¹	290133040111	-40/+40° C	50	660x400x250	10
F 84 FP	290133019602	0/120° C	50	660x400x250	10
F 84 FP	290134666102	50/350° C	50	660x400x250	11

Diameter 80 mm

MODEL	CODE	TEMPERATURE RANGE	BOX	BOX DIMENSIONS (mm)	WEIGHT (kg)
F 84 FP ¹	300133040411	-40/+40° C	40	660x400x250	10
F 84 FP	300133019802	0/120° C	40	660x400x250	10
F 84 FP	300134666102	50/350° C	40	660x400x250	11

Diameter 100 mm

MODEL	CODE	TEMPERATURE RANGE	BOX	BOX DIMENSIONS (mm)	WEIGHT (kg)
F 84 FP ¹	310133040211	-40/+40° C	30	660x400x250	10
F 84 FP	310133019802	0/120° C	30	660x400x250	10
F 84 FP	310134666902	50/350° C	30	660x400x250	11

**F 87 R***Case and reversible flange in ABS.***Diameter 60 mm**

MODEL	CODE	TEMPERATURE RANGE	BOX	BOX DIMENSIONS (mm)	WEIGHT (kg)
F 87 RF* ¹	910133040111	-40/+40° C	150	670x430x550	22
F 87 R	910133019502	0/120° C	150	670x430x550	22
F 87 RC	910134667002	50/350° C	150	670x430x550	22

Diameter 80 mm

MODEL	CODE	TEMPERATURE RANGE	BOX	BOX DIMENSIONS (mm)	WEIGHT (kg)
F 87 RF* ¹	920133040111	-40/+40° C	80	670x430x550	16
F 87 R	920133019502	0/120° C	80	670x430x550	16
F 87 RC	920134667002	50/350° C	80	670x430x550	16

Diameter 100 mm

MODEL	CODE	TEMPERATURE RANGE	BOX	BOX DIMENSIONS (mm)	WEIGHT (kg)
F 87 RF* ¹	930133040111	-40/+40° C	80	670x430x550	19
F 87 R	930133019502	0/120° C	80	670x430x550	19
F 87 RC	930134667002	50/350° C	80	670x430x550	19



* Products normally available at stock.

¹ According to norm UNI EN 13485 "Thermometers for measuring the air and product temperature for the transport, storage and distribution of chilled, frozen, deep-frozen/quick frozen food and ice cream". Arthermo thermometers are manufactured with accuracy class 2 ($\pm 2^\circ\text{C}$) and resolution 1°C .

ARTHERMO



Oven Range

Section 2

Capillary Thermometers 0/500° C Ø 52 - Ø 60 - Ø 80

NEW

APPLICATIONS: Ovens, stoves, grills, barbecues, chimneys.

MATERIALS

Case	Zinc plated steel
Window	Glass
Pointer	Aluminium
Capillary/Bulb	Stainless steel mm 1000
Frame	S.S. AISI 304
Fixing	C71: With brackets F84: FA front flange

TECHNICAL SPECIFICATIONS

Norm	EN 13190
Temperature limits	Ambient: -20/+60° C Storage: -20/+60° C
Range	0/500° C
Working temperature	+50/+450° C
Accuracy class	2
Degree of protection	IP53 (on request IP63 thermometer)
Thermometric movements	By gas expansion

Mod. C71 OVEN

STANDARD VERSION



MODEL	CODE	Ø (mm)	Ø flange (mm)	TEMPERATURE RANGE	BOX	BOX DIMENSIONS (mm)	WEIGHT (kg)
C 71 OVEN	092023986153	52		0-500° C	100	660x400x250	16
C 71 OVEN	092523986153	60		0-500° C	100	660x400x250	16
C 71 OVEN	093023986153	80		0-500° C	60	660X400X250	18
F84 OVEN	091023986153	52		0-500° C	150	660x400x250	20
F 84 OVEN	091523986153	60	80	0-500° C	120	660x400x250	20
F 84 OVEN	091723986153	60	85	0-500° C	120	660x400x250	20

Mod. F84 OVEN

GOLD PLATED VERSION



MODEL	CODE	Ø (mm)	Ø flange (mm)	TEMPERATURE RANGE	BOX	BOX DIMENSIONS (mm)	WEIGHT (kg)
C 71 OVEN	092123986153	52		0-500° C	100	660x400x250	16
C 71 OVEN	092623986153	60		0-500° C	100	660x400x250	16
C 71 OVEN	093123986153	80		0-500° C	60	660X400X250	18
F84 OVEN	091123986153	52		0-500° C	150	660x400x250	20
F 84 OVEN	091623986153	60	80	0-500° C	120	660x400x250	20
F 84 OVEN	091823986153	60	85	0-500° C	120	660x400x250	20

Capillary Thermometers 0/600° C Ø 52 - Ø 60 - Ø 80

NEW

APPLICATIONS: Ovens, stoves, grills, barbecues, chimneys.

MATERIALS

Case	Zinc plated steel
Window	Glass
Pointer	Aluminium
Capillary/Bulb	Stainless steel mm 1000
Frame	S.S. AISI 304
Fixing	C71: With brackets F84: FA front flange

TECHNICAL SPECIFICATIONS

Norm	EN 13190
Temperature limits	Ambient: -20/+60° C Storage: -20/+60° C
Range	0/600° C
Working temperature	+50/+500° C
Accuracy class	2
Degree of protection	IP53 (on request IP63 thermometer)
Thermometric movements	By gas expansion

Mod. C71 OVEN



STANDARD VERSION

MODEL	CODE	Ø (mm)	Ø flange (mm)	TEMPERATURE RANGE	BOX	BOX DIMENSIONS (mm)	WEIGHT (kg)
C71 OVEN	092023986053	52		0/600° C	100	660x400x250	16
C71 OVEN	092523986053	60		0/600° C	100	660x400x250	16
C71 OVEN	093023986053	80		0/600° C	60	660x400x250	18
F84 OVEN	091023986053	52		0/600° C	150	660x400x250	20
F84 OVEN	091523986053	60	80	0/600° C	120	660x400x250	20
F84 OVEN	091723986053	60	85	0/600° C	120	660x400x250	20

Mod. F84 OVEN



GOLD PLATED VERSION

MODEL	CODE	Ø (mm)	Ø flange (mm)	TEMPERATURE RANGE	BOX	BOX DIMENSIONS (mm)	WEIGHT (kg)
C 71 OVEN	092123986053	52		0-600° C	100	660x400x250	16
C 71 OVEN	092623986053	60		0-600° C	100	660x400x250	16
C 71 OVEN	093123986053	80		0-600° C	60	660x400x250	18
F84 OVEN	091123986053	52		0-600° C	150	660x400x250	20
F 84 OVEN	091623986053	60	80	0-600° C	120	660x400x250	20
F84 OVEN	091823986053	60	85	0-600° C	120	660x400x250	20

Timer 60 Min. Ø 60

APPLICATIONS: Ovens, stoves, grills, barbecues, chimneys.

TIMER C71 Ø 60



TIMER 60 MIN.

MODEL	CODE	Ø flange (mm)	BOX	BOX DIMENSIONS (mm)	WEIGHT (kg)
TIMER C71 OVEN	TIMER60/01C71		100	660x400x250	16
TIMER F84 OVEN	TIMER60/0180	80	120	660x400x250	20
TIMER F84 OVEN	TIMER60/0185	85	120	660x400x250	20

TIMER F84 Ø 60



GOLD PLATED TIMER 60 MIN.

MODEL	CODE	Ø flange (mm)	BOX	BOX DIMENSIONS (mm)	WEIGHT (kg)
TIMER C71 OVEN GOLD	TIMER60/01C71G		100	660x400x250	16
TIMER F84 OVEN GOLD	TIMER60/0180G	80	120	660x400x250	20
TIMER F84 OVEN GOLD	TIMER60/0185G	85	120	660x400x250	20

Bimetallic Thermometers Ø 40 - Ø 50 - Ø 65

APPLICATIONS: Ovens, stoves, grills, barbecues, chimneys.

MATERIALS

Case	Zinc plated steel
Window	Glass
Dial	Aluminium
Pointer	Aluminium
Stem	Zinc plated steel Ø 9 mm or brass
Temperature element	Bimetallic, spiralled

TECHNICAL SPECIFICATIONS

Norm	EN 13190
Temperature limits	Ambient: -20/+60° C Storage: -20/+60° C
Operating temperature	As per dial indication
Accuracy class	2
Degree of protection	IP41 per EN 60 529/IEC 529



MOD. 569



A) DIRECT IMMERSION

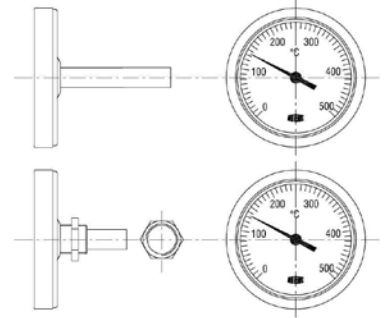

B) G1/4" THREADED WITH NUT

TYPE	CODE	STEM (mm)	TEMPERATURE RANGE	BOX	BOX DIMENSIONS (mm)	WEIGHT (kg)
AR569-T/B 40	024207438500	20 threaded	0-500°C	350	600x400x200	11,6
AR569-T/B 40	024209138500	27	0-500°C	350	600x400x200	11,6
AR569-T/B 40	024227938500	50	0-500°C	280	600x400x200	14,2
AR569-T/B 50	030109139600	27	0-500°C	350	600x400x200	17,7
AR569-T/B 50	030127939600	50	0-500°C	280	600x400x200	15,8
AR569-T/B 50	030151739600	100	0-500°C	200	660x400x250	16,0
AR569-T/B 65	040127939100	50	0-500°C	120	600x400x200	10,8
AR569-T/B 65	040151739100	100	0-500°C	150	660x400x250	14,0
AR569-T/B 65	040165039100	150	0-500°C	120	660x400x250	12,5
AR569-T/B 65	040169639100	200	0-500°C	100	660x400x250	12,5
AR569-T/B 65	040177239100	300	0-500°C	100	660x400x250	13,5
AR569-T/B 65	040179439100	400	0-500°C	100	660x400x250	14,5

Accessories

Clip, coop spring, gasket.:



MODEL	CODE
COOP SPRING	05034016201
CLIP SPRING	05034205PTZ
GASKET Ø40	17139252048
GASKET Ø50	17139250042
GASKET Ø65	17139250050

On request: threaded stem + nut +23% on pricelist

Bimetallic Old Style

APPLICATIONS: Ovens, stoves, grills, barbecues, chimneys.

TECHNICAL SPECIFICATIONS

	CIRCBELL	PANEL	POINTER	ARTH-COOK
CODE	013100000000	014100000100	012400000000	100100004000
CASE	Inox Aisi 430	Inox Aisi 430	Chrome-plated brass	Inox Aisi 430
KNOB	Alluminium	Alluminium	-	-
ROTATING INDEX	Metallic	Metallic	Metallic	Metallic
STANDARD ROTATING INDEX	Anticlockwise	Clockwise	Anticlockwise	Clockwise
ON DEMAND	Clockwise	-	Clockwise	-
WORKING TEMPERATURE	300°C	300°C	300°C	300°C
GASKET			Klinger	-
QTY/BOX	500	500	500	250

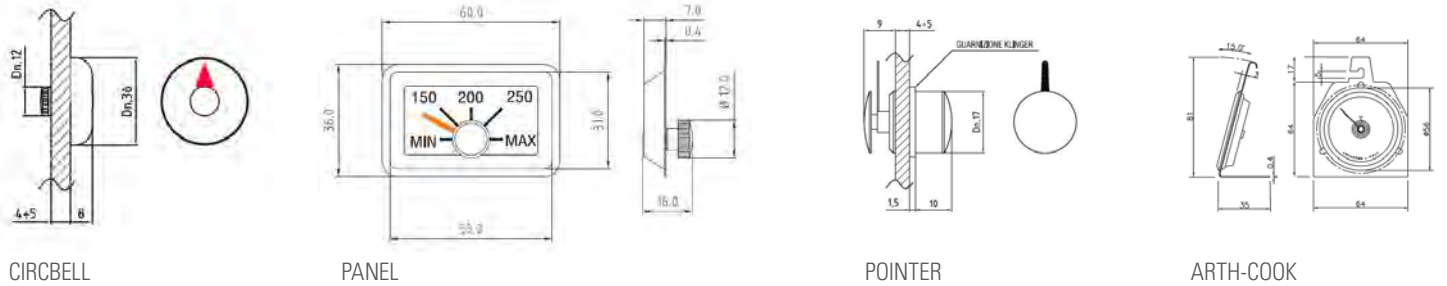

Digital Controller

APPLICATIONS: Ovens, stoves, grills, barbecues, chimneys.

CO-600



TECHNICAL SPECIFICATIONS

Range	0/600° C
Power supply	230 VAC ± 10% 50/60 Hz
Power consumption	<3 VA
Accuracy	± 1° C
Probe	N.1 - PT1000 on demand
Output	N.1 relay: 30A 230 VAC ± 10%
Panel size	75x34,5 mm
Installing size	71x29 mm
Ambient temperature	-10/+60° C
Relative humidity	20%/+85%
Qty/Box	50



ARTHERMO



Bimetallic Thermometers

Section 3

Bimetallic Thermometers with Zinc Plated Steel Case

APPLICATIONS: Heating, floor heating, conditioning, boilers, ovens, stoves, chimneys and electrical appliances.

FIG. 569 Ø 32 Ø 40

Zinc plated steel case, back stem.

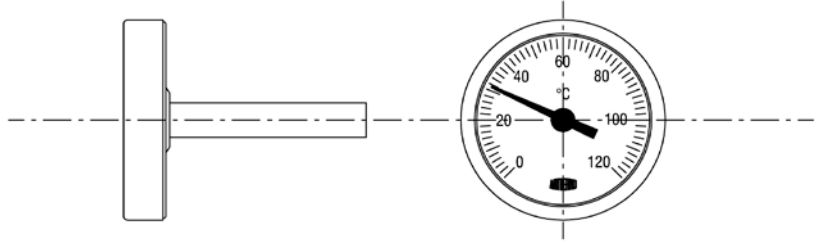

MATERIALS

Case	Zinc plated steel
Window	Clear resin/glass
Dial	Aluminium
Pointer	Resin/aluminium
Stem	Zinc plated steel Ø 9 mm
Temperature element	Bimetallic, spiralled

TECHNICAL SPECIFICATIONS

Design	UNI EN 13190
Temperature limits	Ambient: -20/+60° C Storage: -20/+60° C
Operating temperature	As per scale indication
Accuracy class	2
Degree of protection	IP41 per EN 60 529/IEC 529

Diameter 32 mm

TYPE	CODE	STEM (mm)	TEMPERATURE RANGE	BOX	BOX DIMENSIONS (mm)	WEIGHT (kg)
AR-T/B 32	020109116200	27	0-80° C	350	600x400x200	11,7
AR-T/B 32	020109119700	27	0-120° C	350	600x400x200	11,7
AR-T/B 32	020109129100	27	0-200° C	350	600x400x200	11,7
AR-T/B 32		27	0-300° C	350	600x400x200	11,7
AR-T/B 32		27	0-400° C	350	600x400x200	11,7
AR-T/B 32	020127916200	50	0-80° C	280	600x400x200	12
AR-T/B 32	020127919700	50	0-120° C	280	600x400x200	12
AR-T/B 32	020127929100	50	0-200° C	280	600x400x200	12
AR-T/B 32	020127934500	50	0-300° C	280	600x400x200	12
AR-T/B 32	020127936500	50	0-400° C	280	600x400x200	12

Diameter 40 mm

TYPE	CODE	STEM (mm)	TEMPERATURE RANGE	BOX	BOX DIMENSIONS (mm)	WEIGHT (kg)
AR-T/B 40	024207438500	20 threaded	0-500° C	350	600x400x200	11,6
AR-T/B 40		27	0-60° C	350	600x400x200	11,6
AR-T/B 40	024209116100	27	0-80° C	350	600x400x200	11,6
AR-T/B 40	024209119800	27	0-120° C	350	600x400x200	11,6
AR-T/B 40		27	0-160° C	350	600x400x200	11,6
AR-T/B 40	024209134500	27	0-300° C	350	600x400x200	11,6
AR-T/B 40		27	0-400° C	350	600x400x200	11,6
AR-T/B 40	024209138500	27	0-500° C	350	600x400x200	11,6
AR-T/B 40		50	0-60° C	280	600x400x200	14,2
AR-T/B 40	024227916100	50	0-80° C	280	600x400x200	14,2
AR-T/B 40	024227919800	50	0-120° C	280	600x400x200	14,2
AR-T/B 40		50	0-160° C	280	600x400x200	14,2
AR-T/B 40	024227929100	50	0-300° C	280	600x400x200	14,2
AR-T/B 40		50	0-400° C	280	600x400x200	14,2
AR-T/B 40	024227938500	50	0-500° C	280	600x400x200	14,2

On request: different stem length
On request: threaded stem + nut +23% on pricelist

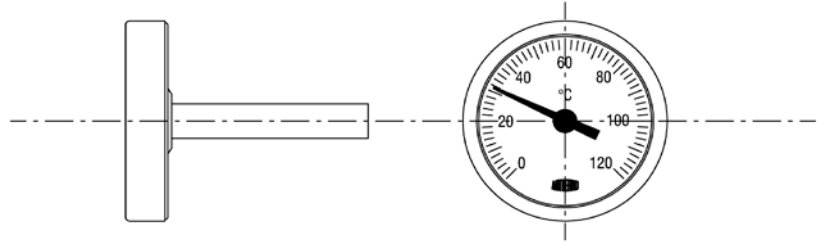
FIG. 569 Ø 50*Zinc plated steel case, back stem.***MATERIALS**

Case	Zinc plated steel
Window	Clear resin/glass
Dial	Aluminium
Pointer	Resin/aluminium
Stem	Zinc plated steel Ø 9 mm
Temperature element	Bimetallic, spiralled

TECHNICAL SPECIFICATIONS

Design	UNI EN 13190
Temperature limits	Ambient: -20/+60° C Storage: -20/+60° C
Operating temperature	As per scale indication
Accuracy class	2
Degree of protection	IP41 per EN 60 529/IEC 529

Diameter 50 mm

TYPE	CODE	STEM (mm)	TEMPERATURE RANGE	BOX	BOX DIMENSIONS (mm)	WEIGHT (kg)
AR-T/B 50		27	0-60° C	350	600x400x200	17,7
AR-T/B 50		27	0-80° C	350	600x400x200	17,7
AR-T/B 50	030109119800	27	0-120° C	350	600x400x200	17,7
AR-T/B 50	030109124000	27	0-160° C	350	600x400x200	17,7
AR-T/B 50	030109134500	27	0-300° C	350	600x400x200	17,7
AR-T/B 50		27	0-400° C	350	600x400x200	17,7
AR-T/B 50		27	0-500° C	350	600x400x200	17,7
AR-T/B 50		50	0-60° C	280	600x400x200	15,8
AR-T/B 50		50	0-80° C	280	600x400x200	15,8
AR-T/B 50	030127919800	50	0-120° C	280	600x400x200	15,8
AR-T/B 50	030127924000	50	0-160° C	280	600x400x200	15,8
AR-T/B 50	030127934500	50	0-300° C	280	600x400x200	15,8
AR-T/B 50		50	0-400° C	280	600x400x200	15,8
AR-T/B 50		50	0-500° C	280	600x400x200	15,8
AR-T/B 50		100	0-60° C	200	660x400x250	16
AR-T/B 50	030151718000	100	0-80° C	200	660x400x250	16
AR-T/B 50	030151719800	100	0-120° C	200	660x400x250	16
AR-T/B 50	030151724000	100	0-160° C	200	660x400x250	16
AR-T/B 50	030151734500	100	0-300° C	200	660x400x250	16
AR-T/B 50	030151736400	100	0-400° C	200	660x400x250	16
AR-T/B 50	030151739600	100	0-500° C	200	660x400x250	16

On request: different stem length

On request: threaded stem + nut +23% on pricelist

FIG. 569 Ø 65

Zinc plated steel case, back stem.

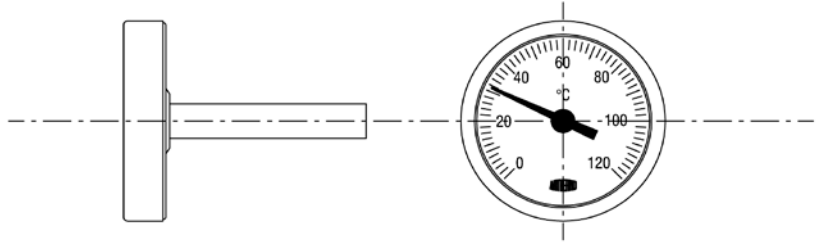

MATERIALS

Case	Zinc plated steel
Window	Clear resin/glass
Dial	Aluminium
Pointer	Resin/aluminium
Stem	Zinc plated steel Ø 9 mm
Temperature element	Bimetallic, spiralled

TECHNICAL SPECIFICATIONS

Design	UNI EN 13190
Temperature limits	Ambient: -20/+60° C Storage: -20/+60° C
Operating temperature	As per scale indication
Accuracy class	2
Degree of protection	IP41 per EN 60 529/IEC 529

Diameter 65 mm

TYPE	CODE	STEM (mm)	TEMPERATURE RANGE	BOX	BOX DIMENSIONS (mm)	WEIGHT (kg)
AR-T/B 65	040127915100	50	0-60° C	120	600x400x200	10,8
AR-T/B 65		50	0-80° C	120	600x400x200	10,8
AR-T/B 65	040127919900	50	0-120° C	120	600x400x200	10,8
AR-T/B 65	040127924200	50	0-160° C	120	600x400x200	10,8
AR-T/B 65	040127934100	50	0-300° C	120	600x400x200	10,8
AR-T/B 65		50	0-400° C	120	600x400x200	10,8
AR-T/B 65	040127939100	50	0-500° C	120	600x400x200	10,8
AR-T/B 65	040151715100	100	0-60° C	150	660x400x250	14
AR-T/B 65		100	0-80° C	150	660x400x250	14
AR-T/B 65	040151719900	100	0-120° C	150	660x400x250	14
AR-T/B 65	040151724200	100	0-160° C	150	660x400x250	14
AR-T/B 65	040151734100	100	0-300° C	150	660x400x250	14
AR-T/B 65		100	0-400° C	150	660x400x250	14
AR-T/B 65	040151739100	100	0-500° C	150	660x400x250	14
AR-T/B 65		150	0-60° C	120	660x400x250	12,5
AR-T/B 65		150	0-80° C	120	660x400x250	12,5
AR-T/B 65	040165019900	150	0-120° C	120	660x400x250	12,5
AR-T/B 65	040165024200	150	0-160° C	120	660x400x250	12,5
AR-T/B 65	040165034100	150	0-300° C	120	660x400x250	12,5
AR-T/B 65		150	0-400° C	120	660x400x250	12,5
AR-T/B 65	040165039100	150	0-500° C	120	660x400x250	12,5
AR-T/B 65		200	0-60° C	100	660x400x250	12,5
AR-T/B 65		200	0-80° C	100	660x400x250	12,5
AR-T/B 65	040169619900	200	0-120° C	100	660x400x250	12,5
AR-T/B 65	040169624200	200	0-160° C	100	660x400x250	12,5
AR-T/B 65	040169634100	200	0-300° C	100	660x400x250	12,5
AR-T/B 65		200	0-400° C	100	660x400x250	12,5
AR-T/B 65	040169639100	200	0-500° C	100	660x400x250	12,5
AR-T/B 65		300	0-60° C	100	660x400x250	13,5
AR-T/B 65		300	0-80° C	100	660x400x250	13,5
AR-T/B 65	040177219900	300	0-120° C	100	660x400x250	13,5
AR-T/B 65	040177224200	300	0-160° C	100	660x400x250	13,5
AR-T/B 65	040177234100	300	0-300° C	100	660x400x250	13,5
AR-T/B 65		300	0-400° C	100	660x400x250	13,5
AR-T/B 65	040177239100	300	0-500° C	100	660x400x250	13,5
AR-T/B 65		400	0-400° C	100	660x400x250	14,5
AR-T/B 65	040179439100	400	0-500° C	100	660x400x250	14,5

On request: different stem length
On request: threaded stem + nut +23% on pricelist

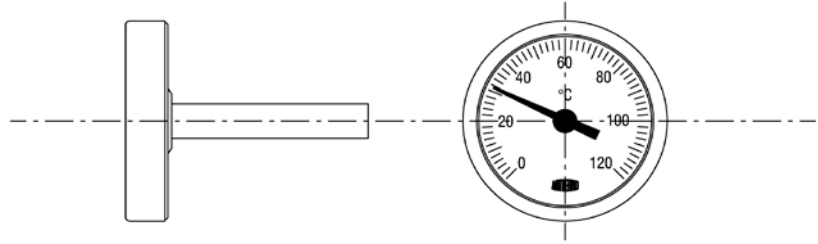
FIG. 569 Ø 80*Zinc plated steel case, back stem.***MATERIALS**

Case	Zinc plated steel
Window	Clear resin/glass
Dial	Aluminium
Pointer	Resin/aluminium
Stem	Zinc plated steel Ø 9 mm
Temperature element	Bimetallic, spiralled

TECHNICAL SPECIFICATIONS

Design	UNI EN 13190
Temperature limits	Ambient: -20/+60° C Storage: -20/+60° C
Operating temperature	As per scale indication
Accuracy class	2
Degree of protection	IP41 per EN 60 529/IEC 529

Diameter 80 mm

TYPE	CODE	STEM (mm)	TEMPERATURE RANGE	BOX	BOX DIMENSIONS (mm)	WEIGHT (kg)
AR-T/B 80	050127916000	50	0-60° C	120	600x400x200	15,2
AR-T/B 80		50	0-80° C	120	600x400x200	15,2
AR-T/B 80	050127920000	50	0-120° C	120	600x400x200	15,2
AR-T/B 80		50	0-160° C	120	600x400x200	15,2
AR-T/B 80	050127935000	50	0-300° C	120	600x400x200	15,2
AR-T/B 80		50	0-400° C	120	600x400x200	15,2
AR-T/B 80	050127938400	50	0-500° C	120	600x400x200	15,2
AR-T/B 80	050151716000	100	0-60° C	150	660x400x250	19,5
AR-T/B 80		100	0-80° C	150	660x400x250	19,5
AR-T/B 80	050151720000	100	0-120° C	150	660x400x250	19,5
AR-T/B 80		100	0-160° C	150	660x400x250	19,5
AR-T/B 80	050151735000	100	0-300° C	150	660x400x250	19,5
AR-T/B 80		100	0-400° C	150	660x400x250	19,5
AR-T/B 80	050151738400	100	0-500° C	150	660x400x250	19,5
AR-T/B 80		150	0-60° C	120	660x400x250	21
AR-T/B 80		150	0-80° C	120	660x400x250	21
AR-T/B 80	050165020000	150	0-120° C	120	660x400x250	21
AR-T/B 80		150	0-160° C	120	660x400x250	21
AR-T/B 80	050165035000	150	0-300° C	120	660x400x250	21
AR-T/B 80		150	0-400° C	120	660x400x250	21
AR-T/B 80	050165038400	150	0-500° C	120	660x400x250	21
AR-T/B 80		200	0-60° C	100	660x400x250	15
AR-T/B 80		200	0-80° C	100	660x400x250	15
AR-T/B 80	050169620000	200	0-120° C	100	660x400x250	15
AR-T/B 80		200	0-160° C	100	660x400x250	15
AR-T/B 80	050169635000	200	0-300° C	100	660x400x250	15
AR-T/B 80		200	0-400° C	100	660x400x250	15
AR-T/B 80	050169638400	200	0-500° C	100	660x400x250	15
AR-T/B 80		300	0-60° C	100	660x400x250	17
AR-T/B 80		300	0-80° C	100	660x400x250	17
AR-T/B 80	050177220000	300	0-120° C	100	660x400x250	17
AR-T/B 80		300	0-160° C	100	660x400x250	17
AR-T/B 80	050177235000	300	0-300° C	100	660x400x250	17
AR-T/B 80		300	0-400° C	100	660x400x250	17
AR-T/B 80	050177238400	300	0-500° C	100	660x400x250	17
AR-T/B 80		400	0-400° C	75	660x400x250	14,5
AR-T/B 80	050179438400	400	0-500° C	75	660x400x250	14,5

On request: different stem length

On request: threaded stem + nut +23% on pricelist

FIG. 569 Ø 100

Zinc plated steel case, back stem.

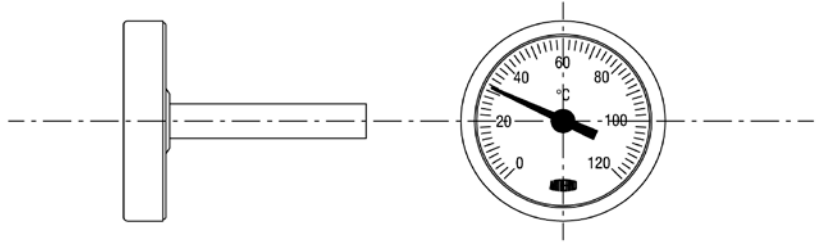

MATERIALS

Case	Zinc plated steel
Window	Clear resin/glass
Dial	Aluminium
Pointer	Resin/aluminium
Stem	Zinc plated steel Ø 9 mm
Temperature element	Bimetallic, spiralled

TECHNICAL SPECIFICATIONS

Design	UNI EN 13190
Temperature limits	Ambient: -20/+60° C Storage: -20/+60° C
Operating temperature	As per scale indication
Accuracy class	2
Degree of protection	IP41 per EN 60 529/IEC 529

Diameter 100 mm

TYPE	CODE	STEM (mm)	TEMPERATURE RANGE	BOX	BOX DIMENSIONS (mm)	WEIGHT (kg)
AR-T/B 100	060127915000	50	0-60° C	100	660x400x250	19
AR-T/B 100		50	0-80° C	100	660x400x250	19
AR-T/B 100	060127919800	50	0-120° C	100	660x400x250	19
AR-T/B 100		50	0-160° C	100	660x400x250	19
AR-T/B 100	060127935500	50	0-300° C	100	660x400x250	19
AR-T/B 100		50	0-400° C	100	660x400x250	19
AR-T/B 100	060127939300	50	0-500° C	100	660x400x250	19
AR-T/B 100	060151715000	100	0-60° C	100	660x400x250	20
AR-T/B 100		100	0-80° C	100	660x400x250	20
AR-T/B 100	060151719800	100	0-120° C	100	660x400x250	20
AR-T/B 100		100	0-160° C	100	660x400x250	20
AR-T/B 100	060151735500	100	0-300° C	100	660x400x250	20
AR-T/B 100		100	0-400° C	100	660x400x250	20
AR-T/B 100	060151739300	100	0-500° C	100	660x400x250	20
AR-T/B 100		150	0-60° C	80	660x400x250	17
AR-T/B 100		150	0-80° C	80	660x400x250	17
AR-T/B 100	060165019800	150	0-120° C	80	660x400x250	17
AR-T/B 100		150	0-160° C	80	660x400x250	17
AR-T/B 100	060165035500	150	0-300° C	80	660x400x250	17
AR-T/B 100		150	0-400° C	80	660x400x250	17
AR-T/B 100	060165039300	150	0-500° C	80	660x400x250	17
AR-T/B 100		200	0-60° C	80	660x400x250	18
AR-T/B 100		200	0-80° C	80	660x400x250	18
AR-T/B 100	060169619800	200	0-120° C	80	660x400x250	18
AR-T/B 100		200	0-160° C	80	660x400x250	18
AR-T/B 100	060169635500	200	0-300° C	80	660x400x250	18
AR-T/B 100		200	0-400° C	80	660x400x250	18
AR-T/B 100	060169639300	200	0-500° C	80	660x400x250	18
AR-T/B 100		300	0-60° C	50	660x400x250	13
AR-T/B 100		300	0-80° C	50	660x400x250	13
AR-T/B 100	060177219800	300	0-120° C	50	660x400x250	13
AR-T/B 100		300	0-160° C	50	660x400x250	13
AR-T/B 100	060177235500	300	0-300° C	50	660x400x250	13
AR-T/B 100		300	0-400° C	50	660x400x250	13
AR-T/B 100	060177239300	300	0-500° C	50	660x400x250	13
AR-T/B 100		400	0-400° C	50	660x400x250	13,50
AR-T/B 100	060179439300	400	0-500° C	50	660x400x250	13,50

On request: different stem length
On request: threaded stem + nut +23% on pricelist

Bimetallic Thermometers with Resin Case

APPLICATIONS: Heating, floor heating, pumping groups in solar systems, boilers.

FIG. 569 Ø 40 Ø 50

Resin without frame/with frame.



TYPE	MODEL	CODE	DIAMETER	STEM (mm)	TEMPERATURE	BOX	BOX DIMENSIONS	WEIGHT (kg)
AR-T/B. RES 40	without frame	023200014800	Ø 40	27	0-60° C	350	600x400x200	6
AR-T/B. RES 40	without frame	023200016100	Ø 40	27	0-80° C	350	600x400x200	6
AR-T/B. RES 40	without frame	023200019800	Ø 40	27	0-120° C	350	600x400x200	6
AR-T/B. RES 40	without frame	023100014800	Ø 40	50	0-60° C	280	600x400x200	5
AR-T/B. RES 40	without frame	023100016100	Ø 40	50	0-80° C	280	600x400x200	5
AR-T/B. RES 40	without frame	023100019800	Ø 40	50	0-120° C	280	600x400x200	5
AR-T/B. RES 50	without frame	033008519800	Ø 50	25	0-120° C	350	600x400x200	6
AR-T/B. RES 50	without frame	033108524000	Ø 50	25	0-160° C	350	600x400x200	6
AR-T/B. RES 50	without frame	033027919800	Ø 50	50	0-120° C	280	600x400x200	5
AR-T/B. RES 50	without frame	033127924000	Ø 50	50	0-160° C	280	600x400x200	5
AR-T/B. RES 40	with frame	022900014800	Ø 40	27	0-60° C	350	600x400x200	6,5
AR-T/B. RES 40	with frame	022900016100	Ø 40	27	0-80° C	350	600x400x200	6,5
AR-T/B. RES 40	with frame	022900019800	Ø 40	27	0-120° C	350	600x400x200	6,5
AR-T/B. RES 40	with frame	023000014800	Ø 40	50	0-60° C	280	600x400x200	5,5
AR-T/B. RES 40	with frame	023000016100	Ø 40	50	0-80° C	280	600x400x200	5,5
AR-T/B. RES 40	with frame	023000019800	Ø 40	50	0-120° C	280	600x400x200	5,5
AR-T/B. RES 50	with frame	032908519800	Ø 50	25	0-120° C	350	600x400x200	6,5
AR-T/B. RES 50	with frame	033208524000	Ø 50	25	0-160° C	350	600x400x200	6,5
AR-T/B. RES 50	with frame	032927919800	Ø 50	50	0-120° C	280	600x400x200	5,5
AR-T/B. RES 50	with frame	033227924000	Ø 50	50	0-160° C	280	600x400x200	5,5

Accessories for Bimetallic Thermometers

POCKET FOR THERMOMETERS



MODEL	CODE	CONNECTION	LENGTH (mm)
BRASS POCKET WITH CLIP SPRING	903733000803	G 3/8 B	30
BRASS POCKET WITH COOP SPRING	903633000801	G 1/2 B	57
COPPER POCKET WITH COOP SPRING	903633000501	G 1/2 B	100
BRASS POCKET WITH SCREW	903633000813V	G 1/2 B	50
BRASS POCKET WITH SCREW	903633000815V	G 1/2 B	100
COPPER POCKET WITH SCREW	003633000541V	G 1/2 B	150
COPPER POCKET WITH SCREW	003633000542V	G 1/2 B	200

CLIPS AND COOPS SPRINGS, GASKETS



MODEL	CODE
COOP SPRING	05034016201
CLIP SPRING	05034205PTZ
GASKET Ø40	17139252048
GASKET Ø50	17139250042
GASKET Ø65	17139250050

Bimetallic Thermometers for Surface Mounting on Pipes



FIXING WITH SPRING

TYPE	CODE	DIAMETER	CASE MATERIAL	TEMPERATURE RANGE	BOX	BOX DIMENSIONS (mm)	WEIGHT (kg)
AR-TUB 63		Ø 63	Zinc plated steel	0-120° C	300	300x500x250	18
AR-TUB. RES 63		Ø 63	Resin	0-120° C	300	300x500x250	10,5

Bimetallic Thermometers for Refrigeration Field

APPLICATIONS: Cooled display windows.



FIG. 540 PIL

Bimetallic table thermometer for cooled display windows.

MODEL	CODE	FASTENER	CASE MATERIAL	BOX	BOX DIMENSIONS (mm)	WEIGHT (kg)
540 PIL	100100040500	Hook or on top	Stainless steel Aisi 430	250	650x380x240	7



FIG. 569 A

Bimetallic industrial thermometer suitable for reading the temperature of cooled display windows.

MODEL	CODE	FASTENER	CASE MATERIAL	BOX	BOX DIMENSIONS (mm)	WEIGHT (kg)
569 A	030500053000	Thread screw 3/8" and nut	Stainless steel Aisi 304	150	500x300x260	10



FIG. 519 B

Bimetallic hook thermometer for cooled display windows.

MODEL	CODE	FASTENER	CASE MATERIAL	BOX	BOX DIMENSIONS (mm)	WEIGHT (kg)
519 B	812600040200	With hook	White plastic	500	650x380x240	10

Thermometer for Freezers

DESCRIPTION: Rectangular thermometer for freezers. Temperature range -40° +40° C. Available Fahrenheit version.



ARTHERMO FREEZER

MODEL	CODE	BOX	BOX DIMENSIONS (mm)	WEIGHT (kg)
ARTHERMO FREEZER*	701200040000	500	375X360X360	15

* Products normally available at stock



ARThERMO



Thermostats

Section 4

Boxed Thermostats "Arthermostat Line"

NEW

APPLICATIONS: Suitable for automatic adjustment of appliances in cooling and heating field.

ARTH093 - ARTH096 - ARTH097

Boxed adjustable thermostats, single pole, liquid filled sensing bulbs, SPDT contacts.



CODE	CAPILLARY	TEMPERATURE RANGE	BOX	BOX DIMENSIONS (mm)	WEIGHT (kg)
ARTH093*	1500 mm	-35/+35° C	96	600x400x270	18
ARTH096*	1500 mm	0/40° C	96	600x400x270	18
ARTH097*	1500 mm	0/90° C	96	600x400x270	18

TECHNICAL SPECIFICATIONS

Switching capacity	ARTH093: C-1 2,5(0,6)A 400 VAC / C-2 15(3)A 400VAC ARTH096 - ARTH097: C-1 15(3)A 400 VAC / C-2 2,5(06)A 400VAC
Life of product	100000 switching cycles
Minimum current	200 mA without gold contact
Insulation resistant	> 100 Mohm
Max temp. around body	T 110° C
Max temp. around bulb	+15% switching value
Dielectric strenght	AC 2000 V 1 min
Connection	Faston 6,3x0,8
European approvals	Thermostat inside ENEC 03
Degree of protection	IP40

ARTH094 - ARTH095

Boxed adjustable thermostats, single pole, liquid filled sensing bulbs, SPDT contacts.



CODE	CAPILLARY	TEMPERATURE RANGE	BOX	BOX DIMENSIONS (mm)	WEIGHT (kg)
ARTH094*	-	-35/+35° C	50	600x400x170	9
ARTH095*	-	0/40° C	50	600x400x170	9

TECHNICAL SPECIFICATIONS

Switching capacity	C-1 15(3)A 400 VAC / C-2 2,5(06)A 400VAC
Life of product	100000 switching cycles
Minimum current	200 mA without gold contact
Insulation resistant	> 100 Mohm
Max temp. around body	T 110° C
Max temp. around bulb	+15% switching value
Dielectric strenght	AC 2000 V 1 min
Connection	Faston 6,3x0,8
European approvals	Thermostat inside ENEC 03
Degree of protection	IP40

ARTH090

Boxed room temperature control , liquid filled operating, SPDT contacts.



CODE	CAPILLARY	TEMPERATURE RANGE	BOX	BOX DIMENSIONS (mm)	WEIGHT (kg)
ARTH090*	spiral	0/40° C	50	600x400x170	10

TECHNICAL SPECIFICATIONS

Switching capacity	C-1 15(3)A 400 VAC / C-2 2,5(0,6)A 400 VAC
Life of product	100000 switching cycles
Minimum current	200 mA without gold contact
Insulation resistant	> 100 Mohm
Max temp. Around body	T 110° C
Max temp. Around bulb	+15% switching value
Dielectric strenght	AC 2000 V 1 min
Connection	Faston 6,3x0,8
European approvals	Thermostat inside ENEC 03
Degree of protection	IP40

* Products normally available at stock

Boxed Thermostats "Arthermostat Line"

NEW

APPLICATIONS: Suitable for automatic adjustment of heating systems, burners and pumps.

ARTH100

Immersion thermostat liquid filled operating, SPDT contacts, with waterproof protection pocket.



TECHNICAL SPECIFICATIONS

Switching capacity	C-1 15(3)A 400 VAC / C-2 2,5(0,6)A 400VAC
Life of product	100000 switching cycles
Minimum current	200 mA without gold contact
Insulation resistant	> 100 Mohm
Max temp. around body	T 110° C
Max temp. around bulb	+15% switching value
Dielectric strenght	AC 2000 V 1 min
Connection	Faston 6,3x0,8
European approvals	Thermostat inside ENEC 03
Degree of protection	IP40

CODE	POCKET LENGTH (mm)	TEMPERATURE RANGE	BOX	BOX DIMENSIONS (mm)	WEIGHT (kg)
ARTH100*	100	0/90° C	42	600x400x170	10

ARTH300

Boxed thermostats for pipes direct contact, liquid filled sensing bulb, single pole, SPDT contacts. Easy installation through heat resistant band tie.



TECHNICAL SPECIFICATIONS

Switching capacity	C-1 15(3)A 400 VAC / C-2 2,5(0,6)A 400VAC
Life of product	100000 switching cycles
Insulation resistant	> 100 Mohm
Max temp. around body	T 110° C
Degree of protection	IP40

CODE	CAPILLARY	TEMPERATURE RANGE	BOX	BOX DIMENSIONS (mm)	WEIGHT (kg)
ARTH300*	-	0/90° C	50	600x400x170	9,5

ARTH201—ARTH202

Boxed safety manual reset thermostats for pipe direct contact through heat-resistant band tie (ARTH201) and for immersion with a 1/2" x 100mm waterproof protection pocket (ARTH202). Liquid filled operating, SPDT contacts.



TECHNICAL SPECIFICATIONS

Switching capacity	C-1 1A 250VAC / C-2 16A 250VAC
Life of product	6000 switching cycles
Minimum current	200 mA
Insulation resistant	> 100 Mohm
Max temp. Around body	T 150°C
Max temp. Around bulb	T 130°C
Dielectric strenght	AC 2000 V 1 min
Connection	Faston 6,3x0,8
European approvals	Thermostat inside VDE
Degree of protection	IP40

CODE	CAPILLARY	SAFETY TEMPERATURE	BOX	BOX DIMENSIONS (mm)	WEIGHT (kg)
ARTH201*	-	100° C ± 5°C	50	600x400x170	9,5
CODE	POCKET LENGTH (mm100)	SAFETY TEMPERATURE	BOX	BOX DIMENSIONS (mm)	WEIGHT (kg)
ARTH202*	100	100° C ± 5°C	42	600x400x170	10

* Products normally available at stock

Boxed Thermostats "Arthermostat Line"

NEW

APPLICATIONS: Suitable for automatic adjustment of heating systems, burners and pumps.

ARTH400

Double boxed thermostat adjustable and safety manual reset thermostat, liquid filled operating, SPDT contacts, with waterproof protection pocket.



TECHNICAL SPECIFICATIONS Adjustable Thermostat

Switching capacity	C-1 15(3)A 400 VAC / C-2 2,5(0,6)A 400 VAC
Life of product	100000 switching cycles
Minimum current	200 mA without gold contact
Insulation resistant	> 100 Mohm
Max temp. Around body	T 110° C
Max temp. Around bulb	+15% switching value
Dielectric strenght	AC 2000 V 1 min
Connection	Faston 6,3x0,8
European approvals	Thermostat inside ENEC 03
Degree of protection	IP40

TECHNICAL SPECIFICATIONS Safety Thermostat

Switching capacity	C-1 1A 250VAC / C-2 16A 250VAC
Life of product	6000 switching cycles
Minimum current	200 mA
Insulation resistant	> 100 Mohm
Max temp. Around body	T 150° C
Max temp. Around bulb	T 130° C
Dielectric strenght	AC 2000 V 1 min
Connection	Faston 6,3x0,8
European approvals	Thermostat inside VDE
Degree of protection	IP40

CODE	POCKET LENGTH MM	RANGE TEMPERATURE	SAFETY TEMPERATURE	BOX	BOX DIMENSIONS (mm)	WEIGHT (kg)
ARTH400*	100	0 / 90°C	100° C ± 5°C	24	600x400x170	11

ARTH401

Double boxed adjustable thermostat, liquid filled operating, SPDT contacts, with waterproof protection pocket.



TECHNICAL SPECIFICATIONS Adjustable Thermostat N.1 and N.2

Switching capacity	C-1 15(3)A 400 VAC / C-2 2,5(0,6)A 400 VAC
Life of product	100000 switching cycles
Minimum current	200 mA without gold contact
Insulation resistant	> 100 Mohm
Max temp. Around body	T 110° C
Max temp. Around bulb	+15% switching value
Dielectric strenght	AC 2000 V 1 min
Connection	Faston 6,3x0,8
European approvals	Thermostat inside ENEC 03
Degree of protection	IP40

CODE	POCKET LENGTH MM	RANGE TEMPERATURE	SAFETY TEMPERATURE	BOX	BOX DIMENSIONS (mm)	WEIGHT (kg)
ARTH401*	100	0 / 90°C	0 / 90°C	24	600x400x170	11

* Products normally available at stock

Classic Boxed Thermostats "TSC Line"

APPLICATIONS: Suitable for automatic adjustment of appliances in cooling field.

TSC-093C - TSC-096C - TSC-097C

Encased adjustable thermostats, single pole, liquid filled sensing bulbs, SPDT contacts.



TECHNICAL SPECIFICATIONS

Switching capacity	TSC-096C - TSC-097C: C-1 15(3)A 400 VAC / C-2 2,5(0,6)A 400VAC TSC-093C: C-1 2,5(0,6)A 400 VAC / C-2 15(3)A 400VAC
Life of product	100000 switching cycles
Minimum current	200 mA without gold contact
Insulation resistant	> 100 Mohm
Max temp. around body	T 110° C
Max temp. around bulb	+15% switching value
Dielectric strenght	AC 2000 V 1 min
Connection	Faston 6,3x0,8
European approvals	Thermostat inside ENEC 03
Degree of protection	IP44

CODE	CAPILLARY	TEMPERATURE RANGE	BOX	BOX DIMENSIONS (mm)	WEIGHT (kg)
TSC-093C	1500 mm	-35/+35 ° C	96	660x400x250	18
TSC-096C	1500 mm	0/40 ° C	96	660x400x250	18
TSC-097C	1500 mm	0/90 ° C	96	660x400x250	18

TSC-094C - TSC-095C

Encased adjustable thermostats, single pole, liquid filled sensing bulbs, SPDT contacts.



TECHNICAL SPECIFICATIONS

Switching capacity	C-1 15(3)A 400 VAC / C-2 2,5(0,6)A 400VAC
Life of product	100000 switching cycles
Minimum current	200 mA without gold contact
Insulation resistant	> 100 Mohm
Max temp. around body	T 110° C
Max temp. around bulb	+15% switching value
Dielectric strenght	AC 2000 V 1 min
Connection	Faston 6,3x0,8
European approvals	Thermostat inside ENEC 03
Degree of protection	IP44

CODE	CAPILLARY	TEMPERATURE RANGE	BOX	BOX DIMENSIONS (mm)	WEIGHT (kg)
TSC-094C	-	-35/+35 ° C	50	660x400x250	9
TSC-095C	-	0/40 ° C	50	660x400x250	9

Capillary Thermostats

APPLICATIONS: Automatic adjustment in refrigeration equipments and cold appliances.



Accessories Included



TECHNICAL SPECIFICATIONS

Switching capacity	C-1 15(3)A 400 VAC / C-2 2,5(0,6)A 400VAC
Life of product	100000 switching cycles
Minimum current	200 mA without gold contact
Insulation resistant	> 100 Mohm
Max temp. around body	T 110° C
Max temp. around bulb	+15% switching value
Dielectric strenght	AC 2000 V 1 min
Connection	Faston 6,3x0,8
European approvals	Thermostat inside ENEC 03

CODE	CAPILLARY	TEMPERATURE RANGE	BOX	BOX DIMENSIONS (mm)	WEIGHT (kg)
C705503001B*	1500 mm	-35+35°C	100	420x370x200	12
C702512311N*	1500 mm copper	0/40°C	100	420x370x200	12
C700502112N*	1500 mm copper	0/90°C	100	420x370x200	12
C702003235N*	1500 mm copper	30/120°C	100	420x370x200	12
C704253470N*	1500 mm stainless steel	0/220°C	100	420x370x200	12
C713202530N*	1500 mm stainless steel	50/315°C	100	420x370x200	12

* Products normally available at stock

ARTHERMO



Digital Instruments

Section 5

Digital Instruments

CHARACTERISTICS: Digital thermometers with high accuracy for the refrigeration and heating fields.

DIGITAL CONTROLLERS

Packaging: 1 box = N° 80 pcs, size 650x380x240 mm, weight 23 kg.



TECHNICAL SPECIFICATIONS

Panel size	75x34,5 mm
Installing size	71x29 mm
Product size	75x34,5x85 mm
Power supply	220 VAC ± 10%, 50/60 Hz
Power consumption	<5W
Accuracy	± 1° C

MODEL	MEASURING/REGULATION	REG. OUTPUT	DEFROSTING CYCLE	DEFROSTING Time	INPUT
CO3	-50/+120°C	1SPDT, 16A/240VAC			SONDA NTC 2000 mm
CO3D	-50/+120°C	1SPDT,16A/240VAC;1SPDT 10A	0/99 ORE (REG)	0/99 MIN (REG)	SONDA NTC 2000 mm
CO3D2	-50/+99°C	2SPDT 10A/240VAC	0/99 ORE (REG)	0/99 MIN (REG)	2 SOND E NTC 2000 mm
CO3DFA	-45/+50°C	3 E UN SCR	0/99 ORE (REG)	0/99 MIN (REG)	3 SOND E NTC 2000 mm
CO3H	-40/+150°C	10A/250VAC			SONDA PTC 2000 mm
NDC200	-45/+99°C	30ASPDT (COMPR); 3ASPST (ALLARME)	0/999 ORE (REG)		SONDA NTC

DIGITAL THERMOMETER ROF-DIG*

Packaging: 1 box = N° 100 pcs, size 320x260x270 mm, weight 8 kg.



TECHNICAL SPECIFICATIONS

Panel size	64x31 mm
Installing size	58,4x25,7 mm
Temperature range	-30/+110° C
Ambient temperature	-10/+60° C
Relative humidity	20% +85%
Power supply	230 VAC ±10% 50-60Hz
Power consumption	Max 3 W
Resolution	0,1° C (<100° C) 1° C (>100° C)
Probe	NTC mm 2000

DIGITAL THERMOMETER 24W*

Packaging: 1 box = N° 80 pcs, size 320x260x270 mm, weight 7 kg, back battery.



TECHNICAL SPECIFICATIONS

Case material	White plastic
Fastener	Clips
Temperature range	-40/+70° C
Feed	Lithium battery
Battery duration	About 1 year
Probe	NTC mm 3000

On request: front battery

On request: adapter

* Products normally available at stock

DIGITAL THERMOMETER SOLARCELLAR SD-5

Packaging: 1 box = N° 100 pcs, size 320x260x270 mm, weight 7 kg.



TECHNICAL SPECIFICATIONS

Temperature range	-50/+99° C
Sampling time	10 seconds
Sensor cable	1500 mm
Power	Solar panel
Environment	A): illumination level >60 lux, humidity 5-85% B): illumination level >40 lux, humidity 5-85%

DIGITAL THERMOMETER PT-1

Packaging: 1 box = N° 100 pcs, size 650x380x240 mm, weight 6 kg.



TECHNICAL SPECIFICATIONS

Temperature range	-50/+300° C; -58/572° F
Resolution	0,1° C (-19,9/+199,9° C)
Probe dimension	125 mm

DIGITAL THERMOMETER PT-2

Packaging: 1 box = N° 100 pcs, size 650x380x240 mm, weight 6 kg.



TECHNICAL SPECIFICATIONS

Temperature range	-50/+300° C; -58/572° F
Resolution	0,1° C (-19,9/+199,9° C)
Dimension	59x107x19 mm

DIGITAL THERMOMETER PT-6

Packaging: 1 box = N° 100 pcs, size 320x260x270 mm, weight 7 kg.



TECHNICAL SPECIFICATIONS

Case material	Blue or black plastic
Temperature range	-50/+300° C; -58/572° F
Accuracy	± 1° C (2° F) between -20° C +80° C
Function	Memory, hold, °C/°F
Battery power	DC 1,5V (alkaline battery)
Probe size	Stainless steel 125 mm Ø 4 mm

DIGITAL THERMOMETER TPM-20

Packaging: 1 box = N° 100 pcs, size 320x260x270 mm, weight 7 kg.



TECHNICAL SPECIFICATIONS

Temperature range	-50/+70° C
Resolution	± 1° C (> -20° C) 1° C (< -20° C)
Accuracy	± 1° C
Power	DC 1,5V AAA batteries
Product size	72x32x28 mm
Installing size	52x25 mm

DIGITAL CONTROL PANEL FD-B

Packaging: 1 box = N° 100 pcs, size 650x380x240 mm, weight 6 kg.

**TECHNICAL SPECIFICATIONS**

Temperature range	-50/+99° C
Resolution	1° C
Power supply	230 VAC 50/60 Hz
Dimension	170x60x40 mm
Probe	NTC 1500 mm

TEMPERATURE RECORDER DR-400**TECHNICAL SPECIFICATIONS**

Temperature range	NTC -40/+120° C PT1000 -200/+650° C
Display	LCD, two line backlist adjustable
Power	12÷24 VDC or 85÷265 VAC (optional)
Accuracy	NTC $\pm 0,5^{\circ}$ C PT 1000 $\pm 0,3^{\circ}$ C
Memory capacity	Max 13000 points IP65 Waterproof

New Products Coming Soon

ARTHERMO

Heating and Sanitary

Section 6

Manometers

CHARACTERISTICS: Manometers with resin case, radial or back attachment, suitable in the thermosanitary sector.

MANOMETER



TECHNICAL SPECIFICATIONS

Case	ABS
Window	Plastic with red pointer
Attachment	Radial or back in brass
Accuracy class	1,6
Degree of protection	IP 31
Weldings	Tin alloy for temperatures from -20 to +90° C
Movement	In brass
Dial	White with black writing "ARTHERMO" branded

CODE	DIAMETER (mm)	ATTACHMENT	PRESSURE RANGE	BOX	BOX DIMENSIONS (mm)	WEIGHT (kg)
MA500/P	50	G1/4" RADIAL	0/4 BAR	120	490X240X210	9
MA501/P	50	G1/4" RADIAL	0/6 BAR	120	490X240X210	9
MA502/P	50	G1/4" RADIAL	0/10 BAR	120	490X240X210	9
MA503/P	50	G1/4" RADIAL	0/16 BAR	120	490X240X210	9
MA504/P	50	G1/4" RADIAL	0/25 BAR	120	490X240X210	9
MA550/P	50	G1/4" BACK	0/4 BAR	125	490X240X210	11
MA551/P	50	G1/4" BACK	0/6 BAR	125	490X240X210	11
MA552/P	50	G1/4" BACK	0/10 BAR	125	490X240X210	11
MA553/P	50	G1/4" BACK	0/16 BAR	125	490X240X210	11
MA554/P	50	G1/4" BACK	0/25 BAR	125	490X240X210	11
MA001/P	63	G1/4" RADIAL	0/4 BAR	100	490X240X210	9,5
MA002/P	63	G1/4" RADIAL	0/6 BAR	100	490X240X210	9,5
MA003/P	63	G1/4" RADIAL	0/10 BAR	100	490X240X210	9,5
MA004/P	63	G1/4" RADIAL	0/16 BAR	100	490X240X210	9,5
MA005/P	63	G1/4" RADIAL	0/25 BAR	100	490X240X210	9,5
MA200/P	63	G1/4" BACK	0/4 BAR	80	490X240X210	9,5
MA201/P	63	G1/4" BACK	0/6 BAR	80	490X240X210	9,5
MA202/P	63	G1/4" BACK	0/10 BAR	80	490X240X210	9,5
MA203/P	63	G1/4" BACK	0/16 BAR	80	490X240X210	9,5
MA204/P	63	G1/4" BACK	0/25 BAR	80	490X240X210	9,5
MA050/P	80	G3/8" RADIAL	0/4 BAR	50	490X240X210	9,5
MA051/P	80	G3/8" RADIAL	0/6 BAR	50	490X240X210	9,5
MA052/P	80	G3/8" RADIAL	0/10 BAR	50	490X240X210	9,5
MA053/P	80	G3/8" RADIAL	0/16 BAR	50	490X240X210	9,5
MA054/P	80	G3/8" RADIAL	0/25 BAR	50	490X240X210	9,5
MA100/P	100	G1/2" RADIAL	0/4 BAR	30	490X240X210	8,5
MA101/P	100	G1/2" RADIAL	0/6 BAR	30	490X240X210	8,5
MA102/P	100	G1/2" RADIAL	0/10 BAR	30	490X240X210	8,5
MA103/P	100	G1/2" RADIAL	0/16 BAR	30	490X240X210	8,5
MA104/P	100	G1/2" RADIAL	0/25 BAR	30	490X240X210	8,5

Thermometers with Pocket

APPLICATIONS: Heating, floor heating, boilers and electrical appliances.

TECHNICAL SPECIFICATIONS

Design	UNI EN 13190
Temperature limits	Ambient: -20/+60° C - Storage: -20/+60° C
Accuracy class	2
Degree of protection	IP41 per EN 60 529/IEC 529

FIG. 596

Bimetallic, zinc plated steel case, back stem. 1/2" pocket included.

FIG. 536

Radial thermometer with zinc plated steel or resin case. 1/2" pocket included. Working through liquid expansion.



MATERIALS (FIG. 569)

Case	Zinc plated steel
Window	Clear resin/glass
Dial	Aluminium
Pointer	Resin/aluminium
Stem	Zinc plated steel Ø 9 mm
Temperature element	Bimetallic spiral
Pocket	Brass, screw included

MATERIALS (FIG. 536)

Case	Black zinc plated steel or resin
Window	Clear resin/glass
Dial	Aluminium
Pointer	Aluminium
Stem	Brass Ø 6 mm
Temperature element	Liquid expansion
Pocket	Brass

TYPE	CODE	STEM (mm)	TEMPERATURE RANGE	BOX	BOX DIMENSIONS (mm)	WEIGHT (kg)
AR-T/B 50	03012791990G	50	0-120° C	120	600x400x200	10,8
AR-T/B 50	03015171990G	100	0-120° C	70	600x400x200	7,5
AR-T/B 65	04012791990G	50	0-120° C	120	600x400x200	10,8
AR-T/B 65	04015171990G	100	0-120° C	70	600x400x200	7,5
AR-T/B 80	05012792000G	50	0-120° C	120	600x400x200	15,2
AR-T/B 80	05015172000G	100	0-120° C	50	600x400x200	9
AR-T/B 100	06012791980G	50	0-120° C	60	600x400x200	12
AR-T/B 100	06015171980G	100	0-120° C	30	600x400x200	7,5
AR-T/RAD 60	110127519502G	50	0-120° C	40	600x400x200	9
AR-T/RAD 60	110151019502G	100	0-120° C	40	600x400x200	9,5
AR-T/RAD 80	113727519502G	50	0-120° C	20	600x400x200	7,5
AR-T/RAD 80	113751019502G	100	0-120° C	20	600x400x200	8
AR-T/RAD 100	116427519502G	50	0-120° C	20	600x400x200	8,5
AR-T/RAD 100	116451019502G	100	0-120° C	20	600x400x200	9,5
AR-T/RAD.RES 60	111026119502	50	0-120° C	40	600x400x200	8
AR-T/RAD.RES 60	111049519502	100	0-120° C	40	600x400x200	8,5
AR-T/RAD.RES 80	114026119502	50	0-120° C	20	600x400x200	6,5
AR-T/RAD.RES 80	114049519502	100	0-120° C	20	600x400x200	7
AR-T/RAD.RES 100	116026119502	50	0-120° C	20	600x400x200	7,5
AR-T/RAD.RES 100	116049519502	100	0-120° C	20	600x400x200	8,5

Heating Elements

CHARACTERISTICS RT

Heating element in Ø8 CU tube
 1"1/4 gas brass cap
 Sealing with epoxy resins
 Repressed bend for a more homogeneous magnesium oxide density
 Standard: 230V



RT SERIES

CODE RT	POWER	L1	L2
RT011A	1200 W	300mm	280 mm
RT012A	1500 W	300mm	280 mm
RT013A-400	2000 W	400mm	280 mm



RT - BENT SERIES

CODE RT	POWER	L1	L2	L3
RT140A	1200 W	280 mm	170 mm	135 mm
RT145A	1500 W	280 mm	170 mm	135 mm
RT150A-400	2000 W	280 mm	220 mm	180 mm

CHARACTERISTICS RF

Heating element in Ø8 CU tube
 Ø 48 brass flange
 Sealing with epoxy resins
 Repressed bend for a more homogeneous magnesium oxide density
 Standard: 230V

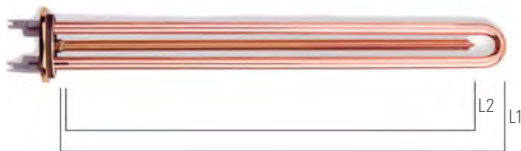

RF SERIES

CODE RF	POWER	L1	L2
RF011A	1200 W	300 mm	280 mm
RF012A	1500 W	300 mm	280 mm
RF013A	2000 W	400 mm	280 mm
RF014A high faston	1200 W	300 mm	280 mm

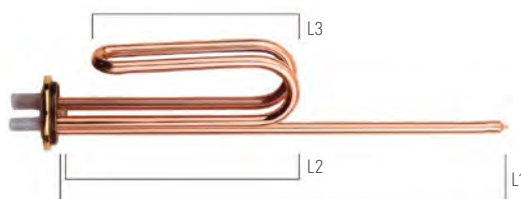

RF - BENT SERIES

CODE RF	POWER	L1	L2	L3
RF111A	1200 W	280 mm	175 mm	135 mm
RF112A	1500 W	280 mm	175 mm	135 mm
RF113A-400	2000 W	280 mm	215 mm	185 mm
RF116A high faston	1200 W	280 mm	175 mm	135 mm

Special versions of heating elements are available on request.
 Minimum quantity: 1000 Pcs.

Adjustable Thermostats

TS 030



CHARACTERISTICS

Temperature range	20 - 80° C
Electric rating	20A - 250V
Sensing element	Rigid stem
Standard stem	275 mm

TS 150

With bipolar safety.



CHARACTERISTICS

Temperature range	20 - 80° C
Bipolar safety calibration	90° C
Electric rating	20A - 250V
Sensing element	Rigid stem
Standard stem	275 mm

Resistor Gaskets

GF 100	RF gasket
GT 002	O ring

Neon Signals



LA 200

Safety Valves

STANDARD REGULATION: 8 bar (other regulations on request).



VA 090

1/2" MF.



VA 130

1/2" MF with lever.

Thermometers

CHARACTERISTICS: Bimetallic industrial thermometer, designed for reading the temperature of electric boilers.

FIG. 599



599.1 blue



599.1 red

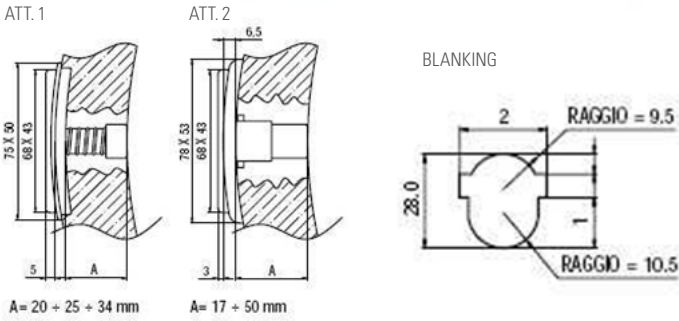

FIG. 600



600.1 blue



600.4 grey



600.2 red



600.5 white

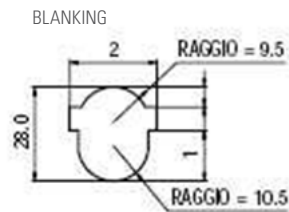
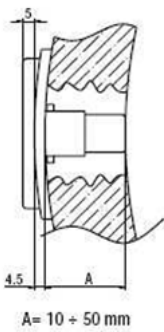

600.3 black



On request: customized dial minimum quantity: 5000 Pcs.

ARTHERMO

ARTHERMO Srl
Via Italia 32
20060 Gessate (Mi) Italy
Tel. +39 02 95781144
Fax +39 02 95382362
info@arthermo.com
www.arthermo.com

The data and the characteristics indicated in this catalogue are not binding.
Arthermo reserves the right to make changes in above specifications without obligation of notice.