



FEATURES:

- Super wide 6:1 Input range
- Extremely High Input range up to 1500VDC
- High I/O Isolation of 4000VDC and 4000VAC
- Over current and Over Voltage protection
- No minimum load required
- High efficiency of up to 84%
- Under Voltage Input protection
- Reversed connection protection



Models
Single output

Model	Input Voltage (V)	Output Voltage (V)	Output Current max (A)	Isolation (VDC)	Max Capacitive Load(uF)	Efficiency (200VDC) (%)
AM40W-60012S-NZ ‡	200-1200	12	3.33	4000	1200	83
AM40W-60015S-NZ ‡	200-1200	15	2.67	4000	1000	84
AM40W-60024S-NZ ‡	200-1200	24	1.67	4000	680	84
AM40W-80012S-NZ ‡‡	200-1500	12	3.33	4000*	3000	76**
AM40W-80015S-NZ ‡‡	200-1500	15	2.67	4000*	1500	78**
AM40W-80024S-NZ ‡‡	200-1500	24	1.67	4000*	680	80**

* VAC I/O Isolation

** Measured at 800VDC nominal input.

‡ For 600VDC input models add suffix “-ST” for optional screw terminal bottom plate or “-STD” for optional DIN Rail screw terminal bottom plate.

‡‡ For 800VDC input models add suffix “-ST” for optional DIN Rail screw terminal bottom plate with fuse or “-STF” for optional DIN Rail screw terminal bottom plate with no fuse.

NOTE: All specifications in this datasheet are measured at an ambient temperature of 25°C, humidity<75%, nominal input voltage and at rated output load unless otherwise specified.

Input Specifications

Parameters	Conditions	Typical	Maximum	Units
Voltage range	600VDC		200-1200	VDC
	800VDC		200-1500	
Input Current	600VDC input models - 200VDC		320	mA
	600VDC input models - 600VDC		100	
	600VDC input models - 1200VDC		55	
	800VDC input models - 200VDC		320	
	800VDC input models 800VDC		80	
	800VDC input models 1500VDC		42	
Inrush current <2ms	600VDC input models 600VDC	60		
	800VDC input models - 200VDC	30		
	800VDC input models 800VDC	80		
	800VDC input models 1500VDC	150		
External fuse	600VDC input models, Slow blow	3.15		A
	800VDC input models, Slow blow		15A/1500VDC	
Input Under voltage lockout	600VDC input models only	175-185		VDC
Input under voltage protection	800VDC input models only, ON		170-185	VDC
	800VDC input models only, OFF		180-195	
Startup time	800VDC		2	s

Isolation Specifications

Parameters	Conditions	Typical	Maximum	Units
Tested I/O voltage 600VDC input models	1 min	4000		VDC
Tested I/O voltage 800VDC input models	1 min	4000		VAC

Output Specifications

Parameters	Conditions	Typical	Maximum	Units
Voltage accuracy		±2		%
Line voltage regulation	LL-HL	±1		% of Vin
Load voltage regulation	0-100% load	±1		%
Over voltage protection	Zener diode clamp			
Over current protection	600VDC input models		110	% of Iout
	800VDC input models		120-320	
Short Circuit protection	Continuous			
Short circuit restart	Auto recovery			
Temperature coefficient		±0.02		%/°C
Ripple & Noise	20MHz Bandwidth, 600VDC input models	100	200	mV p-p
	20MHz Bandwidth, 800VDC input models	150	300	
Hold up time	600VDC	5		ms

General Specifications

Parameters	Conditions	Typical	Maximum	Units
Switching frequency	100% load	65		KHz
Operating temperature	600VDC input models, derating above 50°C		-25 to 70	°C
	800VDC input models, see derating curve		-40 to 70	
Storage temperature	600VDC input models		-25 to 85	°C
	800VDC input models		-40 to 85	
Maximum case temperature			95	°C
Cooling	Natural convection			
Humidity			95	% RH
Case material	Black plastic (UL94-V0)			
Weight	600VDC input models		210 With optional -ST mounting plate: 295 With optional -STD mounting plate: 365	g
	800VDC input models		410 With optional -ST mounting plate: 610	
Dimensions (L x W x H)	600VDC input models With optional -ST mounting plate: With optional -STD mounting plate:		3.50 x 2.50 x 0.98 inches, 89.00 x 63.50 x 25.00mm 5.31 x 2.95 x 1.32 inches, 135.00 x 75.00 x 33.50 mm 5.31 x 2.95 x 1.54 inches, 135.00 x 75.00 x 39.00 mm	
	800VDC input models With optional -ST mounting plate:		4.92 x 2.95 x 1.58 inches, 125.00 x 75.00 x 40.00mm 5.75 x 5.43 x 2.17 inches, 146.00 x 138.00 x 55.00mm	
MTBF	>300,000 hrs (MIL-HDBK -217F, Ground Benign, t=+25°C)			
Maximum soldering temperature	1.5mm from case for 5-10 sec		260	°C

Safety Specifications

Parameters		
Approvals	CSA, CE	
	CSA-C22.2 No.107.1-01, UL 1741, EN62109	
Standards	EMI - Conducted and radiated emission	EN55022, class A (with the recommended EMC circuit) EN55024: 2010
	Electrostatic Discharge Immunity	IEC 61000-4-2: Contact ±6KV/Air ±8KV, Criteria B
	RF, Electromagnetic Field Immunity	IEC 61000-4-3: 10V/m, Criteria A
	Electrical Fast Transient/Burst Immunity (600VDC Vin)	IEC 61000-4-4: ±4KV, Criteria B
	Electrical Fast Transient/Burst Immunity (800VDC Vin)	IEC 61000-4-4: ±2KV, Criteria B (with the recommended EMC circuit)
	Surge Immunity (600VDC Vin)	IEC 61000-4-5: ±2KV, Criteria B
	Surge Immunity (800VDC Vin)	IEC 61000-4-5: ±1KV, Criteria B (with the recommended EMC circuit)
	RF, Conducted Disturbance Immunity	IEC 61000-4-6: 10Vrms, Criteria A
	Power frequency Magnetic Field Immunity	IEC 61000-4-8: 10A/m, Criteria A
	Voltage dips, Short Interruptions Immunity	IEC 61000-4-11: 0-70%, Criteria B

Pin Out Specifications

Pin	600VDC Input
1	+Vin
2	-Vin
3	+Vout
4	-Vout
5	N.C.

**Dimensions
600VDC Input models**

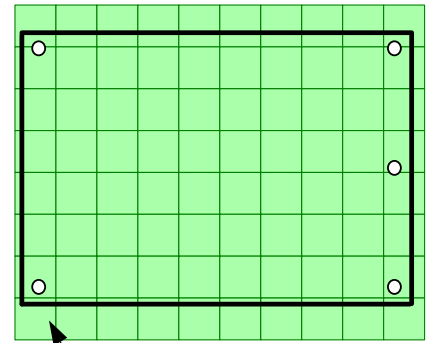
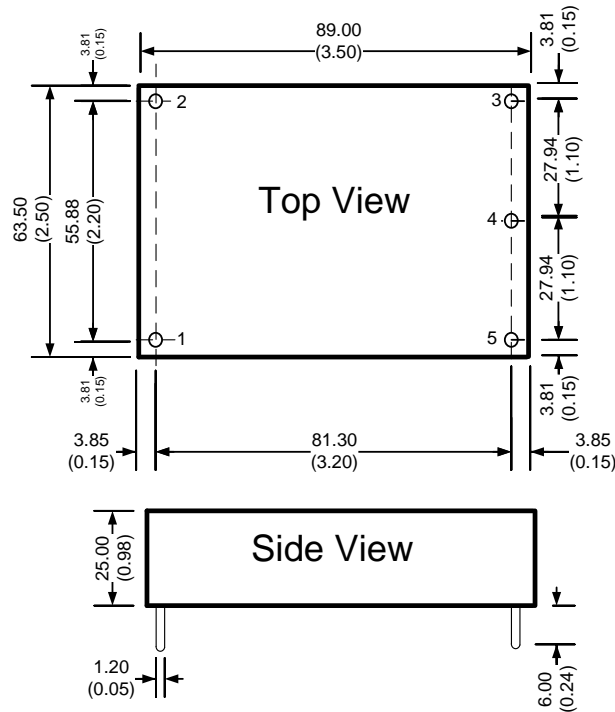

DIV: 10.00 (0.40)

Dimensions mm (inch)
Case Tolerance ± 0.50 (± 0.02)
Pin Diameter ± 0.10 (± 0.004)

600VDC input models with optional -ST bottom plate

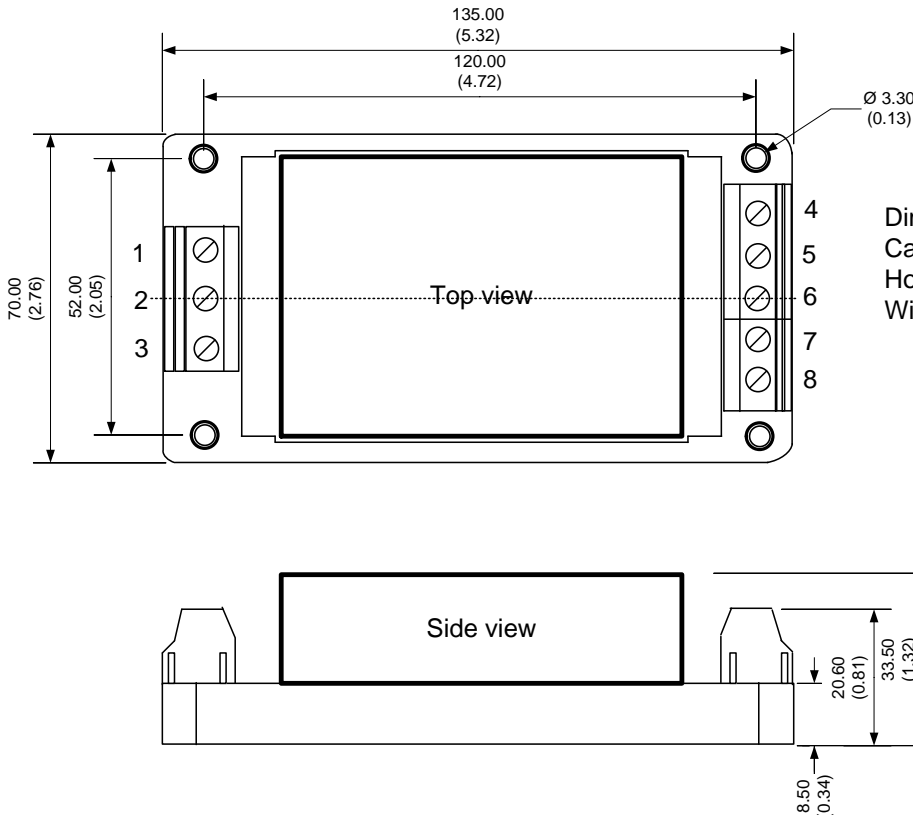

Dimensions: mm (inch)
Case Tolerance: ± 1.00 (0.04)
Holding holes tolerance: ± 0.20 (0.01)
Wire gauge: 24-12AWG

Pin Out Specifications

Pin	Single
1	-Vin
2	N.C.
3	+Vin
4	+Vout
5	N.C.
6	-Vout
7	N.C.
8	N.C.

600VDC input models with optional -STD bottom plate

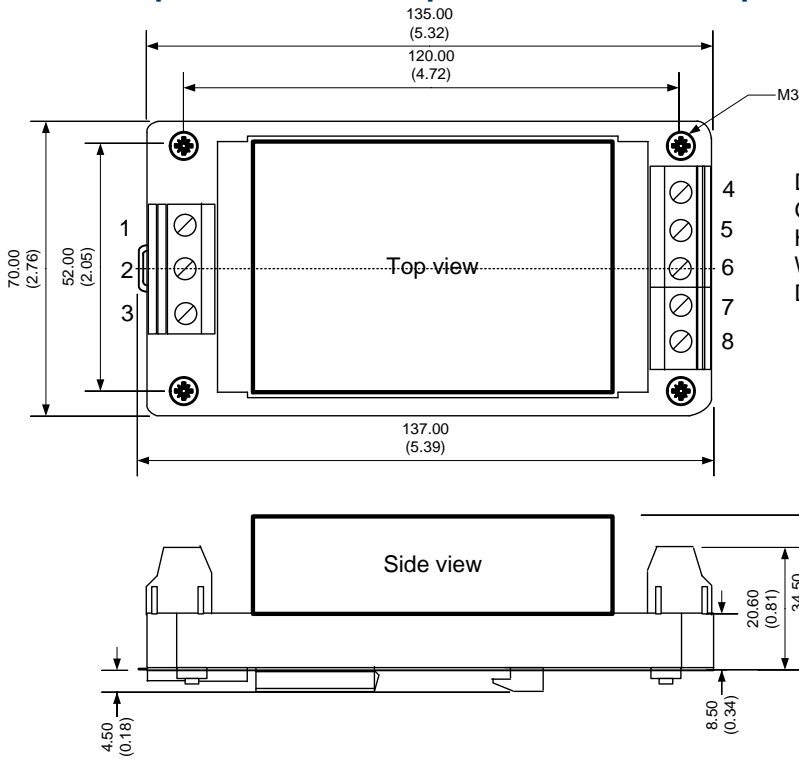

Dimensions: mm (inch)
 General Tolerance: ± 1.00 (0.04)
 Holding holes tolerance: ± 0.20 (0.01)
 Wire gauge: 24-12AWG
 DIN rail type: TS35

Pin Out Specifications

Pin	Single
1	-Vin
2	N.C.
3	+Vin
4	+Vout
5	N.C.
6	-Vout
7	N.C.
8	N.C.

800VDC input models

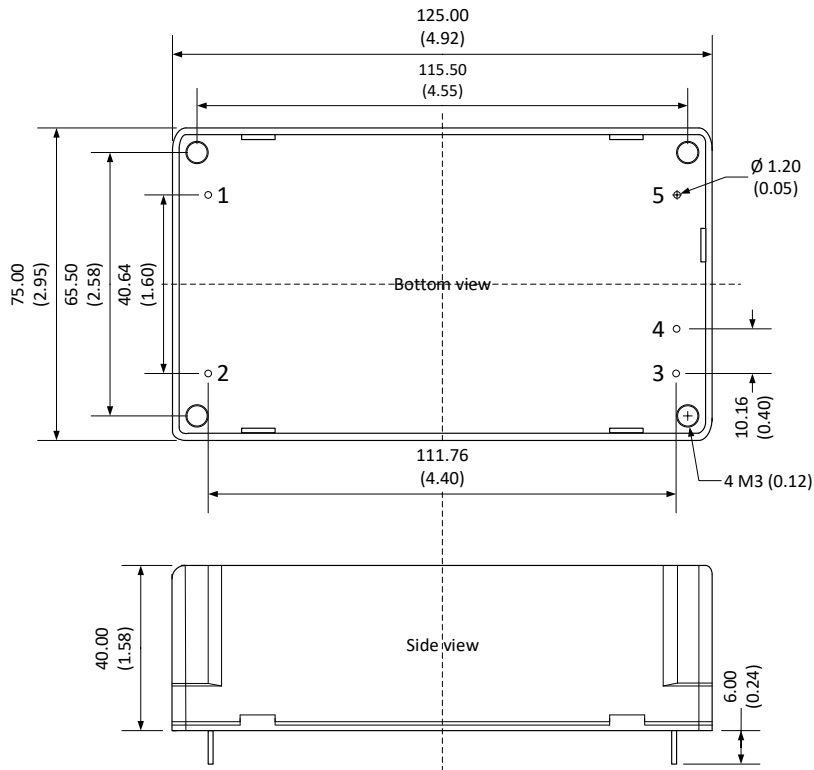

Dimensions mm (inch)
 Case Tolerance ± 0.50 (± 0.02)
 Pin Diameter Tolerance ± 0.10 (± 0.004)
 Pin Length Tolerance ± 1.50 (± 0.06)

Pin Out Specifications

Pin	800VDC Input
1	+Vin
2	-Vin
3	+Vout
4	-Vout
5	N.C.

800VDC input models with optional -ST or -STF bottom plate

Pin Out Specifications

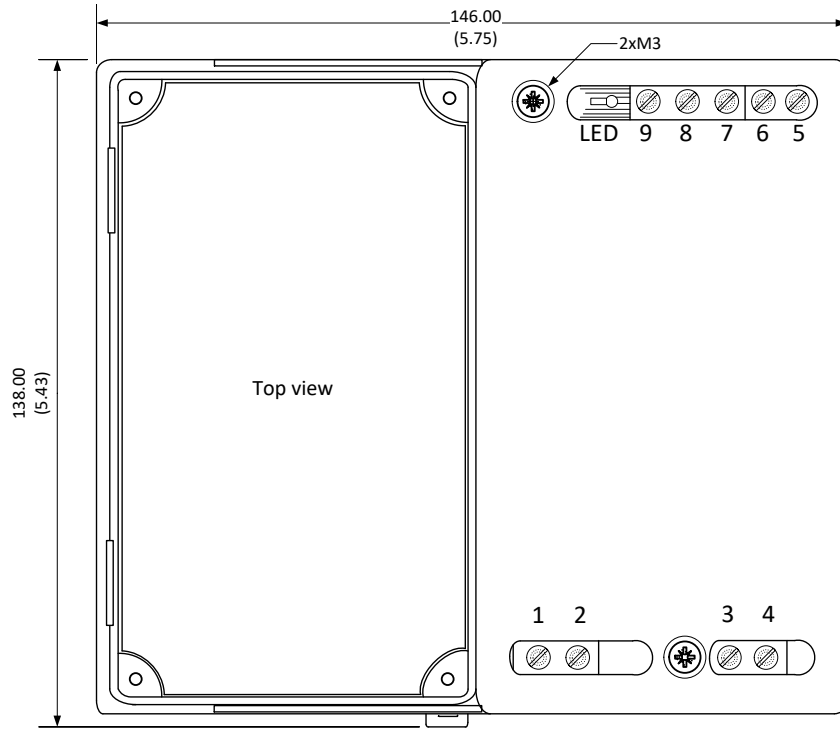

Pin	Single
1	-Vin
2	-Vin
3	+Vin
4	+Vin
5	+Vout
6	-Vout
7	N.C.
8	N.C.
9	N.C.

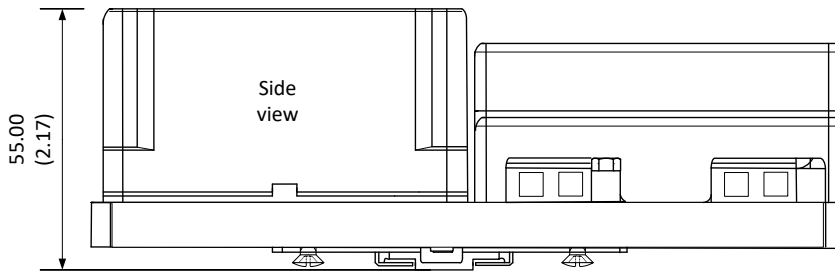

Dimensions mm (inch)
 Installed on DIN rail type TS35
 Wire: 24-12AWG
 Case Tolerance ± 0.50 (± 0.02)
 General Tolerance ± 1.00 (± 0.04)

NOTES:

1. To replace the internal fuse in the models with suffix "-ST", unscrew the 2 screws on the top side of the plate.
2. DIN rail metal holder needs to be grounded.
3. Horizontal mounting recommended.

Derating

600VDC input models

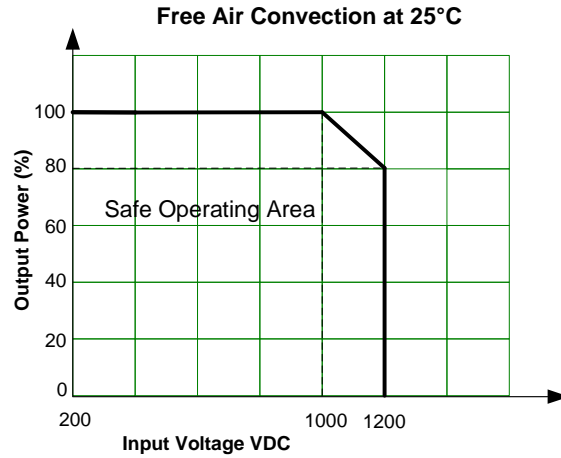
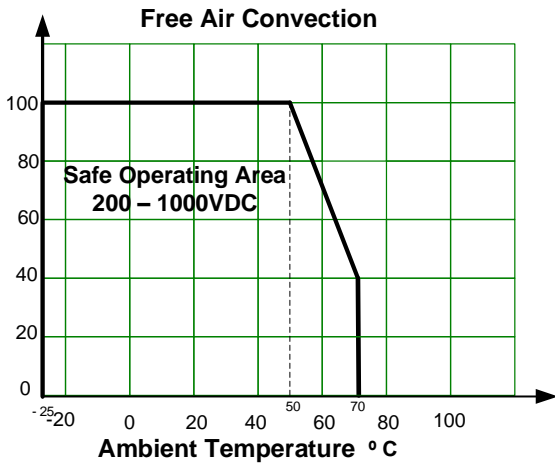

NOTE: 1. For Input Voltage between 1000-1200VDC the derating will depend on the temperature derating.
2. Sufficient air space for natural air flow around must be considered.

800VDC input models*

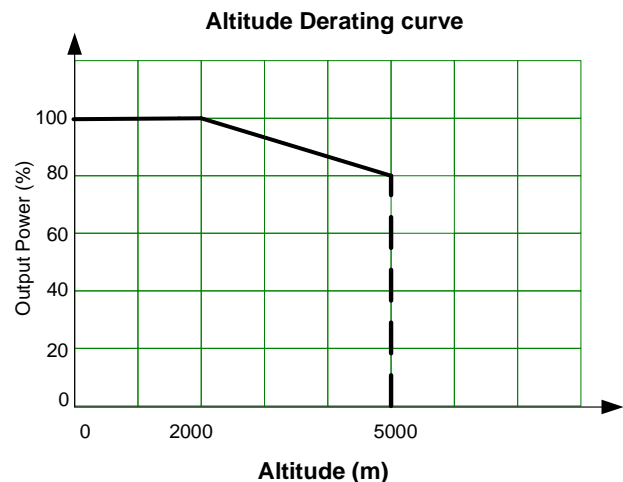
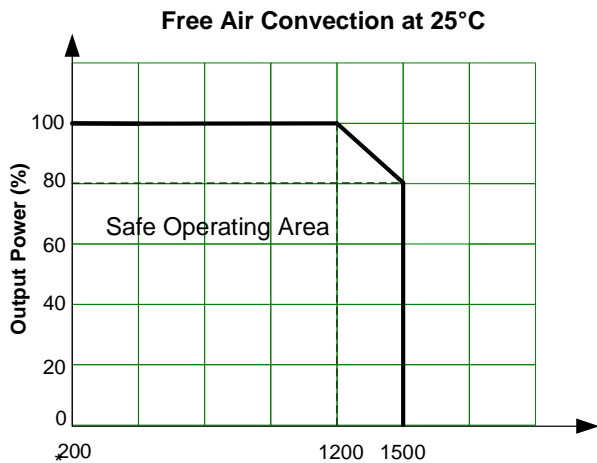
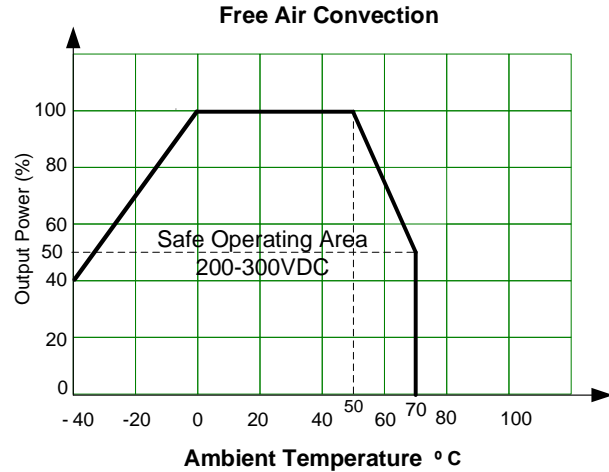
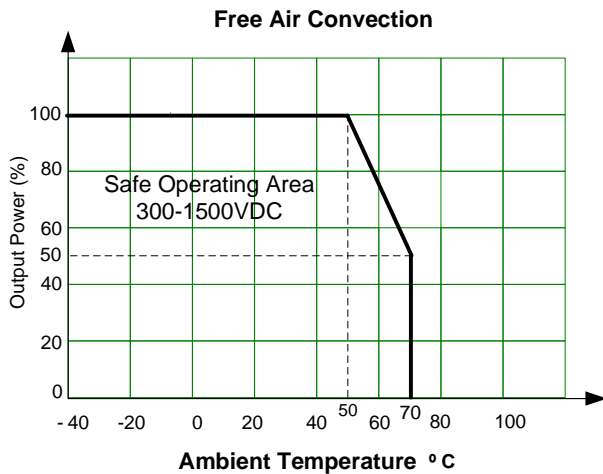

NOTE: 1. Derating is indicated at natural convection. Sufficient air space around is needed.
2. For Input Voltage between 1200-1500VDC the derating will depend on the temperature derating.

Efficiency curves
600VDC input models

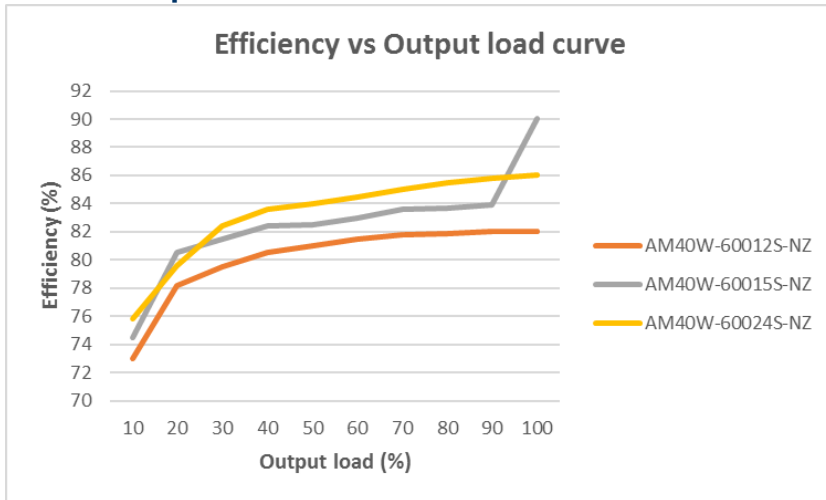

Typical Application circuit

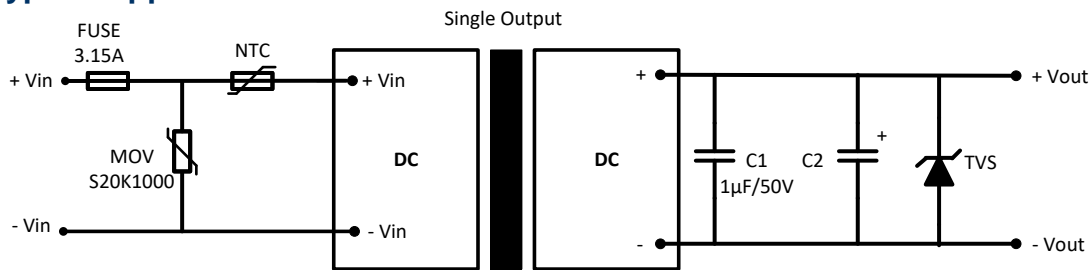

Model	C2	TVS
12 & 15 Vout	220 µF / 35V	20V
24 Vout	120 µF / 35V	30V

*NOTE: For 800VDC Input models NTC and MOV are not needed.

Recommended EMC Circuit

600VDC input models

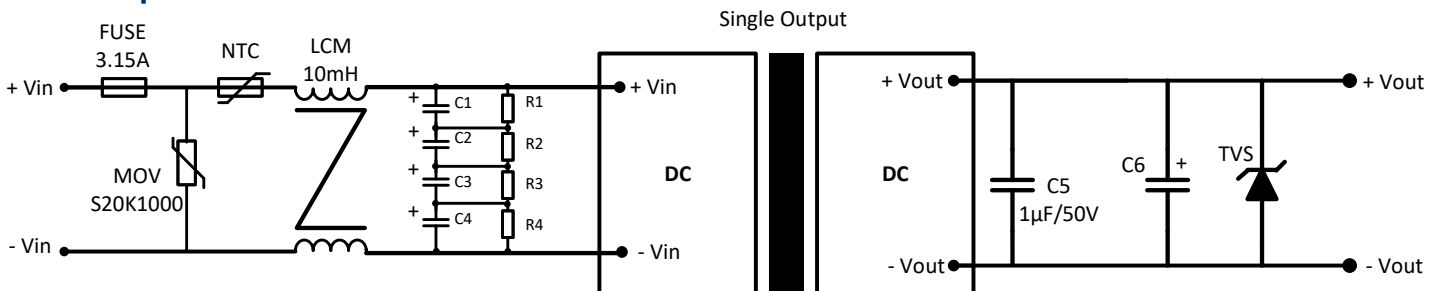

Model	C1, C2, C3 & C4	R1, R2, R3 & R4	C6	TVS
12 & 15 Vout	47 µF/450V	1MΩ / 2W	220 µF / 35V	20V
24 Vout	47 µF/450V	1MΩ / 2W	120 µF / 35V	30V

800VDC input models

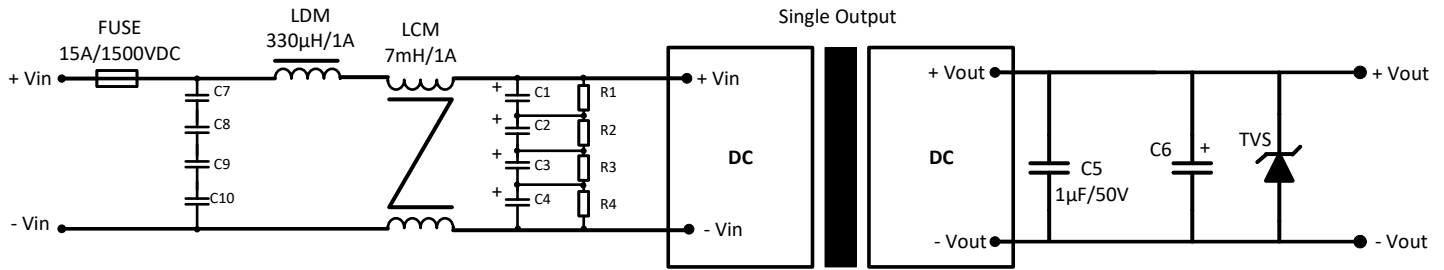

Model	C1, C2, C3 & C4	C7, C8, C9 & C10	R1, R2, R3 & R4	C6	TVS
12 & 15 Vout	47 µF/450V	100 nF/275VAC	1MΩ / 2W	120 µF / 35V	20V
24 Vout				68 µF / 35V	33V

NOTE: **1.** Datasheets are updated as needed and as such, specifications are subject to change without notice. Once printed or downloaded, datasheets are no longer controlled by Aimtec; refer to www.aimtec.com for the most current product specifications. **2.** Product labels shown, including safety agency certifications on labels, may vary based on the date manufactured. **3.** Mechanical drawings and specifications are for reference only. **4.** All specifications are measured at an ambient temperature of 25°C, humidity<75%, nominal input voltage and at rated output load unless otherwise specified. **5.** Aimtec may not have conducted destructive testing or chemical analysis on all internal components and chemicals at the time of publishing this document. CAS numbers and other limited information are considered proprietary and may not be available for release. **6.** This product is not designed for use in critical life support systems, equipment used in hazardous environments, nuclear control systems or other such applications which necessitate specific safety and regulatory standards other the ones listed in this datasheet. **7.** Warranty is in accordance with Aimtec’s standard Terms of Sale available at www.aimtec.com.