

ALMD-EG1E/2E, ALMD-EL1E/2E

High Brightness SMT Round Red, Amber LED Lamps

Description

The Broadcom[®] ALMD-Ex1E/2E series is essentially like a conventional high brightness through holes LED in the form of surface mount device. It can be assembled using common SMT assembly processes and are compatible with industrial reflow soldering processes.

The LEDs are made with an advanced optical grade epoxy for superior performance in outdoor sign applications. For easy pick and place assembly, the LEDs are shipped in tape and reel. Every reel is shipped from a single intensity and color bin for better uniformity.

Features

- Using high brightness AllnGaP material
- Available in Red and Amber
 - Red – AllnGaP 621 nm
 - Amber – AllnGaP 590 nm
- Typical viewing angle: 15° and 23°
- JEDEC MSL 3
- Compatible with industrial reflow soldering process
- Tinted

Applications

Variable message signs

CAUTION! The LEDs are ESD sensitive per ANSI/ESDA/JEDEC JS-001. Please observe appropriate precautions during handling and processing. Refer to Application Note AN-1142 for additional details.

CAUTION! Customers should always keep the LED in the moisture barrier bag (MBB) with < 5% RH when not in use because prolonged exposure to the environment might cause the silver-plated leads to tarnish or rust, which might cause difficulties in soldering.

Figure 1: Package Dimensions

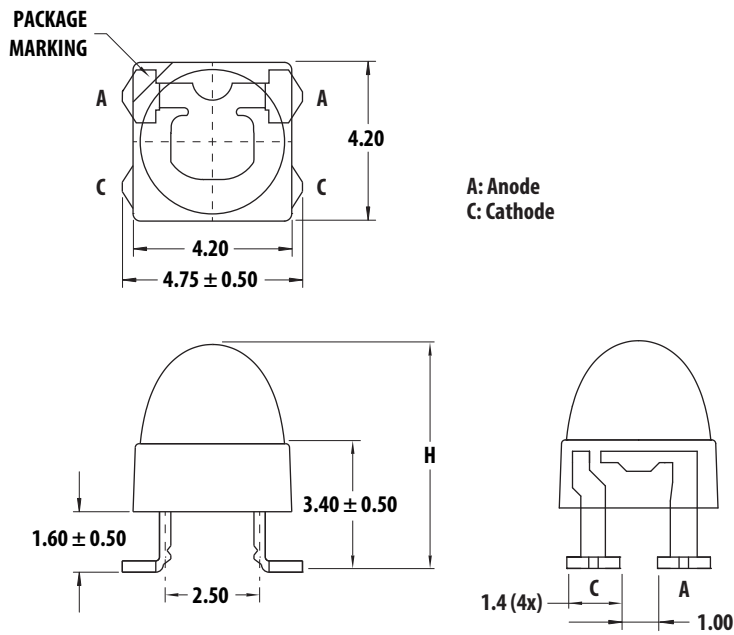

Part Number	Dimension H
ALMD-Ex1x	6.80 ± 0.50
ALMD-Ex2x	6.50 ± 0.50

NOTE:

1. All dimensions in millimeters (inches).
2. Tolerance is ±0.20 mm unless otherwise specified.
3. Mildsteel lead frame.

Device Selection Guide

Table 1: Device Selection Guide

Part Number	Color and Dominant Wavelength λ_d (nm) Typ. ^a	Luminous Intensity I_v (mcd) ^{b, c, d}		Viewing Angle Typ. (°) ^e
		Min.	Max.	
ALMD-EG1E-Z2002	Red 621	12,000	27,000	15°
ALMD-EL1E-Z2002	Amber 590	12,000	27,000	
ALMD-EL1E-Z2K02	Amber 590	12,000	27,000	
ALMD-EL1E-Z2L02	Amber 590	12,000	27,000	
ALMD-EG2E-XZ002	Red 621	7200	16,000	23°
ALMD-EL2E-XZ002	Amber 590	7200	16,000	
ALMD-EL2E-XZK02	Amber 590	7200	16,000	
ALMD-EL2E-XZL02	Amber 590	7200	16,000	

- Dominant wavelength, λ_d , is derived from the CIE Chromaticity Diagram and represents the color of the lamp.
- The luminous intensity is measured on the mechanical axis of the lamp package and it is tested with pulsing condition.
- The optical axis is closely aligned with the package mechanical axis.
- Tolerance for each bin limit is $\pm 15\%$.
- $\theta_{1/2}$ is the off-axis angle where the luminous intensity is half the on-axis intensity.

Part Numbering System

A L M D -

x ₁	x ₂	x ₃	x ₄
----------------	----------------	----------------	----------------

 -

x ₅	x ₆	x ₇	x ₈	x ₉
----------------	----------------	----------------	----------------	----------------

Table 2: Part Numbering System

Code	Description	Option	
x1	Package type	E	Round AlInGaP
x2	Color	G	Red
		L	Amber
x3	Viewing angle	1	15°
		2	23°
x4	Product specific designation	E	
x5	Minimum intensity bin	Refer to selection guide	
x6	Maximum intensity bin	Refer to selection guide	
x7	Color bin	0	Full distribution
		K	Color Bin 2 and 4
		L	Color Bin 4 and 6
x8x9	Packaging option	02	Tested 20 mA, 13-in. carrier tape

Table 3: Intensity Bin Limit Table (1.3:1 Iv Bin Ratio)

Bin	Intensity (mcd) at 20 mA	
	Min.	Max.
X	7200	9300
Y	9300	12000
Z	12000	16000
1	16000	21000
2	21000	27000

Tolerance for each bin limit is $\pm 15\%$.

Table 4: VF Bin Limit Table (V at 20 mA)

Bin	Intensity (mcd) at 20 mA	
	Min.	Max.
VD	1.8	2.0
VA	2.0	2.2
VB	2.2	2.4
VC	2.4	2.5

Tolerance for each bin is $\pm 0.05V$.

Table 5: Red Color Range

Bin	Min. Dom.	Max. Dom.	Chromaticity Coordinate				
			x	y	z	w	
—	618.0	630.0	x	0.6873	0.6696	0.6892	0.7079
			y	0.3126	0.3136	0.2941	0.2920

Tolerance for each bin limit is ± 0.5 nm.

Table 6: Amber Color Range

Bin	Min. Dom.	Max. Dom.	Chromaticity Coordinate				
			x	y	z	w	
1	584.5	587.0	x	0.5420	0.5370	0.5530	0.5570
			y	0.4580	0.4550	0.4400	0.4420
2	587.0	589.5	x	0.5570	0.5530	0.5670	0.5720
			y	0.4420	0.4400	0.4250	0.4270
4	589.5	592.0	x	0.5720	0.5670	0.5820	0.5870
			y	0.4270	0.4250	0.4110	0.4130
6	592.0	594.5	x	0.5870	0.5820	0.5950	0.6000
			y	0.4130	0.4110	0.3980	0.3990

Tolerance for each bin limit is ± 0.5 nm.

Example of bin information on reel and packaging label:

CAT: X → Luminous intensity bin X

BIN: 2 → Color Bin 2

VF: VA → Forward voltage bin VA

Table 7: Absolute Maximum Rating, $T_J = 25^\circ\text{C}$

Parameter	Red/Amber	Units
DC Forward Current ^a	50	mA
Peak Forward Current	100 ^b	mA
Power Dissipation	125	mW
Reverse Voltage	Not recommended for reverse bias	V'
LED Junction Temperature	110	$^\circ\text{C}$
Operating Temperature Range	-40 to +85	$^\circ\text{C}$
Storage Temperature Range	-40 to +100	$^\circ\text{C}$

a. Derate linearly as shown in [Figure 5](#).

b. Duty factor 30%, frequency 1 kHz.

Table 8: Electrical/Optical Characteristics, $T_J = 25^\circ\text{C}$

Parameter	Symbol	Min.	Typ.	Max.	Units	Test Conditions
Forward Voltage Red Amber	V_F	1.8 1.8	2.1 2.1	2.5 2.5	V	$I_F = 20\text{ mA}$
Reverse Voltage ^a Red and Amber	V_R	5			V	$I_R = 10\ \mu\text{A}$
Dominant Wavelength ^b Red Amber	λ_d	618.0 584.5	621.0 590.0	630.0 594.5		$I_F = 20\text{ mA}$
Peak Wavelength Red Amber	λ_{PEAK}		630.0 594.0		nm	Peak of Wavelength of Spectral Distribution at $I_F = 20\text{ mA}$
Thermal Resistance Red Amber	$R_{\theta\text{J-PIN}}$		270 270		$^\circ\text{C/W}$	LED Junction-to-Pin

a. Indicates product final testing condition. Long term reverse bias is not recommended

b. The dominant wavelength is derived from the Chromaticity Diagram and represents the color of the lamp.

Figure 2: Relative Intensity vs. Wavelength

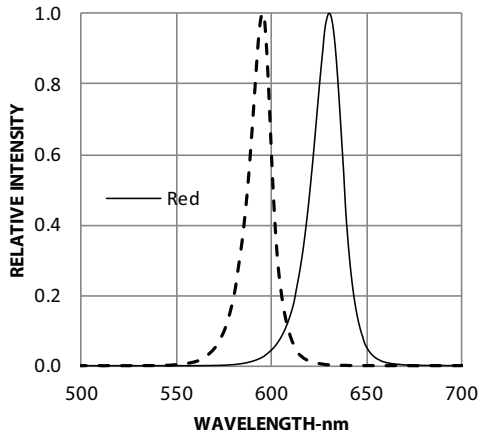

Figure 3: Forward Current vs. Forward Voltage

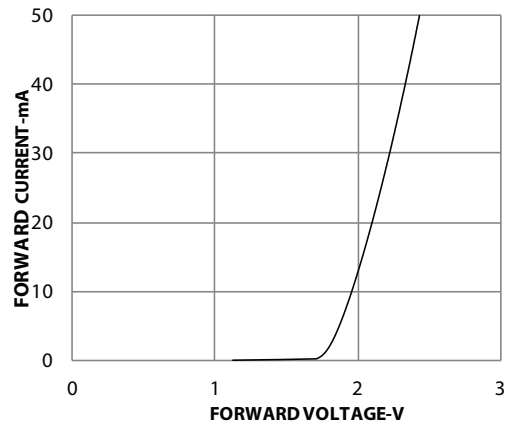

Figure 4: Relative Intensity vs. Forward Current

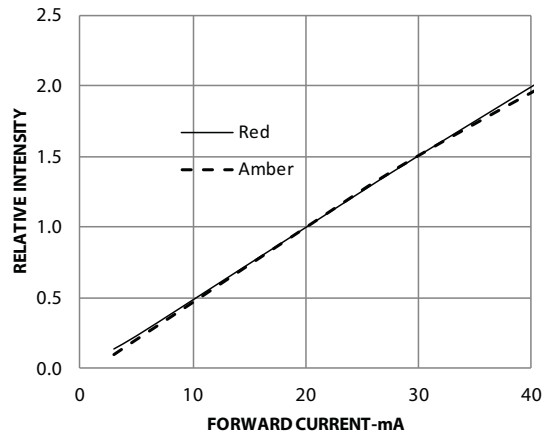

Figure 5: Maximum Forward Current vs. Ambient Temperature

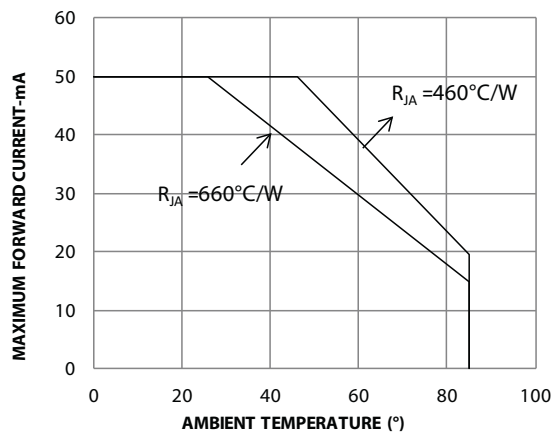

Figure 6: Relative Dominant Wavelength Shift vs. Forward Current

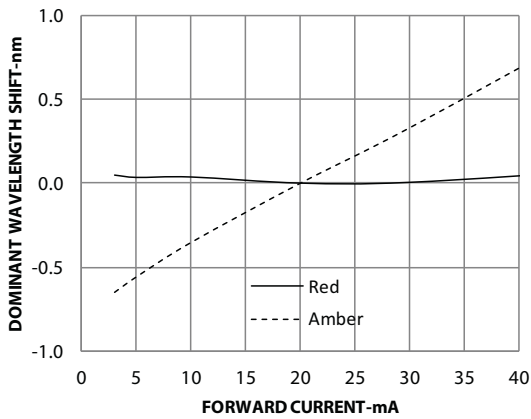

Figure 7: Radiation Pattern for X Axis for 15°

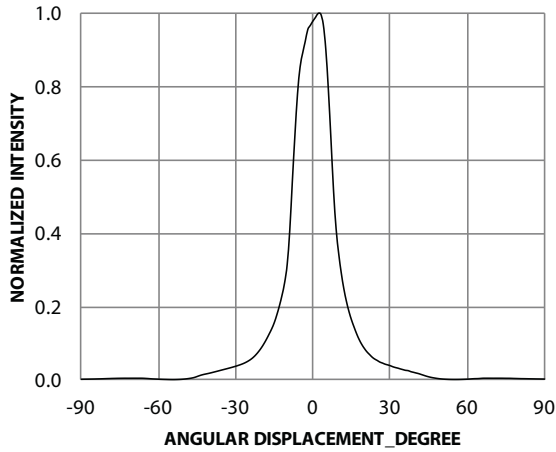

Figure 8: Radiation Pattern for X Axis for 23°

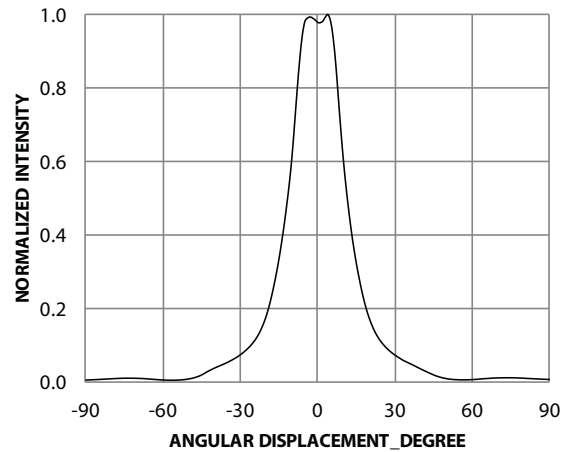

Figure 9: Component Axis for Radiation Pattern

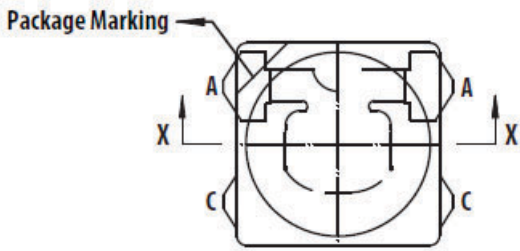

Figure 10: Relative Intensity vs. Junction Temperature

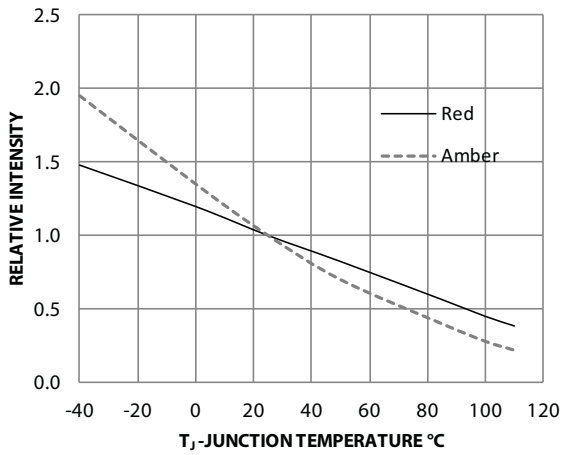

Figure 11: Forward Voltage shift vs. Junction Temperature

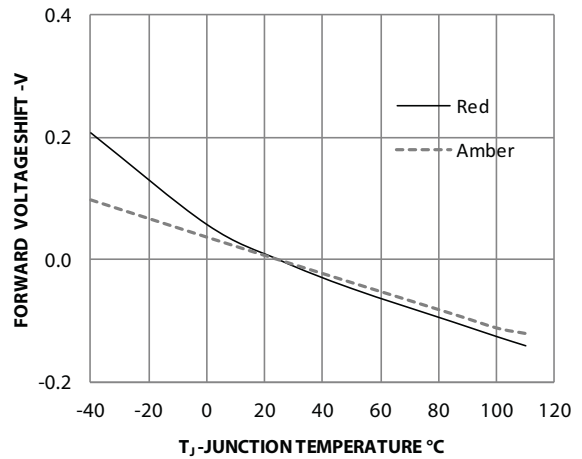

Figure 12: Recommended Soldering Land Pattern

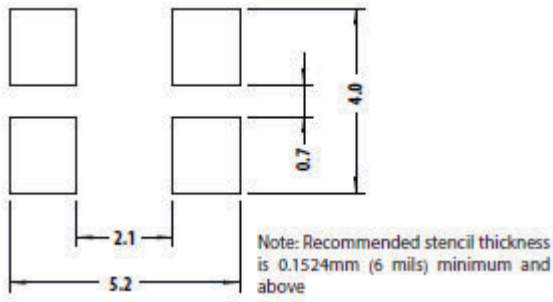

Figure 13: Carrier Tape Dimension

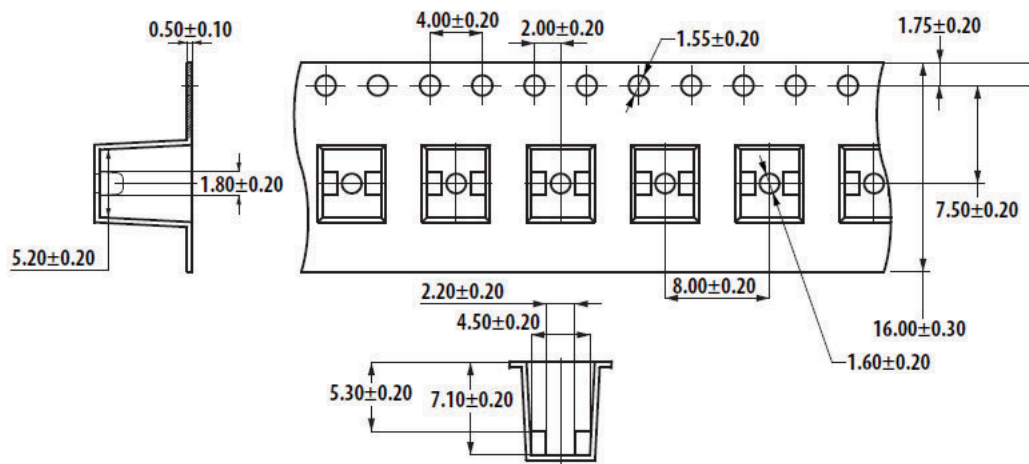

Figure 14: Reel Dimension

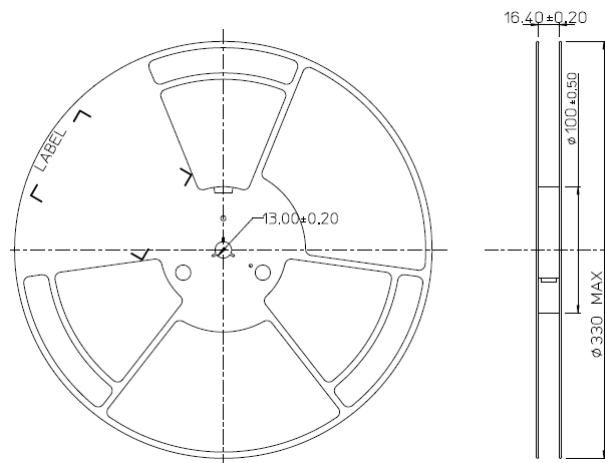
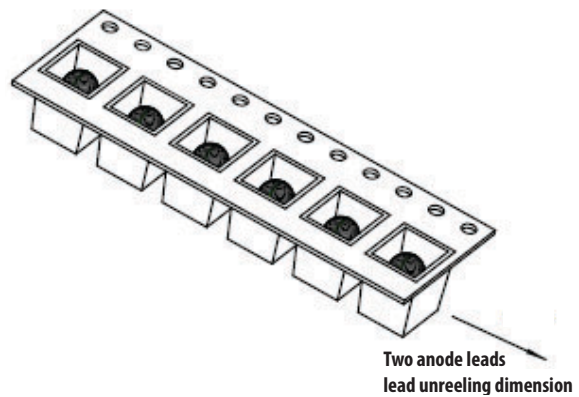

Figure 15: Unit Orientation from Reel



Soldering

Recommended reflow soldering condition.

Figure 16: Leaded Reflow Soldering

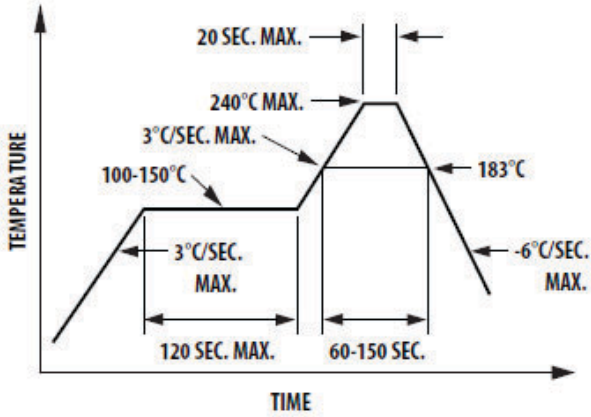

1. Do not perform reflow soldering more than twice. Observe necessary precautions of handling moisture sensitive devices as stated in the next section.
2. Recommended board reflow direction.

Figure 18: Recommended Board Reflow Direction

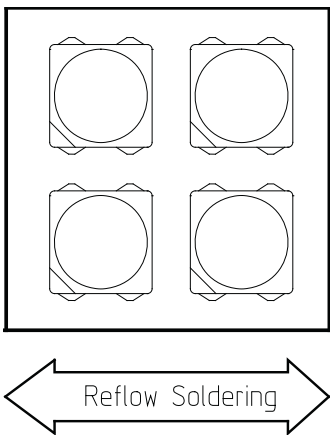
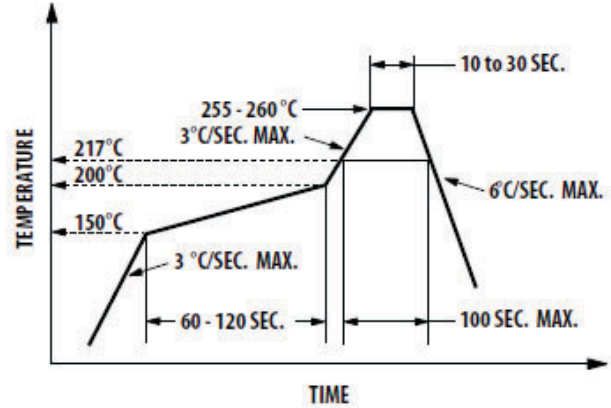

Figure 17: Lead-Free Reflow Soldering



3. Do not apply any pressure or force on the LED during reflow and after reflow while the LED is still hot.
4. Use reflow soldering to solder the LED. Use hand soldering for rework only if unavoidable but must be strictly controlled for the following conditions:
 - Soldering iron tip temperature = 320°C maximum
 - Soldering duration = 3 seconds maximum
 - Number of cycles = 1 only
 - Power of soldering iron = 50W maximum
5. Do not touch the LED body with a hot soldering iron except when soldering the terminals because it might damage the LED.
6. For de-soldering, use an appropriate double-head soldering iron. Confirm beforehand whether the functionality and performance of the LED is affected by hand soldering.

Precautionary Notes

Handling Precautions

For automated pick-and-place, Broadcom has tested the following nozzle size made with a urethane material to work well with this LED. However, due to the possibility of variations in other parameters, such as pick-and-place machine, maker and model, and other settings of the machine, verify the selected nozzle before using it.

Figure 19: Nozzle Size

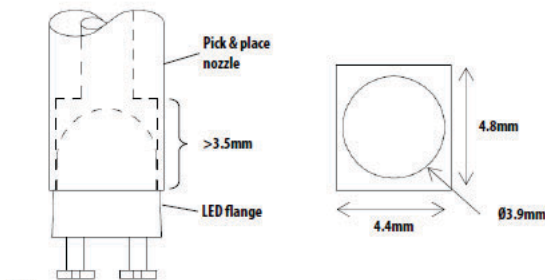

Note:
 (a) Nozzle tip should touch the LED flange during pick and place.
 (b) Outer dimensions of the nozzle should be able to fit into the carrier tape pocket.

Handling of Moisture Sensitive Devices

This product has a Moisture Sensitive Level 3 rating per JEDEC J-STD-020. Refer to Application Note AN-5305, *Handling of Moisture Sensitive Surface Mount Devices*, for additional details and a review of proper handling procedures.

Before use:

- You can store an unopened moisture barrier bag (MBB) at $40^{\circ}\text{C}/90\% \text{ RH}$ for 12 months. If the actual shelf life has exceeded 12 months and the humidity indicator card (HIC) indicates that baking is not required, then it is safe to reflow the LEDs per the original MSL rating.
- Do not open the MBB prior to assembly (for example, for IQC).

Control after opening the MBB:

- Read the HIC immediately upon opening the MBB.
- Keep the LEDs at $30^{\circ}\text{C}/60\% \text{ RH}$ at all times, and complete all high temperature-related processes, including soldering, curing, or rework, within 168 hours.

Control for unfinished reel:

Store unused LEDs in a sealed MBB with desiccant or desiccator at <math><5\% \text{ RH}</math>.

Control of assembled boards:

If the PCB soldered with the LEDs is to be subjected to other high-temperature processes, store the PCB in a sealed MBB with desiccant or desiccator at <math><5\% \text{ RH}</math> to ensure that all LEDs have not exceeded their floor life of 168 hours.

Baking is required if the following conditions exist:

- The HIC indicator is not BROWN at 10% and is AZURE at 5%.
- The LEDs are exposed to conditions of $>30^{\circ}\text{C}/60\% \text{ RH}$ at any time.
- The LED floor life exceeded 168 hours.

The recommended baking condition is: $60^{\circ}\text{C} \pm 5^{\circ}\text{C}$ for 20 hours. Baking should only be done once.

Storage:

The soldering terminals of these Broadcom LEDs are silver plated. If the LEDs are exposed in ambient environments for too long, the silver plating might oxidize; thus affecting their solderability performance. As such, keep unused LEDs in a sealed MBB with desiccant or in desiccator at <math><5\% \text{ RH}</math>.

Application Precautions

- The drive current of the LED must not exceed the maximum allowable limit across temperature as stated in the data sheet. Constant current driving is recommended to ensure consistent performance.
- LEDs exhibit slightly different characteristics at different drive currents, which might result in larger performance variations (that is, intensity, wavelength, and forward voltage). Set the application current as close as possible to the test current to minimize these variations.
- The LED is not intended for reverse bias. Use other appropriate components for such purposes. When driving the LED in matrix form, it is critical to ensure that the reverse bias voltage does not exceed the allowable limit of the LED.
- Avoid rapid changes in ambient temperatures, especially in high-humidity environments, because this situation causes condensation on the LED.

- If the LED is intended to be used in outdoor or harsh environments, protect the LED leads with a suitable potting material against damages caused by rain water, oil, corrosive gases and so on. Use a louver or a shade to reduce direct sunlight on the LEDs.
- The number of reflow cycles and reflow temperature conditions used might affect the optical characteristics of the LED. Use LEDs with the same number of reflow cycles and same reflow temperature conditions within the same finished product.

Eye Safety Precautions

LEDs might pose optical hazards when in operation. Do not look directly at an operating LED as it might be harmful to the eyes. For safety reasons, use appropriate shielding or personal protective equipments.

Disclaimer

Broadcom's products are not specifically designed, manufactured or authorized for sale as parts, components, or assemblies for the planning, construction, maintenance, or direct operation of a nuclear facility or for use in medical devices or applications. The customer is solely responsible, and waives all rights to make claims against Broadcom or its suppliers, for all loss, damage, expense, or liability in connection with such use.

Broadcom, the pulse logo, Connecting everything, Avago Technologies, Avago, and the A logo are among the trademarks of Broadcom and/or its affiliates in the United States, certain other countries, and/or the EU.

Copyright © 2016–2019 Broadcom. All Rights Reserved.

The term “Broadcom” refers to Broadcom Inc. and/or its subsidiaries. For more information, please visit www.broadcom.com.

Broadcom reserves the right to make changes without further notice to any products or data herein to improve reliability, function, or design. Information furnished by Broadcom is believed to be accurate and reliable. However, Broadcom does not assume any liability arising out of the application or use of this information, nor the application or use of any product or circuit described herein, neither does it convey any license under its patent rights nor the rights of others.

