

# ACPL-W60L and ACPL-K63L

High Speed LVTTTL Compatible 3.3 Volt/5 Volt Optocouplers



## Data Sheet



### Description

The ACPL-W60L/K63L are optically coupled gates that combine a GaAsP light emitting diode and an integrated high gain photo detector. The output of the detector IC is an open collector Schottky-clamped transistor. The internal shield provides a guaranteed common mode transient immunity specification of 15 kV/ $\mu$ s at 3.3V.

This unique design provides maximum AC and DC circuit isolation while achieving LVTTTL/LVCMOS compatibility. The optocoupler AC and DC operational parameters are guaranteed from  $-40^{\circ}\text{C}$  to  $+85^{\circ}\text{C}$  allowing trouble-free system performance.

### Functional Diagram

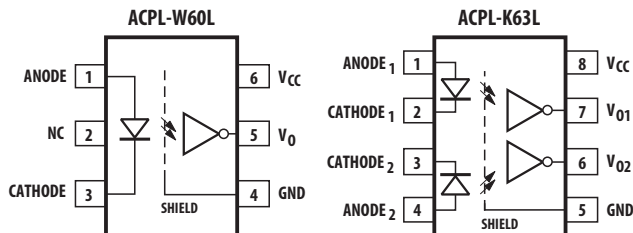

TRUTH TABLE  
(POSITIVE LOGIC)

LED	OUTPUT
ON	L
OFF	H

A 0.1  $\mu$ F bypass capacitor must be connected between pins 4 and 6 for ACPL-W60L and pins 5 and 8 for ACPL-K63L.

### Features

- Dual Voltage Operation (3.3V/5V)
- Package clearance/creepage at 8 mm
- Low power consumption
- 15 kV/ $\mu$ s minimum Common Mode Rejection (CMR) at  $V_{CM} = 1000\text{V}$
- High speed: 15 MBd typical
- LVTTTL/LVCMOS compatible
- Low input current capability: 5 mA
- Guaranteed AC and DC performance over temperature:  $-40^{\circ}\text{C}$  to  $+85^{\circ}\text{C}$
- Available in 6-pin stretched SO-6 and 8 pin stretched SO-8
- Safety approvals: UL, CSA, IEC/EN/DIN EN 60747-5-2

### Applications

- Isolated line receiver
- Computer-peripheral interfaces
- Microprocessor system interfaces
- Digital isolation for A/D, D/A conversion
- Switching power supply
- Instrument input/output isolation
- Ground loop elimination
- Pulse transformer replacement
- Fieldbus

**CAUTION:** It is advised that normal static precautions be taken in handling and assembly of this component to prevent damage and/or degradation which may be induced by ESD.

## Schematic Diagrams

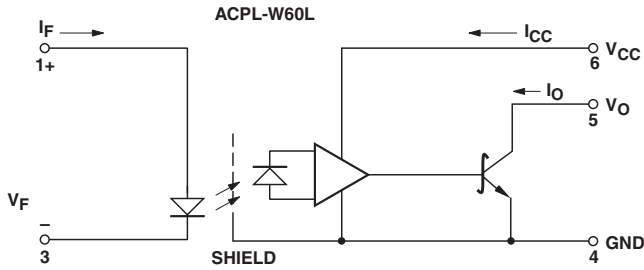

USE OF A 0.1  $\mu$ F BYPASS CAPACITOR CONNECTED BETWEEN PINS 5 AND 8 IS RECOMMENDED (SEE NOTE 5).

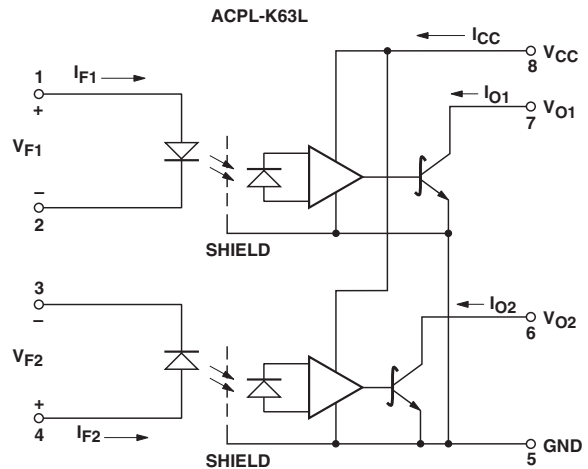

These optocouplers are suitable for high speed logic interfacing, input/output buffering, as line receivers in environments that conventional line receivers cannot tolerate and are recommended for use in extremely high ground or induced noise environments.

These optocouplers are available in stretched SO-6 and SO-8 package. The part numbers are as follows:

Part number	Package
ACPL-W60L	Stretched SO-6
ACPL-K63L	Stretched SO-8

## Ordering Information

ACPL-xxxx is UL Recognized with 5000  $V_{rms}$  for 1 minute per UL1577 and is approved under CSA Component Acceptance Notice #5, File CA 88324.

Part Number	Option		Surface Mount	Gull Wing	Tape & Reel	UL 5000 $V_{rms}$ / 1 Minute rating	IEC/EN/DIN EN 60747-5-2	Quantity
	RoHS Compliant	Package						
ACPL-W60L	-000E	Stretched	X			X		100 per tube
	-500E	SO-6	X		X	X		1000 per reel
	-560E		X		X	X	X	1000 per reel
ACPL-K63L	-000E	Stretched	X			X		80 per tube
	-500E	SO-8	X		X	X		1000 per reel
	-560E		X		X	X	X	1000 per reel

To order, choose a part number from the part number column and combine with the desired option from the option column to form an order entry.

Example 1:

ACPL-W60L-560E to order product of Stretched SO-6 Surface Mount package in Tape and Reel packaging with IEC/EN/DIN EN 60747-5-2 Safety Approval in RoHS compliant.

Option datasheets are available. Contact your Avago sales representative or authorized distributor for information.

## Package Outline Drawings

### ACPL-W60L Stretched SO-6 Package

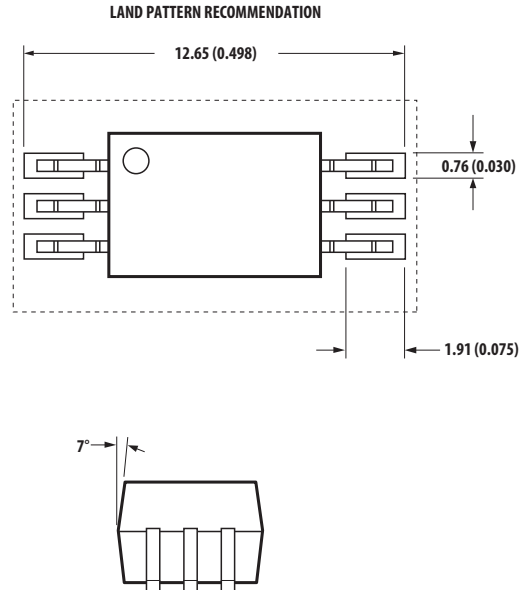
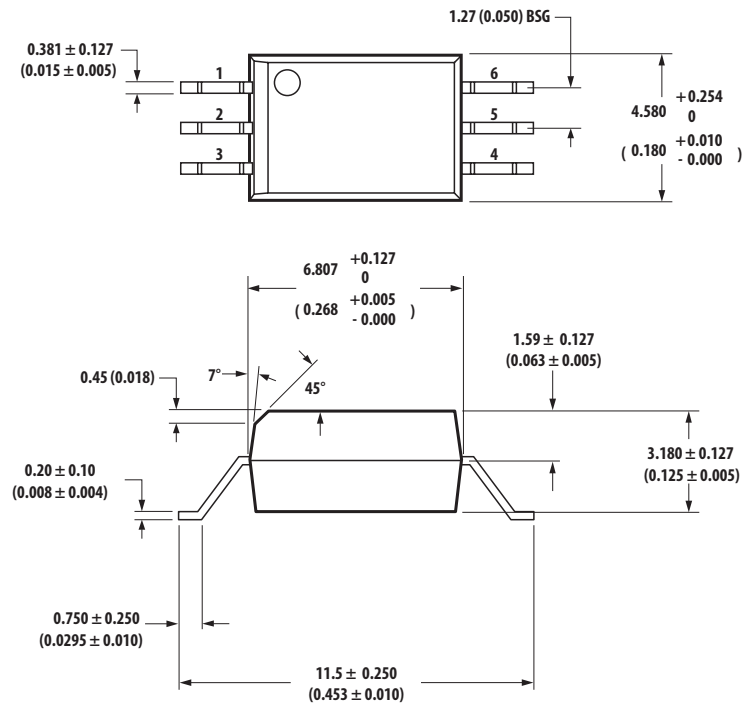

DIMENSIONS IN MILLIMETERS (INCHES).  
LEAD COPLANARITY = 0.1 mm (0.004 INCHES).

### ACPL-K63L Stretched SO-8 Package

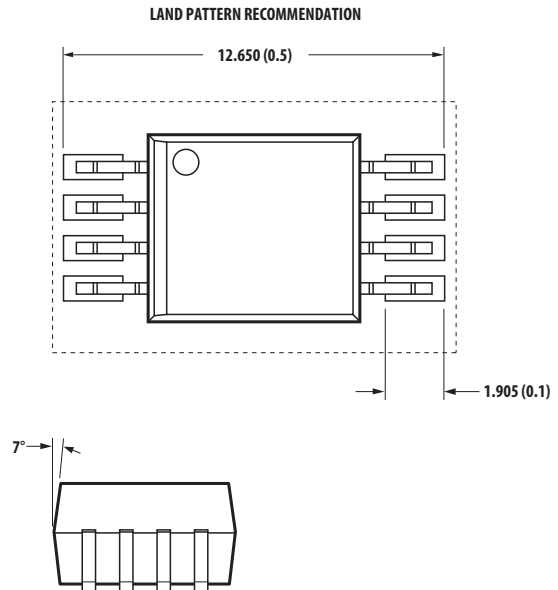
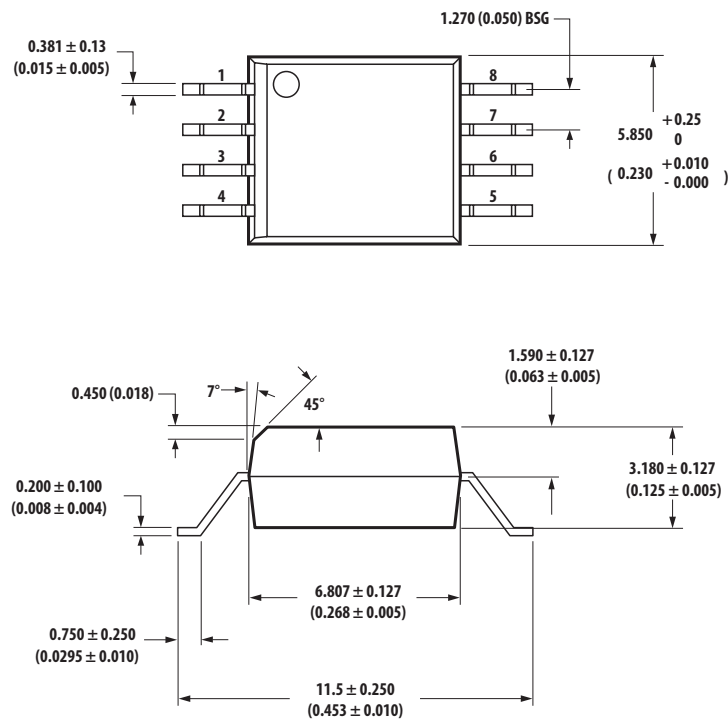

DIMENSIONS IN MILLIMETERS (INCHES).  
LEAD COPLANARITY = 0.1 mm (0.004 INCHES).

## Recommended Solder Reflow Thermal Profile

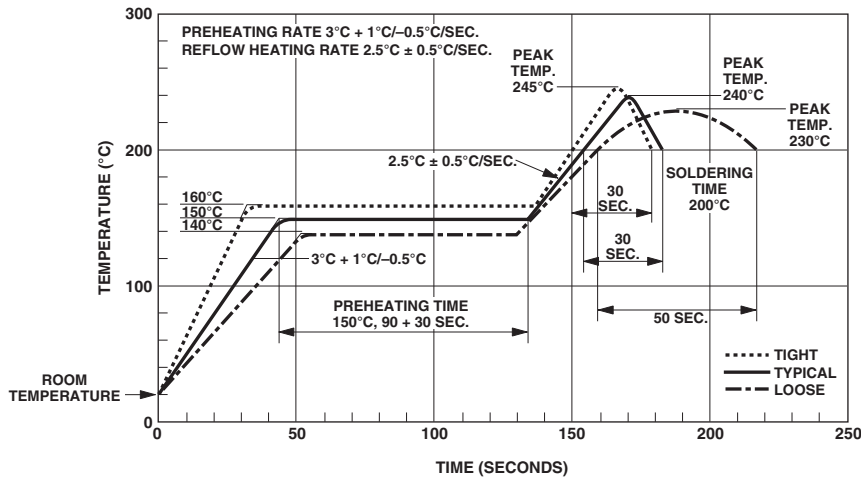

Note: Non-halide flux should be used.

## Recommended PB-Free IR Profile

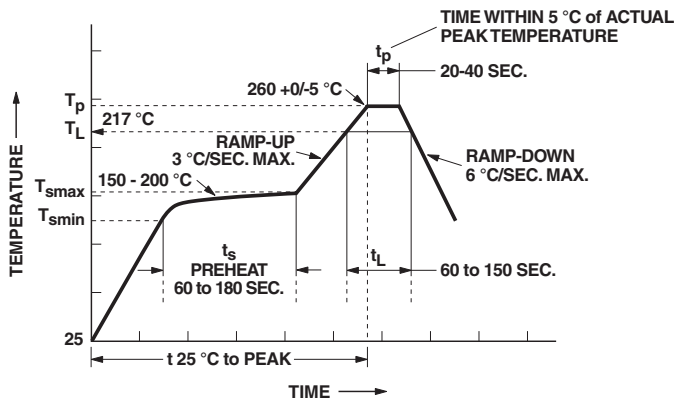

NOTES:  
 THE TIME FROM 25 °C TO PEAK TEMPERATURE = 8 MINUTES MAX.  
 $T_{smax} = 200^{\circ}\text{C}$ ,  $T_{smin} = 150^{\circ}\text{C}$

Note: Non-halide flux should be used.

## Regulatory Information

The ACPL-W60L/K63L have been approved by the following organizations:

### UL

Approval under UL 1577, Component Recognition Program, File E55361.

### CSA

Approval under CSA Component Acceptance Notice #5, File CA 88324.

### IEC/EN/DIN EN 60747-5-2

Approved under:

IEC 60747-5-2:1997 + A1:2002

EN 60747-5-2:2001 + A1:2002

DIN EN 60747-5-2 (VDE 0884Teil 2):2003-01 Option 060 only)

## Insulation and Safety Related Specifications

Parameter	Symbol	Stretched S0-6 and S0-8		Conditions
		Value	Units	
Minimum External Air Gap (External Clearance)	L (101)	8	mm	Measured from input terminals to output terminals, shortest distance through air.
Minimum External Tracking (External Creepage)	L (102)	8	mm	Measured from input terminals to output terminals, shortest distance path along body.
Minimum Internal Plastic Gap (Internal Clearance)		0.08	mm	Through insulation distance, conductor to conductor, usually the direct distance between the photoemitter and photodetector inside the optocoupler cavity.
Tracking Resistance (Comparative Tracking Index)	CTI	175	Volts	DIN IEC 112/VDE 0303 Part 1
Isolation Group		IIla		Material Group (DIN VDE 0110, 1/89, Table 1)

## IEC/EN/DIN EN 60747-5-2 Insulation Related Characteristics

Description	Symbol	Stretched S0-6 & S0-8 Value	Units
Installation classification per DIN VDE 0110/1.89, Table 1			
for rated mains voltage $\leq 150$ V rms		I-IV	
for rated mains voltage $\leq 300$ V rms		I-III	
for rated mains voltage $\leq 450$ V rms		I-III	
for rated mains voltage $\leq 600$ V rms		I-III	
for rated mains voltage $\leq 1000$ V rms		I-II	
Climatic Classification		55/85/21	
Pollution Degree (DIN VDE 0110/1.89)		2	
Maximum Working Insulation Voltage	$V_{IORM}$	1140	$V_{peak}$
Input to Output Test Voltage, Method b*			
$V_{IORM} \times 1.875 = V_{PR}$ , 100% Production Test with $t_m = 1$ sec, Partial Discharge $< 5$ pC	$V_{PR}$	2137	$V_{peak}$
Input to Output Test Voltage, Method a*			
$V_{IORM} \times 1.5 = V_{PR}$ , Type and Sample Test, $t_m = 60$ sec, Partial Discharge $< 5$ pC	$V_{PR}$	1710	$V_{peak}$
Highest Allowable Overvoltage* (Transient Overvoltage, $t_{ini} = 10$ sec)	$V_{IOTM}$	8000	$V_{peak}$
Safety Limiting Values			
Case Temperature	$T_S$	175	$^{\circ}C$
Input Current	$I_{S,INPUT}$	230	mA
Output Power	$P_{S,OUTPUT}$	600	mW
Insulation Resistance at $T_S$ , $V_{IO} = 500$ V	$R_S$	$\geq 10^9$	$\Omega$

### Notes:

\* Refer to the front of the optocoupler section of the current catalog, under Product Safety Regulations section IEC/EN/DIN EN 60747-5-2, for a detailed description.

1. Isolation characteristics are guaranteed only within the safety maximum ratings which must be ensured by protective circuits in application.

**Absolute Maximum Ratings (No Derating Required up to 85 °C)**

Parameter	Symbol	Package**	Min.	Max.	Units	Note
Storage Temperature	T <sub>S</sub>		-55	125	°C	
Operating Temperature†	T <sub>A</sub>		-40	85	°C	
Average Forward Input Current	I <sub>F</sub>	Single Stretched SO-6		20	mA	2
		Dual Stretched SO-8		15		
Reverse Input Voltage	V <sub>R</sub>			5	V	1
Input Power Dissipation	P <sub>I</sub>			40	mW	
Supply Voltage (1 Minute Maximum)	V <sub>CC</sub>			7	V	
Output Collector Current	I <sub>O</sub>			50	mA	1
Output Collector Voltage	V <sub>O</sub>			7	V	1
Output Power Dissipation	P <sub>O</sub>	Single Stretched SO-6		85	mW	
		Dual Stretched SO-8		60		
Solder Reflow Temperature Profile			See Package Outline Drawings section			

\*\*Ratings apply to all devices except otherwise noted in the Package column.

**Recommended Operating Conditions**

Parameter	Symbol	Min.	Max.	Units
Input Current, Low Level	I <sub>FL</sub> *	0	250	μA
Input Current, High Level <sup>[1]</sup>	I <sub>FH</sub> **	5	15	mA
Power Supply Voltage	V <sub>CC</sub>	2.7	3.6	V
		4.5	5.5	V
Operating Temperature	T <sub>A</sub>	-40	85	°C
Fan Out (at R <sub>L</sub> = 1 kΩ) <sup>[1]</sup>	N		5	TTL Loads
Output Pull-up Resistor	R <sub>L</sub>	330	4 k	Ω

\*The off condition can also be guaranteed by ensuring that V<sub>FL</sub> ≤ 0.8 volts.

\*\*The initial switching threshold is 5 mA or less. It is recommended that 6.3 mA to 10 mA be used for best performance and to permit at least a 20% LED degradation guardband.

## Electrical Specifications

Over Recommended Operating Conditions ( $T_A = -40^\circ\text{C}$  to  $+85^\circ\text{C}$ ,  $2.7\text{V} \leq V_{CC} \leq 3.6\text{V}$ ) unless otherwise specified. All Typical at  $V_{CC} = 3.3\text{V}$ ,  $T_A = 25^\circ\text{C}$ .

Parameter	Sym.	Device	Min.	Typ.	Max.	Units	Test Conditions	Fig.	Note
High Level Output Current	$I_{OH}^*$			4.5	50	$\mu\text{A}$	$V_{CC} = 3.3\text{V}$ , $V_O = 3.3\text{V}$ , $I_F = 250\ \mu\text{A}$	1	1
Input Threshold Current	$I_{TH}$			3.0	5.0	$\text{mA}$	$V_{CC} = 3.3\text{V}$ , $V_O = 0.6\text{V}$ , $I_{OL}(\text{Sinking}) = 13\text{mA}$	2	
Low Level Output Voltage	$V_{OL}^*$			0.35	0.6	$\text{V}$	$V_{CC} = 3.3\text{V}$ , $I_F = 5\text{mA}$ , $I_{OL}(\text{Sinking}) = 13\text{mA}$	3	
High Level Supply Current	$I_{CCH}$	Single		4.7	7.0	$\text{mA}$	$I_F = 0\text{mA}$		
		Dual		6.9	10.0		$V_{CC} = 3.3\text{V}$		
Low Level Supply Current	$I_{CCL}$	Single		7.0	10.0	$\text{mA}$	$I_F = 10\text{mA}$		
		Dual		8.7	15.0		$V_{CC} = 3.3\text{V}$		
Input Forward Voltage	$V_F$		1.4	1.5	1.75*	$\text{V}$	$T_A = 25^\circ\text{C}$ , $I_F = 10\text{mA}$	5	1
Input Reverse Breakdown Voltage	$BV_R^*$		5			$\text{V}$	$I_R = 10\ \mu\text{A}$		1
Input Diode Temperature Coefficient	$\Delta V_F / \Delta T_A$			-1.6		$\text{mV}/^\circ\text{C}$	$I_F = 10\text{mA}$		1
Input Capacitance	$C_{IN}$			60		$\text{pF}$	$f = 1\text{MHz}$ , $V_F = 0\text{V}$		1

## Electrical Specifications (DC)

Over recommended operating conditions ( $T_A = -40^\circ\text{C}$  to  $+85^\circ\text{C}$ ,  $4.5\text{V} \leq V_{DD} \leq 5.5\text{V}$ ) unless otherwise specified. All typicals at  $V_{CC} = 5\text{V}$ ,  $T_A = 25^\circ\text{C}$ .

Parameter	Symbol	Device	Min.	Typ.*	Max.	Units	Test Conditions	Fig.	Note
High Level Output Current	$I_{OH}$			5.5	100	$\mu\text{A}$	$V_{CC} = 5.5\text{V}$ , $V_O = 5.5\text{V}$ , $I_{FL} = 250\ \mu\text{A}$	1	1
Input Threshold Current	$I_{TH}$			2.0	5.0	$\text{mA}$	$V_{CC} = 5.5\text{V}$ , $V_O = 0.6\text{V}$ , $I_{OL} > 13\text{mA}$	2	
Low Level Output Voltage	$V_{OL}$			0.35	0.6	$\text{V}$	$V_{CC} = 5.5\text{V}$ , $I_F = 5\text{mA}$ , $I_{OL}(\text{sinking}) = 13\text{mA}$	3	
High Level Supply Current	$I_{CCH}$	Single		7.0	10.0	$\text{mA}$	$V_{CC} = 5.5\text{V}$ , $I_F = 0\text{mA}$		
		Dual		10.0	15.0	$\text{mA}$	$V_{CC} = 5.5\text{V}$ , $I_F = 0\text{mA}$		
Low Level Supply Current	$I_{CCL}$	Single		9.0	13.0	$\text{mA}$	$V_{CC} = 5.5\text{V}$ , $I_F = 10\text{mA}$		
		Dual		13.0	21.0	$\text{mA}$	$V_{CC} = 5.5\text{V}$ , $I_F = 10\text{mA}$		
Input Forward Voltage	$V_F$		1.4	1.5	1.75	$\text{V}$	$T_A = 25^\circ\text{C}$ , $I_F = 10\text{mA}$	5	1
			1.3		1.8				
Input Reverse Breakdown Voltage	$BV_R$		5			$\text{V}$	$I_R = 10\ \mu\text{A}$		1
Input Diode Temperature Coefficient	$\Delta V_F / \Delta T_A$			-1.6		$\text{mV}/^\circ\text{C}$	$I_F = 10\text{mA}$		1
Input Capacitance	$C_{IN}$			60		$\text{pF}$	$f = 1\text{MHz}$ , $V_F = 0\text{V}$		1

\*All Typical at  $T_A = 25^\circ\text{C}$ ,  $V_{CC} = 5\text{V}$

## Switching Specifications

Over Recommended Temperature ( $T_A = -40^\circ\text{C}$  to  $+85^\circ\text{C}$ ),  $V_{CC} = 3.3\text{ V}$ ,  $I_F = 7.5\text{ mA}$  unless otherwise specified.  
All Typicals at  $T_A = 25^\circ\text{C}$ ,  $V_{CC} = 3.3\text{ V}$ .

Parameter	Sym.	Min.	Typ.	Max.	Units	Test Conditions	Fig.	Note
Propagation Delay Time to High Output Level	$t_{PLH}$			90	ns	$R_L = 350\ \Omega$ $C_L = 15\text{ pF}$	6, 7, 8	1, 6
Propagation Delay Time to Low Output Level	$t_{PHL}$			75	ns			1, 7
Pulse Width Distortion	$ t_{PHL} - t_{PLH} $			25	ns		8	9
Propagation Delay Skew	$t_{PSK}$			40	ns			8, 9
Output Rise Time (10-90%)	$t_r$		45		ns			1
Output Fall Time (90-10%)	$t_f$		20		ns			1

## Switching Specifications (AC)

Over recommended operating conditions  $T_A = -40^\circ\text{C}$  to  $85^\circ\text{C}$ ,  $V_{CC} = 5\text{ V}$ ,  $I_F = 7.5\text{ mA}$  unless otherwise specified.  
All typicals at  $V_{CC} = 5\text{ V}$ ,  $T_A = 25^\circ\text{C}$ .

Parameter	Symbol	Min.	Typ.	Max.	Units	Test Conditions	Fig.	Note
Propagation Delay Time to High Output Level	$t_{PLH}$	20	48	75	ns	$T_A = 25^\circ\text{C}$ , $R_L = 350\ \Omega$ , $C_L = 15\text{ pF}$	6,7,8	1,6
				100	ns	$R_L = 350\ \Omega$ , $C_L = 15\text{ pF}$		
Propagation Delay Time to Low Output Level	$t_{PHL}$	25	50	75	ns	$T_A = 25^\circ\text{C}$ , $R_L = 350\ \Omega$ , $C_L = 15\text{ pF}$		1,7
				100	ns	$R_L = 350\ \Omega$ , $C_L = 15\text{ pF}$		
Pulse Width Distortion	$ t_{PHL} - t_{PLH} $		3.5	35	ns	$R_L = 350\ \Omega$ , $C_L = 15\text{ pF}$	8	9
Propagation Delay Skew	$t_{psk}$			40	ns	$R_L = 350\ \Omega$ , $C_L = 15\text{ pF}$		8,9
Output Rise Time (10%-90%)	$t_r$		24		ns	$R_L = 350\ \Omega$ , $C_L = 15\text{ pF}$		1
Output Fall Time (10%-90%)	$t_f$		10		ns	$R_L = 350\ \Omega$ , $C_L = 15\text{ pF}$		1



Parameter	Sym.	Device	Min.	Typ.	Units	Test Conditions	Fig.	Note
Output High Level Common Mode Transient Immunity	CM <sub>H</sub>	ACPL-W60L ACPL-K63L	15	25	kV/ $\mu$ s	V <sub>CC</sub> = 3.3 V, I <sub>F</sub> = 0 mA, V <sub>O(MIN)</sub> = 2 V, R <sub>L</sub> = 350 $\Omega$ , T <sub>A</sub> = 25°C, V <sub>CM</sub> = 1000 V and V <sub>CM</sub> = 10 V	9	10, 12
Output Low Level Common Mode Transient Immunity	CM <sub>L</sub>	ACPL-W60L ACPL-K63L	15	25	kV/ $\mu$ s	V <sub>CC</sub> = 3.3 V, I <sub>F</sub> = 7.5 mA, V <sub>O(MAX)</sub> = 0.8 V, R <sub>L</sub> = 350 $\Omega$ , T <sub>A</sub> = 25°C, V <sub>CM</sub> = 1000 V and V <sub>CM</sub> = 10 V	9	10, 12
Output High Level Common Mode Transient Immunity	CM <sub>H</sub>	ACPL-W60L ACPL-K63L	10	15	kV/ $\mu$ s	V <sub>CC</sub> = 5 V, I <sub>F</sub> = 0 mA, V <sub>O(MIN)</sub> = 2 V, R <sub>L</sub> = 350 $\Omega$ , T <sub>A</sub> = 25°C, V <sub>CM</sub> = 1000 V	9	10, 12
Output Low Level Common Mode Transient Immunity	CM <sub>L</sub>	ACPL-W60L ACPL-K63L	10	15	kV/ $\mu$ s	V <sub>CC</sub> = 5 V, I <sub>F</sub> = 7.5 mA, V <sub>O(MAX)</sub> = 0.8 V, R <sub>L</sub> = 350 $\Omega$ , T <sub>A</sub> = 25°C, V <sub>CM</sub> = 1000 V	9	11, 12

## Package Characteristics

All Typicals at  $T_A = 25^\circ\text{C}$ .

Parameter	Sym.	Package	Min.	Typ.	Max	Units	Test Conditions	Fig.	Note
Input-Output Insulation	$I_{I-O}^*$	Single			1	$\mu\text{A}$	45% RH, $t = 5\text{ s}$ , $V_{I-O} = 3\text{ kV DC}$ , $T_A = 25^\circ\text{C}$		13, 14
Input-Output Momentary Withstand Voltage*	$V_{ISO}$	Single, Dual Channel	5000			V rms	RH $\leq 50\%$ , $t = 1\text{ min}$ , $T_A = 25^\circ\text{C}$		13, 14
Input-Output Resistance	$R_{I-O}$	Single, Dual Channel		$10^{12}$		$\Omega$	$V_{I-O} = 500\text{ V dc}$		1, 13, 15
Input-Output Capacitance	$C_{I-O}$	Single, Dual Channel		0.5		pF	$f = 1\text{ MHz}$ , $T_A = 25^\circ\text{C}$		1, 13, 15
Input-Input Insulation Leakage Current	$I_{I-I}$	Dual Channel		0.005		$\mu\text{A}$	RH $\leq 45\%$ , $t = 5\text{ s}$ , $V_{I-I} = 500\text{ V}$		16
Resistance (Input-Input)	$R_{I-I}$	Dual Channel		$10^{11}$		$\Omega$			16
Capacitance (Input-Input)	$C_{I-I}$	Dual Channel		0.25		pG	$f = 1\text{ MHz}$		16

\*The Input-Output Momentary Withstand Voltage is a dielectric voltage rating that should not be interpreted as an input-output continuous voltage rating. For the continuous voltage rating refer to the IEC/EN/DIN EN 60747-5-2 Insulation Characteristics Table (if applicable), your equipment level safety specification or Avago Application Note 1074 entitled "Optocoupler Input-Output Endurance Voltage."

Notes:

- Each channel.
- Peaking circuits may produce transient input currents up to 50 mA, 50 ns maximum pulse width, provided average current does not exceed 20 mA.
- Peaking circuits may produce transient input currents up to 50 mA, 50 ns maximum pulse width, provided average current does not exceed 15 mA.
- Derate linearly above  $+80^\circ\text{C}$  free-air temperature at a rate of  $2.7\text{ mW}/^\circ\text{C}$ .
- Bypassing of the power supply line is required, with a  $0.1\ \mu\text{F}$  ceramic disc capacitor adjacent to each optocoupler as illustrated in Figure 11. Total lead length between both ends of the capacitor and the isolator pins should not exceed 20 mm.
- The  $t_{PLH}$  propagation delay is measured from the 3.75 mA point on the falling edge of the input pulse to the 1.5 V point on the rising edge of the output pulse.
- The  $t_{PHL}$  propagation delay is measured from the 3.75 mA point on the rising edge of the input pulse to the 1.5 V point on the falling edge of the output pulse.
- $t_{PSK}$  is equal to the worst case difference in  $t_{PHL}$  and/or  $t_{PLH}$  that will be seen between units at any given temperature and specified test conditions.
- See test circuit for measurement details.
- $CM_H$  is the maximum tolerable rate of rise on the common mode voltage to assure that the output will remain in a high logic state (i.e.,  $V_O > 2.0\text{ V}$ ).
- $CM_L$  is the maximum tolerable rate of fall of the common mode voltage to assure that the output will remain in a low logic state (i.e.,  $V_O < 0.8\text{ V}$ ).
- For sinusoidal voltages,  $(|dV_{CM}| / dt)_{\max} = \pi f_{CM} V_{CM} (p-p)$ .
- Single channel device is considered a two-terminal part when pins 1, 2, 3 are shorted together, and pins 4, 5, 6 shorted together separately. Dual channel device is considered a two-terminal part when pins 1, 2, 3, 4 are shorted together, and pins 5, 6, 7, 8 are shorted together separately.
- In accordance with UL 1577, each optocoupler is proof tested by applying an insulation test voltage  $\geq 6000\text{ V rms}$  for one second (leakage detection current limit,  $I_{I-O} \leq 5\ \mu\text{A}$ ). This test is performed before the 100% production test for partial discharge (Method b) shown in the IEC/EN/DIN EN 60747-5-2 Insulation Characteristics Table, if applicable.
- Measured between the LED anode and cathode shorted together and pins 5 through 8 shorted together. For dual channel products only.
- Measured between pins 1 and 2 shorted together, and pins 3 and 4 shorted together. For dual channel products only.

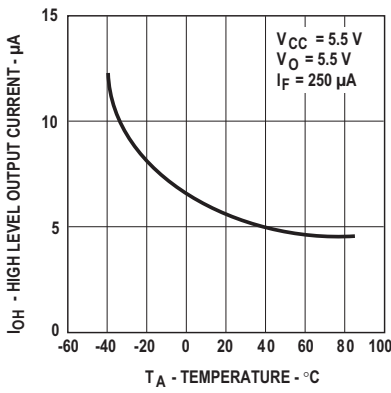
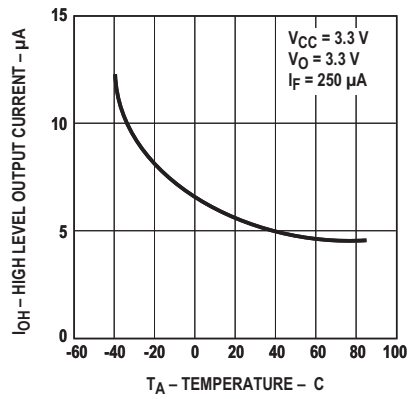

Figure 1. Typical high level output current vs. temperature.

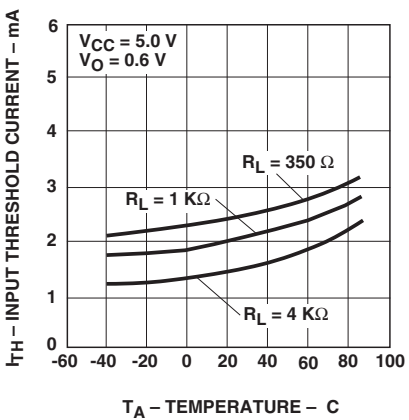
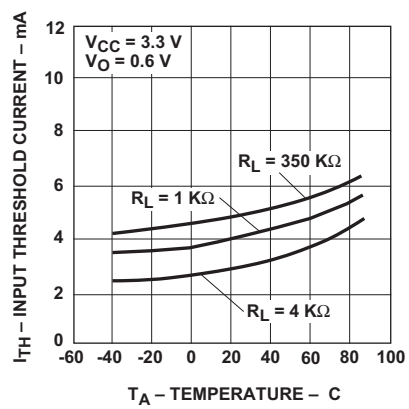

Figure 2. Typical input threshold current vs. temperature.

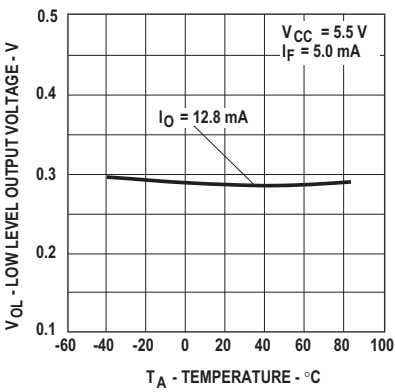
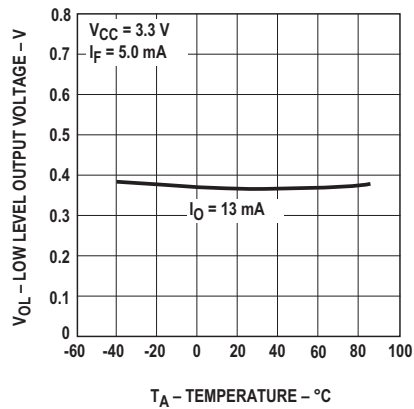

Figure 3. Typical low level output voltage vs. temperature.

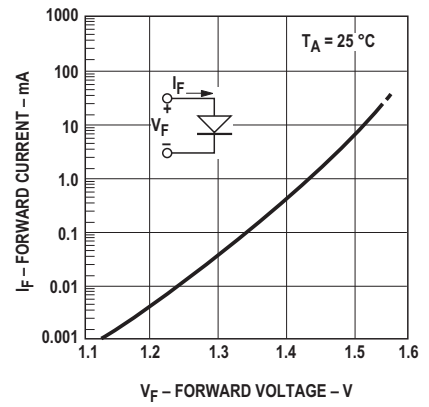
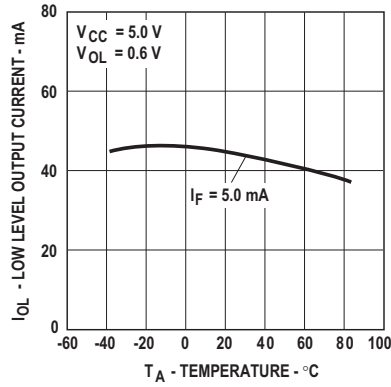
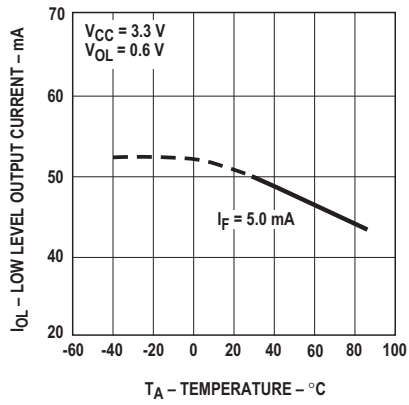
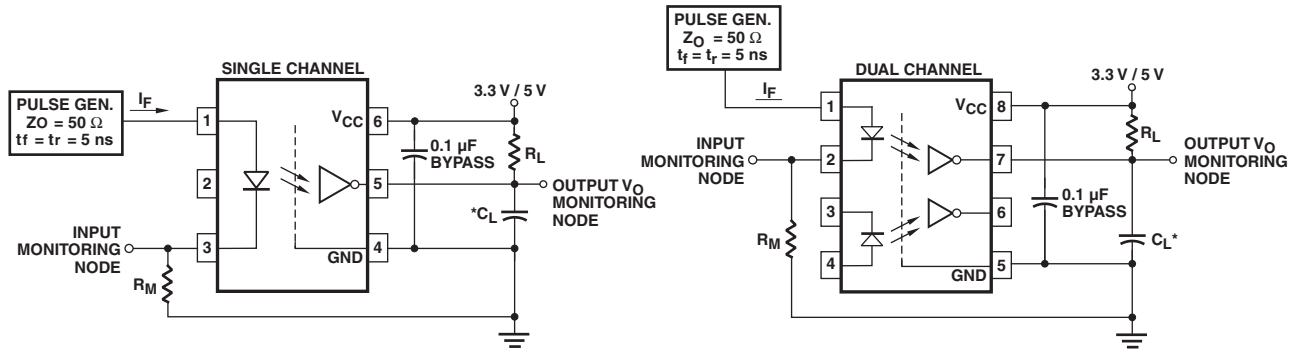

Figure 4. Typical low level output current vs. temperature.

Figure 5. Typical input diode forward characteristic.



\* $C_L$  IS APPROXIMATELY 15 pF WHICH INCLUDES PROBE AND STRAY WIRING CAPACITANCE.

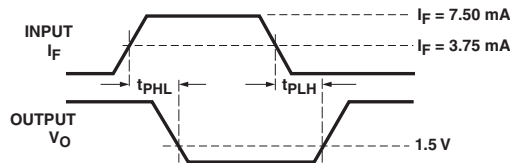

Figure 6. Test circuit for  $t_{PHL}$  and  $t_{PLH}$ .

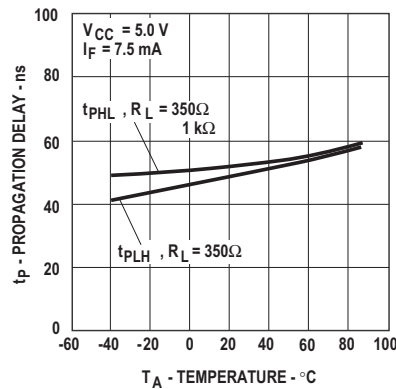
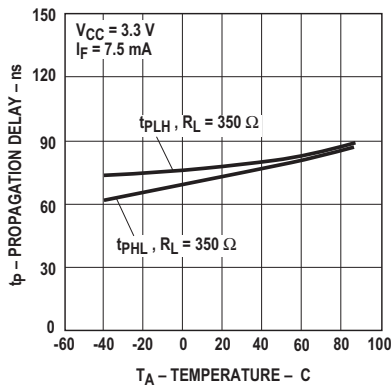

Figure 7. Typical propagation delay vs. temperature.

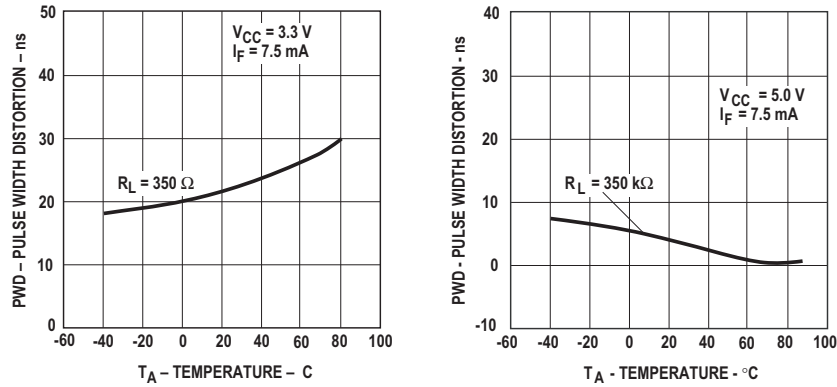

Figure 8. Typical pulse width distortion vs. temperature.

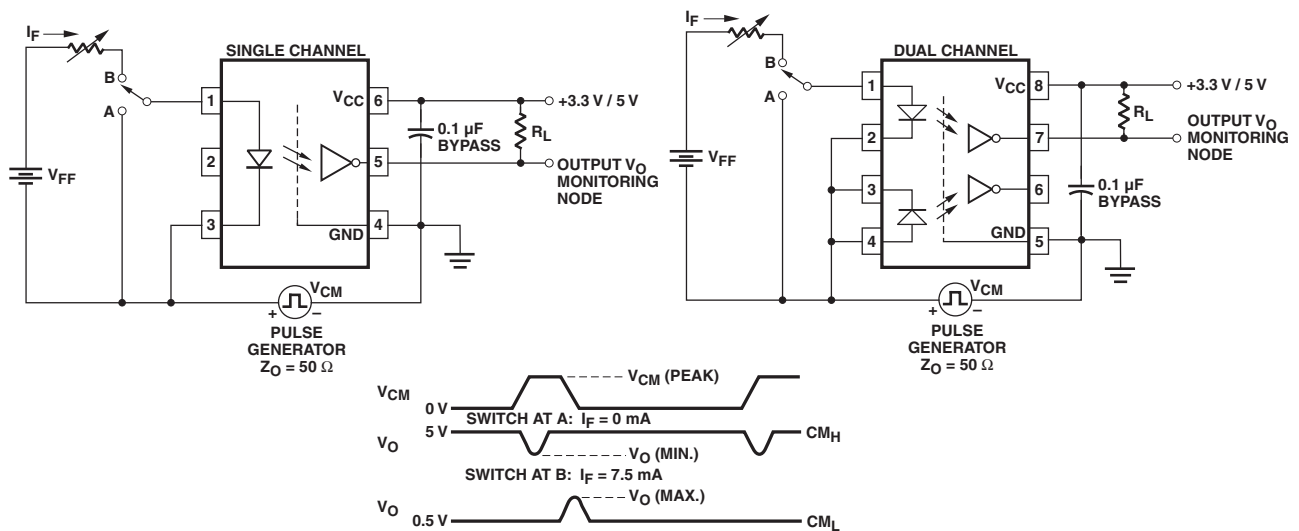

Figure 9. Test circuit for common mode transient immunity and typical waveforms.

For product information and a complete list of distributors, please go to our web site: [www.avagotech.com](http://www.avagotech.com)

Avago, Avago Technologies, and the A logo are trademarks of Avago Technologies in the United States and other countries. Data subject to change. Copyright © 2005-2010 Avago Technologies. All rights reserved. Obsoletes AV01-0206EN AV02-0890EN - April 8, 2010

**AVAGO**  
TECHNOLOGIES