

1

2

3

4

5

6

A

B

C

D

E

F

A

B

C

D

E

F

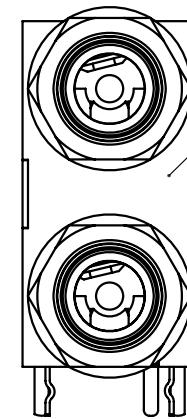
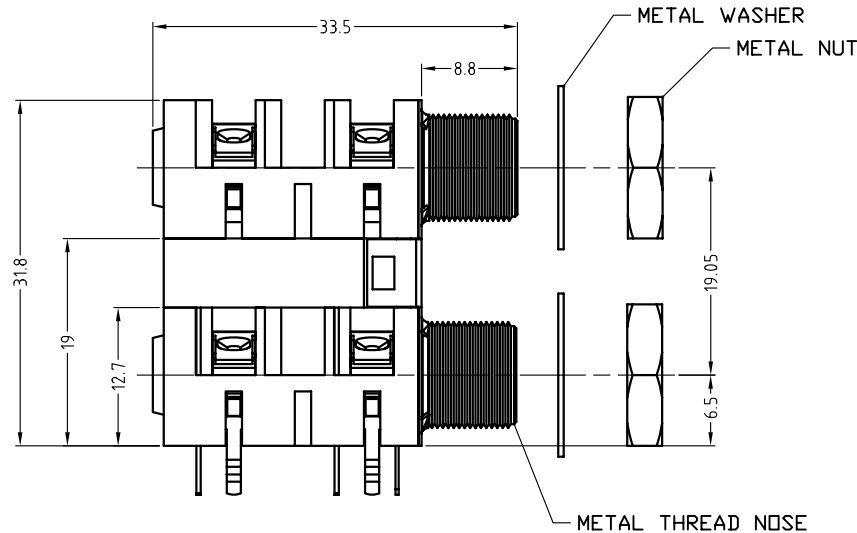
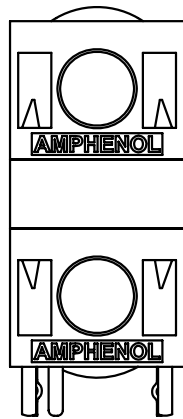

RFI SCREEN

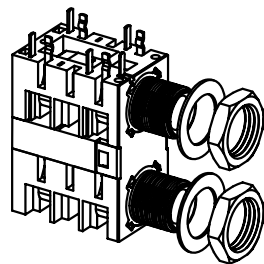

ISO VIEW  
SCALE 1:1

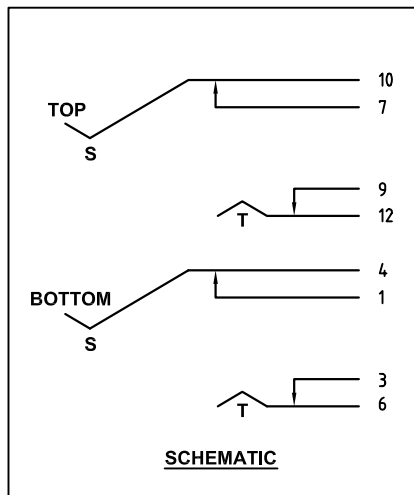

SCHEMATIC

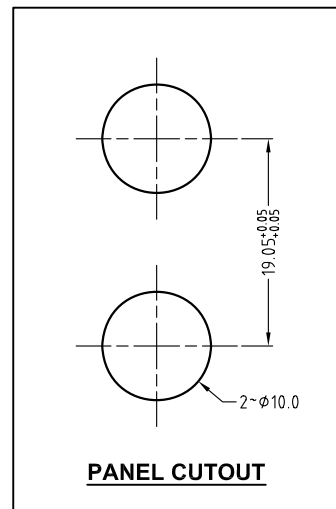

PANEL CUTOUT

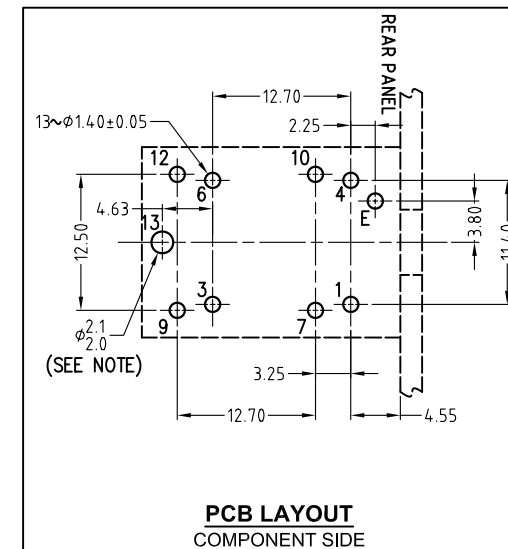

PCB LAYOUT  
COMPONENT SIDE

NOTE: OPTIONAL MOUNTING HOLE FOR SELF-TAPPING M2 SCREW

CATALOGUE P/N	NUT OPTION
ACJM-LHDEM	NO NUT & WASHER
ACJM-MHDEM	METAL NUT & WASHER INCLUDED

UNLESS OTHERWISE SPECIFIED TOLERANCE TO BE		THIS DOCUMENT IS THE PROPERTY OF AMPHENOL AUSTRALIA PTY. LTD. NO PART THEREOF MAY BE REPRODUCED AND USED WITHOUT THE PRIOR WRITTEN CONSENT OF THE OWNER				0	FIRST ISSUE	M.H	17-06-09	----
LINEAR	ANGULAR					REV.	CHANGE DETAILS	BY	DATE	CHG/No
X ± 0.5	X° ± 1°	CAD FILE:	55010600001120	DRN:	M.H	DATE:	17-06-09	TITLE:		
X.X ± 0.20	X°X' ± 30'	MATERIAL: REFER TO COMPONENT		CKD:	M.H	DATE:	17-06-09	1/4" PHONE MONO DUAL JACK CUSTOMER DRAWING		
X.XX ± 0.10	X°X'X" ± 15"	DO NOT SCALE		FINISH: REFER TO COMPONENT	APP'D:	P.M	DATE:	17-06-09	DRAWING NO. SHEET	
DIMENSIONS IN MILLIMETRES		THIRD ANGLE PROJECTION		SCALE:	2:1 UDS	PART No:	SEE TABLE	SIZE:	A3	55010600-001-2 2 OF 2

**Amphenol**

Amphenol Australia Pty.Ltd, 2 Fireweys Blvd, Keysborough, Vic3173

DRAWING NO. SHEET

55010600-001-2 2 OF 2