

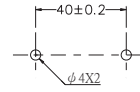

ANLY ACCESSORY

DIMENSION(mm)

8PFA

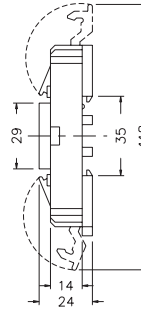
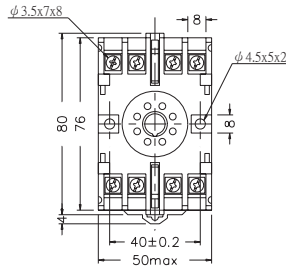

PF085A

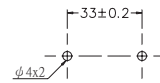
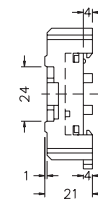
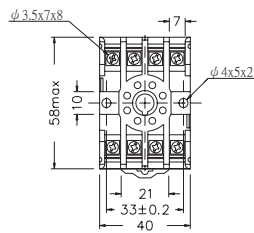

PF083A

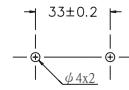
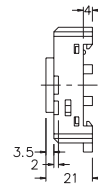
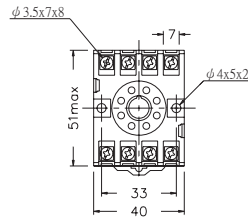

PF083A-E

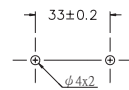
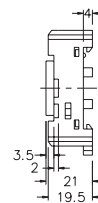
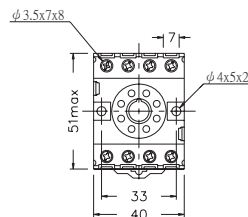

P2CF-08

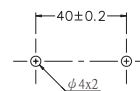
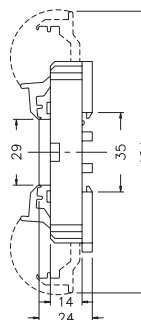
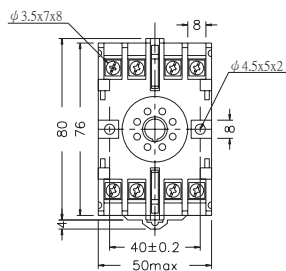

ANLY

DIMENSION(mm)

PF113A

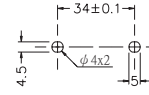
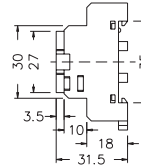
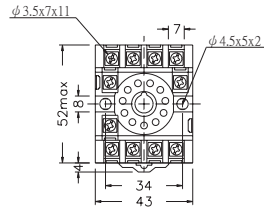

PF113A-E

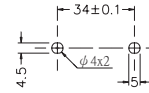
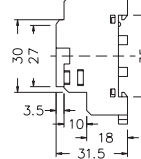
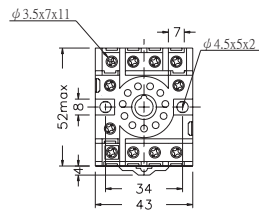

P3G-08

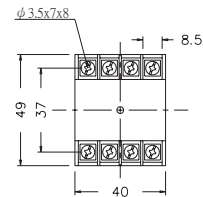
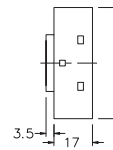
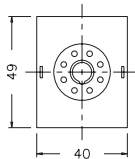

US-08

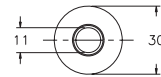
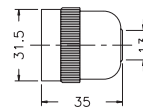
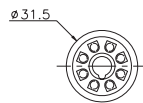

PYF08A

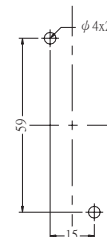
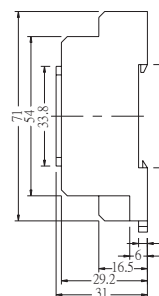
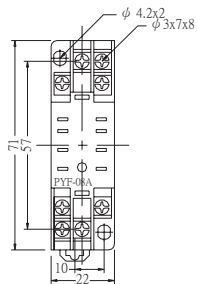

DIMENSION(mm)

PYF08A-E

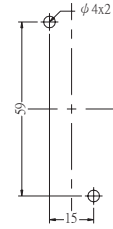
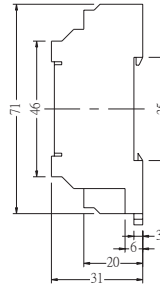
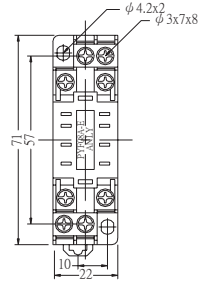

PYF14A

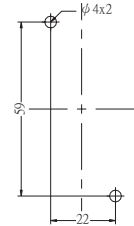
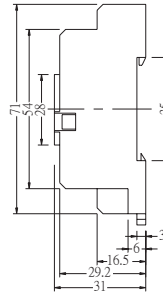
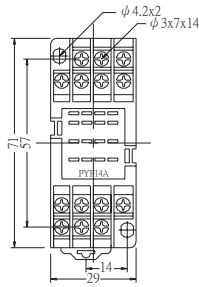

PYF14A-E

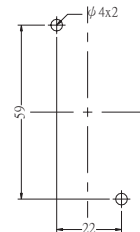
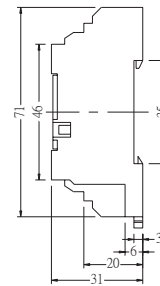
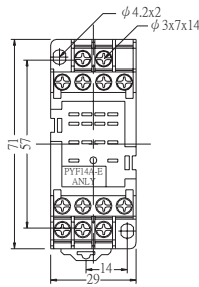

PTF08A

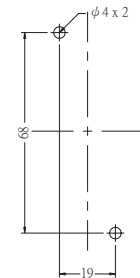
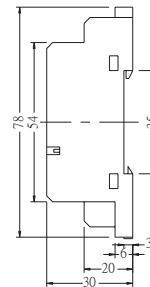
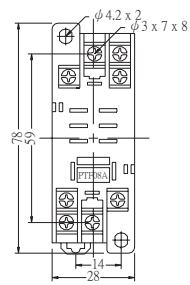

PTF08A-E

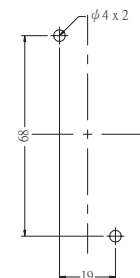
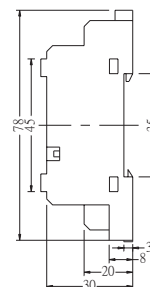
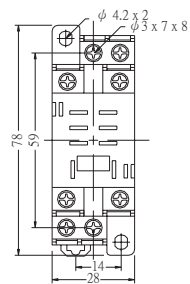

DIMENSION(mm)

APS-3

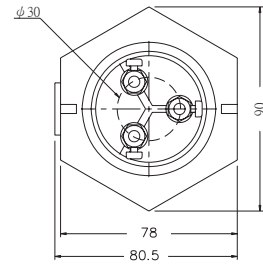
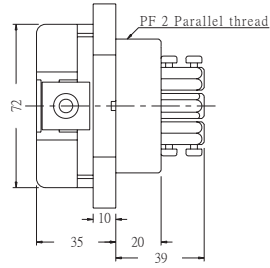

PS-3S, PS-4S, PS-5S

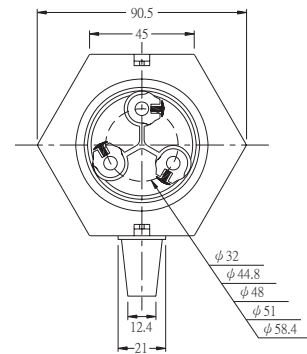
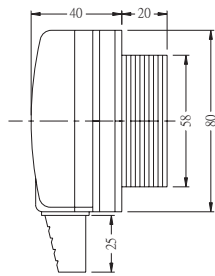

AF-12

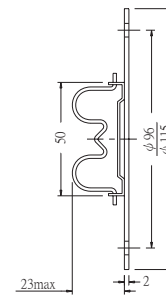
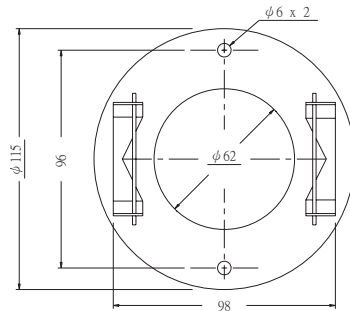

STAINLESS

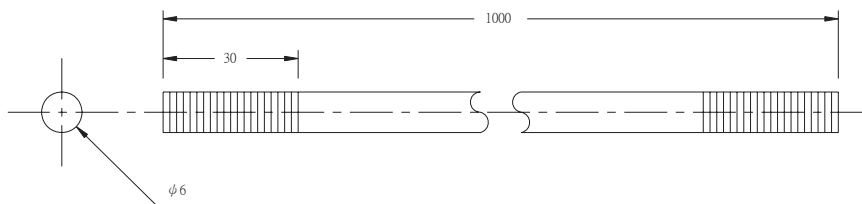

SUSQ

CONNECTING NUT

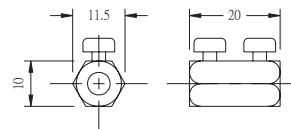
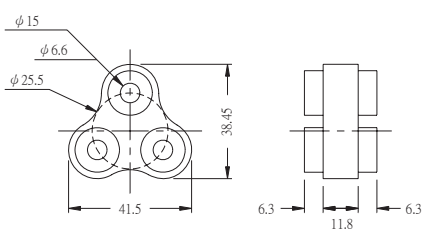

DIMENSION(mm)

Y-20

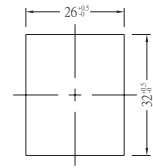
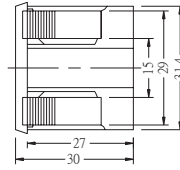
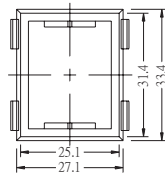

Y-30



$\phi 5.9$
 $\phi 4.5$
 $\phi 2.5$

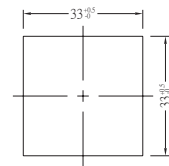
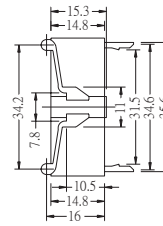
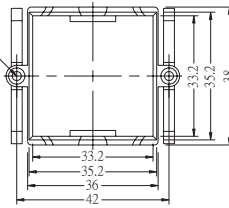

Y-40

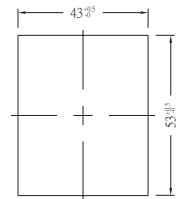
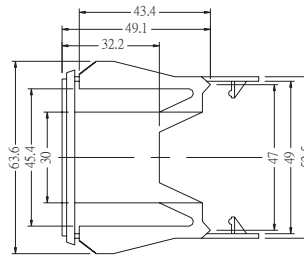
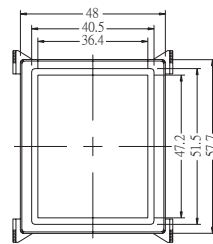

Y-50

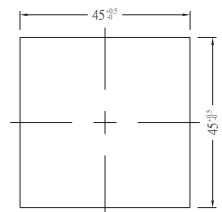
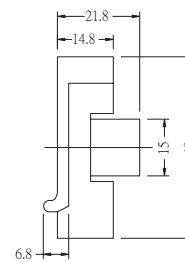
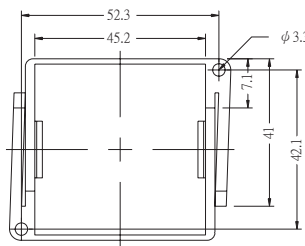
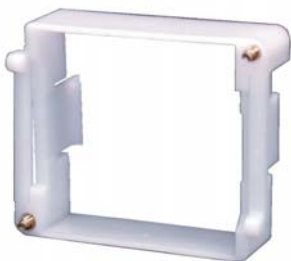

Y-57

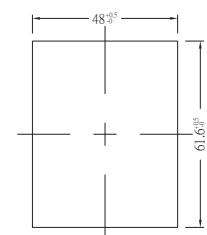
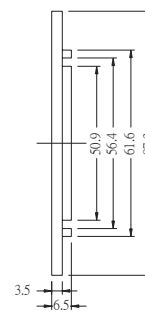
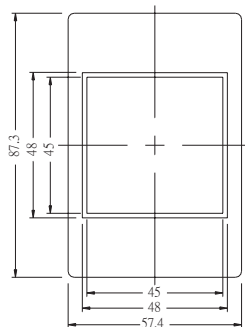

DIMENSION(mm)

Y-70

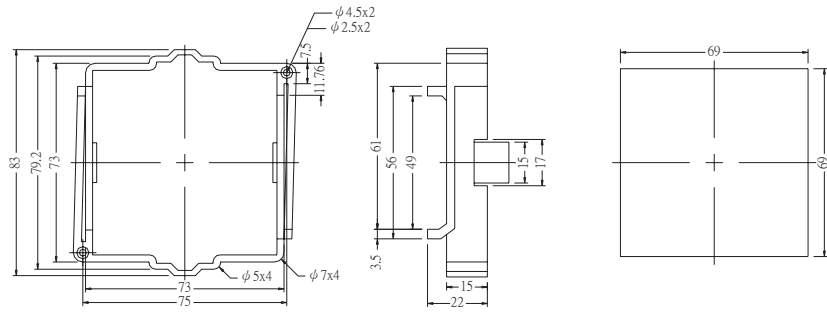

DUST COVER - ASY SERIES

DUST COVER - AH5 SERIES

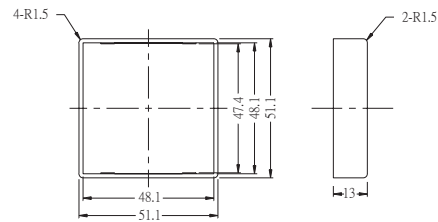
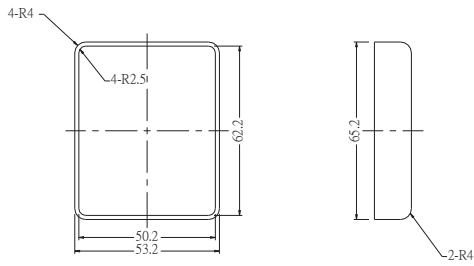

AL-100

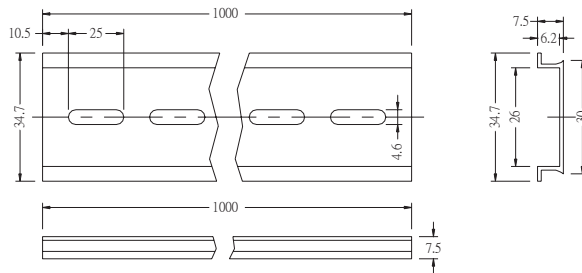

FM-2

FM-4

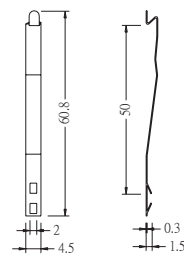
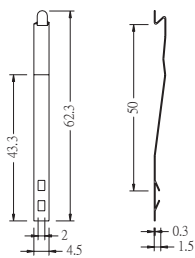

FY-2

FG-3

FH-3

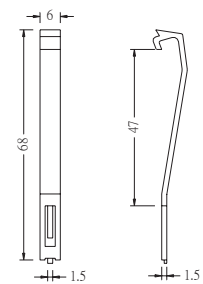
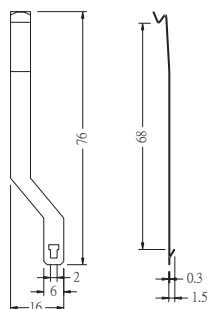
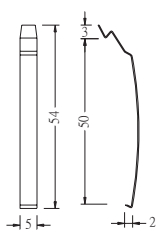

DIMENSION(mm)

SUSQ-5

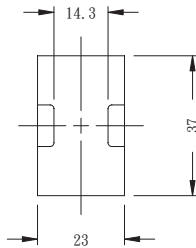
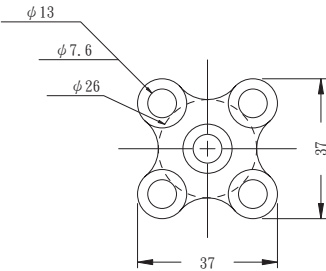

PF-083BE

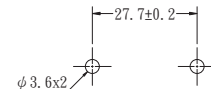
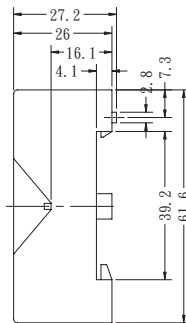
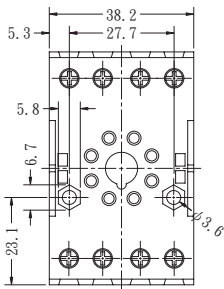

PF-113BE

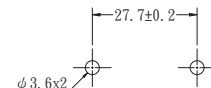
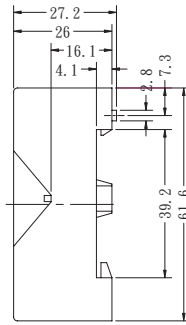
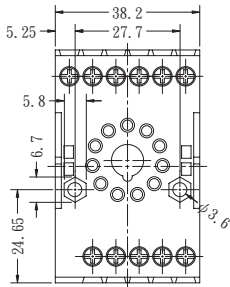

ONLY