

## A64-OLinuXino

64-bit open source embedded computer

# QUICK START GUIDE

Document revision C, February 2019  
Designed and manufactured by OLIMEX Ltd, 2017



All boards manufactured by OLIMEX LTD are RoHS compliant

A64-OLinuXino is a single-board open hardware computer. It is a system built on a single circuit board with all hardware for proper operation already available (such as processor, power management unit, memories, peripherals, connectors, and everything else required for basic operation).

On the other hand, A64-OLinuXino can also be considered a general-purpose development board. It can be used in an infinite number of ways. It can boot different operating systems and distributions. There are a number of options for accessing the operating system. The platform has free general purpose pins and popular hardware interfaces. The board allows different ways of powering. This guide doesn't cover all possible ways to setup the board – it lists the two most typical ways of accessing the board for the first time. The guide is intended for absolute beginners.

## 1. First time setup with HDMI display

---

This method might be suitable for people that lack USB ↔ serial cable but have HDMI display. It is also a method that shows the graphical user interface of the operating system. This method is prone to software issues and incompatibilities. Additional access to the board via USB ↔ serial cable is highly recommended, skip to chapter “2. First time setup with USB ↔ serial cable” if you need more details on how to set that up.

### 1.1. Items required

---

Before you proceed ensure that you have the following items at your disposal:

**1.1.1. A board.** Any version of the A64-OLinuXino board.

**1.1.2. Power supply.** An external source of power supply. It should be capable of providing at least 1A of current at 5V of voltage. If you power additional components from the board (e.g. USB modem, LCD display, keyboard, mouse, etc.) consider a power supply capable of providing at least 2A of current. The power supply should fit the on-board power jack.

*The on-board DC barrel jack is center positive and the inner pin is 2.0mm thick. The outer hole diameter is 6.3mm. The corresponding power supply plug (or female jack) that fits the DC barrel jack has 2.1mm inner diameter and 5.5mm outer diameter. The length of the male plug should be between 10mm and 14mm.*

*For basic operation consider the 5V power adapters that we distribute – SY0605E and SY0605E-CHINA (note that you might need additional plug adapter if you live outside of mainland Europe).*

**IMPORTANT! The A64-OLinuXino board is fully powered by applying 5V of voltage over the power jack connector named “PWR1”. The board can also be powered by a 3.7V Li-Po battery attached to the “LIPO\_BAT1” connector (there is a step-up convertor to 5V, so the USB ports would still work, albeit with lower current output available). For people that want to embed the board in their own designs and find using power jack “PWR1” inconvenient, please use the pad of “FUSE2” to provide power supply (and any on-board “GND” wire or pad – good places for GND are pad #2 from “UEXT1” or pad #2 from “GPIO1” or the GND pad of the “HSIC1”).**

The A64-OLinuXino board **CAN NOT** and **SHOULD NOT** be powered via the micro USB connector “USB-OTG1”, nor via type A female USB connector “USB1”, nor via any of the “GPIO1” pads, nor via the “UEXT1” pads, nor via Ethernet connector “LAN1”, nor via “HDMI1” connector, nor via “HSIC1” pads, nor via nor “IPS1” pad, etc. Some of the pins of the mentioned connectors and interfaces might have wires, pads, or pins marked as “+3.3V” or “+5V” in the schematics or in the board design files but these are outputs only and **NOT** power inputs.

**1.1.3. MicroSD card with image.** A micro SD card card with an official image provided by Olimex suitable for your board. You can use own micro SD card – we provide download links to the official images at the product page and the board's wiki article. The card has to be at least 8GB of size. In this case you would need a card writer tool to prepare the card and a personal computer with Internet access that is capable of running a torrent client freely.

Link to the product page, latest official images are available in the “SOFTWARE” paragraph:  
<https://www.olimex.com/Products/OLinXino/A64/A64-OLinXino/open-source-hardware>

We distribute affordable blank microSD cards here:

<https://www.olimex.com/Products/Components/Storage/MICRO-SD-8GB-CLASS10/>

**1.1.4. Monitor.** A monitor or display with native HDMI interface, capable of 1280×720 resolution (or marked as “HD ready” or “720p”).

**1.1.5. HDMI cable.** An HDMI cable compatible with the board and the monitor.

**1.1.6. Input peripherals.** Like a keyboard and a mouse. Note that the board has only one USB type A host connector exposed and only one USB micro connector exposed – you will either need specific keyboard + mouse hardware (that uses only one USB host port), or specific adapter cable (to fit the USB micro connector), or an external USB hub (USB splitter).

## 1.2. Preparation and boot

Once we have everything required we can proceed booting:

**1.2.1.** Carefully open the box with the board. The box contains only the board in protective packaging and four (4) rubber feet.

**1.2.2.** Remove the board from the protective packaging and place the four rubber feet at bottom of the board. Use the four mounting holes. If you have trouble inserting them straight, try pushing and rotating the rubber. Some surfaces might use conductive materials and placing the board directly over such a surface might lead to short-circuit. The rubber feet allow the board to be placed safely on a flat surface without the risk of short-circuit. Here is a picture of A64-OLinXino-1G4GW with the four rubber feet properly placed at the bottom and important parts labeled:

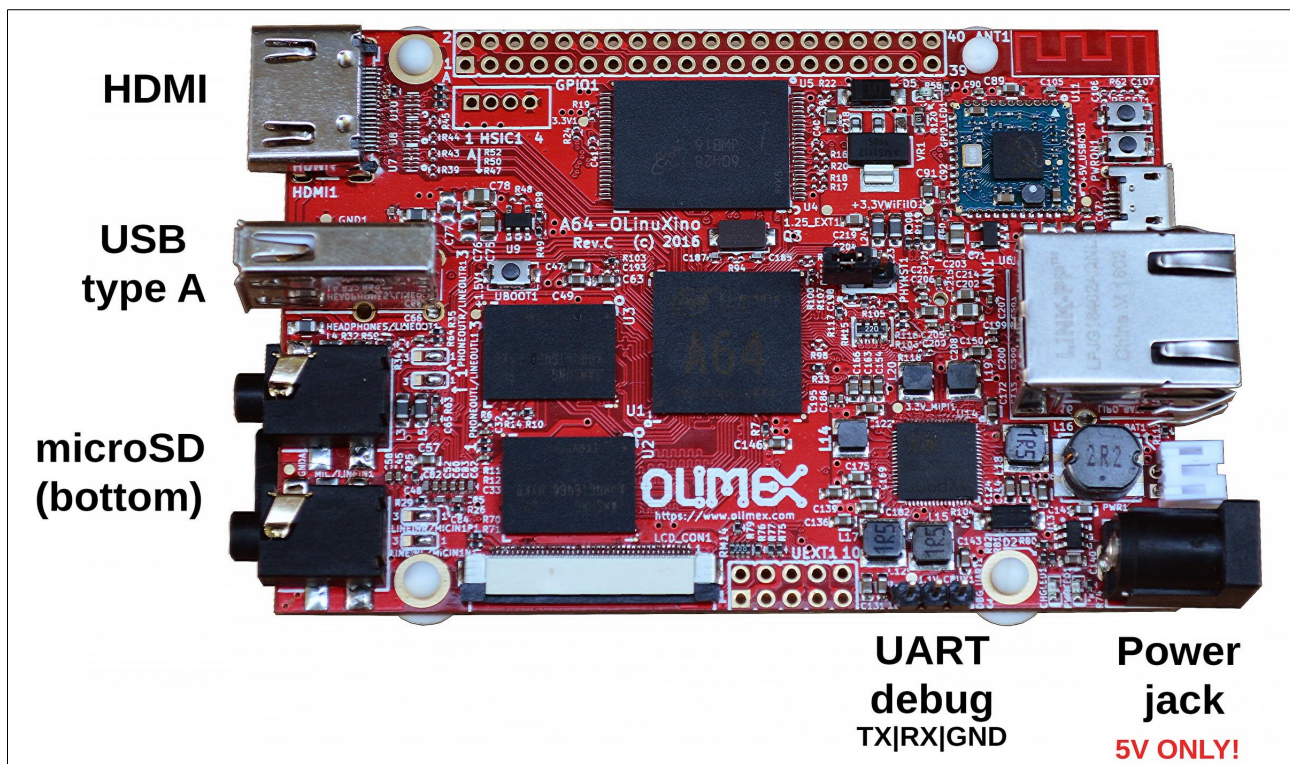

**1.2.3.** Download the archive with the latest official image from the board's web-page to your computer. Extract the archive and download the image to the microSD card via the microSD card reader/writer. Make sure to back-up any files located on the microSD card since download the image to it, would destroy any data. There are a lot of software tools that can be used for downloading the image to the card. If you have no experience under Windows use “Win32 Disk Imager” tool – point to the image and select the drive associated with the card, then click Write. Refer to the picture:

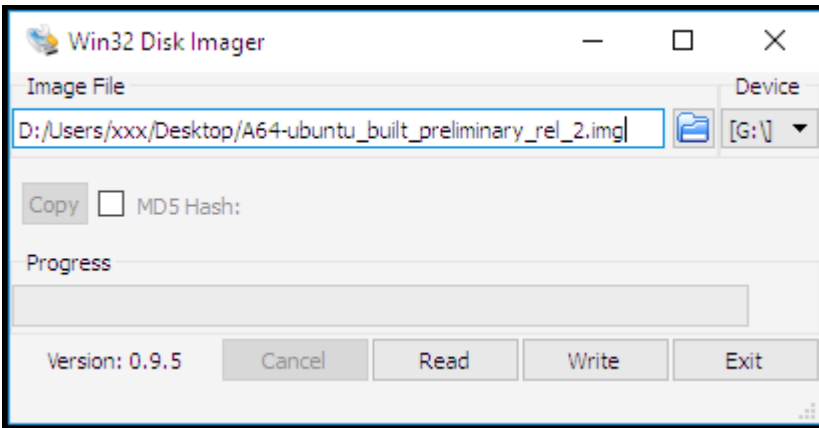

**1.2.4.** Connect the input and output peripherals to the board. Insert the microSD card. Connect display to the HDMI of the board. Connect the keyboard and the mouse to the USB ports. Connect LAN cable if you have available. Do not connect the power supply until rest of the hardware had been already connected. The general layout that we aim for is listed below:

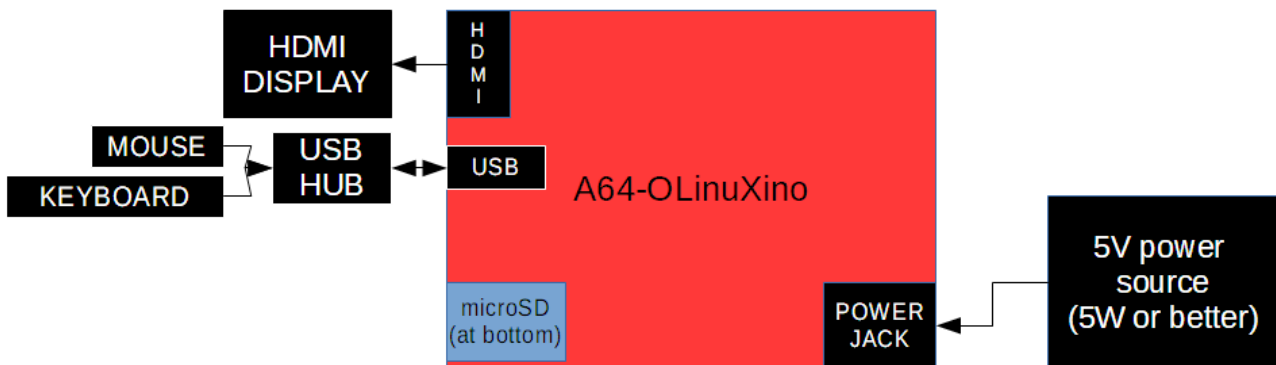

**1.2.5** Power the display and apply the power supply to the board. The graphical user interface should start automatically. By default the super user name is “root” the password is “olimex”.



---

## 2. First time setup with USB ↔ serial cable

---

This is the most direct and recommended method of accessing the board. It allows you to access the command line interface of the Linux operating system of the A64 board via your personal computer. Some server Linux images might lack video output capabilities at all and using a USB-serial cable would be one of the ways to access the board.

This method is used to execute the video selection script.

### 2.1. Items required

---

Before you proceed ensure that you have the items listed in this chapter available:

**2.1.1. A board.** Any version of the A64-OLinuXino board.

**2.1.2. Power supply.** An external source of power supply. It should be capable of providing at least 1A of current at 5V of voltage. If you power additional components from the board (e.g. USB modem, LCD display, keyboard, mouse, etc.) consider a power supply capable of providing at least 2A of current. The power supply should fit the on-board power jack.

*The on-board DC barrel jack is center positive and the inner pin is 2.0mm thick. The outer hole diameter is 6.3mm. The corresponding power supply plug (or female jack) that fits the DC barrel jack has 2.1mm inner diameter and 5.5mm outer diameter. The length of the male plug should be between 10mm and 14mm.*

*For basic operation consider the 5V power adapters that we distribute – SY0605E and SY0605E-CHINA (note that you might need additional plug adapter if you live outside of mainland Europe)*

**IMPORTANT!** The A64-OLinuXino board is fully powered by applying 5V of voltage over the power jack connector named “PWR1”. The board can also be powered by a 3.7V Li-Po battery attached to the “LIPO\_BAT1” connector (there is a step-up convertor to 5V, so the USB ports would still work, albeit the output current available would be limited). For people that want to embed the board in their own designs and find using power jack “PWR1” inconvenient, please use the pad of “FUSE2” to provide power supply (and any on-board “GND” wire or pad – good places for GND are pad #2 from “UEXT1” or pad #2 from “GPIO1”).

The A64-OLinuXino board **CAN NOT** and **SHOULD NOT** be powered via the micro USB connector “USB-OTG1”, nor via type A female USB connector “USB1”, nor via any of the “GPIO1” pads, nor via the “UEXT1” pads, nor via Ethernet connector “LAN1”, nor via “HDMI1” connector, nor via “HSIC1” pads, nor via nor “IPS1” pad, etc. Some of the pins of the mentioned connectors and interfaces might have wires, pads, or pins marked as “+3.3V” or “+5V” in the schematics or in the board design files but these are outputs only and **NOT** power inputs.

**2.1.3. A personal computer with serial terminal software installed.** *This guide gives information about the usage of a USB ↔ serial cable and terminal software only under Windows; users of other operating systems can get familiar with serial terminal software and its usage via a quick internet search (it is a very well known process).*

**2.1.4. USB-serial converter cable.** A USB ↔ serial cable with female leads with connectors for RX, TX, and GND. The cable and its drivers should be compatible with your personal computer. The cable should work at 3.3V (not 5V).

*These adapter cables are not expensive. Such a cable can be purchased from almost any electronics store and online. We also manufacture a CH340T-based cable available here:*

*<https://www.olimex.com/Products/Breadboarding/BB-CH340T/open-source-hardware> and also we distribute PL2303XA-based cable, available here: <https://www.olimex.com/Products/Components/Cables/USB-Serial-Cable/USB-Serial-Cable-F/>*

**2.1.5. MicroSD card with image.** A micro SD card card with an official image provided by Olimex suitable for your board. You can use own micro SD card – we provide download links to the official images at the product page and the board's wiki article. The card has to be at least 8GB of size. In this case you would need a card writer tool, in order to prepare the card and a personal computer with Internet access that is capable of running a torrent client freely, in order to download our official images.

Link to the product page, latest official images are available in the “SOFTWARE” paragraph:  
<https://www.olimex.com/Products/OLinUxino/A64/A64-OLinUxino/open-source-hardware>

We distribute affordable blank microSD cards here:

<https://www.olimex.com/Products/Components/Storage/MICRO-SD-8GB-CLASS10/>

## 2.2. Preparation and boot

Once we have everything require we can proceed booting:

**2.2.1.** Carefully open the box with the board. The box contains only the board in protective packaging and four (4) rubber feet.

**2.2.2.** Remove the board from the protective packaging and place the four rubber feet at bottom of the board. Use the four mounting holes. If you have trouble inserting them straight, try pushing and rotating the rubber. Some surfaces might use conductive materials and placing the board directly over such a surface might lead to short-circuit. The rubber feet allow the board to be placed safely on a flat surface without the risk of short-circuit. Here is a picture of A64-OLinUxino-1G4GW with the four rubber feet properly placed at the bottom and important parts labeled:

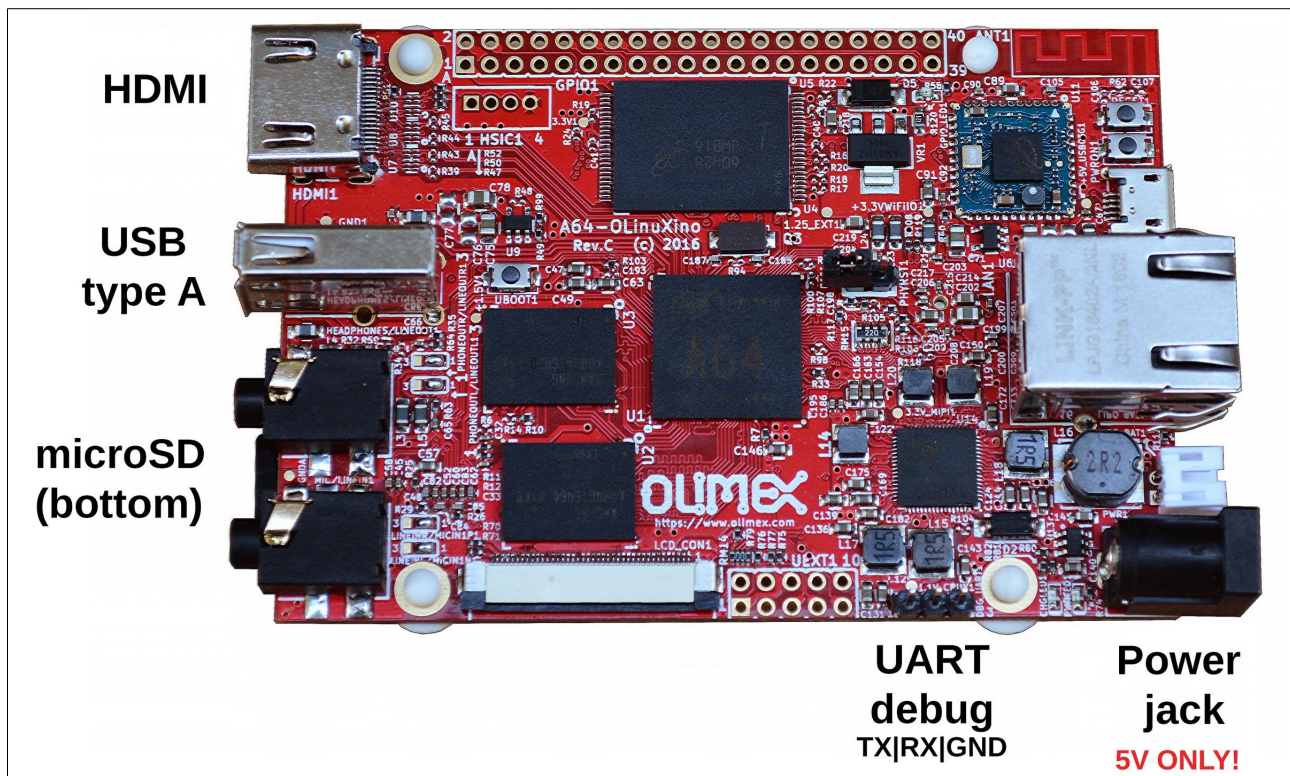

**2.2.3.** Download the archive with the latest official image from the board's web-page to your computer. Extract the archive and download the image to the microSD card via the microSD card reader/writer. Make sure to back-up any files located on the microSD card since downloading the image would destroy any previous data. *There are a lot of software tools that can be used for downloading the image to the card. If you have no experience under Windows use either "Win32 Disk Imager" tool or "Ethcher" – point to the image and select the drive associated with the card, then click Write. IMPORTANT! After the write is nearing completion, a prompt to format the card might appear, ignore it! This happens under Windows because the card ends up formatted in*

**2.2.4.** Insert the already prepared microSD card in the slot at the bottom of the board. *It is a push-push MicroSD connector. If you want to remove the card, do not pull it out directly – first push to release the locking mechanism and then remove it.*

**2.2.5.** Connect the USB-serial cable between your computer and the board. At the board's side use the three male pins behind the power jack – this is called the "UART debug" connector. Refer to the picture with the layout of the board on where "UART debug" is located. Connect cable's RX to the TX of the connector; cable's TX to the RX of the connector; GND of the cable to GND of the connector. Install the drivers for your USB-serial cable if you haven't already. Make sure it is properly recognized by your personal computer – it should be listed as a serial port (COMx; TTYx; etc).

**2.2.6.** Do not connect the power supply until rest of the hardware had been connected. The general layout that we aim for is listed below:

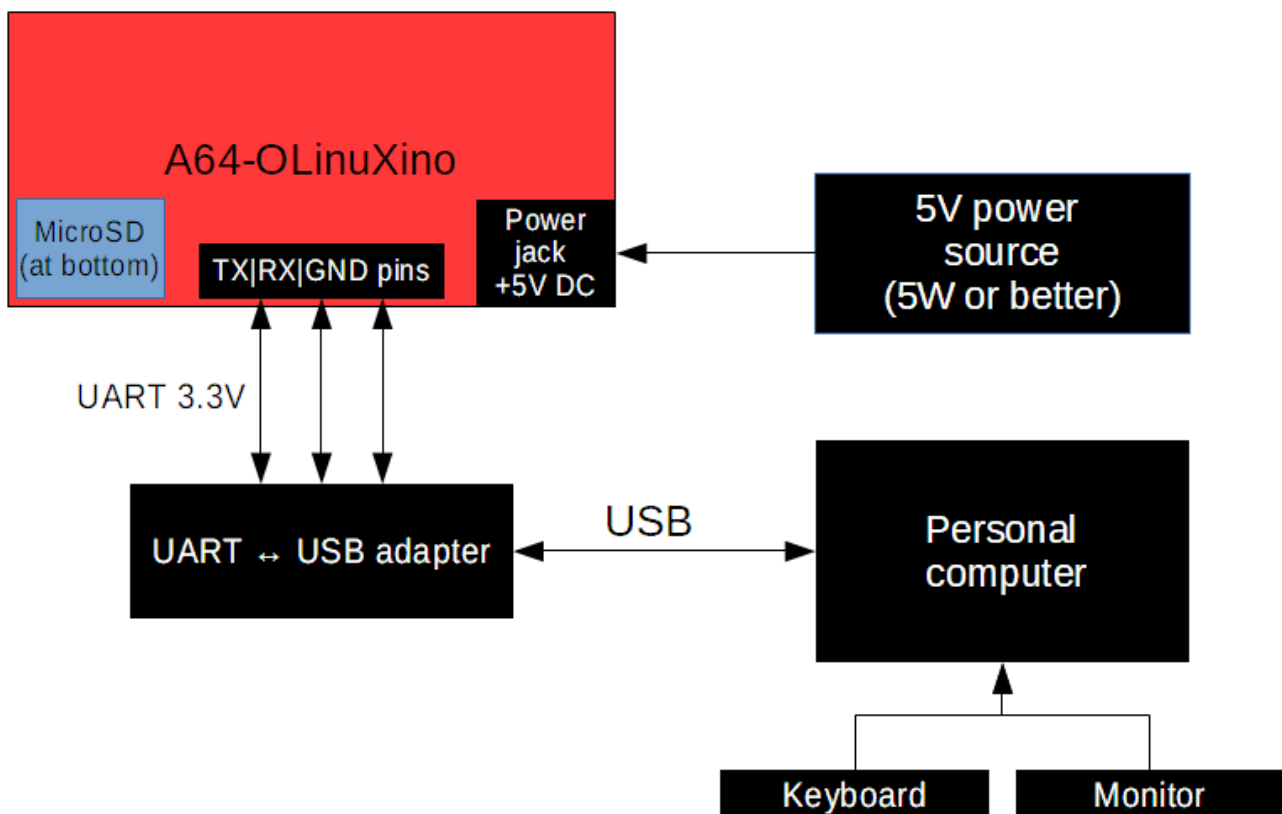

**2.2.7.** Start the terminal software. If you don't have such installed, download and install such for free, few popular free options are PuTTY, TeraTerm, RealTerm. *In some operating system there is serial terminal software already installed, installing additional serial terminal software might be redundant.* In this guide we use PuTTY and Windows 10. The cable used is Olimex BB-CH340. The first picture on the next page shows how the serial cable gets recognized by Windows once the drivers are properly installed:

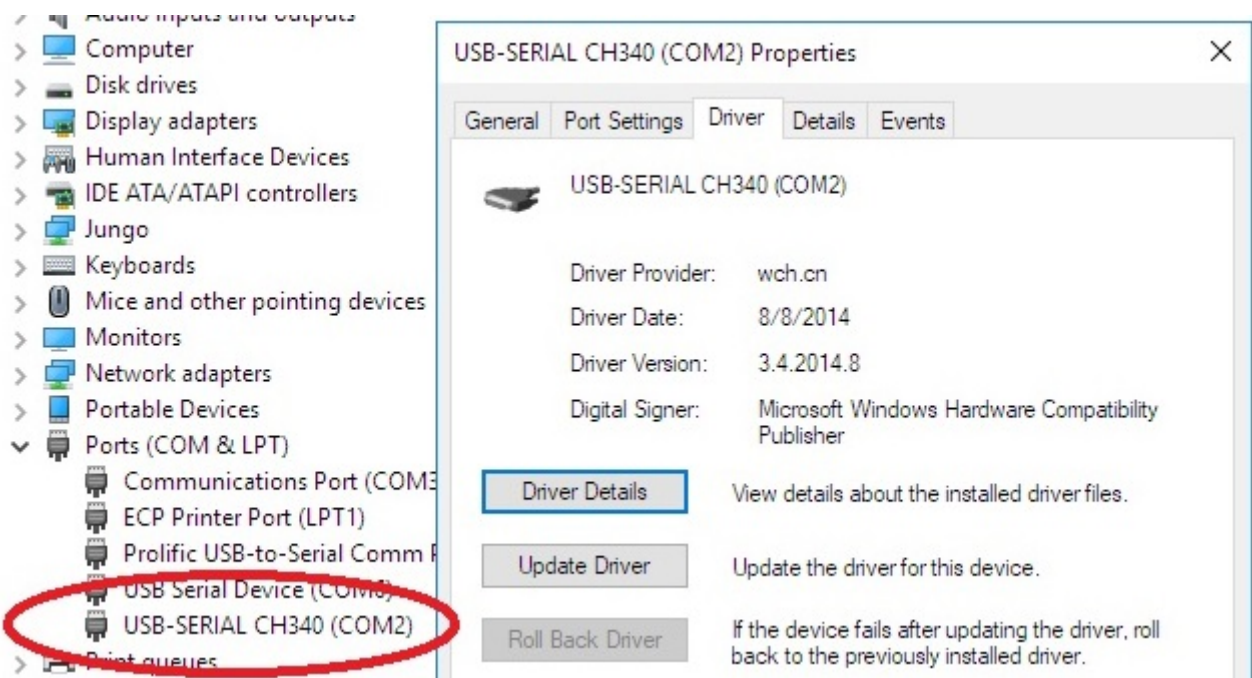

The serial cable that we use gets assigned COM #2. We need this information in order to start the PuTTY on the same serial port. Start your serial terminal software. PuTTY is shown below – select the proper COM port, the speed, make sure that the connection is set to “Serial” and finally click “Open” at the bottom:

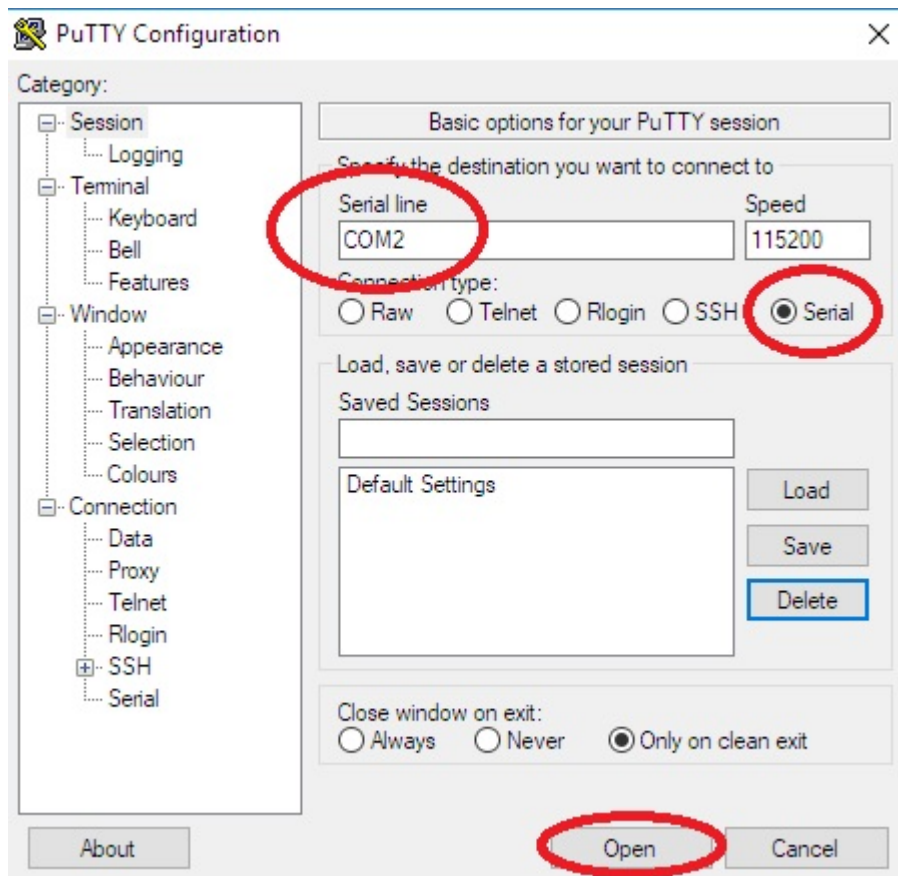

This would bring a black empty window, which would be our command interface to the board once we power the board.



**2.2.8.** Apply the power supply to the board. The on-board power LED At this point the PuTTY terminal should report boot data information from the board, and eventually we would be requested to provide super user credentials. The user name is "root" and the password is "olimex".

*If nothing shows up in the terminal quite likely RX and TX lines of the cable are swapped. Try to change RX and TX. Refer to the pictures and diagrams further up in this document.*