

Technical Data Sheet

High performance SMD LED with Reflector

93-22/G6R7C-B01/2A0

Features

- Package in 12mm tape on 7" diameter reels.
- Compatible with automatic placement equipment.
- Compatible with infrared and vapor phase reflow solder process.
- EIA std. package.
- IC compatible.
- Pb-free.
- The product itself will remain within RoHS compliant version.



Applications

- Telecommunication: indicator and backlighting in telephone and fax.
- Indicator and backlight for audio and video equipment.
- Indicator and backlight for battery driven equipment.
- Small indicator for outdoor applications.
- Indicator and backlight in office equipment.
- Flat backlight for LED, switches and symbol.
- General use.

Device Selection Guide

Chip			Lens Color
Type	Material	Emitted Color	
G6	AlGaInP	Brilliant Yellow Green	Water Clear
R7	AlGaInP	Dark-Red	

Package Dimensions

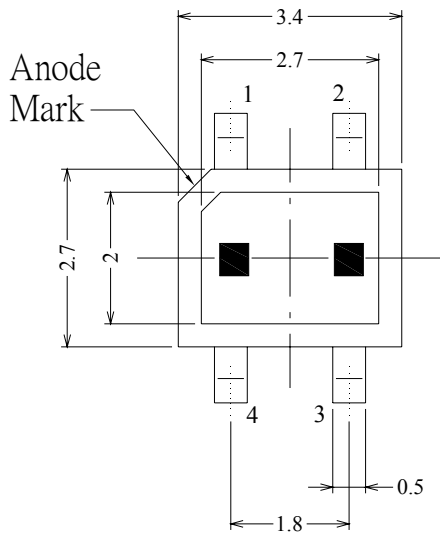
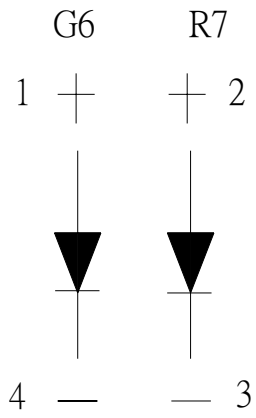
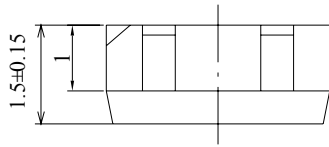

Polarity

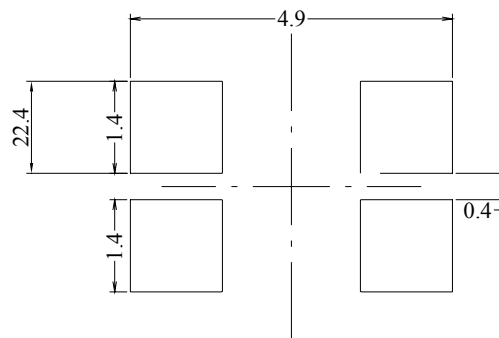
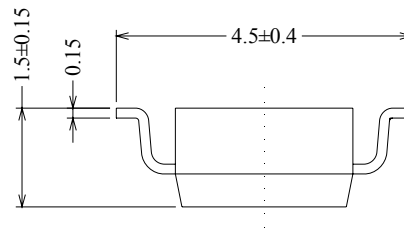

Recommended Soldering Pad design.

Note: The tolerances unless mentioned is $\pm 0.1\text{mm}$;Unit = mm

Absolute Maximum Ratings @Ta=25°C

Parameter	Symbol		Rating	Unit
Reverse Voltage	V _R		5	V
Forward Current	I _F	G6	25	mA
		R7		
Forward Current (Duty 1/10 @ 1KHz)	I _{FP}	G6	60	mA
		R7		
Power Dissipation Peak	P _d	G6	60	mW
		R7		
Electrostatic Discharge(HBM)	ESD		2000	V
Operating Temperature	T _{opr}		-40 ~ +85	°C
Storage Temperature	T _{stg}		-40~ +90	°C
Soldering Temperature	T _{sol}		Reflow Soldering : 260 °C for 10 sec. Hand Soldering : 350 °C for 3 sec.	

Electro-Optical Characteristics @ Ta=25°C

Parameter	Symbol	Min.	Typ.	Max.	Unit	Condition
Luminous Intensity	I _v	G6	18.0	-----	36.0	mcd I _F =5mA
		R7	28.0	-----	57.0	
Viewing Angle	2θ _{1/2}	-----	130	-----	deg	I _F =5mA
Peak Wavelength	λ _p	G6	-----	575	-----	nm I _F =5mA
		R7	-----	631	-----	
Dominant Wavelength	λ _d	G6	570.5	-----	574.5	nm I _F =5mA
		R7	621.0	-----	628.0	
Spectrum Radiation Bandwidth	Δλ	G6	-----	20	-----	nm I _F =5mA
		R7	-----	20	-----	
Forward Voltage	V _F	G6	1.6	-----	2.2	V I _F =5mA
		R7	1.6	-----	2.2	
Reverse Current	I _R	-----	-----	10	μA	V _R =5V

Notes:

- 1.Tolerance of Luminous Intensity ±10%**
- 2.Tolerance of Dominant Wavelength ±1nm**
- 3.Tolerance of Forward Voltage ±0.1V**

93-22/G6R7C-B01/2A0
Bin Range Of Dominant Wavelength

Chip	Bin Code	Min.	Max.	Unit	Condition
G6	1	570.5	572.5	nm	IF=5mA
	2	572.5	574.5		
R7	1	621.0	624.5		
	2	624.5	628.5		

Bin Range Of Luminous Intensity

Chip	Bin	Min	Max	Unit	Condition
G6	M1	18.0	22.5	mcd	IF=5mA
	M2	22.5	28.5		
	N1	28.5	36.0		
R7	N1	28.5	36.0		
	N2	36.0	45.0		
	P1	45.0	57.0		

Bin Range Of Forward Voltage

Chip	Bin	Min	Max	Unit	Condition
G6	C	1.60	1.95	V	IF=5mA
	D	1.95	2.20		
R7	C	1.60	1.95		
	D	1.95	2.20		

Notes:

- 1.Tolerance of Luminous Intensity $\pm 10\%$
- 2.Tolerance of Dominant Wavelength $\pm 1\text{nm}$
- 3.Tolerance of Forward Voltage $\pm 0.1\text{V}$

Typical Electro-Optical Characteristics Curves(G6)

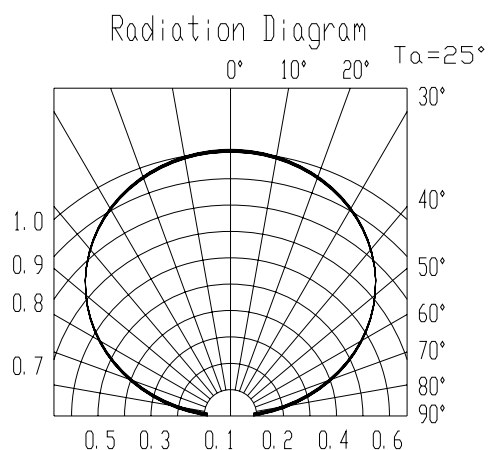
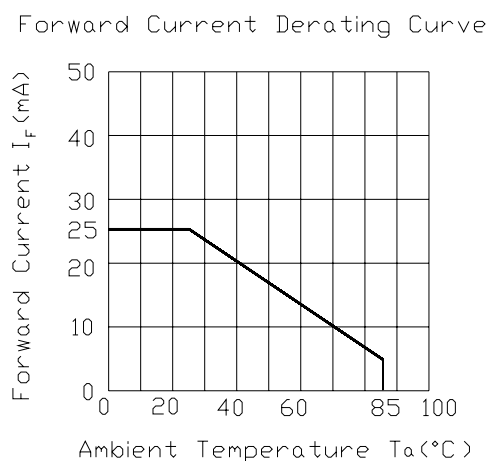
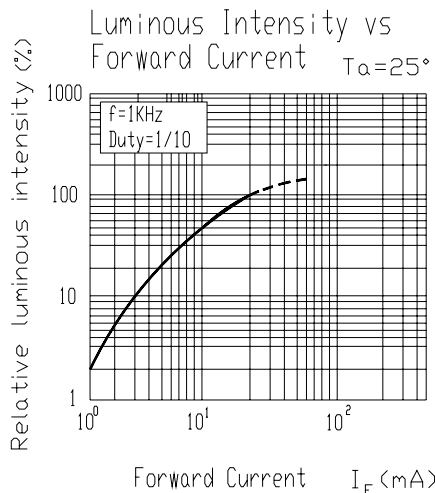
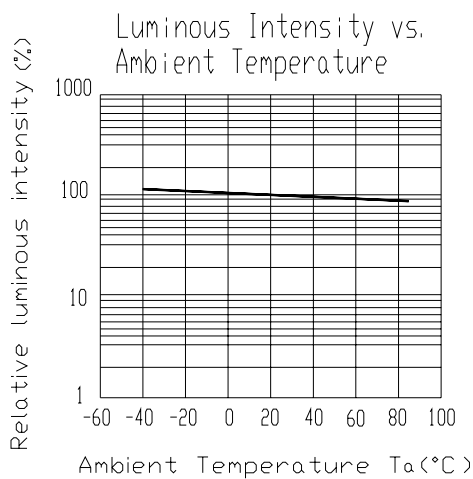
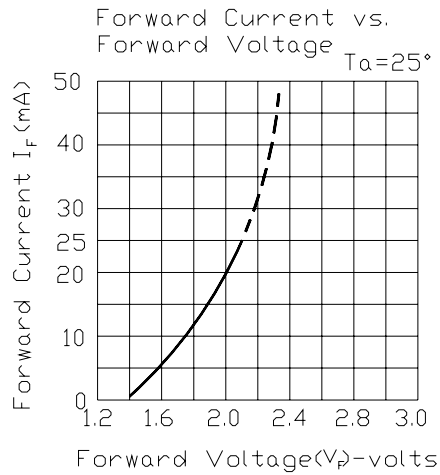
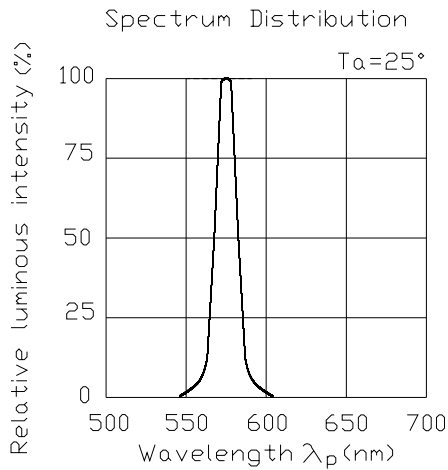

Typical Electro-Optical Characteristics Curves(R7)

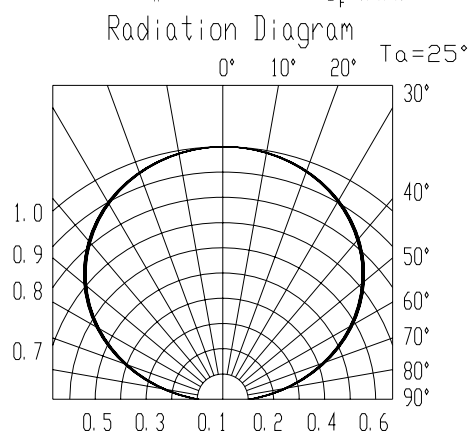
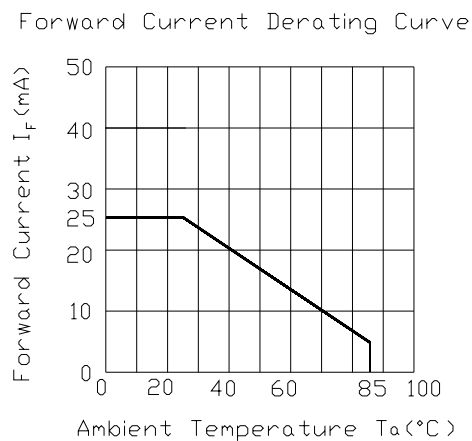
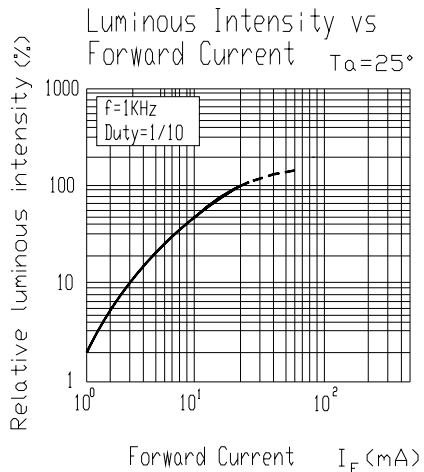
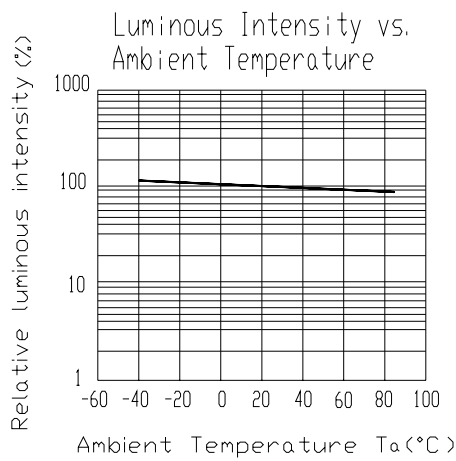
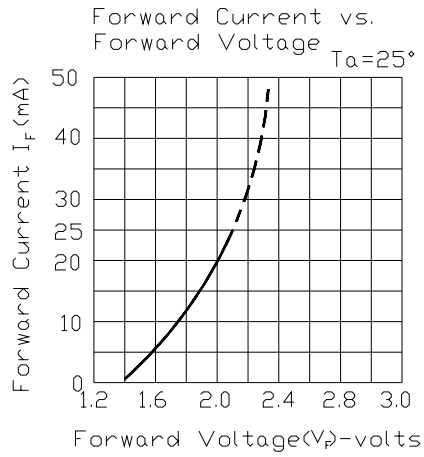
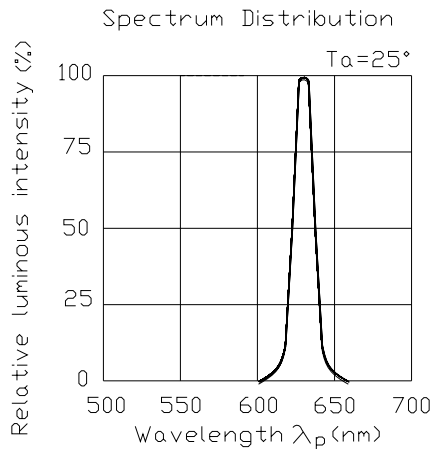

93-22/G6R7C-B01/2A0

Label explanation

CAT: Luminous Intensity Rank

HUE: Dom. Wavelength Rank

REF: Forward Voltage Rank

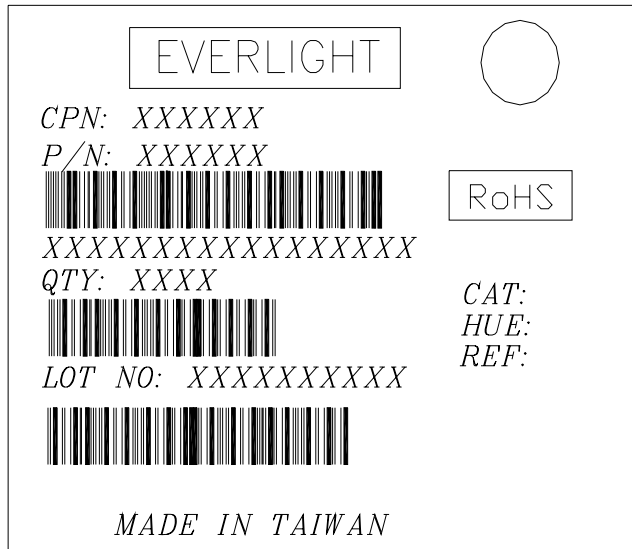

Reel Dimensions

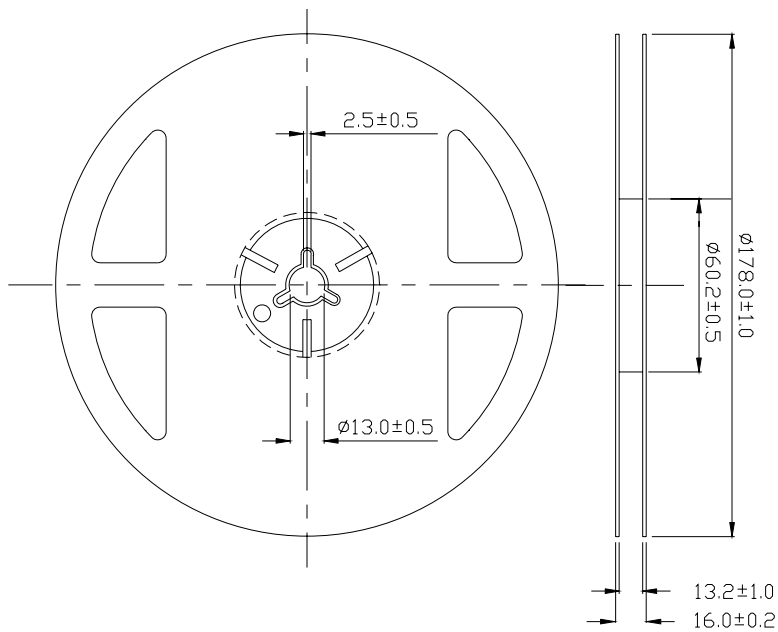

Note: The tolerances unless mentioned is ± 0.1 mm, Unit = mm

Carrier Tape Dimensions: Loaded quantity per reel 1000 PCS/reel

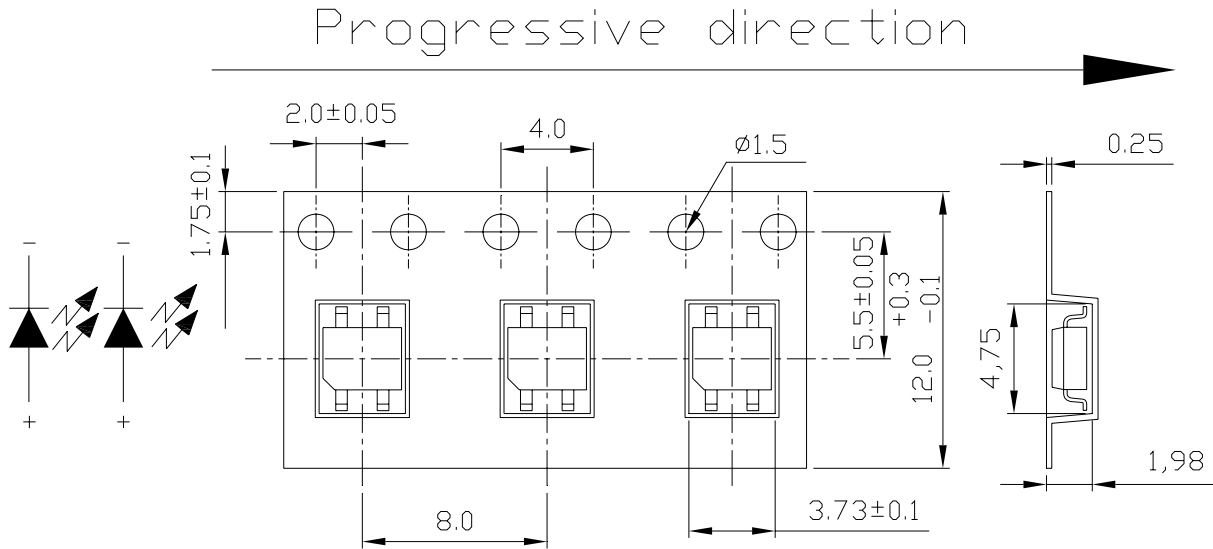

Note: Tolerances Unless Dimension $\pm 0.1\text{mm}$ Unit = mm

Moisture Resistant Packaging

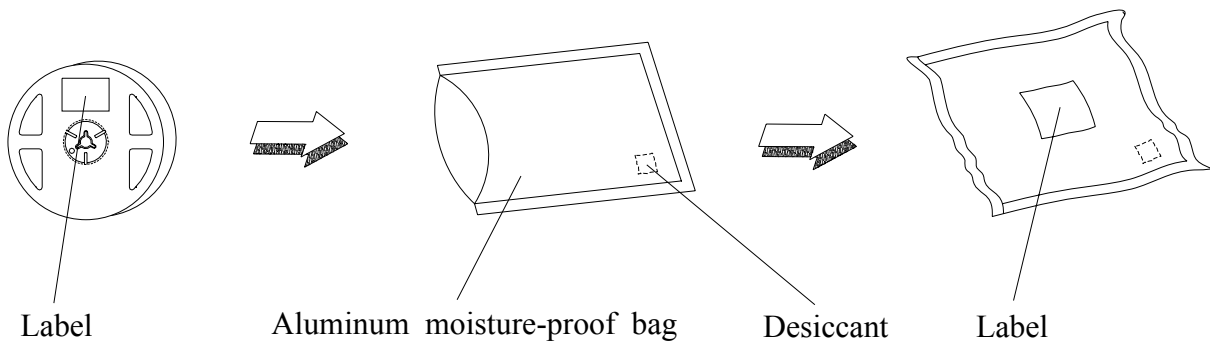

Reliability Test Items And Conditions

The reliability of products shall be satisfied with items listed below.

Confidence level : 90%

LTPD : 10%

No.	Items	Test Condition	Test Hours/Cycles	Sample Size	Ac/Re
1	Reflow Soldering	Temp. : 260°C±5°C Min. 5 sec.	6 Min.	22 PCS.	0/1
2	Temperature Cycle	H : +100°C 15min ∫ 5 min L : -40°C 15min	300 Cycles	22 PCS.	0/1
3	Thermal Shock	H : +100°C 5min ∫ 10 sec L : -10°C 5min	300 Cycles	22 PCS.	0/1
4	High Temperature Storage	Temp. : 100°C	1000 Hrs.	22 PCS.	0/1
5	Low Temperature Storage	Temp. : -40°C	1000 Hrs.	22 PCS.	0/1
6	DC Operating Life	I _F = 20 mA / 25°C	1000 Hrs.	22 PCS.	0/1
7	High Temperature / High Humidity	85°C/85%RH	1000 Hrs.	22 PCS.	0/1

Precautions For Use

1. Over-current-proof

Customer must apply resistors for protection, otherwise slight voltage shift will cause big current change (Burn out will happen).

2. Storage

2.1 Do not open moisture proof bag before the products are ready to use.

2.2 Before opening the package: The LEDs should be kept at 30°C or less and 90%RH or less.

2.3 After opening the package: The LED's floor life is 1 year under 30°C or less and 60% RH or less.

If unused LEDs remain, it should be stored in moisture proof packages.

2.4 If the moisture absorbent material (silica gel) has faded away or the LEDs have exceeded the storage time, baking treatment should be performed using the following conditions.

Baking treatment : 60±5°C for 24 hours.

3. Soldering Condition

3.1 Pb-free solder temperature profile

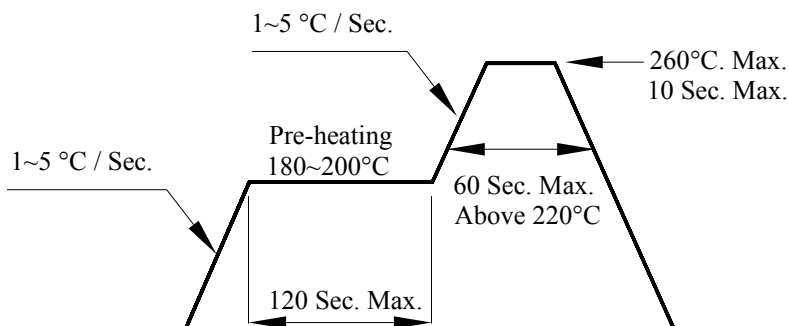

3.2 Reflow soldering should not be done more than two times.

3.3 When soldering, do not put stress on the LEDs during heating.

3.4 After soldering, do not warp the circuit board.

4. Soldering Iron

Each terminal is to go to the tip of soldering iron temperature less than 350°C for 3 seconds within once in less than the soldering iron capacity 25W. Leave two seconds and more intervals, and do soldering of each terminal. Be careful because the damage of the product is often started at the time of the hand solder.

5.Repairing

Repair should not be done after the LEDs have been soldered. When repairing is unavoidable, a double-head soldering iron should be used (as below figure). It should be confirmed beforehand whether the characteristics of the LEDs will or will not be damaged by repairing.

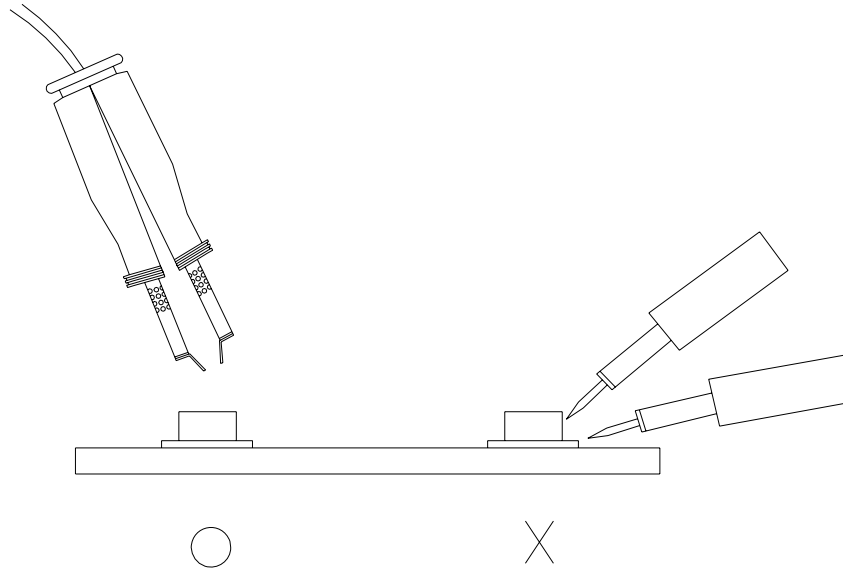

EVERLIGHT ELECTRONICS CO., LTD.
Office: No 25, Lane 76, Sec 3, Chung Yang Rd,
Tucheng, Taipei 236, Taiwan, R.O.C

Tel: 886-2-2267-2000, 2267-9936
Fax: 886-2267-6244, 2267-6189, 2267-6306
<http://www.everlight.com>