



## 7111 Bi-directional totalising Counter.

## 7111QUAD Totalising counter with quadrature inputs.

## 7111HV Bi-directional totalising counter with high voltage inputs.

### 7111 | 7111QUAD | 7111HV

The new 7111 series counter is feature packed and with a price performance ratio unrivalled, suitable for thousands of applications.

#### Features

- Use of the latest CMOS circuitry achieves an expected battery life of 10 years.
- Connection using built in screw terminals (on all models).
- 9mm black high contrast LCD display.
- Backlight (externally powered) 5VDC.
- Counting up to 10kHz. (7111)
- 7111QUAD version quadrature signal compatible. This permits add / subtract counting in step with forward / reverse motion without count loss or gaining spurious counts.
- 7111HV permits triggering from any voltage between 10-240VAC or 5-110VDC  $\pm 10\%$ .
- Contact closure/open collector low speed count input with integral de-bounce circuitry (7111 model).
- Choice of mounting available, front panel with supplied bezel or rear mounting clip.
- Front panel can be sealed to IP65.
- Installation is simplified - all models have screw connections on rear for quick and simple connection.
- UL and cUL pending.

#### General Specifications

**Battery** Non-replaceable Lithium battery, expected life 10 years at 20°C

**Display** 8 digit black LCD, 9mm characters, leading zero blanking, backlight requires external 5VDC supply. Configurable decimal place upto 3 dec place (jumper link configured).

**Count Range** 99999999 - rollover to 0

**Connections** Finger-proof screw connections for cables up to 1.5mm<sup>2</sup>

**Operating temperature** -10°C to +60°C

**Storage temperature** -20°C to +60°C

**Altitude** Up to 2000m

**Relative Humidity** 80% max up to 31°C, decreasing to 50% max at 40°C

**Sealing** IP65/NEMA4X

**Mounting** Either with clip mount supplied or two front screws with bezel supplied.

**Manual Reset Enable** Configured by jumper link

**Packed Weight** 62 grammes

**Box Dimensions** 56mm x 44mm x 62mm

#### Individual Product Specifications

##### Power Supply (7111QUAD)

External power supply to power internal count input circuits 10-30VDC

##### External Reset (7111 | 7111QUAD)

Contact closure/open collector, negative edge triggered, 0.7v threshold, 15mS minimum closure time.

##### Direction Input (7111)

Connection or electronic input TTL/CMOS compatible. Add=no connection or >2.4v (logic 1); Subtract=connect to COMMON or <0.7v (logic 0). Direction input must precede count input by 5µS (minimum) for valid operation.

##### Low Speed Count Input (7111)

Contact closure/open collector with integral de-bounce circuitry. 30Hz maximum, negative edge triggered, 0.7v threshold, 15mS minimum closure time. Max 18VDC.

##### High Speed Count Input (7111)

Electronic input 10kHz maximum, negative edge triggered, 0.7v threshold 50µS minimum pulse length, TTL/CMOS Compatible. Max 18VDC.

##### Quadrature Signal Inputs (7111 QUAD)

Electronic input 2.5kHz maximum, negative edge triggered, 0.7v threshold 200µS minimum pulse length, TTL/CMOS Compatible.

##### External Reset (7111HV)

10-110VDC  $\pm 10\%$ , 10-240VAC  $\pm 10\%$ , 50mS minimum length.

##### Direction Input (7111HV)

Connection or electronic input TTL/CMOS compatible. Add=no connection or >2.4v (logic 1); Subtract=connect to COMMON or <0.7v (logic 0). Direction input must precede count input by 5µS (minimum) for valid operation. Max 18VDC.

##### Count Input (7111HV)

10-110VDC  $\pm 10\%$ , 10-240VAC  $\pm 10\%$ , 50mS minimum pulse width, 10Hz.

#### Rear view screw terminal connections.

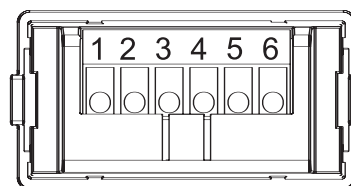

#### Typical Applications

- Replacement for electro-mechanical counters.
- Applications where external power is not readily available.
- Position, length, rotation and distance measuring applications.
- Event counting

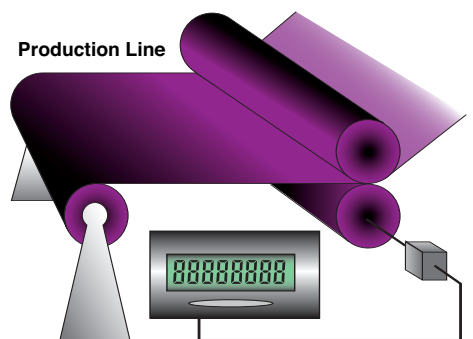

#### Product Dimensions

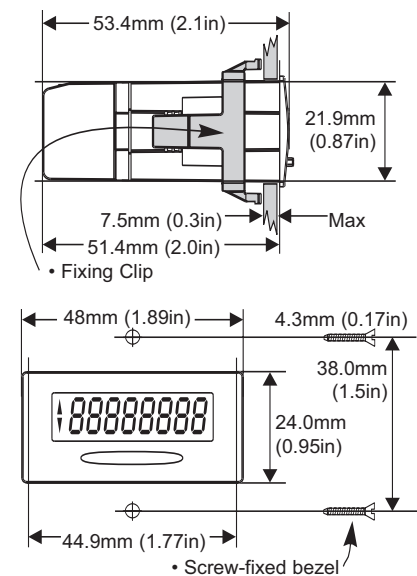

Panel cutout 45mm x 22.5mm ( 1.771" x 0.885")

#### ORDER INFORMATION

Order by type numbers of counter:

- 7111** Totalising counter
- 7111QUAD** Up/Down with quad IP's
- 7111HV** Counter with HV inputs