



MICROCHIP

**MTS2916A
Dual Full-Bridge Stepper
Motor Driver
Evaluation Board
User's Guide**

Note the following details of the code protection feature on Microchip devices:

- Microchip products meet the specification contained in their particular Microchip Data Sheet.
- Microchip believes that its family of products is one of the most secure families of its kind on the market today, when used in the intended manner and under normal conditions.
- There are dishonest and possibly illegal methods used to breach the code protection feature. All of these methods, to our knowledge, require using the Microchip products in a manner outside the operating specifications contained in Microchip's Data Sheets. Most likely, the person doing so is engaged in theft of intellectual property.
- Microchip is willing to work with the customer who is concerned about the integrity of their code.
- Neither Microchip nor any other semiconductor manufacturer can guarantee the security of their code. Code protection does not mean that we are guaranteeing the product as "unbreakable."

Code protection is constantly evolving. We at Microchip are committed to continuously improving the code protection features of our products. Attempts to break Microchip's code protection feature may be a violation of the Digital Millennium Copyright Act. If such acts allow unauthorized access to your software or other copyrighted work, you may have a right to sue for relief under that Act.

Information contained in this publication regarding device applications and the like is provided only for your convenience and may be superseded by updates. It is your responsibility to ensure that your application meets with your specifications. MICROCHIP MAKES NO REPRESENTATIONS OR WARRANTIES OF ANY KIND WHETHER EXPRESS OR IMPLIED, WRITTEN OR ORAL, STATUTORY OR OTHERWISE, RELATED TO THE INFORMATION, INCLUDING BUT NOT LIMITED TO ITS CONDITION, QUALITY, PERFORMANCE, MERCHANTABILITY OR FITNESS FOR PURPOSE. Microchip disclaims all liability arising from this information and its use. Use of Microchip devices in life support and/or safety applications is entirely at the buyer's risk, and the buyer agrees to defend, indemnify and hold harmless Microchip from any and all damages, claims, suits, or expenses resulting from such use. No licenses are conveyed, implicitly or otherwise, under any Microchip intellectual property rights.

Trademarks

The Microchip name and logo, the Microchip logo, dsPIC, FlashFlex, KEELOQ, KEELOQ logo, MPLAB, PIC, PICmicro, PICSTART, PIC³² logo, rPIC, SST, SST Logo, SuperFlash and UNI/O are registered trademarks of Microchip Technology Incorporated in the U.S.A. and other countries.

FilterLab, Hampshire, HI-TECH C, Linear Active Thermistor, MTP, SEEVAL and The Embedded Control Solutions Company are registered trademarks of Microchip Technology Incorporated in the U.S.A.

Silicon Storage Technology is a registered trademark of Microchip Technology Inc. in other countries.

Analog-for-the-Digital Age, Application Maestro, BodyCom, chipKIT, chipKIT logo, CodeGuard, dsPICDEM, dsPICDEM.net, dsPICworks, dsSPEAK, ECAN, ECONOMONITOR, FanSense, HI-TIDE, In-Circuit Serial Programming, ICSP, Mindi, MiWi, MPASM, MPF, MPLAB Certified logo, MPLIB, MPLINK, mTouch, Omniscent Code Generation, PICC, PICC-18, PICDEM, PICDEM.net, PICkit, PICtail, REAL ICE, rLAB, Select Mode, SQI, Serial Quad I/O, Total Endurance, TSHARC, UniWinDriver, WiperLock, ZENA and Z-Scale are trademarks of Microchip Technology Incorporated in the U.S.A. and other countries.

SQTP is a service mark of Microchip Technology Incorporated in the U.S.A.

GestIC and ULPP are registered trademarks of Microchip Technology Germany II GmbH & Co. KG, a subsidiary of Microchip Technology Inc., in other countries.

All other trademarks mentioned herein are property of their respective companies.

© 2012-2013, Microchip Technology Incorporated, Printed in the U.S.A., All Rights Reserved.

 Printed on recycled paper.

ISBN: 978-1-62077-339-0

**QUALITY MANAGEMENT SYSTEM
CERTIFIED BY DNV
= ISO/TS 16949 =**

Microchip received ISO/TS-16949:2009 certification for its worldwide headquarters, design and wafer fabrication facilities in Chandler and Tempe, Arizona; Gresham, Oregon and design centers in California and India. The Company's quality system processes and procedures are for its PIC[®] MCUs and dsPIC[®] DSCs, KEELOQ[®] code hopping devices, Serial EEPROMs, microperipherals, nonvolatile memory and analog products. In addition, Microchip's quality system for the design and manufacture of development systems is ISO 9001:2000 certified.



MICROCHIP

MTS2916A DUAL FULL-BRIDGE STEPPER MOTOR DRIVER EVALUATION BOARD USER'S GUIDE

Table of Contents

Preface	5
Introduction.....	5
Document Layout	5
Conventions Used in this Guide	6
Recommended Reading.....	7
The Microchip Web Site	7
Customer Support	7
Document Revision History	7
Chapter 1. Product Overview	
1.1 Introduction	9
1.2 MTS2916A Short Overview	9
1.3 What is the MTS2916A Dual Full-Bridge Stepper Motor Driver Evaluation Board?	10
1.4 MTS2916A Dual Full-Bridge Stepper Motor Driver Evaluation Board Kit Contents	10
Chapter 2. Installation and Operation	
2.1 Introduction	11
2.2 Power Connections	11
2.3 Features	12
2.4 Getting Started	13
2.5 Key Components	14
2.6 Modes	14
Appendix A. Schematic and Layouts	
A.1 Introduction	17
A.2 Board – Schematic	18
A.3 Board – Top Silk	19
A.4 Board – Top Pads and Silk	20
A.5 Board – Bottom Copper	21
Appendix B. Bill of Materials	
Appendix C. Mode Sequence Diagrams	
C.1 MTS2916A Dual Full-Bridge Stepper Motor Driver Evaluation Board Functional Flowchart	25
C.2 Single Stepping Example	26
C.3 MTS2916A Dual Full-Bridge Stepper Motor Driver Evaluation Board Software Flowcharts	27
Worldwide Sales and Service	40

Object of Declaration: MTS2916A Dual Full-Bridge Stepper Motor Driver
Evaluation Board User's Guide

EU Declaration of Conformity

This declaration of conformity is issued by the manufacturer.

The development/evaluation tool is designed to be used for research and development in a laboratory environment. This development/evaluation tool is not a Finished Appliance, nor is it intended for incorporation into Finished Appliances that are made commercially available as single functional units to end users under EU EMC Directive 2004/108/EC and as supported by the European Commission's Guide for the EMC Directive 2004/108/EC (8th February 2010).

This development/evaluation tool complies with EU RoHS2 Directive 2011/65/EU.

For information regarding the exclusive, limited warranties applicable to Microchip products, please see Microchip's standard terms and conditions of sale, which are printed on our sales documentation and available at www.microchip.com.

Signed for and on behalf of Microchip Technology Inc. at Chandler, Arizona, USA

Derek Carlson
VP Development Tools

16-July-2013
Date



MICROCHIP

MTS2916A DUAL FULL-BRIDGE STEPPER MOTOR DRIVER EVALUATION BOARD USER'S GUIDE

Preface

NOTICE TO CUSTOMERS

All documentation becomes dated, and this manual is no exception. Microchip tools and documentation are constantly evolving to meet customer needs, so some actual dialogs and/or tool descriptions may differ from those in this document. Please refer to our web site (www.microchip.com) to obtain the latest documentation available.

Documents are identified with a “DS” number. This number is located on the bottom of each page, in front of the page number. The numbering convention for the DS number is “DSXXXXA”, where “XXXX” is the document number and “A” is the revision level of the document.

For the most up-to-date information on development tools, see the MPLAB® IDE online help. Select the Help menu, and then Topics to open a list of available online help files.

INTRODUCTION

This chapter contains general information that will be useful to know before using the MTS2916A Dual Full-Bridge Stepper Motor Driver Evaluation Board. This evaluation board also demonstrates the capabilities of the MTS62C19A, which has the same functionality, but different pin assignments. Items discussed in this chapter include:

- Document Layout
- Conventions Used in this Guide
- Recommended Reading
- The Microchip Web Site
- Customer Support
- Document Revision History

DOCUMENT LAYOUT

This document describes how to use the MTS2916A Dual Full-Bridge Stepper Motor Driver Evaluation Board as a development tool. The manual layout is as follows:

- **Chapter 1. “Product Overview”** – Important information about the MTS2916A Dual Full-Bridge Stepper Motor Driver Evaluation Board
- **Chapter 2. “Installation and Operation”** – Describes the initial setup of this board and the key components
- **Appendix A. “Schematic and Layouts”** – Shows the schematic and board layouts for the MTS2916A Dual Full-Bridge Stepper Motor Driver Evaluation Board
- **Appendix B. “Bill of Materials”** – Lists the parts used to populate the MTS2916A Dual Full-Bridge Stepper Motor Driver Evaluation Board
- **Appendix C. “Mode Sequence Diagrams”** – Shows functional and software flowcharts for the MTS2916A Dual Full-Bridge Stepper Motor Driver Evaluation Board

CONVENTIONS USED IN THIS GUIDE

This manual uses the following documentation conventions:

DOCUMENTATION CONVENTIONS

Description	Represents	Examples
Arial font:		
Italic characters	Referenced books	<i>MPLAB[®] IDE User's Guide</i>
	Emphasized text	...is the <i>only</i> compiler...
Initial caps	A window	the Output window
	A dialog	the Settings dialog
	A menu selection	select Enable Programmer
Quotes	A field name in a window or dialog	"Save project before build"
Underlined, italic text with right angle bracket	A menu path	<u><i>File>Save</i></u>
Bold characters	A dialog button	Click OK
	A tab	Click the Power tab
N'Rnnnn	A number in verilog format, where N is the total number of digits, R is the radix and n is a digit.	4'b0010, 2'hF1
Text in angle brackets < >	A key on the keyboard	Press <Enter>, <F1>
Courier New font:		
Plain Courier New	Sample source code	#define START
	Filenames	autoexec.bat
	File paths	c:\mcc18\h
	Keywords	_asm, _endasm, static
	Command-line options	-Opa+, -Opa-
	Bit values	0, 1
	Constants	0xFF, 'A'
Italic Courier New	A variable argument	<i>file.o</i> , where <i>file</i> can be any valid filename
Square brackets []	Optional arguments	mcc18 [options] <i>file</i> [options]
Curly brackets and pipe character: { }	Choice of mutually exclusive arguments; an OR selection	errorlevel {0 1}
Ellipses...	Replaces repeated text	var_name [, var_name...]
	Represents code supplied by user	void main (void) { ... }

RECOMMENDED READING

This user's guide describes how to use MTS2916A Dual Full-Bridge Stepper Motor Driver Evaluation Board. Another useful document is listed below. The following Microchip document is available and recommended as a supplemental reference resource.

- **MTS2916A Data Sheet – “Dual Full-Bridge Motor Driver” (DS22259)**

THE MICROCHIP WEB SITE

Microchip provides online support via our web site at www.microchip.com. This web site is used as a means to make files and information easily available to customers. Accessible by using your favorite Internet browser, the web site contains the following information:

- **Product Support** – Data sheets and errata, application notes and sample programs, design resources, user's guides and hardware support documents, latest software releases and archived software
- **General Technical Support** – Frequently Asked Questions (FAQs), technical support requests, online discussion groups, Microchip consultant program member listing
- **Business of Microchip** – Product selector and ordering guides, latest Microchip press releases, listing of seminars and events, listings of Microchip sales offices, distributors and factory representatives

CUSTOMER SUPPORT

Users of Microchip products can receive assistance through several channels:

- Distributor or Representative
- Local Sales Office
- Field Application Engineer (FAE)
- Technical Support

Customers should contact their distributor, representative or field application engineer (FAE) for support. Local sales offices are also available to help customers. A listing of sales offices and locations is included in the back of this document.

Technical support is available through the web site at:
<http://www.microchip.com/support>.

DOCUMENT REVISION HISTORY

Revision B (July 2013)

- Corrected minor error in [Section 2.1 “Introduction”](#).

Revision A (May 2012)

- Initial Release of this Document.

NOTES:



MICROCHIP

MTS2916A DUAL FULL-BRIDGE STEPPER MOTOR DRIVER EVALUATION BOARD USER'S GUIDE

Chapter 1. Product Overview

1.1 INTRODUCTION

This chapter provides an overview of the MTS2916A Dual Full-Bridge Stepper Motor Driver Evaluation Board and covers the following topics:

- MTS2916A Short Overview
- What is the MTS2916A Dual Full-Bridge Stepper Motor Driver Evaluation Board?
- MTS2916A Dual Full-Bridge Stepper Motor Driver Evaluation Board Kit Contents

1.2 MTS2916A SHORT OVERVIEW

The MTS2916A stepper motor driver is a CMOS device capable of driving both windings of a bipolar stepper motor or bidirectionally controlling two DC motors. Only the stepper motor application is covered by this user's guide. Each of the two independent H-Bridge outputs is capable of sustaining 40V and delivering 750 mA of continuous current. The user must ensure that the thermal guidelines are followed and the driver does not exceed the maximum junction temperature of +150°C. The driver will typically enter in thermal shutdown at a junction temperature of +170°C. The output current level is controlled by an internal Pulse-Width Modulation (PWM) circuit that is configured using two logic inputs, a current sense resistor and a selectable reference voltage.

Full, half and microstepping operations are possible with the PWM current control and logic inputs. The maximum output current is set by a sense resistor and a user selectable voltage reference. The evaluation board voltage reference is controlled with the run switch and is detailed in [Section 2.4.1 "Powering the MTS2916A Dual Full-Bridge Stepper Motor Driver Evaluation Board"](#). Each bridge has an independent phase input that controls the current flow direction for its specific load.

Internal clamp diodes protect against inductive voltage transients. The thermal protection circuitry disables the outputs when the junction temperature exceeds the thermal protection threshold. The thermal protection circuitry typically has 25°C of hysteresis. Undervoltage lockout circuitry prevents the outputs from going active until the logic supply voltage is high enough to assume control. No special power-up sequencing is required.

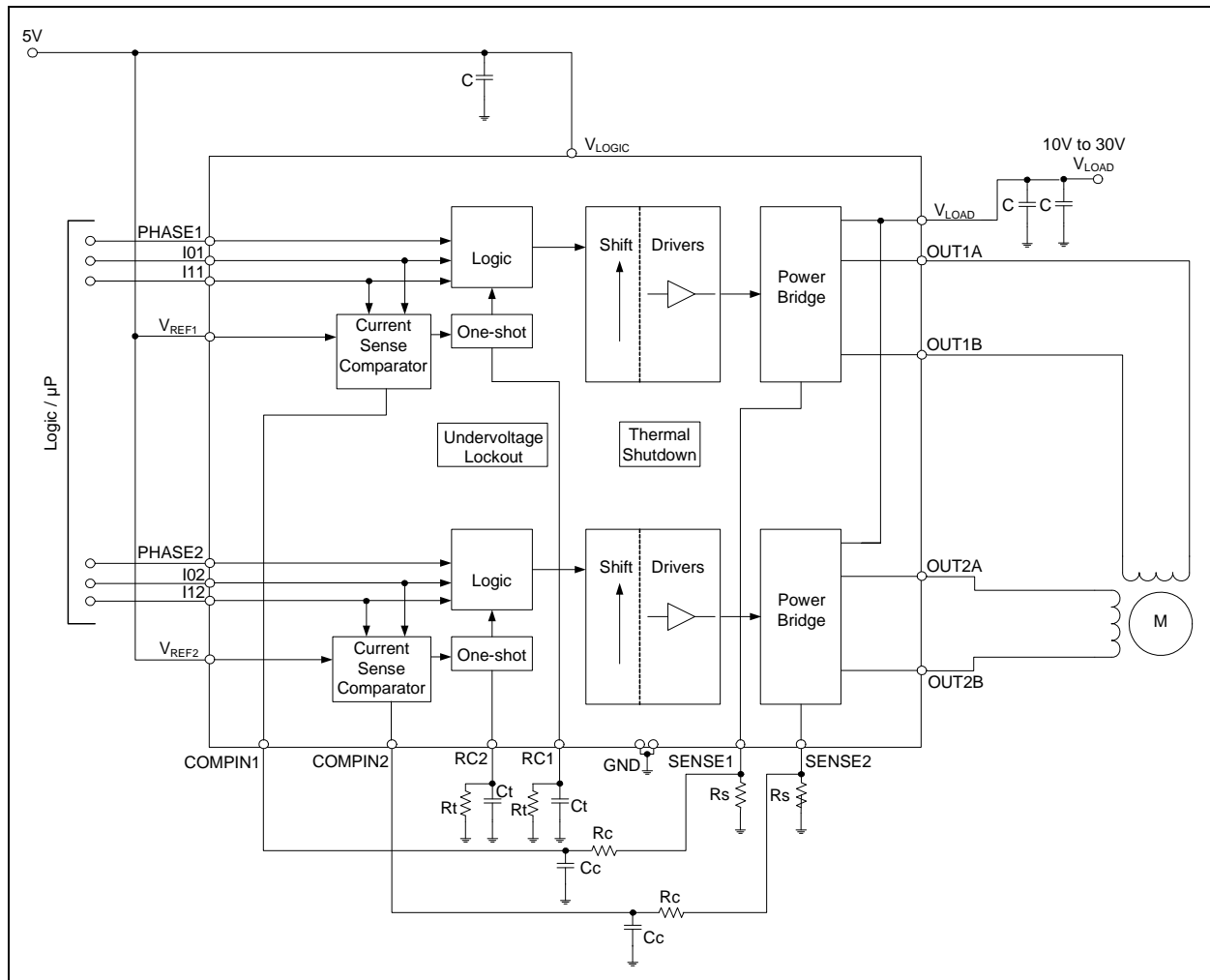

FIGURE 1-1: Typical MTS2916A Stepper Motor Driver Application.

1.3 WHAT IS THE MTS2916A DUAL FULL-BRIDGE STEPPER MOTOR DRIVER EVALUATION BOARD?

The MTS2916A Dual Full-Bridge Stepper Motor Driver Evaluation Board control circuitry is designed to typically operate from a 6V to 12V logic input (internally regulated down to 5V) and a 10V to 30V V_{LOAD} input. V_{LOAD} provides power to the motor windings. Test points are generously distributed throughout the evaluation board. This gives the user easy access and visibility, facilitating a better understanding of the MTS2916A operating details.

1.4 MTS2916A DUAL FULL-BRIDGE STEPPER MOTOR DRIVER EVALUATION BOARD KIT CONTENTS

The MTS2916A Dual Full-Bridge Stepper Motor Driver Evaluation Board kit contains the following items:

- MTS2916A Dual Full-Bridge Stepper Motor Driver Evaluation Board (ADM00308)
- Important Information Sheet



MTS2916A DUAL FULL-BRIDGE STEPPER MOTOR DRIVER EVALUATION BOARD USER'S GUIDE

Chapter 2. Installation and Operation

2.1 INTRODUCTION

The MTS2916A Dual Full-Bridge Stepper Motor Driver Evaluation Board demonstrates the capabilities of the MTS2916A to control both windings of a bipolar stepper motor. The board also demonstrates the capabilities of the MTS62C19A, which has the same functionality, but different pin assignments. A PIC16F883 is utilized for motor control processing.

This evaluation board incorporates features through the implementation of push-button switches and a variable speed input potentiometer to exercise a stepper motor in Full-Step, Half-Step, Modified Half-Step and Microstepping modes. LEDs indicate a binary representation of which mode has been selected. The evaluation board and the stepper motor can be powered from a single power input J1 (7 VDC to 12 VDC) with jumper JP2 installed. For higher motor voltages, make sure JP2 is *not* installed, and connect V_{LOAD} at J4. Numerous test points have been designed into the board to allow easy access.

2.2 POWER CONNECTIONS

The MTS2916A Dual Full-Bridge Stepper Motor Driver Evaluation Board uses a combination of terminal blocks, test clips and one DC power jack for power connections.

Connections are as follows:

- a) Motor Output Connections:
 - J2-1(A3), J2-2(A1), J2-3(B1), J2-4(B3), J2-5(TP21)
 - TP11(A1), TP12(A3), TP13(B1), TP14(B3)
- b) V_{LOAD} (Motor Supply Power):
 - J4-1(PGND), J4-2(V_{LOAD})
 - TP20(PGND), TP18(V_{LOAD})

WARNING

Do not connect more than 16V to these motor supply connections while Jumper JP2 is installed.

- c) V_{LOGIC} :
 - J1-1(VLOGIC), J1-2(AGND)
 - TP2(VLOGIC), TP5(AGND)

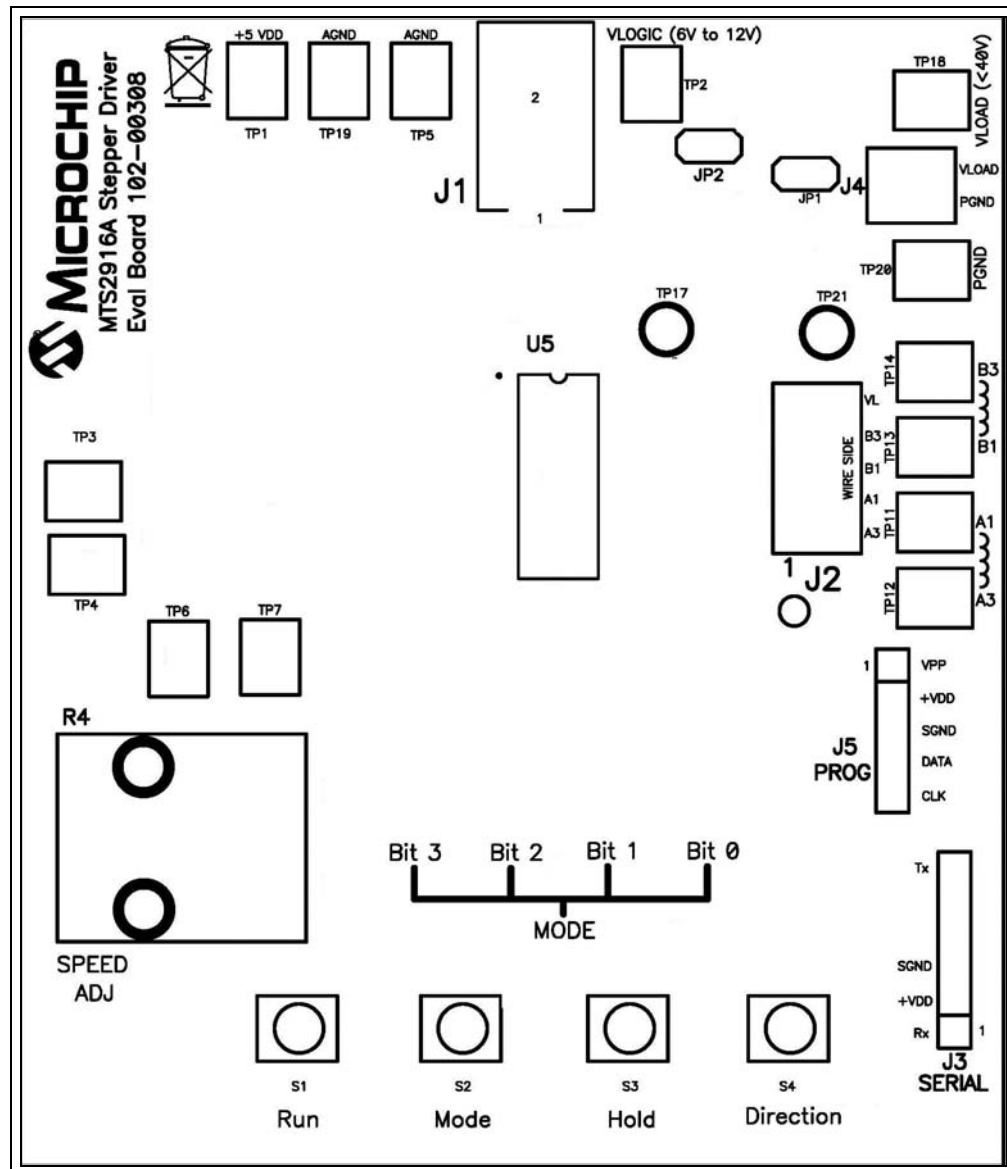

FIGURE 2-1: Power Connection Diagram.

2.3 FEATURES

The MTS2916A Dual Full-Bridge Stepper Motor Driver Evaluation Board has the following features:

- Push Button mode, Run, Hold and Direction control
- Potentiometer variable speed adjustment
- LED mode indication
- Maximum winding current with the combination of R_s , V_{REF} and conditioning of I0/I1 logic inputs
- PICkit™ Programming connector (J5) to implement user-created code

2.4 GETTING STARTED

The MTS2916A Dual Full-Bridge Stepper Motor Driver Evaluation Board is fully assembled and tested driving a dual coil bipolar stepper motor.

2.4.1 Powering the MTS2916A Dual Full-Bridge Stepper Motor Driver Evaluation Board

Follow these steps to power-up the board:

1. With the supply turned OFF, connect the power to the logic portion of the evaluation board at J1 with the specified voltage (7 VDC to 12 VDC). The logic portion of the evaluation board will typically draw less than 50 mA.
2. If the user's stepper motor requires a voltage that is compatible with the logic supply voltage and the user's source can handle driving the stepper motor windings, install JP2. *DO NOT* connect power at J4. If powering up the stepper from an additional supply, *DO NOT* install JP2 and connect the stepper motor supply to J4. J1 power will still be required for the logic supply.
3. Connect the bipolar stepper windings to J2 per the schematic diagram.
4. Turn ON the power supplies. Power sequencing is not required due to the under-voltage lockout circuitry.
5. Toggle the Mode switch to cycle through the five modes, as indicated by the binary LED count.
6. Press the Run switch once to tell the PIC16F883 to send drive information to the MTS2916A with minimal (1V) V_{REF} . Subsequent Run presses increase V_{REF} by approximately 1V up to 5V maximum. This increases the current regulation threshold.
7. The Hold switch tells the PIC16F883 to command the MTS2916A to hold the motor position.
8. The Direction switch tells the PIC16F883 to command the MTS2916A to change the direction of the motor.
9. The Speed Adjust Potentiometer (R4) varies an analog voltage that is read by the PIC16F883 Analog-to-Digital Converter, and varies the speed accordingly.

Logic inputs I0 and I1 control load current levels are shown in [Table 2-1](#):

TABLE 2-1: CURRENT LEVEL CONTROL

I0	I1	Comparator Trip Voltage	Output Current
0	0	$V_{TRIP} = 1/10 \times V_{REF}$	$I_{MAX} = V_{REF}/10 \times R_S$
1	0	$V_{TRIP} = 1/15 \times V_{REF}$	$2/3 \times I_{MAX} = V_{REF}/15 \times R_S$
0	1	$V_{TRIP} = 1/30 \times V_{REF}$	$1/3 \times I_{MAX} = V_{REF}/30 \times R_S$
1	1	x	0 (no current)

2.5 KEY COMPONENTS

Some of the key components on the evaluation board may need to be adjusted, depending on the characteristics of the utilized motor. The fixed Off Time (t_{OFF}) is set by the combination of R_t and C_t and is determined by the expression:

$$t_{OFF} = 1.1 \times R_t \times C_t$$

The evaluation board is designed with $t_{OFF} = 24.2 \mu s$.

The amount of time it takes for the winding current to reach the regulation point is determined by multiple factors, such as motor voltage, inductance, resistance and the set point threshold.

The set point threshold is determined by the states of I0/I1, V_{REF} and the sense resistance value. For details on set point thresholds and component values, see the MTS2916A Data Sheet (DS22259).

Explaining the effects of the motor characteristics is beyond the scope of this user's guide; however, the t_{OFF} time of $24.2 \mu s$ was chosen to cover most motor applications while trying to maintain a switching frequency above the 20 kHz audible range.

There is a single pole filter in the sense feedback used to set a break frequency of approximately 80 kHz. Depending on the application, this break frequency may need to be adjusted. This may be apparent when designing to regulate at low currents.

2.6 MODES

The following plots were taken from a single winding of a bipolar stepper motor.

TABLE 2-2: MODE 1 VALUES

Full Step	
CH1: Phase 1	$V_{REF} = 1.94V$
CH2: I01	Speed = 0.43V
CH3: I11	$V_{LOAD} = 24V$
CH4: Coil Current	

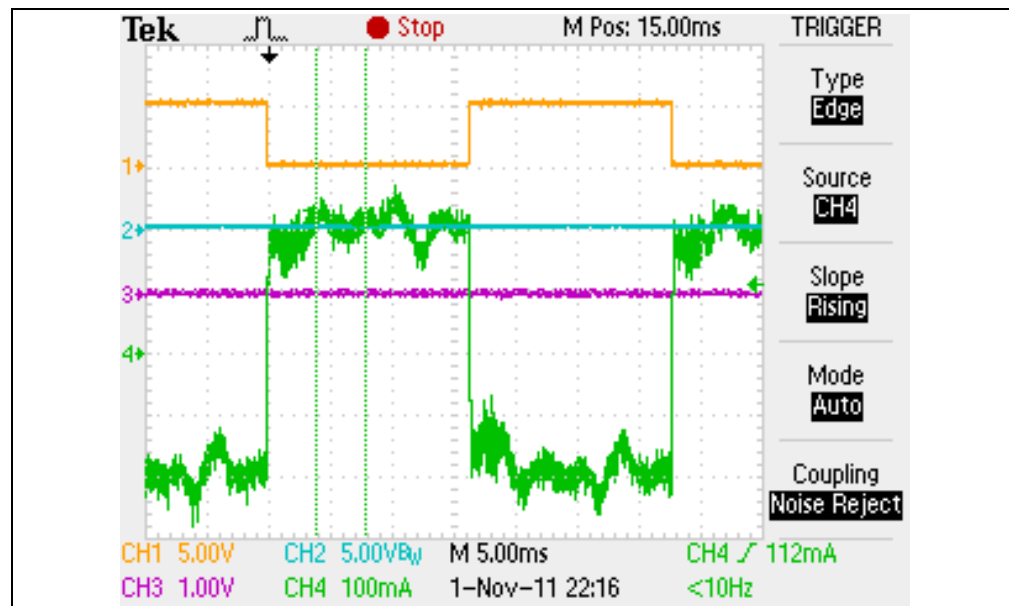

FIGURE 2-2: Mode 1 Plot.

TABLE 2-3: MODE 2 VALUES

Half Step	
CH1: Phase 1	$V_{REF} = 3.87V$
CH2: I01	Speed = 0.43V
CH3: I11	$V_{LOAD} = 24V$
CH4: Coil Current	

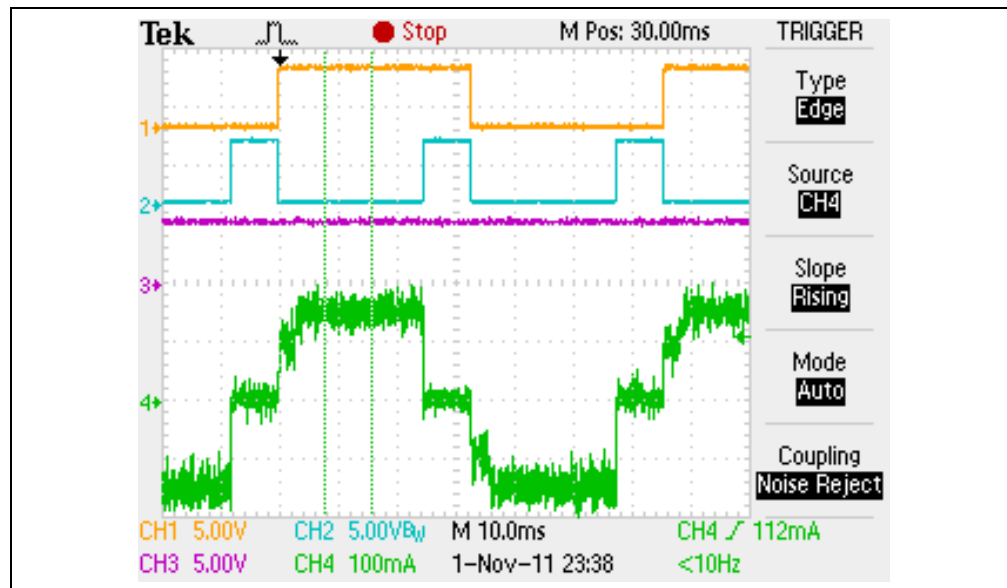

FIGURE 2-3: Mode 2 Plot.

TABLE 2-4: MODE 3 VALUES

Modified Half Step	
CH1: Phase 1	$V_{REF} = 3.87V$
CH2: I01	Speed = 0.43V
CH3: I11	$V_{LOAD} = 24V$
CH4: Coil Current	

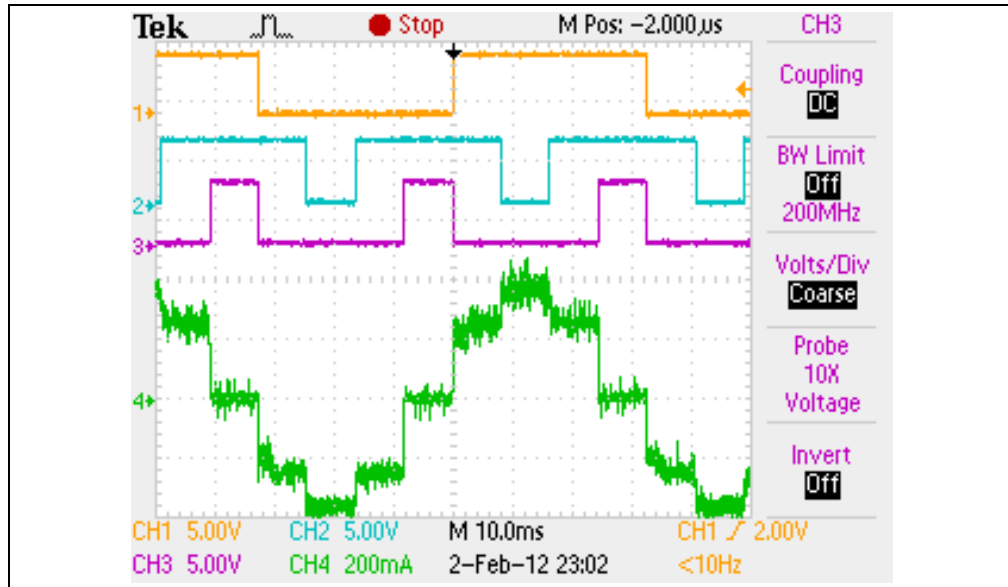

FIGURE 2-4: Mode 3 Plot.

TABLE 2-5: MODE 4 VALUES

Micro Step	
CH1: Phase 1	$V_{REF} = 3.87V$
CH2: I01	Speed = 0.43V
CH3: I11	$V_{LOAD} = 24V$
CH4: Coil Current	

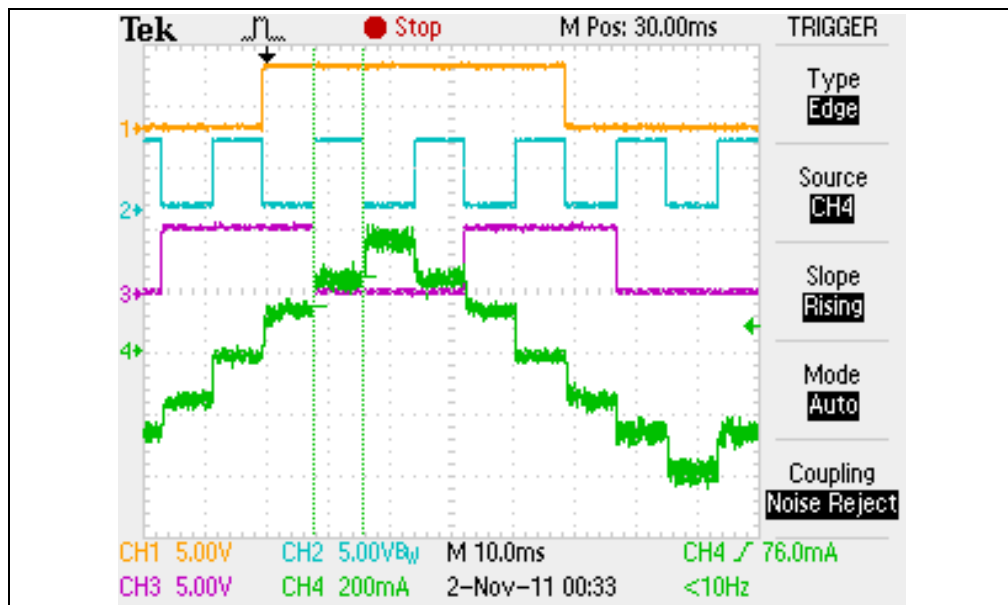

FIGURE 2-5: Mode 4 Plot.



MICROCHIP

MTS2916A DUAL FULL-BRIDGE STEPPER MOTOR DRIVER EVALUATION BOARD USER'S GUIDE

Appendix A. Schematic and Layouts

A.1 INTRODUCTION

This appendix contains the following schematics and layouts for the MTS2916A Dual Full-Bridge Stepper Motor Driver Evaluation Board:

- Board – Schematic
- Board – Top Silk
- Board – Top Pads and Silk
- Board – Bottom Copper

A.3 BOARD – TOP SILK

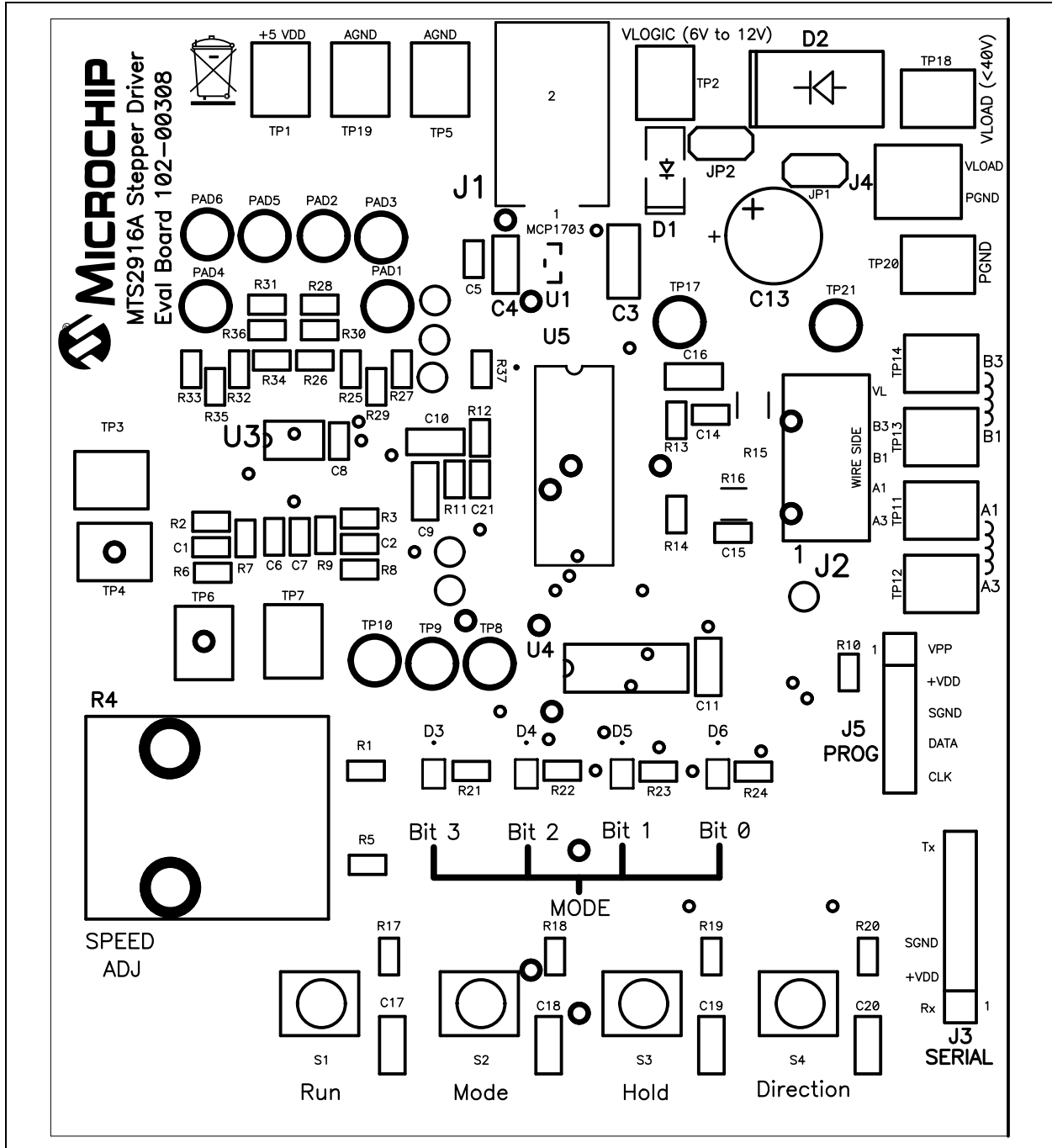

A.5 BOARD – BOTTOM COPPER

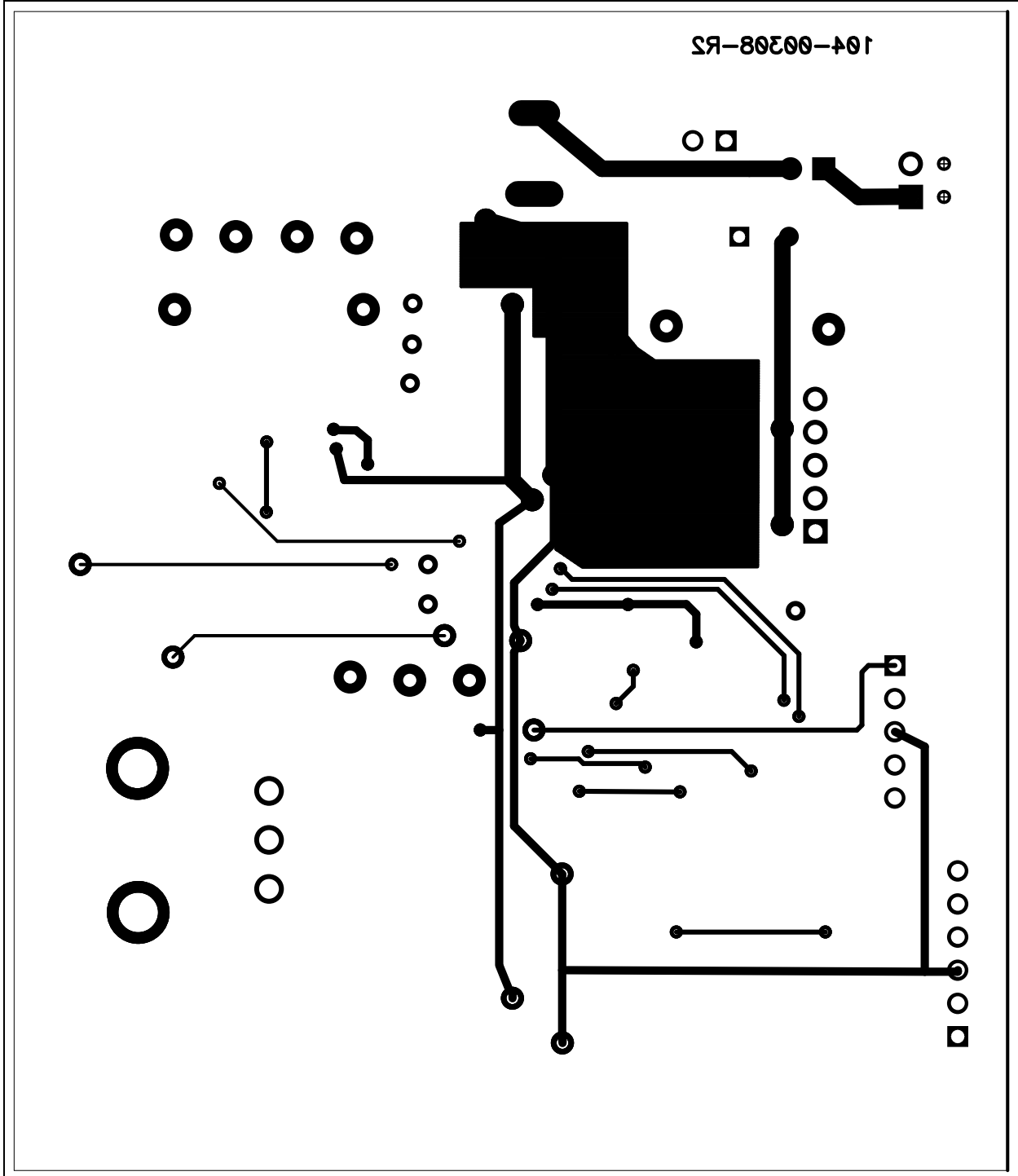

NOTES:



MTS2916A DUAL FULL-BRIDGE STEPPER MOTOR DRIVER EVALUATION BOARD USER'S GUIDE

Appendix B. Bill of Materials

TABLE B-1: BILL OF MATERIALS

Qty.	Reference	Description	Manufacturer	Part Number
2	C1, C2	Cap. 0.22 μ F 10V Ceramic X7R 0603 10%	Yageo Corporation	CC0603KRX7R6BB224
1	C3	Cap. 1.0 μ F 50V Ceramic X7R 10% 1206	TDK Corporation	C3216X7R1H105K
6	C4, C11, C17, C18, C19, C20	Cap. 1.0 μ F 10V Ceramic X7R 0805 10%	Murata Manufacturing Co., Ltd.	GRM21BR71A105KA01L
1	C5	Cap. 0.01 μ F 50V Ceramic X7R 0603 10%	Murata Manufacturing Co., Ltd.	GRM188R71H103KA01D
4	C6, C7, C8, C21	Cap. 0.1 μ F 25V Ceramic X7R 0603 10%	Murata Manufacturing Co., Ltd.	GRM188R71E104KA01D
1	C13	Cap. 100 μ F 50V Elect. EB Radial	Panasonic [®] – ECG	EEU-EB1H101S
4	C9, C10, C14, C15	Cap. 0.001 μ F 50V Ceramic X7R 0603 10%	Murata Manufacturing Co., Ltd.	GRM188R71H102KA01D
1	C16	Cap. 0.1 μ F 50V Ceramic X7R 0805 10%	Murata Manufacturing Co., Ltd.	GRM21BR71H104KA01L
1	D1	Diode Rectifier, Standard Recovery 1A 50V DO-214AC SMA	Vishay/General Semiconductor	S1A-E3
1	D2	Diode Rectifier, Standard Recovery 3A 200V DO-214AB SMC	Vishay/General Semiconductor	S3D-E3/57T
4	D3, D4, D5, D6	LED Chipped 570 nm Green 0805 SMD	OSRAM Opto Semiconductors GmbH.	LG R971-KN-1-0-20-R18
1	J1	Connector Pwr. Jack 2.5 X 6.5 mm W/O SW	CUI Inc.	PJ-037B
1	J2	Connector Term. Block 2.54 mm 5 Pos.	Phoenix Contact GmbH & Co.	1725685
1	J3	Connector Header 6 Pos. 0.100 Vert. Tin Breakaway	Molex [®]	—
1	J4	Connector Term. Block 2.54 mm 2 Pos.	Phoenix Contact GmbH & Co.	1725656
1	J5	Connector Header 5 Pos. 0.100 Vert. Tin Breakaway	Molex	—
1	JP1	Wire Jumper 22 Gauge	—	—
1	JP2	Connector Header 36 Pos. 0.100 Vert. Tin (36 cuts in pairs of 2 = 18 per part number)	Molex	22-28-4360
1	PCB	MTS2916A Dual Full-Bridge Stepper Motor Driver Evaluation Board Printed Circuit Board	Microchip Technology Inc.	104-00308
2	R1, R5	Res. 1K Ohm 1/10W 1% 0603 SMD	Stackpole Electronics, Inc.	RMCF0603FT1K00
2	R2, R3	Res. 22.6K Ohm 1/10W 1% 0603 SMD	Stackpole Electronics, Inc.	RMCF0603FT22K6
1	R4	Pot. 10K Ohm 1/8W Carb. Vertical	CTS [®] Corporation	296UD103B1N

Note 1: The components listed in this Bill of Materials are representative of the PCB assembly. The released BOM used in manufacturing uses all RoHS-compliant components.

MTS2916A Dual Full-Bridge Stepper Motor Driver Evaluation Board User's Guide

TABLE B-1: BILL OF MATERIALS (CONTINUED)

Qty.	Reference	Description	Manufacturer	Part Number
4	R6, R7, R8, R9	Res. 11.3K Ohm 1/10W 1% 0603 SMD	Stackpole Electronics, Inc.	RMCF0603FT11K3
1	R10	Res. 10K Ohm 1/10W 1% 0603 SMD	Stackpole Electronics, Inc.	RMCF0603FT10K0
2	R11, R12	Res. 22K Ohm 1/10W 1% 0603 SMD	Stackpole Electronics, Inc.	RMCF0603FT22K0
2	R13, R14	Res. 2K Ohm 1/10W 1% 0603 SMD	Stackpole Electronics, Inc.	RMCF0603FT2K00
2	R15, R16	Res. 1.00 Ohm 3/4W 1% 2010 SMD	Vishay/Dale	CRCW20101R00FKEF
4	R17, R18, R19, R20	Res. 49.9K Ohm 1/10W 1% 0603 SMD	Stackpole Electronics, Inc.	RMCF0603FT49K9
4	R21, R22, R23, R24	Res. 499 Ohm 1/10W 1% 0603 SMD	Stackpole Electronics, Inc.	RMCF0603FT499
4	R25, R30, R32, R36	Res. 0.0 Ohm 1/10W 5% 0603 SMD	Yageo Corporation	RC0603JR-070RL
1	R37	Res. 33K Ohm 1/10W 1% 0603 SMD	Stackpole Electronics, Inc.	RMCF0603FT33K0
4	S1, S2, S3, S4	Switch Tactile SPST-NO 6 mm 260 GF 0.05A 12V SMT	E-Switch [®] , Inc.	TL3301NF260QG
14	TP1, TP2, TP3, TP4, TP5, TP6, TP7, TP11, TP12, TP13, TP14, TP18, TP19, TP20	Test Point PC Compact SMT	Keystone Electronics Corp.	5016
1	U1	Microchip 5V 250 mA LDO SOT-23A	Microchip Technology Inc.	MCP1703T-5002E/CB
1	U3	MCP6024 General Purpose Op Amp 14-TSSOP	Microchip Technology Inc.	MCP6024-E/ST
1	U5	MTS2916A IC PWM Stepper Motor Driver 24-SOP	Microchip Technology Inc.	MTS2916A-HGC1
1	U4	PIC16F883 MCU Flash 4K X 14 28-SSOP	Microchip Technology Inc.	PIC16F883-E/SS

Note 1: The components listed in this Bill of Materials are representative of the PCB assembly. The released BOM used in manufacturing uses all RoHS-compliant components.



MICROCHIP

MTS2916A DUAL FULL-BRIDGE STEPPER MOTOR DRIVER EVALUATION BOARD USER'S GUIDE

Appendix C. Mode Sequence Diagrams

C.1 MTS2916A DUAL FULL-BRIDGE STEPPER MOTOR DRIVER EVALUATION BOARD FUNCTIONAL FLOWCHART

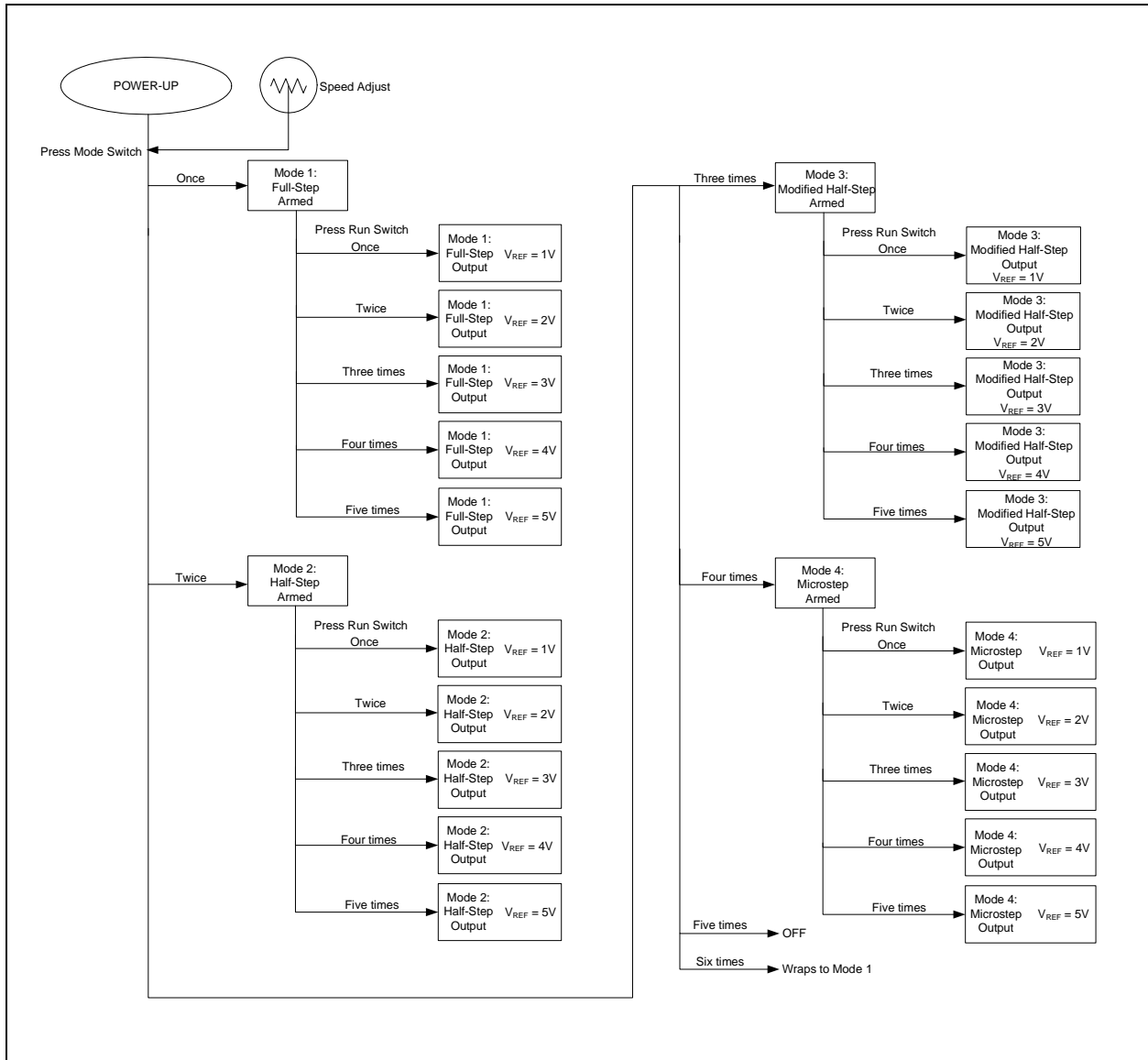

C.2 SINGLE STEPPING EXAMPLE

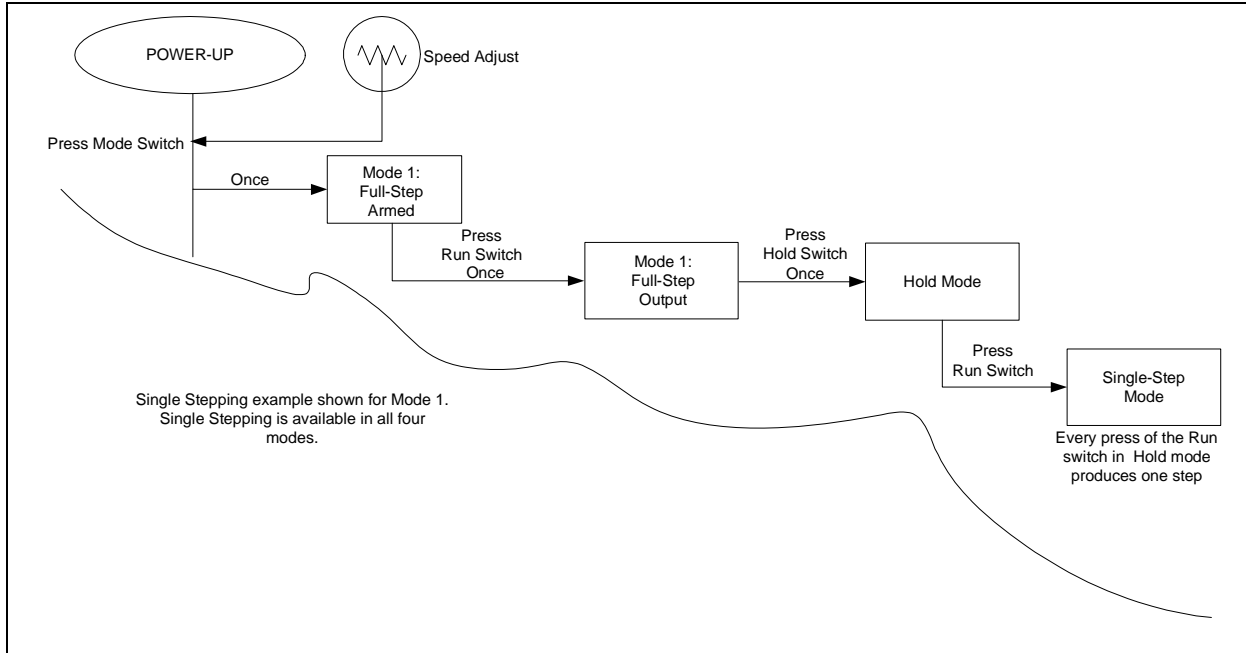

Mode Sequence Diagrams

C.3 MTS2916A DUAL FULL-BRIDGE STEPPER MOTOR DRIVER EVALUATION BOARD SOFTWARE FLOWCHARTS

C.3.1 Main() Mode

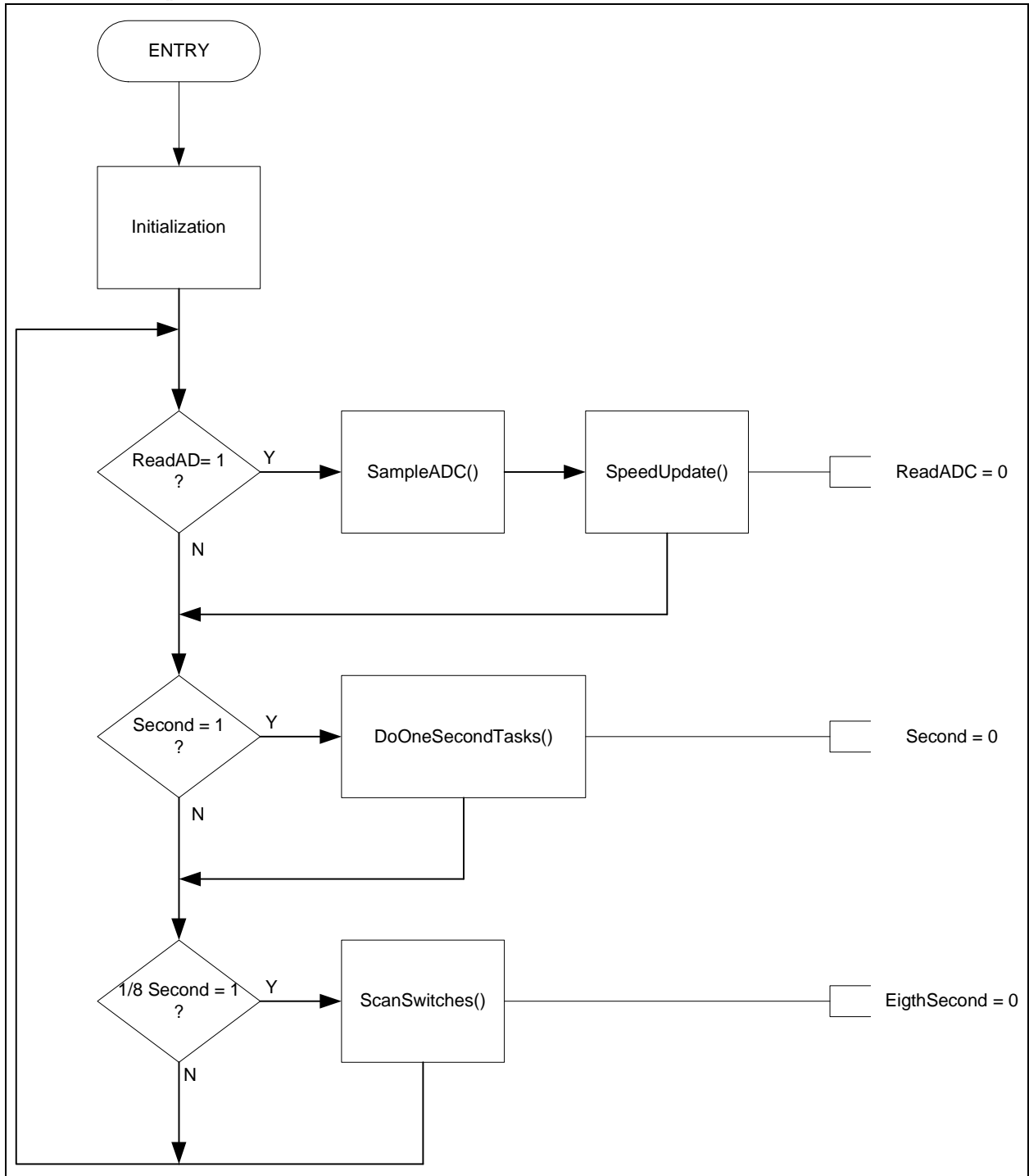

C.3.2 Interrupt() Mode

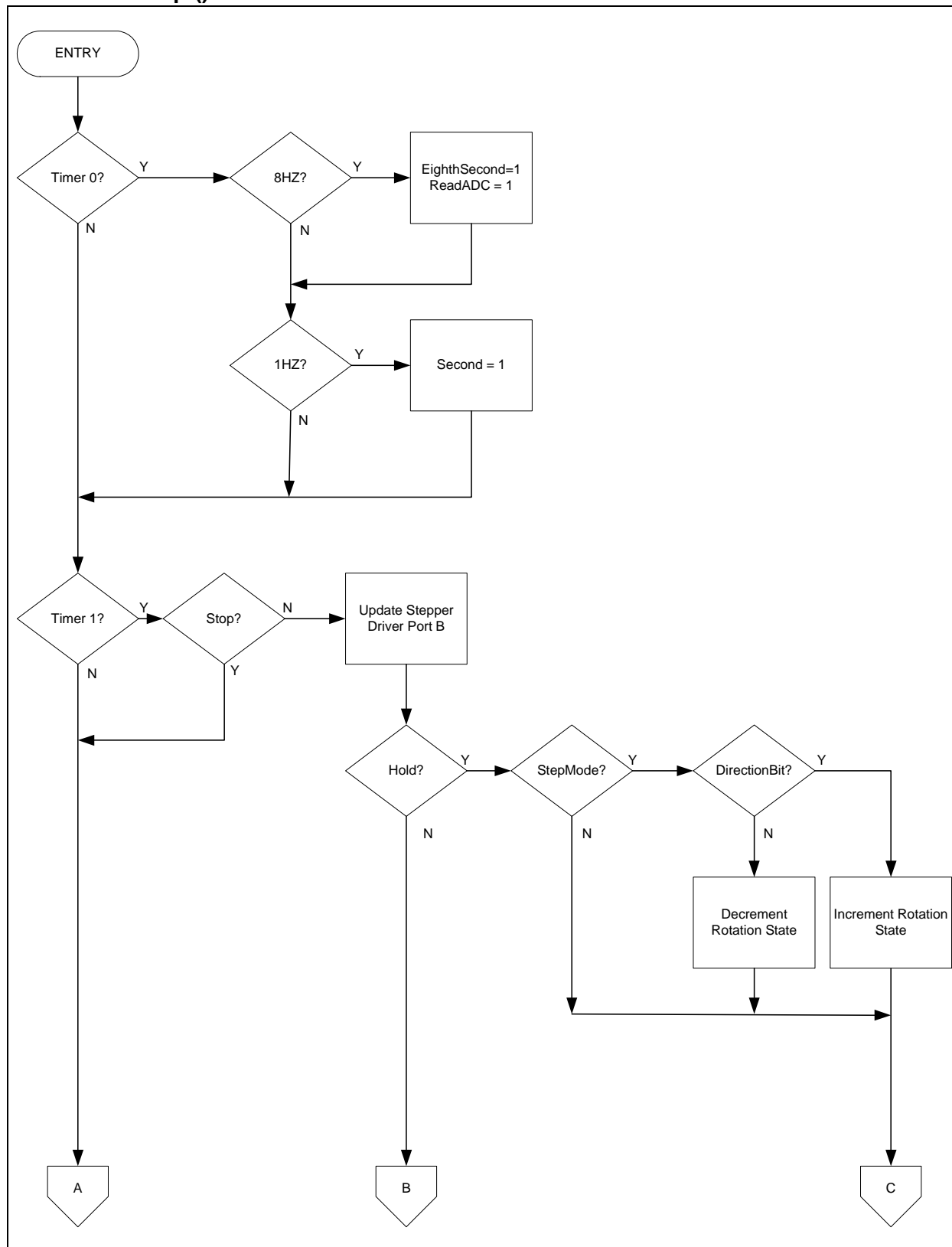

FIGURE C-1: Interrupt() Mode.

Mode Sequence Diagrams

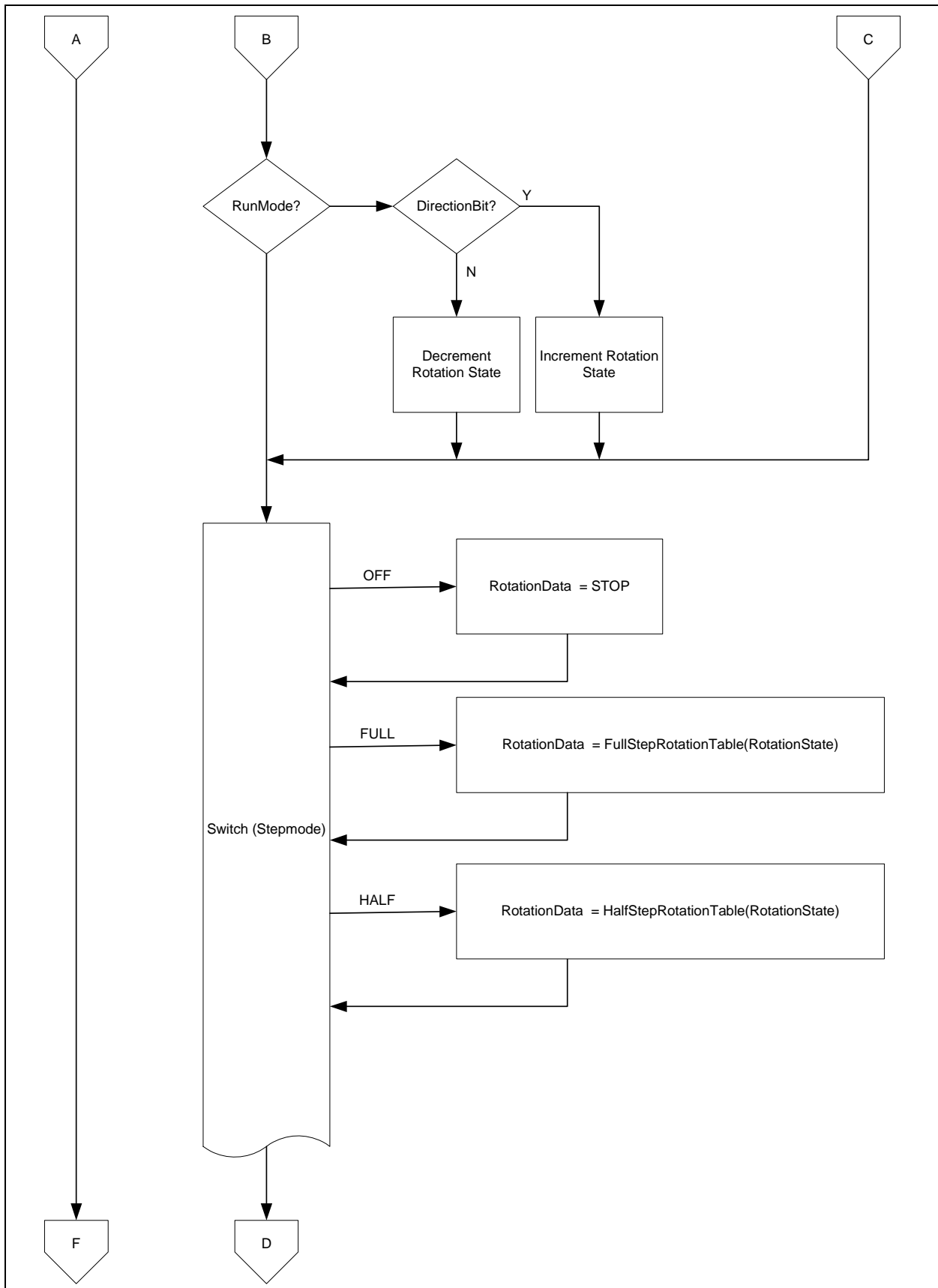

FIGURE C-2: Interrupt Mode (Continuation).

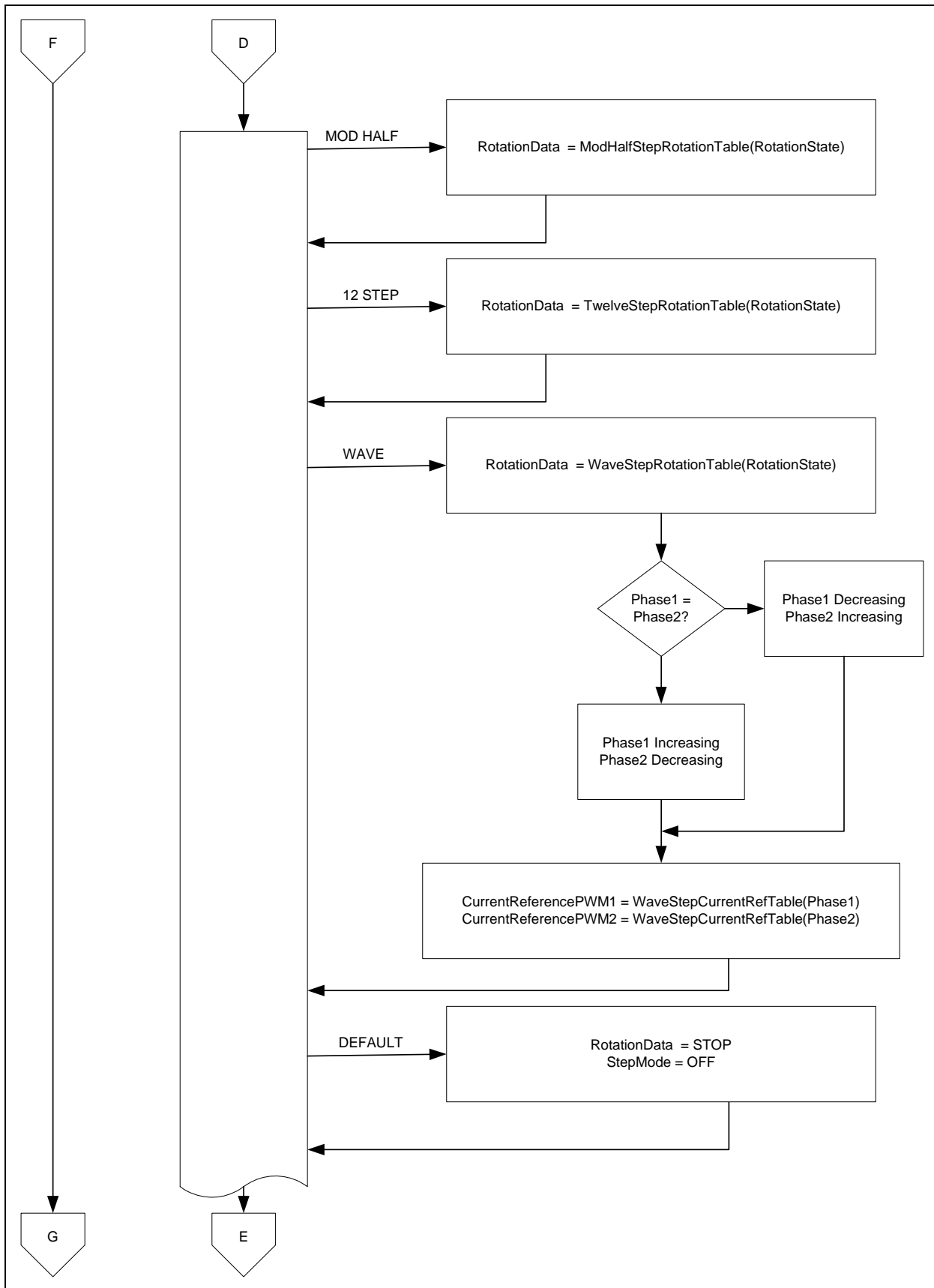

FIGURE C-3: Interrupt Mode (Continuation).

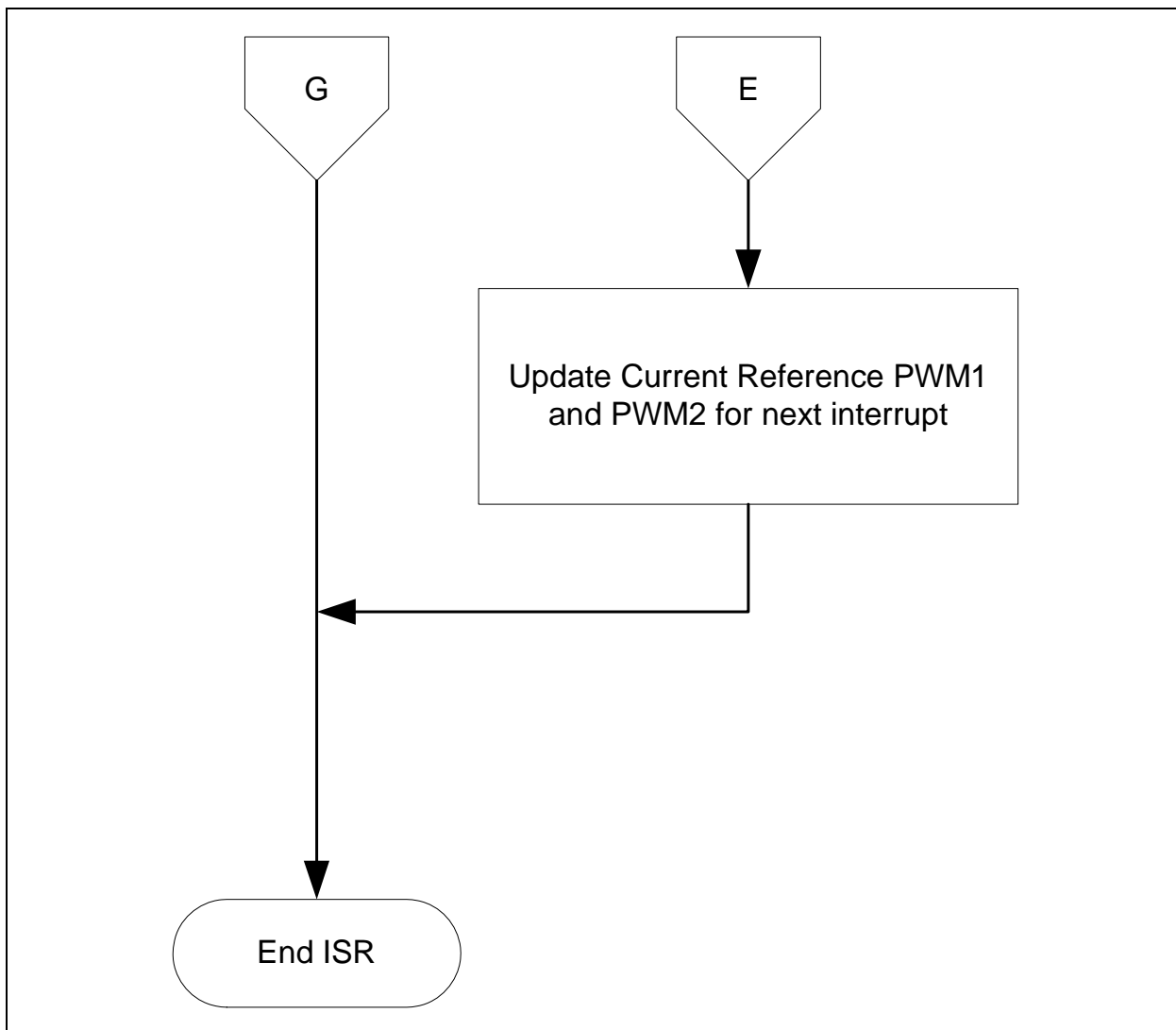
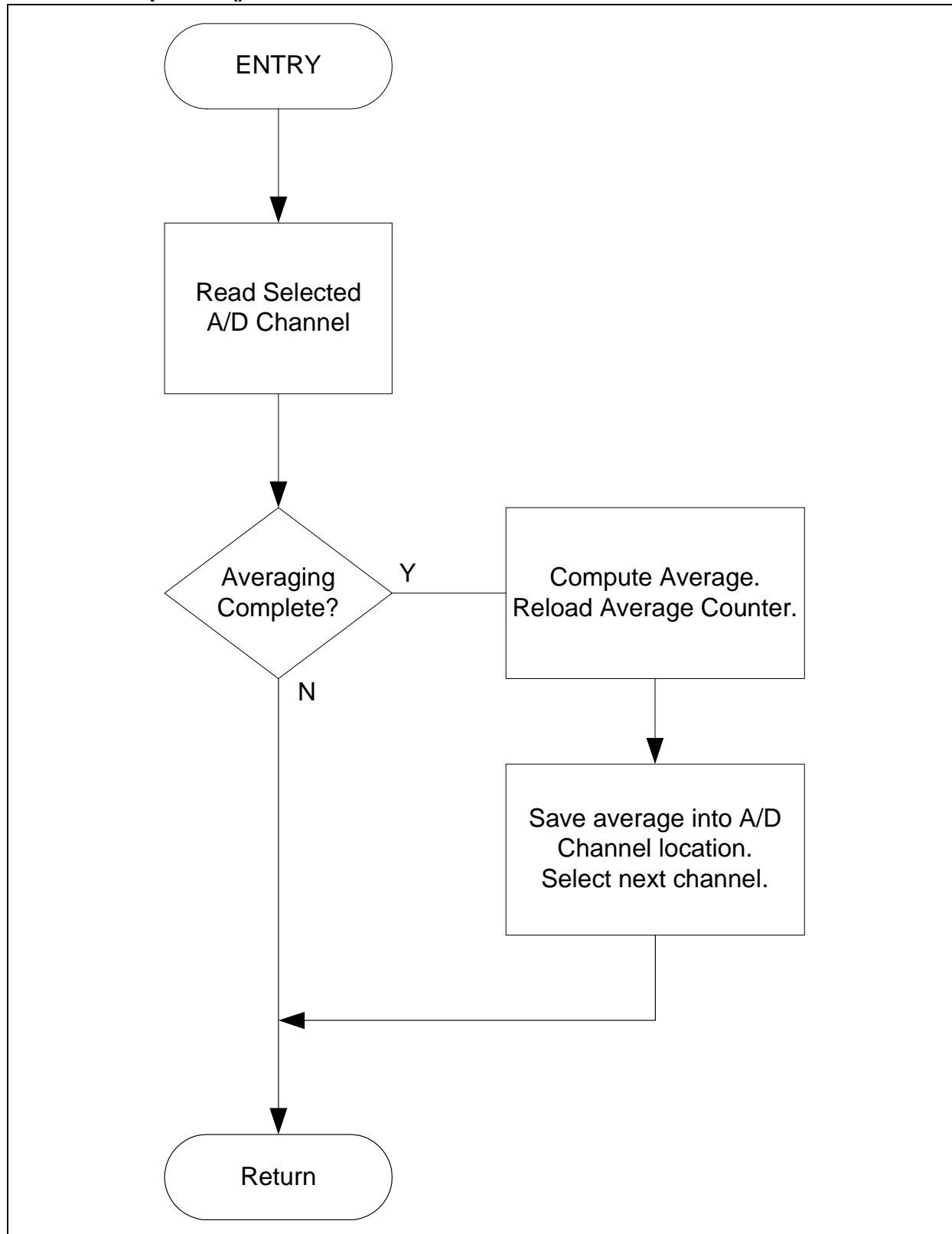
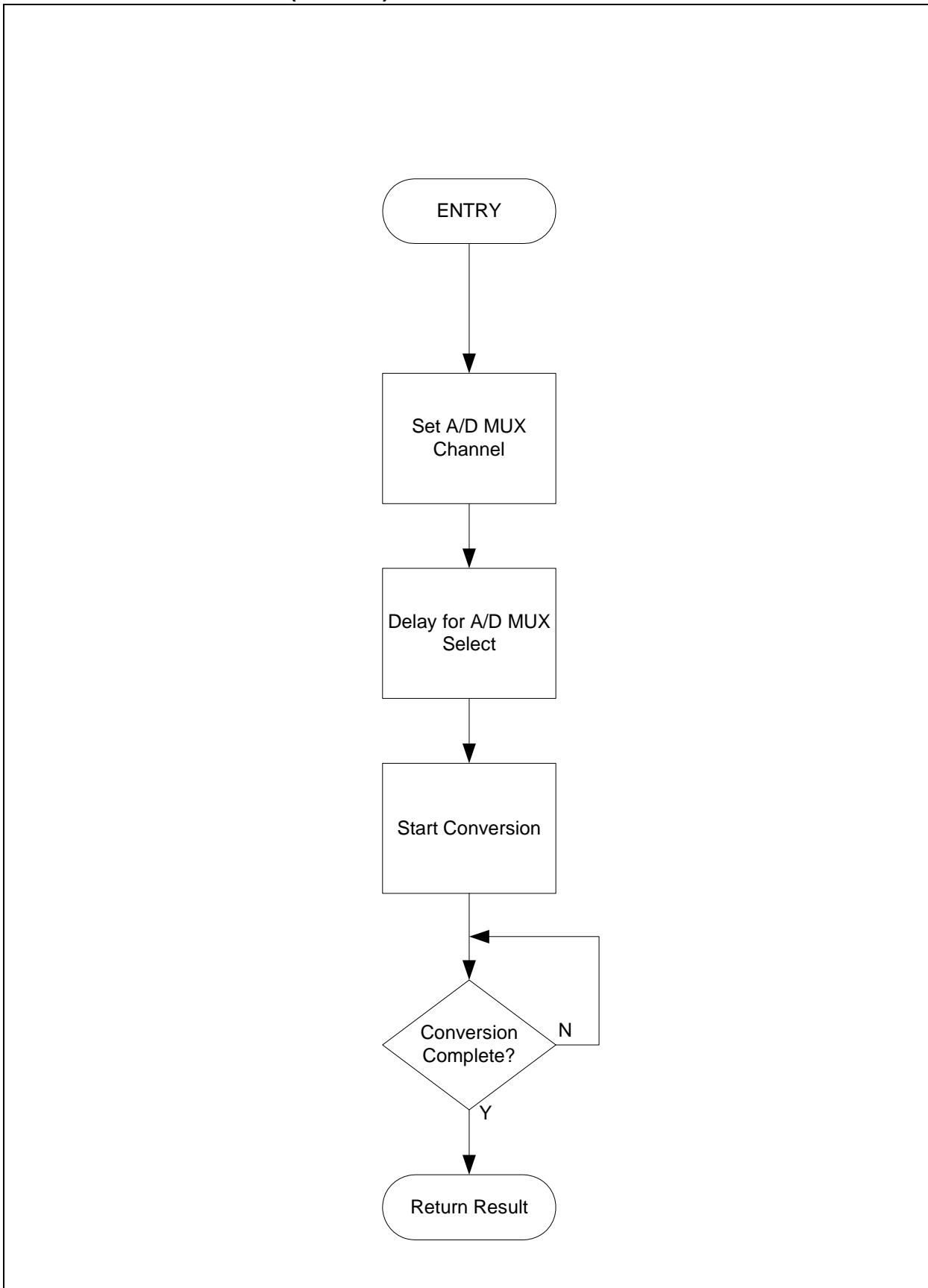

FIGURE C-4: *Interrupt Mode (Last).*

C.3.3 SampleADC() Mode



C.3.4 ReadADCChannel (Channel) Mode



C.3.5 SpeedUpdate() Mode

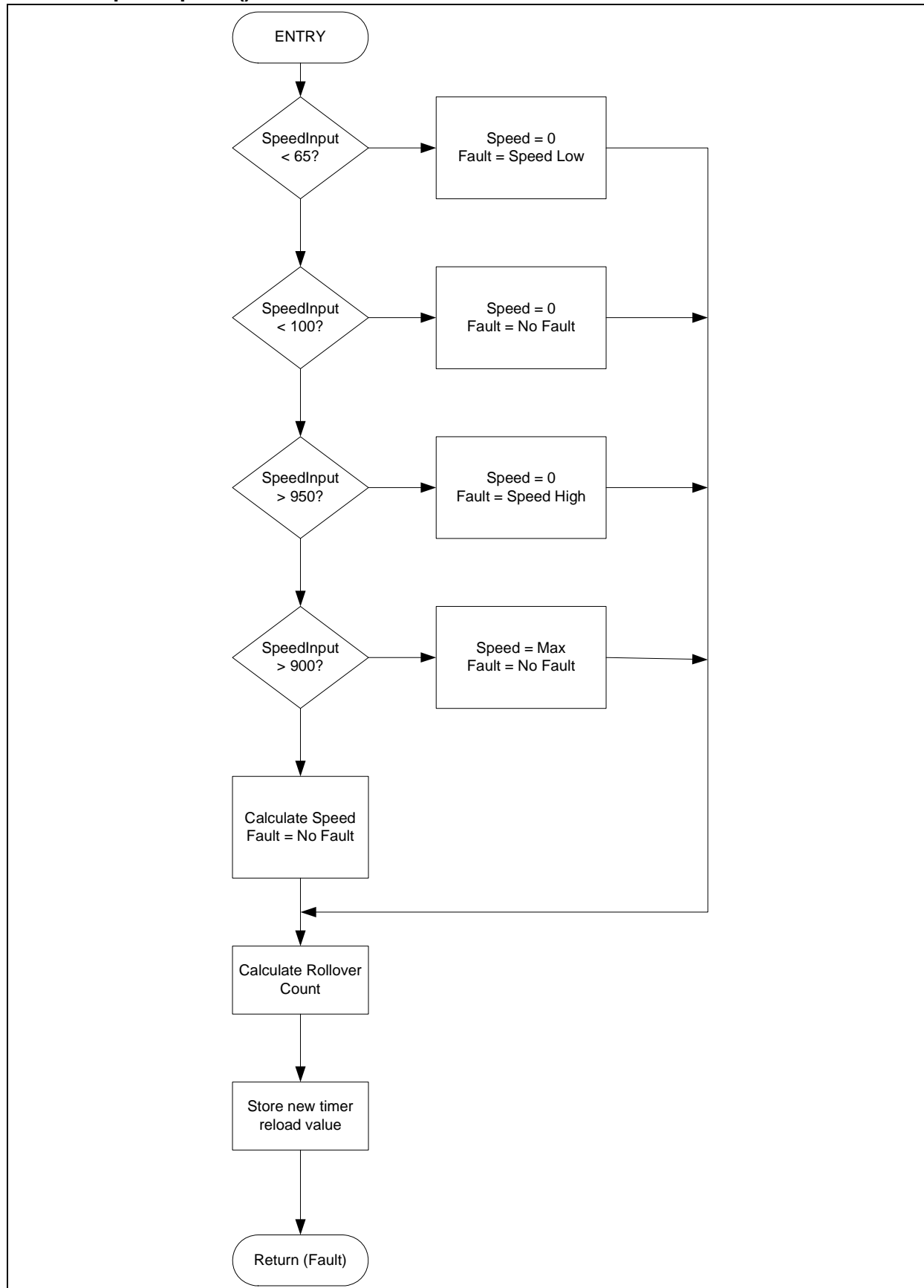

C.3.6 DoOneSecondTasks() Mode

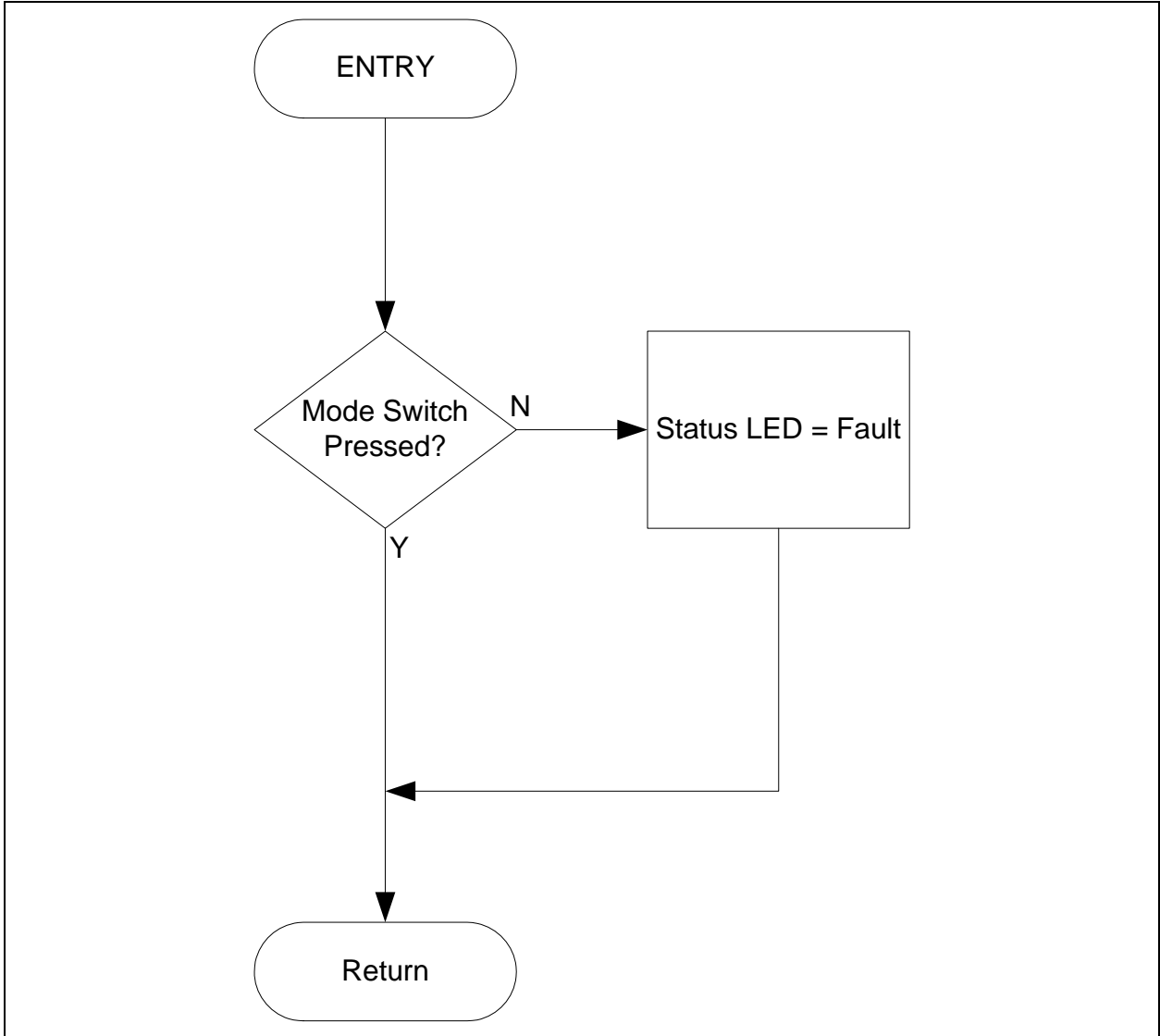

C.3.7 ScanSwitches() Mode

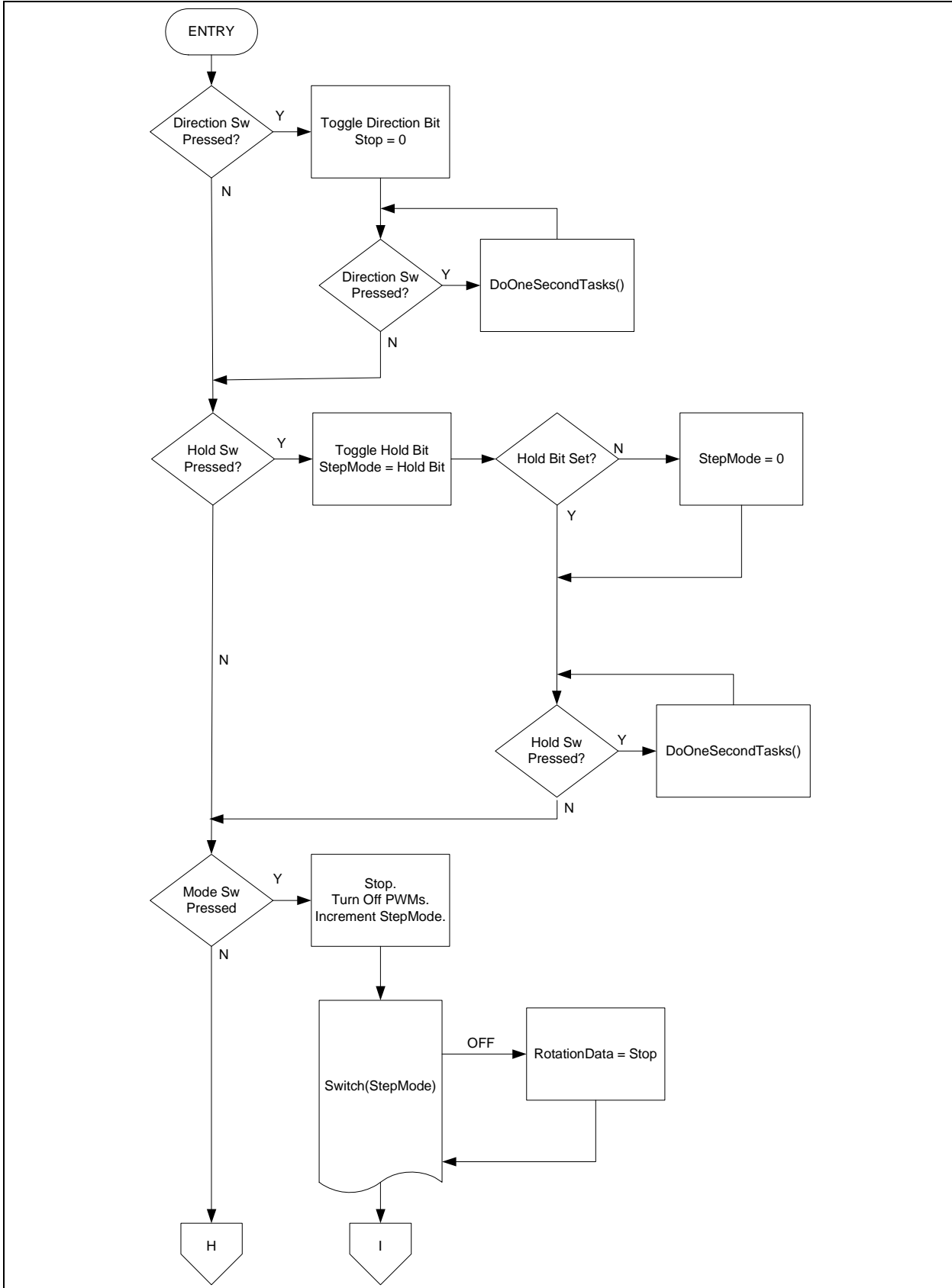

FIGURE C-5: ScanSwitches() Mode.

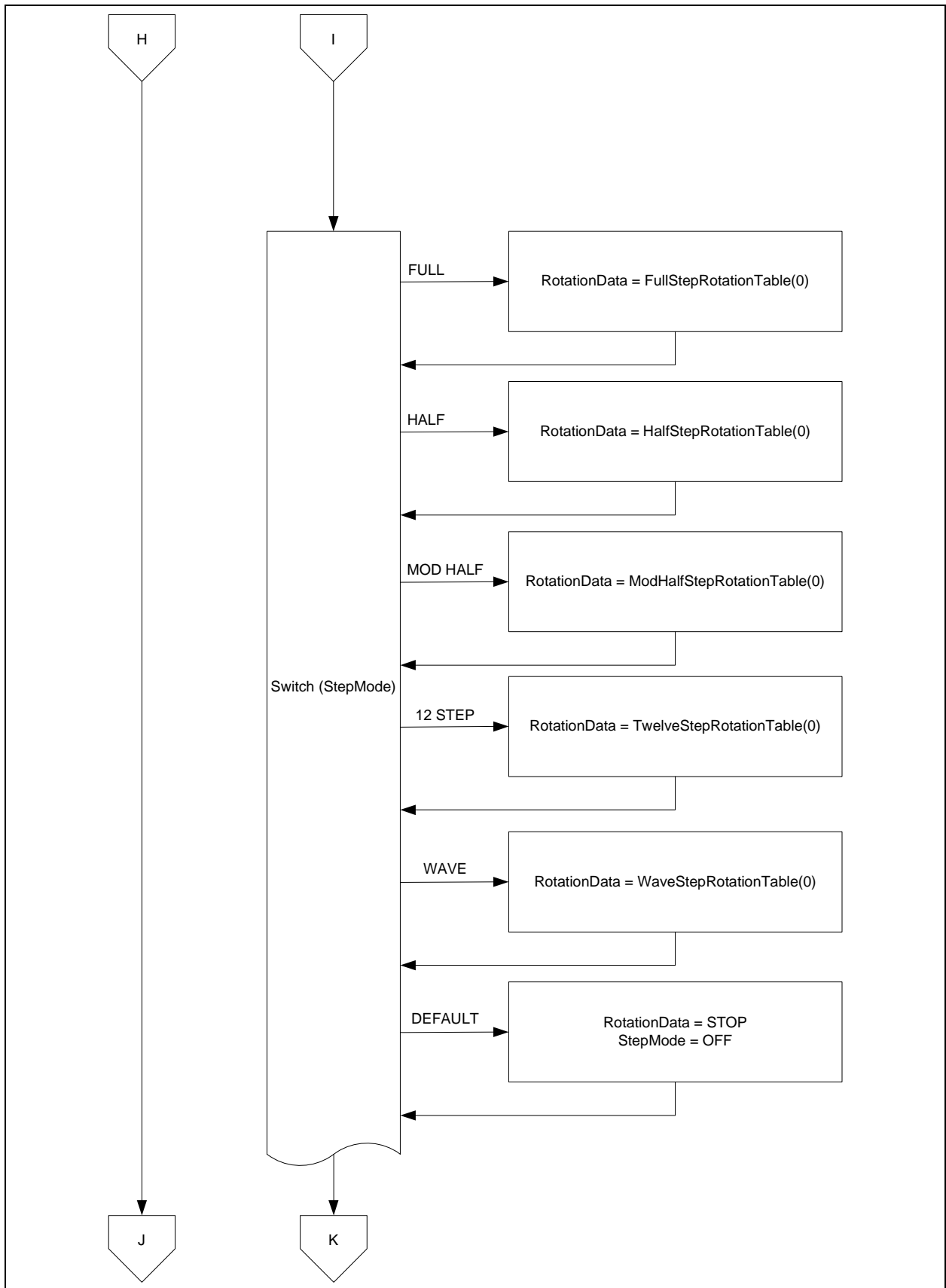

FIGURE C-6: *ScanSwitches() Mode (Continuation).*

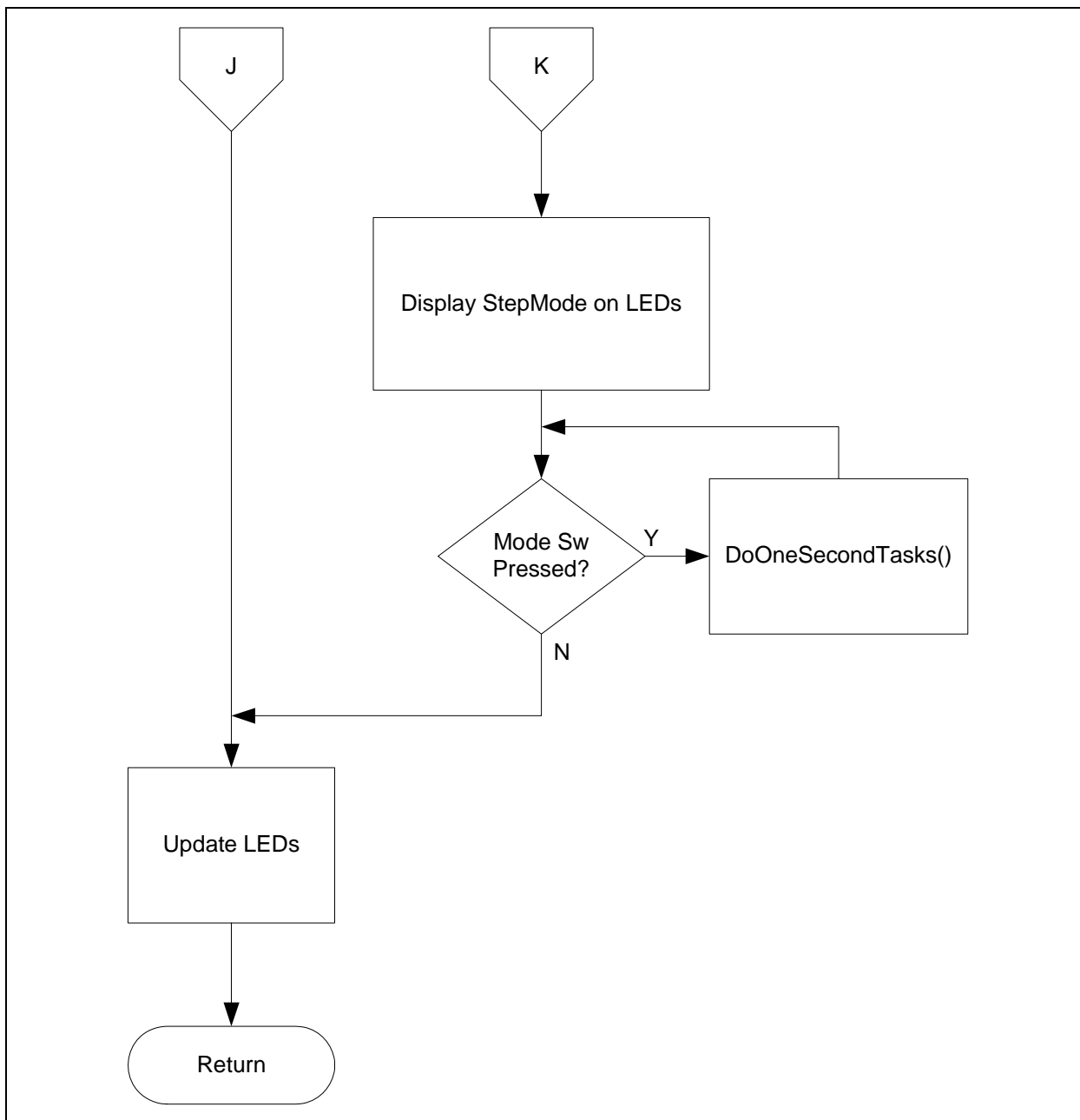

FIGURE C-7: ScanSwitches() Mode (Continuation).

NOTES:



MICROCHIP

Worldwide Sales and Service

AMERICAS

Corporate Office
2355 West Chandler Blvd.
Chandler, AZ 85224-6199
Tel: 480-792-7200
Fax: 480-792-7277
Technical Support:
<http://www.microchip.com/support>
Web Address:
www.microchip.com

Atlanta
Duluth, GA
Tel: 678-957-9614
Fax: 678-957-1455

Boston
Westborough, MA
Tel: 774-760-0087
Fax: 774-760-0088

Chicago
Itasca, IL
Tel: 630-285-0071
Fax: 630-285-0075

Cleveland
Independence, OH
Tel: 216-447-0464
Fax: 216-447-0643

Dallas
Addison, TX
Tel: 972-818-7423
Fax: 972-818-2924

Detroit
Farmington Hills, MI
Tel: 248-538-2250
Fax: 248-538-2260

Indianapolis
Noblesville, IN
Tel: 317-773-8323
Fax: 317-773-5453

Los Angeles
Mission Viejo, CA
Tel: 949-462-9523
Fax: 949-462-9608

Santa Clara
Santa Clara, CA
Tel: 408-961-6444
Fax: 408-961-6445

Toronto
Mississauga, Ontario,
Canada
Tel: 905-673-0699
Fax: 905-673-6509

ASIA/PACIFIC

Asia Pacific Office
Suites 3707-14, 37th Floor
Tower 6, The Gateway
Harbour City, Kowloon
Hong Kong
Tel: 852-2401-1200
Fax: 852-2401-3431

Australia - Sydney
Tel: 61-2-9868-6733
Fax: 61-2-9868-6755

China - Beijing
Tel: 86-10-8569-7000
Fax: 86-10-8528-2104

China - Chengdu
Tel: 86-28-8665-5511
Fax: 86-28-8665-7889

China - Chongqing
Tel: 86-23-8980-9588
Fax: 86-23-8980-9500

China - Hangzhou
Tel: 86-571-2819-3187
Fax: 86-571-2819-3189

China - Hong Kong SAR
Tel: 852-2943-5100
Fax: 852-2401-3431

China - Nanjing
Tel: 86-25-8473-2460
Fax: 86-25-8473-2470

China - Qingdao
Tel: 86-532-8502-7355
Fax: 86-532-8502-7205

China - Shanghai
Tel: 86-21-5407-5533
Fax: 86-21-5407-5066

China - Shenyang
Tel: 86-24-2334-2829
Fax: 86-24-2334-2393

China - Shenzhen
Tel: 86-755-8864-2200
Fax: 86-755-8203-1760

China - Wuhan
Tel: 86-27-5980-5300
Fax: 86-27-5980-5118

China - Xian
Tel: 86-29-8833-7252
Fax: 86-29-8833-7256

China - Xiamen
Tel: 86-592-2388138
Fax: 86-592-2388130

China - Zhuhai
Tel: 86-756-3210040
Fax: 86-756-3210049

ASIA/PACIFIC

India - Bangalore
Tel: 91-80-3090-4444
Fax: 91-80-3090-4123

India - New Delhi
Tel: 91-11-4160-8631
Fax: 91-11-4160-8632

India - Pune
Tel: 91-20-2566-1512
Fax: 91-20-2566-1513

Japan - Osaka
Tel: 81-6-6152-7160
Fax: 81-6-6152-9310

Japan - Tokyo
Tel: 81-3-6880-3770
Fax: 81-3-6880-3771

Korea - Daegu
Tel: 82-53-744-4301
Fax: 82-53-744-4302

Korea - Seoul
Tel: 82-2-554-7200
Fax: 82-2-558-5932 or
82-2-558-5934

Malaysia - Kuala Lumpur
Tel: 60-3-6201-9857
Fax: 60-3-6201-9859

Malaysia - Penang
Tel: 60-4-227-8870
Fax: 60-4-227-4068

Philippines - Manila
Tel: 63-2-634-9065
Fax: 63-2-634-9069

Singapore
Tel: 65-6334-8870
Fax: 65-6334-8850

Taiwan - Hsin Chu
Tel: 886-3-5778-366
Fax: 886-3-5770-955

Taiwan - Kaohsiung
Tel: 886-7-213-7828
Fax: 886-7-330-9305

Taiwan - Taipei
Tel: 886-2-2508-8600
Fax: 886-2-2508-0102

Thailand - Bangkok
Tel: 66-2-694-1351
Fax: 66-2-694-1350

EUROPE

Austria - Wels
Tel: 43-7242-2244-39
Fax: 43-7242-2244-393

Denmark - Copenhagen
Tel: 45-4450-2828
Fax: 45-4485-2829

France - Paris
Tel: 33-1-69-53-63-20
Fax: 33-1-69-30-90-79

Germany - Munich
Tel: 49-89-627-144-0
Fax: 49-89-627-144-44

Italy - Milan
Tel: 39-0331-742611
Fax: 39-0331-466781

Netherlands - Drunen
Tel: 31-416-690399
Fax: 31-416-690340

Spain - Madrid
Tel: 34-91-708-08-90
Fax: 34-91-708-08-91

UK - Wokingham
Tel: 44-118-921-5869
Fax: 44-118-921-5820

11/29/12