

SITOR FUSE LINKS 25A, AC 690V (DIN 43620, SIZE 00)



Figure similar

Model		
product brand name		SETRON
Design of an identification indicator		front indicator
Design of the fuse link		SITOR, LV HRC design
General technical data		
Size of fuse system / acc. to DIN EN 60269-1		NH00
Operating class of the fuse link		gR
circuit-breaker / Design		3NE
Varying load factor (WL)		0.95
Supply voltage / at DC	V	440
Switching capacity		
Switching capacity current		
<ul style="list-style-type: none"> acc. to IEC 60947-2 / rated value 	kA	100
Dissipation		
Power loss [W]		
<ul style="list-style-type: none"> for rated value of the current / at AC / in hot operating state / per pole 	W	7
<ul style="list-style-type: none"> maximum 	W	7

Electricity

rated current I _n / IEC, DIN/VDE / at 40 Cel	A	25
Current / at AC / rated value	A	25

Mechanical Design

Mounting position		Any, preferably vertical
-------------------	--	--------------------------

Environmental conditions

Ambient temperature		
• minimum	°C	-20
• maximum	°C	50
Environmental category		-20 to +50 at 95% relative humidity

Certificates

Equipment marking		
• acc. to DIN EN 61346-2		F
• acc. to DIN EN 81346-2		F

General Product Approval	Declaration of Conformity	other
---------------------------------	----------------------------------	--------------



[sonstig](#)

Further information

Information- and Downloadcenter (Catalogs, Brochures,...)

<http://www.siemens.com/lowvoltage/catalogs>

Industry Mall (Online ordering system)

<https://eb.automation.siemens.com/mall/en/WW/Catalog/Product/3NE80151>

Service&Support (Manuals, Certificates, Characteristics, FAQs,...)

<http://support.automation.siemens.com/WW/view/en/3NE80151/all>

Image database (product images, 2D dimension drawings, 3D models, device circuit diagrams, ...)

http://www.automation.siemens.com/bilddb/cax_en.aspx?mlfb=3NE80151

CAX-Online-Generator

<http://www.siemens.com/cax>

Tender specifications

<http://ausschreibungstexte.siemens.com/tiplv>

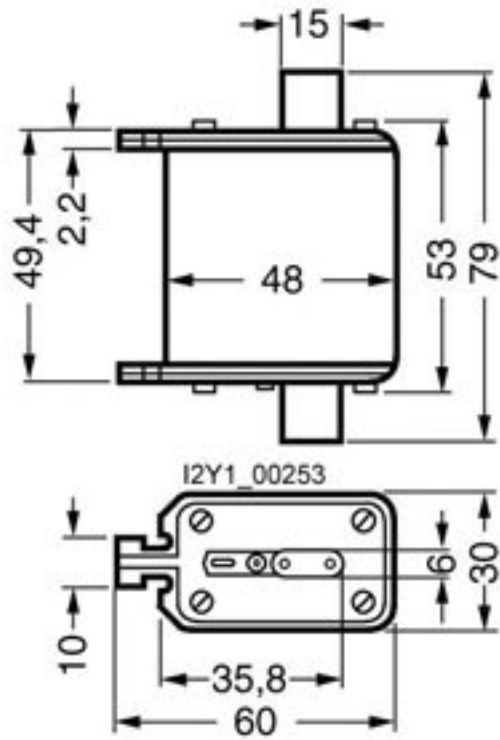

last modified:

12.04.2016