

2-conductor terminal strip; with fixing flanges; for screw or similar mounting types; fixing hole 3.2 mm Ø; 8-pole

Item No.: 264-108



2-conductor terminal strip; with fixing flanges; for screw or similar mounting types; fixing hole 3.2 mm Ø; 8-pole

Marking

RoHS ✓
Compliant

Business data

Supplier	WAGO
Item no.	264-108
GTIN / EAN	4044918425872
Content	1
Order amount	50
Customer item number	

Notes

Technical data

Miscellaneous

No. of poles	8
Total number of connection points	16
Total number of potentials	8
Color	gray
Pollution degree (1)	3
Rated voltage EN (1) [V]	800 [V]
Rated surge voltage (1) [kV]	8 [kV]
Nominal current [A]	24 [A]
Connection technology (1)	CAGE CLAMP®

Technical data	
<i>Solid sizes 1</i>	<i>0.08 ... 2.5 mm² / 28 ... 12 AWG</i>
<i>Fine-stranded wires 1</i>	<i>0.08 ... 2.5 mm² / 28 ... 12 AWG</i>
<i>Strip length 1</i>	<i>8 ... 9 mm / 0.31 ... 0.35 in</i>
<i>Note (conductor cross-section)</i>	<i>12 AWG: THHN, THWN</i>
<i>Type of wiring</i>	<i>Front-entry wiring</i>
<i>Design</i>	<i>horizontal</i>
<i>Marking level</i>	<i>Center marking</i>
<i>Fire load [MJ]</i>	<i>0.661 [MJ]</i>
<i>Weight [g]</i>	<i>35.6 [g]</i>
<i>Width</i>	<i>64 mm / 2.52 in</i>
<i>Height from the surface</i>	<i>22.1 mm / 0.87 in</i>
<i>Length</i>	<i>32 mm / 1.26 in</i>
<i>Module width [mm]</i>	<i>6 [mm]</i>
<i>Module width [inch] [inch]</i>	<i>0.236 [inch]</i>

Images & drawings

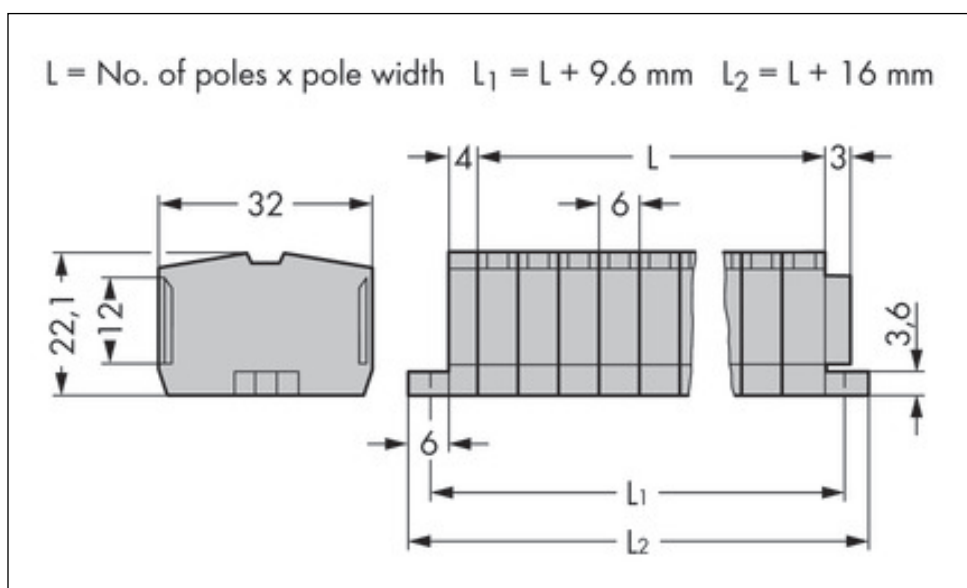
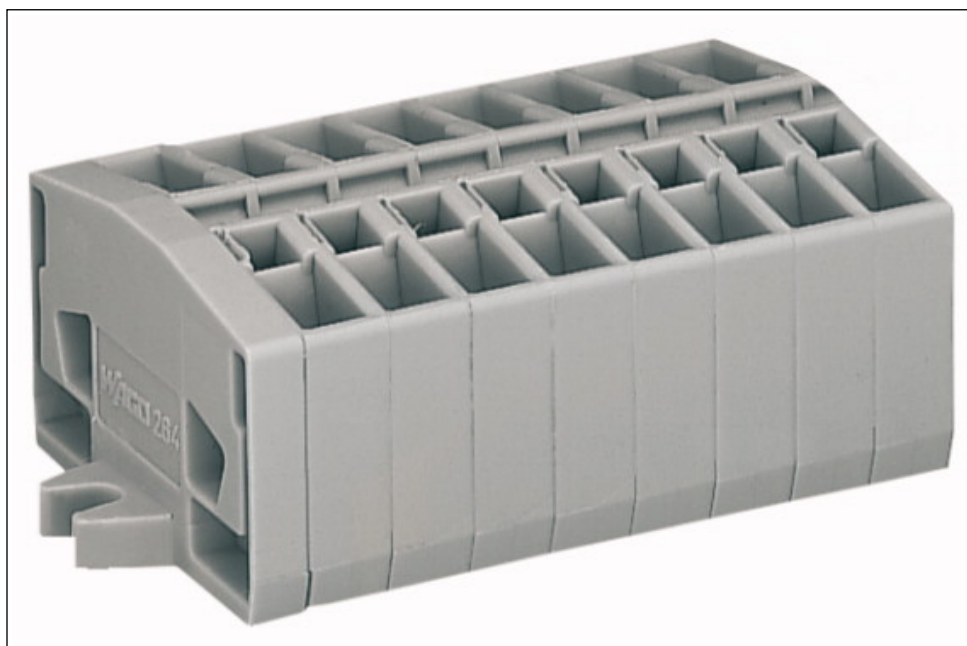

Address

WAGO Kontakttechnik GmbH & Co. KG

Hansastr. 27

32423 Minden

Telefon: 0571/887-0

Fax: 0571/887-169

<http://www.wago.com>

© WAGO Kontakttechnik GmbH & Co. KG

Technische Änderungen und Irrtümer vorbehalten.