

DTMSS-12 SENDUST POWER INDUCTORS



APPLICATIONS:

- interference suppressing chokes (DC - 300kHz)
- energy storage inductors (DC - 300kHz)
- DC/DC converters
- SMPS
- EMI filters (DC - 1 MHz)
- acoustic filters

ORDERING CODE:

DTMSS-12,5/0,33/0,17-V

mounting: V - vertical, H - horizontal, BV - base vertical,
CV - case vertical, CH - case horizontal
rated current in Amps
inductance in mH@ $I_{DC} = 0A$
sendust core outer diameter
product symbol

DIMENSIONS:

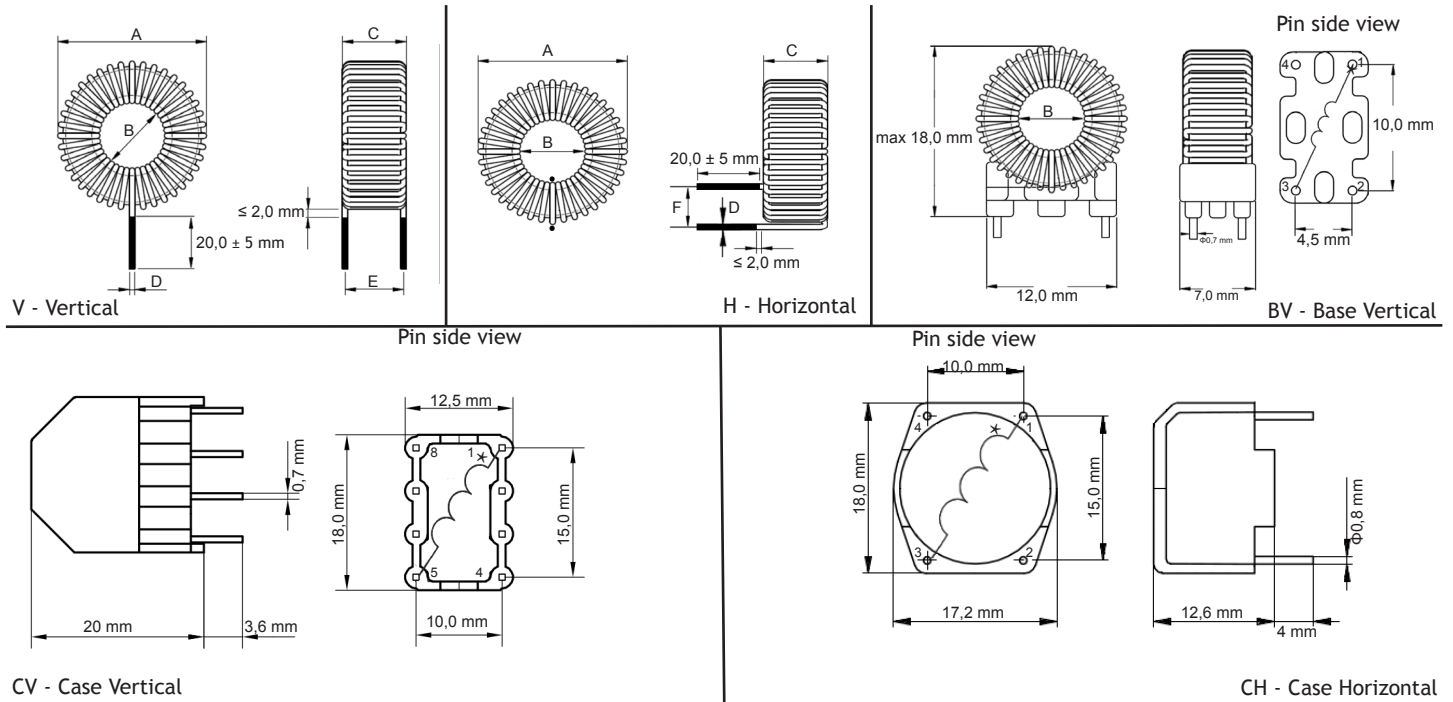

Part number	Dimensions ($\pm 10\%$)						Mounting version				
	A [mm]	B [mm]	C [mm]	D [mm]	E [mm]	F [mm]	V	H	BV	CV	CH
DTMSS-12,5/0,33/0,17	14,0	6,5	6,0	0,15	5,0	4,0	✓	✓	✓	✓	✓
DTMSS-12,5/0,22/0,25	14,0	6,5	6,0	0,18	5,0	4,0	✓	✓	✓	✓	✓
DTMSS-12,5/0,15/0,4	14,0	6,5	6,0	0,22	5,0	4,0	✓	✓	✓	✓	✓
DTMSS-12,5/0,10/0,7	15,0	6,0	6,5	0,30	5,0	4,0	✓	✓	✓	✓	✓
DTMSS-12,5/0,068/1,0	15,0	6,0	6,5	0,35	5,0	4,0	✓	✓	✓	✓	✓
DTMSS-12,5/0,047/1,2	15,0	6,0	6,5	0,40	5,0	4,0	✓	✓	✓	✓	✓
DTMSS-12,5/0,033/1,9	15,0	5,5	6,5	0,50	6,0	5,5	✓	✓	—	✓	✓
DTMSS-12,5/0,022/2,4	15,0	5,0	7,5	0,80	6,0	5,5	✓	✓	—	✓	✓
DTMSS-12,5/0,015/4,0	16,0	4,0	7,5	1,25	6,0	6,0	✓	✓	—	✓	✓
DTMSS-12,5/0,010/6,0	16,5	3,0	8,0	1,30	7,5	6,0	✓	✓	—	—	—
DTMSS-12,5/0,0068/8,0	16,5	2,5	8,5	1,80	7,5	6,0	✓	✓	—	—	—
DTMSS-12,5/0,0047/10	16,5	1,5	8,5	1,80	7,5	6,5	✓	✓	—	—	—
DTMSS-12,5/0,0033/15	17,0	1,0	8,5	2,40	7,5	7,0	✓	✓	—	—	—

ELECTRICAL PROPERTIES:

Part number	Lmax [μH]	Imax [A]	L@Imax [μH]	RDC [Ω]	Δt [°C]
DTMSS-12,5/0,33/0,17	330	0,17	329	2,02	7,7
DTMSS-12,5/0,22/0,25	220	0,25	214	1,01	8,2
DTMSS-12,5/0,15/0,4	150	0,40	144	0,527	10,4
DTMSS-12,5/0,1/0,7	100	0,70	94	0,269	12,4
DTMSS-12,5/0,068/1,0	68	1,00	64	0,140	12,9
DTMSS-12,5/0,047/1,2	47	1,20	43	0,101	14,9
DTMSS-12,5/0,033/1,9	33	1,90	29	0,0518	18,4
DTMSS-12,5/0,022/2,4	22	2,40	19	0,0371	18,6
DTMSS-12,5/0,015/4,0	15	4,00	12	0,0193	25,1
DTMSS-12,5/0,010/6,0	10	6,00	7,4	0,0139	33,8
DTMSS-12,5/0,0068/8,0	6,8	8,00	4,8	0,00722	30,8
DTMSS-12,5/0,0047/10	4,7	10,0	3,4	0,00520	32,0
DTMSS-12,5/0,0033/15	3,3	15,0	2,0	0,00271	34,0

CHARACTERISTICS:

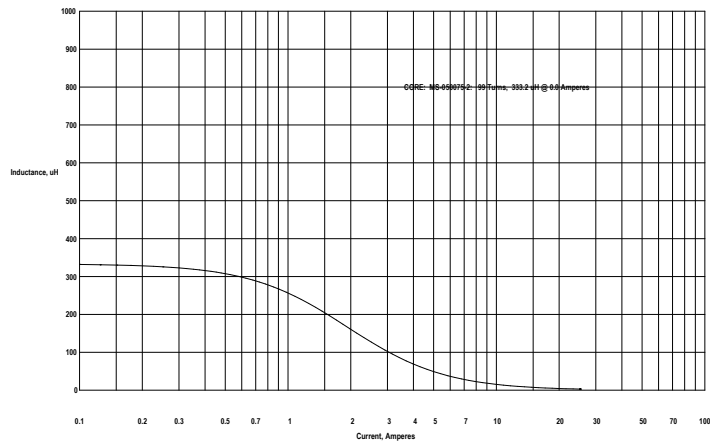

CREATED IN MICROMETALS ARNOLD POWDER CORES - DESIGN OF INDUCTORS FOR POWER FILTER APPLICATIONS Tue Nov 08 11:18:23 2011

DTMSS-12,5/0,33/0,17

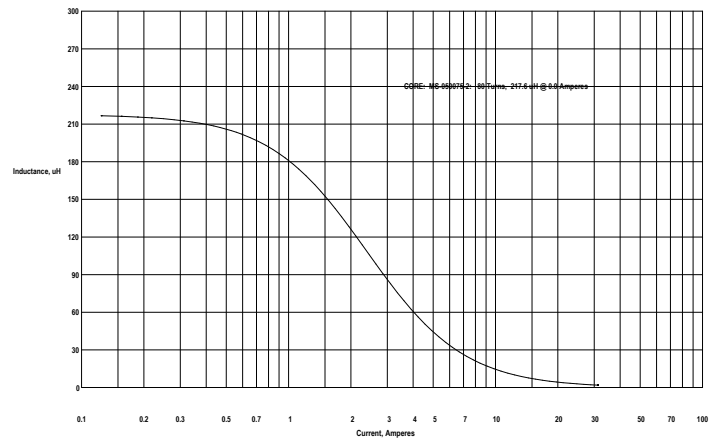

CREATED IN MICROMETALS ARNOLD POWDER CORES - DESIGN OF INDUCTORS FOR POWER FILTER APPLICATIONS Tue Nov 08 11:22:53 2011

DTMSS-12,5/0,22/0,25

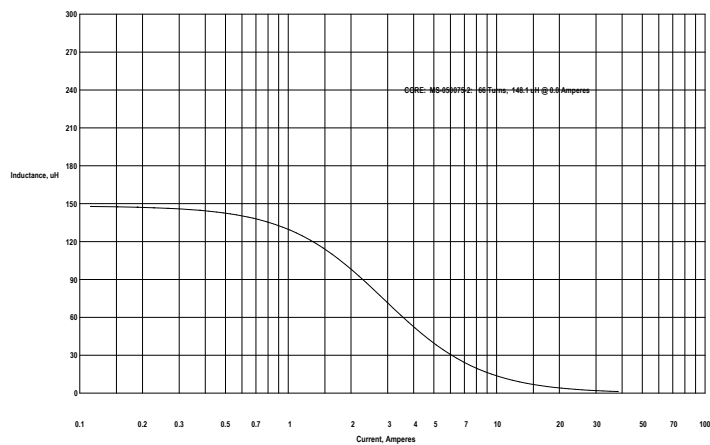

CREATED IN MICROMETALS ARNOLD POWDER CORES - DESIGN OF INDUCTORS FOR POWER FILTER APPLICATIONS Tue Nov 08 11:25:43 2011

DTMSS-12,5/0,15/0,4

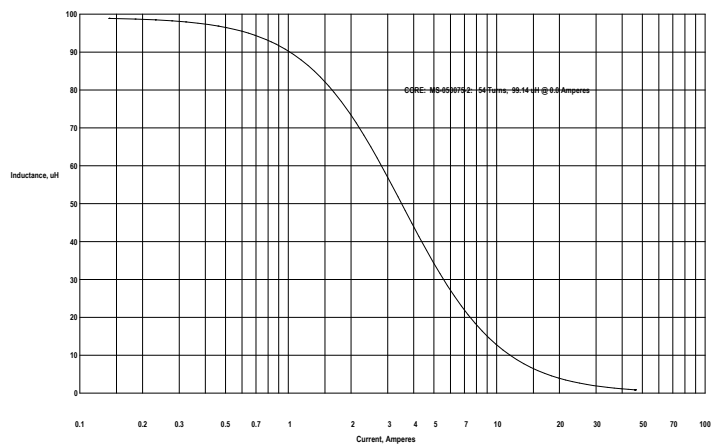

CREATED IN MICROMETALS ARNOLD POWDER CORES - DESIGN OF INDUCTORS FOR POWER FILTER APPLICATIONS Fri Nov 18 08:17:09 2011

DTMSS-12,5/0,1/0,7

CHARACTERISTICS:

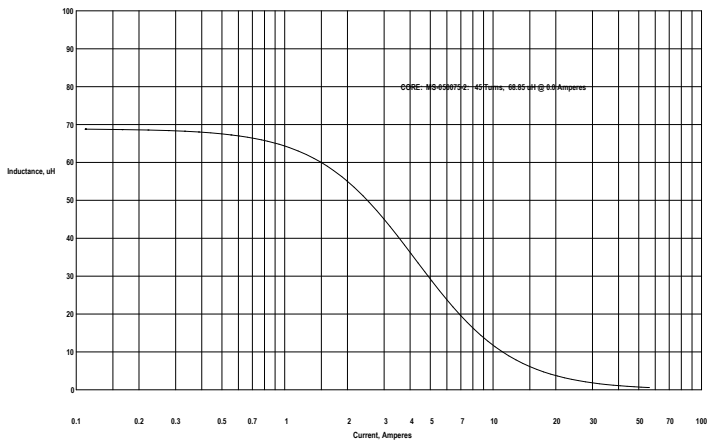

CREATED IN MICROMETALS ARNOLD POWDER CORES - DESIGN OF INDUCTORS FOR POWER FILTER APPLICATIONS Fri Nov 18 08:19:05 2011

DTMSS-12,5/0,068/1,0

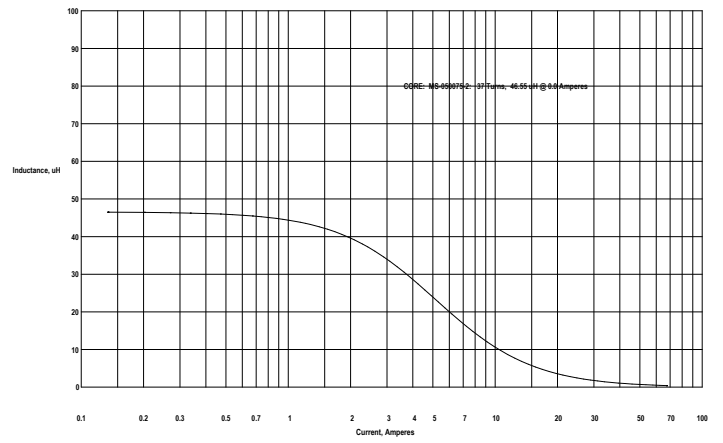

CREATED IN MICROMETALS ARNOLD POWDER CORES - DESIGN OF INDUCTORS FOR POWER FILTER APPLICATIONS Fri Nov 18 08:20:47 2011

DTMSS-12,5/0,047/1,2

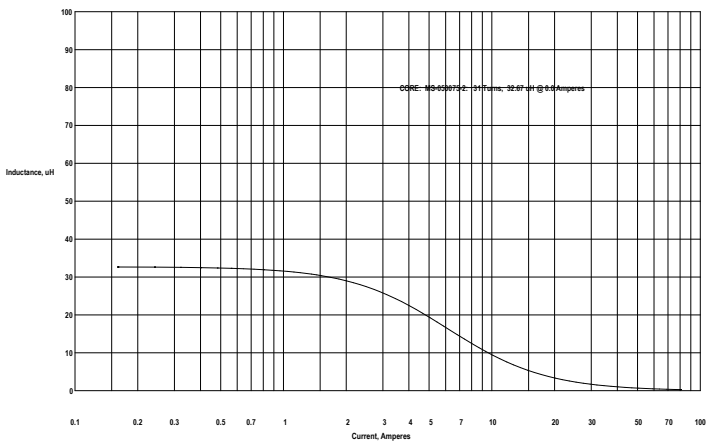

CREATED IN MICROMETALS ARNOLD POWDER CORES - DESIGN OF INDUCTORS FOR POWER FILTER APPLICATIONS Fri Nov 18 08:45:40 2011

DTMSS-12,5/0,033/1,9

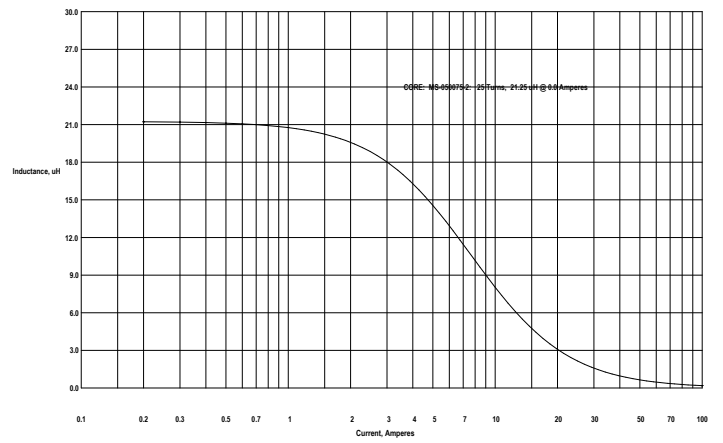

CREATED IN MICROMETALS ARNOLD POWDER CORES - DESIGN OF INDUCTORS FOR POWER FILTER APPLICATIONS Fri Nov 18 08:47:32 2011

DTMSS-12,5/0,022/2,4

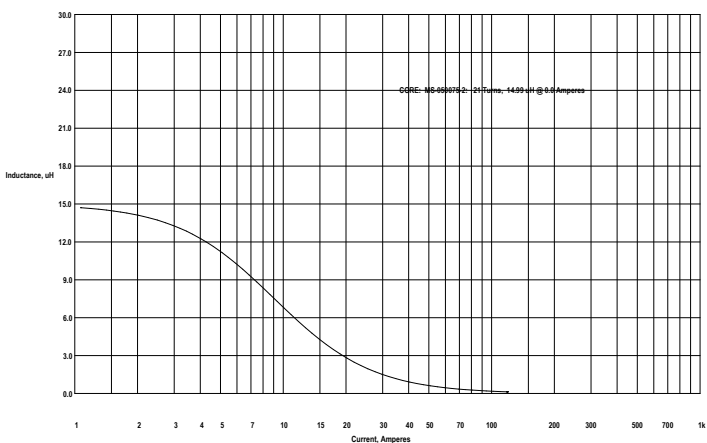

CREATED IN MICROMETALS ARNOLD POWDER CORES - DESIGN OF INDUCTORS FOR POWER FILTER APPLICATIONS Fri Nov 18 08:49:41 2011

DTMSS-12,5/0,015/4,0

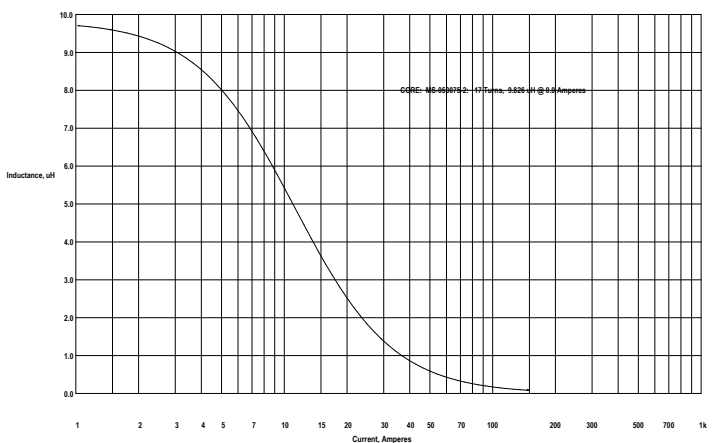

CREATED IN MICROMETALS ARNOLD POWDER CORES - DESIGN OF INDUCTORS FOR POWER FILTER APPLICATIONS Fri Nov 18 08:50:39 2011

DTMSS-12,5/0,010/6,0

CHARACTERISTICS:

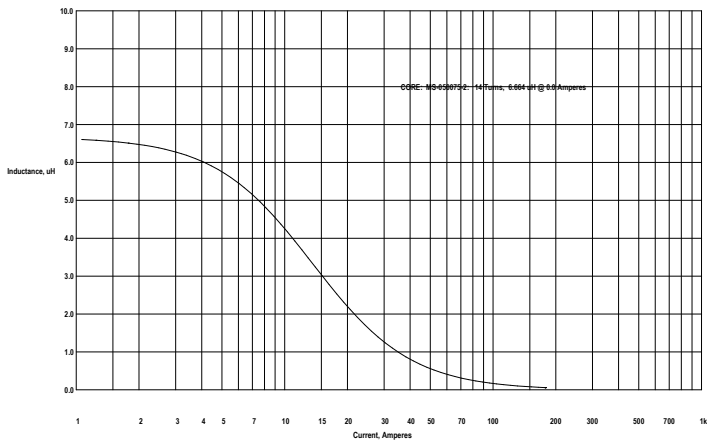

CREATED IN MICROMETALS ARNOLD POWDER CORES - DESIGN OF INDUCTORS FOR POWER FILTER APPLICATIONS Fri Nov 18 09:19:12 2011

DTMSS-12,5/0,0068/8,0

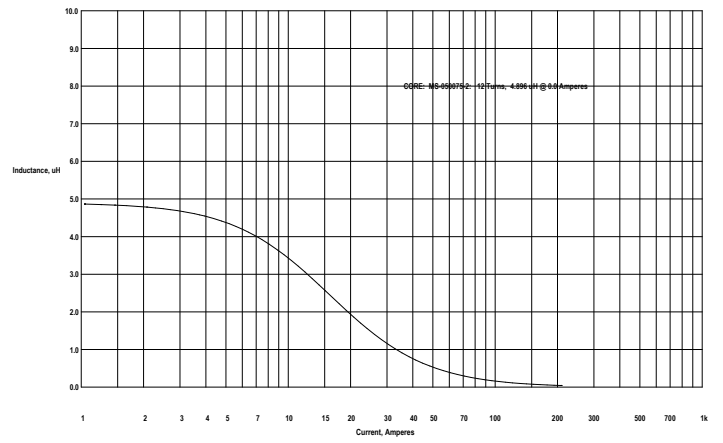

CREATED IN MICROMETALS ARNOLD POWDER CORES - DESIGN OF INDUCTORS FOR POWER FILTER APPLICATIONS Tue Nov 08 13:24:15 2011

DTMSS-12,5/0,0047/10

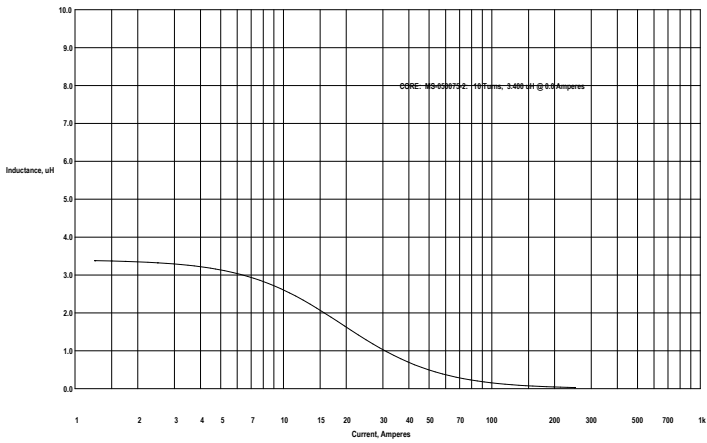

CREATED IN MICROMETALS ARNOLD POWDER CORES - DESIGN OF INDUCTORS FOR POWER FILTER APPLICATIONS Fri Nov 18 09:52:00 2011

DTMSS-12,5/0,0033/15