

SEZIONE A-A

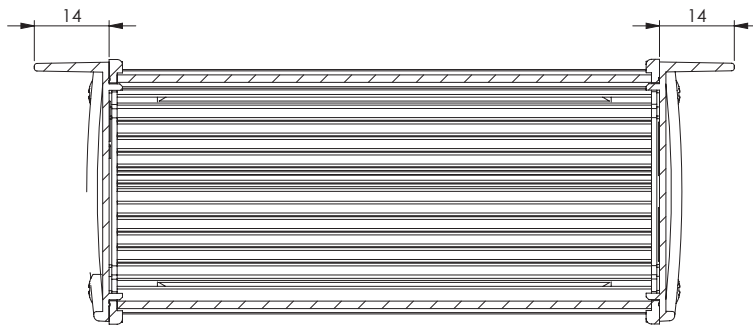

SEZIONE B-B

MAXIMUM PCB SIZE

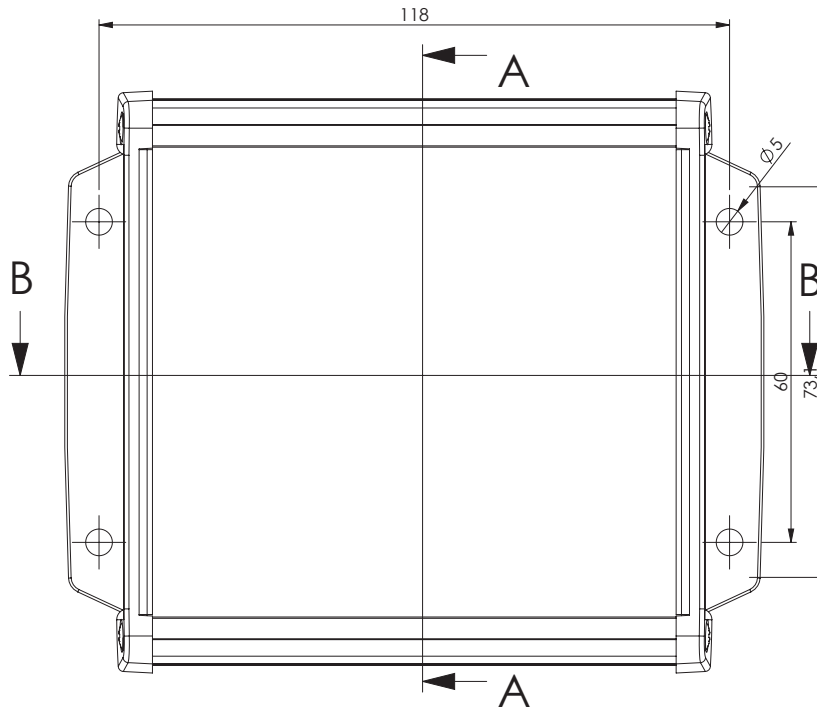
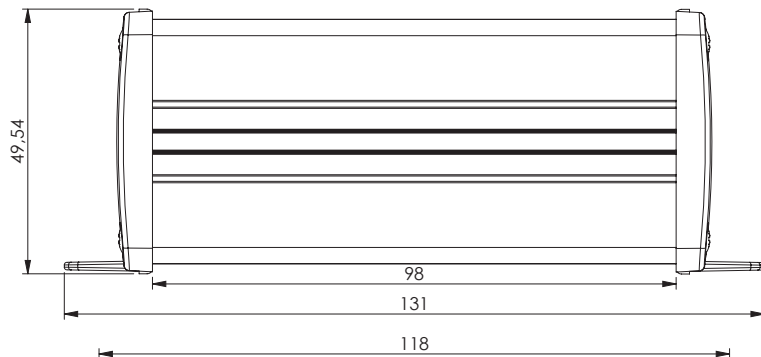
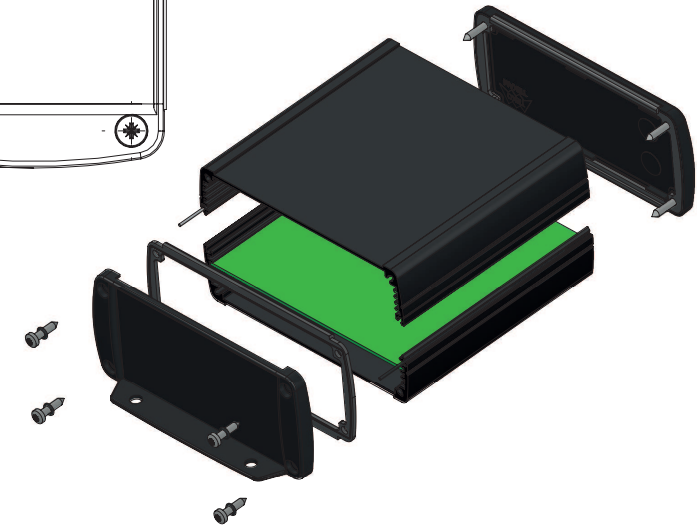
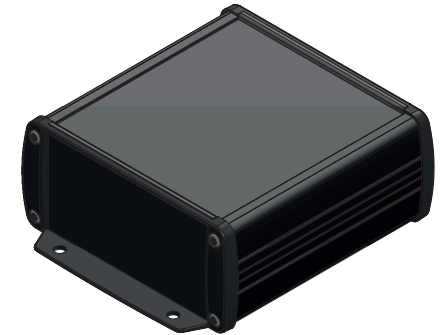
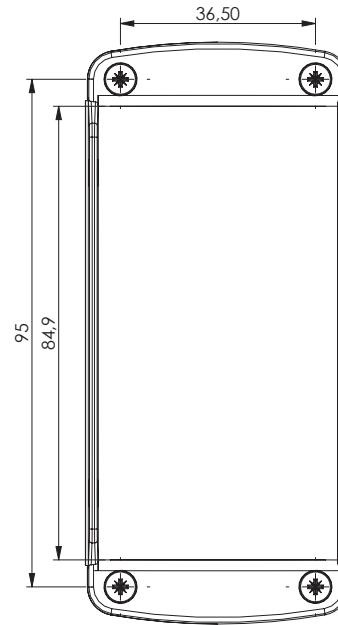
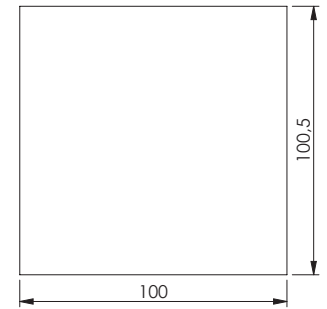

Proprietary and Confidential		TEKO S.p.A. Via dell'Industria 5 - S.Lazzaro di Savena - BO - IT		
TEKO [®]				
ENCLOSURES				
<i>Subject to technical modification without prior notice. Tipographical and others errors do not justify any claim for damages. All dimensions should be verified using an actual moulded part.</i>				
Part Number:	Date:	Sheet:	First angle prj.	
TEKAM 31L-E	15/03/2013	1 of 1	☐ ⊙	
Size: A3		Scale: 1:1		
This document contains proprietary information of TEKOS.p.a. and is rendered subject to the conditions that the information be retained in confidence not be reproduced or copied and not be used or incorporated in any product.				