

Step switch with OFF position Flush mounting



Powering Business Worldwide™

Part no.
Article no.

T0-3-8244/E
095803

Program

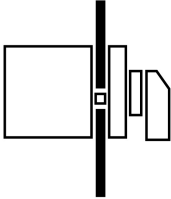
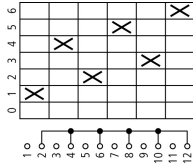
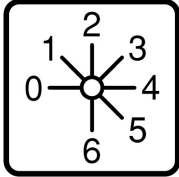
Range			Control switches
Basic function			Step switches
Part group reference (e.g. DIL)			T0
Design			Built-in
			
Protection type			Front IP65
Emergency stop			without emergency switching off/emergency stop function
			with black thumb grip and front plate One contact closed per step Without overlapping With 0 (Off) position
Contact sequence			
Front plate no.			 FS 426
Main conducting paths			
No. of poles		M	1
Max. motor rating			
AC-23A			
400/415 V 50-60 Hz	P	kW	6.5
Rated uninterrupted current	I _u	A	20

Approbationen

UL approval	Yes
CSA approval	Yes
Product Standards	UL 508; CSA-C22.2 No. 14-05; IEC/EN 60947-3; CE marking
UL File No.	E36332
UL CCN	NLRV
CSA File No.	12528
CSA Class No.	3211-05
NA Certification	UL listed, CSA certified
Specially designed for NA	Yes, in combination with "+NA" (105864)
Suitable for	Branch circuits
Degree of Protection	IEC: IP65; UL/CSA Type 3R, 12

General

Standards			IEC/EN 60947, VDE 0660, IEC/EN 60204, CSA, UL Switch-disconnectors to IEC/EN 60947-3 Load-break switches to IEC/EN 60947-3
Lifespan, mechanical	Operations	x 10 ⁶	0.5
Maximum operating frequency		Operations h	3000

Climatic proofing			Damp heat, constant, to IEC 60068-2-78; Damp heat, cyclical, to IEC 60068-2-30
Ambient temperature		°C	
Open		°C	- 25 - 50
Enclosed		°C	- 25 - 40
Mounting position			As required
Mechanical shock resistance to IEC 60068-2-27	Half-sinusoidal shock 20 ms	g	> 15

Contacts

Rated operational voltage	U_e	V AC	690
Rated impulse withstand voltage	U_{imp}	V AC	6000
Overtoltage category/pollution degree			III/3
Rated uninterrupted current	I_u	A	
open	I_u	A	20
Enclosed	I_u	A	20
Load rating with intermittent operation, class 12			
AB 25 % DF		$x I_e$	2
AB 40 % DF		$x I_e$	1.6
AB 60 % DF		$x I_e$	1.3
Short-circuit rating			
Fuse		A gG/gL	20
Rated short-time withstand current (1 s current)	I_{cw}	A_{rms}	320
Safe isolation to VDE 0106 Part 101 and Part 101/A1			
between the contacts		V AC	440
Switching angles		°	90 60 45 30
Contact units			11
Double-break contacts			max. 22
Current heat loss per contact at I_e		W	0.6

Terminal capacities

Solid or stranded		mm ²	1 x (1 - 2.5) 2 x (1 - 2.5)
Flexible with ferrule to DIN 46228		mm ²	1 x (0.75 - 1.5) 2 x (0.75 - 1.5)
Terminal screw			M3.5
Tightening torque		Nm	1

Switching capacity

AC		$x U_s$	
Rated making capacity $\cos \varphi = 0.35$		A	130
Rated breaking capacity, motor load switch $\cos \varphi = 0.35$		A	
230 V		A	100
400 V		A	110
500 V		A	80
690 V		A	60
Rated operational current 440 V load-break switch AC-21A	I_e	A	20
Rating, AC-3 motor load switch	P	kW	
220/230 V	P	kW	3
230 V Star-delta	P	kW	4
400 V	P	kW	4
400 V Star-delta	P	kW	5.5
500 V	P	kW	5.5
500 V Star-delta	P	kW	7.5

690 V	P	kW	4
690 V Star-delta	P	kW	5.5
AC-23A Motor load switches (main switches maintenance switches)	P	kW	
230 V	P	kW	3.5
400 V	P	kW	6.5
500 V	P	kW	7.5
Rated operational current control switch AC-15			
230 V	I _e	A	6
400 V	I _e	A	4
500 V	I _e	A	2
DC		x U _s	
DC-1, Load-break switches L/R = 1 ms			
Rated operational current	I _e	A	10
Voltage per contact pair in series		V	60
DC-21A	I _e	A	
Rated operational current 240 V	I _e	A	1
240 V Contacts		Quantity	1
DC-23A, motor load switch L/R = 15 ms			
24 V			
Rated operational current	I _e	A	10
Contacts		Quantity	1
48 V			
Rated operational current	I _e	A	10
Contacts		Quantity	2
60 V			
Rated operational current	I _e	A	10
Contacts		Quantity	3
120 V			
Rated operational current	I _e	A	5
Contacts		Quantity	3
240 V			
Rated operational current	I _e	A	5
Contacts		Quantity	5
DC-13, Control switches L/R = 50 ms			
Rated operational current	I _e	A	10
Voltage per contact pair in series		V	32
Control circuit reliability at 24 V DC, 10 mA	Fault probability	H _F	< 10 ⁻⁵ , < 1 fault in 100000 operations

Notes

Notes The following applies for solid, multiwire, and flexible terminal capacities:
If 2 conductors are being used, a max. difference of 2 cross-section categories is permissible

Technical data according to ETIM 4.0

Suitable for front mounting			YES
Complete device in housing			No
Suitable for rear mounting			No
Device construction			Flush-mounting device
Type of control element			Toggle
Max. rated operating voltage U _e at AC		V	690
Rated uninterrupted current I _u		A	20
Protection type (IP), at front			IP65
Front shield size			48x48 mm
Suitable for base fixing			No
Switch function			Step switch
Number of poles			1

Number of switch positions

7

Suitable for distribution board installation

No

Characteristics

Form for ordering non-standard front plates

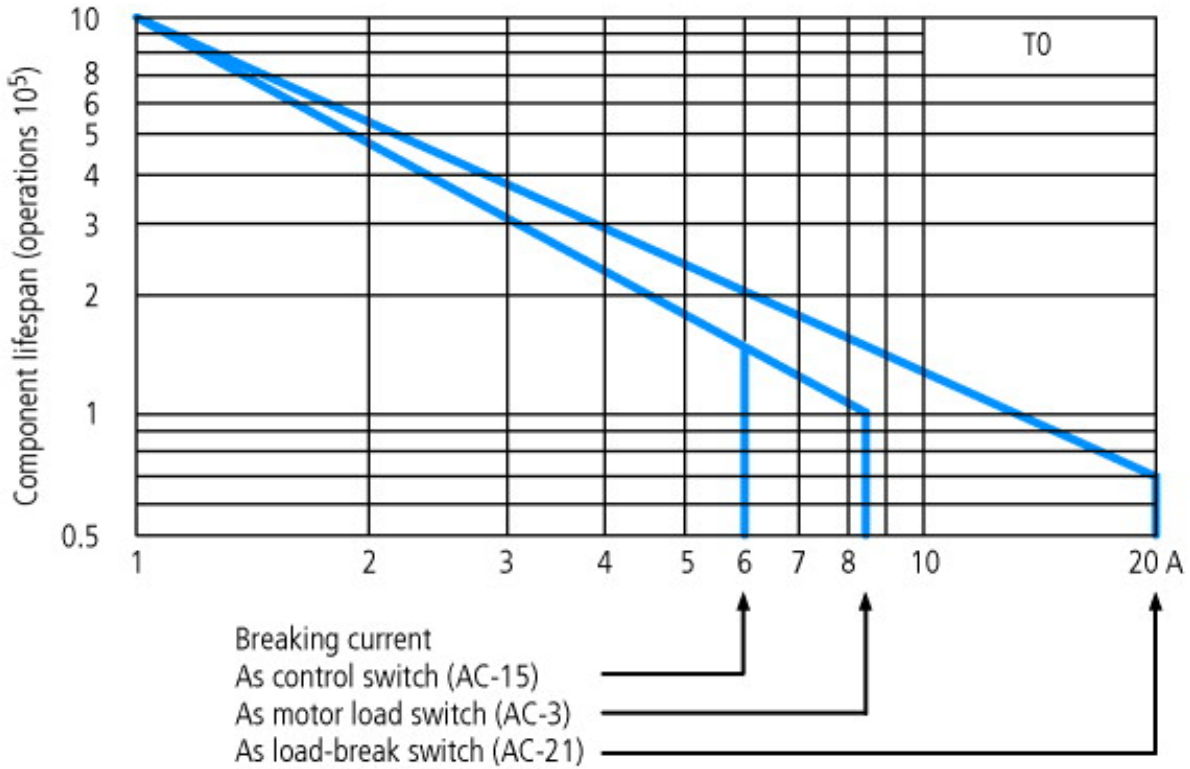

For utilisation category AC-4 (extreme load: 100 % inching, reversing or plugging)

The blocked rotor current of the motor should not exceed the rated current of the switch for AC-21A to ensure a reasonable device lifespan.

Dimensions

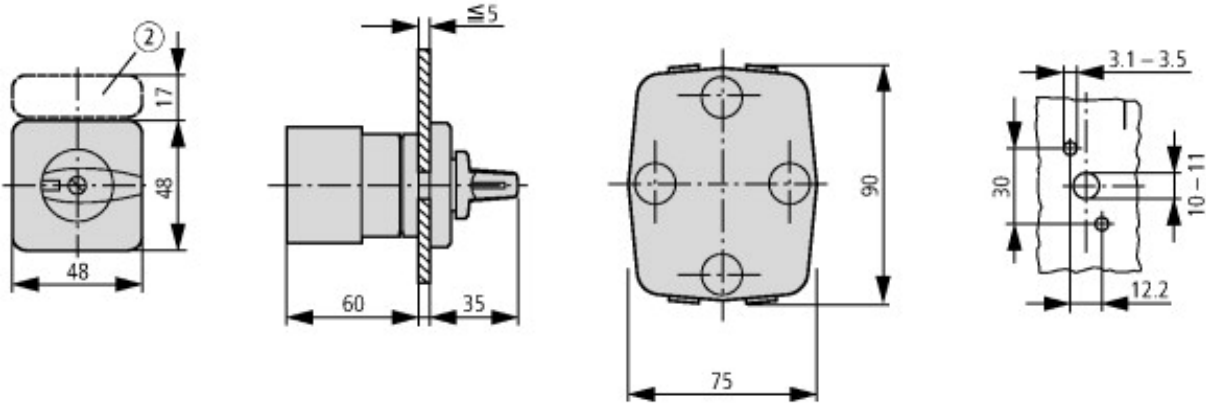

② Label mount not included as standard

One contact unit depth: 9.5 mm



Diameter of drilled hole Door



Key operation lock mechanism
T0.../E + S-(SOND-)T0

Additional product information (links)

Engineering

Technical overview	ftp://ftp.moeller.net/DOCUMENTATION/PDF/GB/Ovt_t_p_Leistung_G.pdf
Key to part numbers, modular system	ftp://ftp.moeller.net/DOCUMENTATION/PDF/GB/Ovt_t_p_Typenschlüssel_G.pdf
Ordering of non-standard switches	ftp://ftp.moeller.net/DOCUMENTATION/PDF/GB/Bestellformulare_de.pdf