

ROBERTS

Enjoy Listening

STREAM 205

DAB/FM WiFi Internet Radio with Music Player and Last.fm

Now supports remote control from iPhone or iPod touch and Windows 7 'Play to' function



Digital Audio Broadcasting

last.fm

Please read this manual before use

Contents

Introduction	2-9	DAB mode	61-69
Before you can use this product.....	3	Selecting a DAB radio station.....	62
About this instruction manual.....	4	Display modes.....	63-64
Controls and connections.....	5-6	Finding new DAB radio stations.....	65
Battery operation.....	7	Manual Tuning.....	66
Navigation controls.....	8-9	Dynamic Range Control settings.....	67
Configuration	10-21	Station order setup.....	68
Plugging in and language selection.....	10-11	Prune stations.....	69
Clock and time settings.....	12	FM mode	70-75
Connecting to your computer network.....	13-17	Manual tuning.....	71
Manual network configuration.....	18-20	Display modes.....	72
Network remote control options.....	21	Scan setting.....	73
Internet Radio mode	22-35	Stereo / Mono switching.....	74
Internet Radio - the basics.....	22	Presetting stations in DAB and FM modes.....	75
Selecting a radio station by location and genre.....	23-25	Clock and Alarms	76-84
Searching for a radio station by name.....	26	Automatically updating the clock.....	76
Selecting a new or popular station.....	27	Setting the clock format.....	77
Selecting a podcast / BBC Listen Again.....	28	Manually setting the clock.....	78-79
Presetting stations.....	29	Setting the alarm clock.....	80-82
Display modes.....	30-31	Disabling alarms.....	83
Customising your radio.....	32-35	Snooze timer.....	83
Music Player mode	36-51	Sleep timer.....	84
Use with Windows, Apple Mac, Linux, USB memory.....	36	Display and Audio	85-88
Accessing your audio files via UPnP using Windows 7.....	37-38	Brightness control.....	85
Locating and playing media files using UPnP.....	39-43	Contrast / viewing angle control.....	86
Using USB memory devices.....	44-45	Headphone socket.....	87
Playlists.....	46-48	Auxiliary input socket.....	88
Prune servers.....	49	Information	89-102
Wake On LAN.....	49	Factory reset.....	89
Windows 7 'Play To' function.....	50-51	Software update.....	90
Last.fm mode	52-60	Network profiles.....	91
Last.fm - the basics.....	52	Software version display.....	92
Set up a Last.fm user account.....	53	Troubleshooting.....	93-94
Listening to Last.fm.....	55-57	Accessing audio files via UPnP using Windows Vista and XP.....	95-96
Display modes.....	58	Audio codecs.....	97
Your Recent Stations / History.....	59	Cautions and Specifications.....	98-99
Deleting details of a Last.fm account.....	60	Guarantee.....	102
Scrobbling - On / Off control.....	60		

Stream 205 Internet Radio features

The Roberts Stream 205 provides the following features in an attractive compact unit:-

- Listen to local, regional, national and international broadcasts using FM, DAB and Internet radio
- Listen to over 1000 radio stations from around the country, and over 10,000 from around the world without using your PC.
- Listen to previously broadcast material from the BBC (using Podcasts / Listen Again)
- Listen to podcasts from a wide range of broadcasters.
- 15 radio station presets (5 Internet Radio, 5 DAB and 5 FM).
- Use the Music Player to play your music collection from your computer (using Windows Media Player 11 or 12). Connection to Apple and Linux based computers is also possible.
- Playback of audio files from USB memory devices.
- MP3, WMA, AAC, FLAC, WAV and Real Audio formats are supported (Real Audio for Internet Radio only).
- The Stream 205 connects to your home computer network, either using WiFi or via a wired Ethernet connection.
- WiFi Protected Setup (WPS) is supported for simpler setting up with compatible wireless routers.
- Works with Windows 7 'Play to' function (as UPnP renderer).
- Supports remote control from Apple iPhone or iPod touch using Roberts ConnectR app.
- Works with Last.fm, an on-line music service with millions of tracks available. It plays personalised radio stations based on your choice of artists, songs, listening history and similar tracks based on the preferences of other Last.fm listeners with similar music tastes.
- Multi-language menu system (menus may be displayed in English, French, German, Italian, Danish, Dutch, Finnish, Norwegian, Polish, Portuguese, Spanish, Swedish, Turkish).
- All radio station presets, network configuration details and user settings are retained in the event of a power failure.
- Large clock display with time and date when in Stand-by.
- Two alarm timers with snooze feature to wake you to either buzzer or radio alarm.
- Adjustable sleep timer, can be set to turn the radio off between 15 and 120 minutes.
- Easy-to-read graphic display.
- Adjustable display backlight.
- Auxiliary input socket for playing audio from MP3 players, iPods or other audio equipment.
- Stereo headphone socket for private listening.
- Mains or battery powered operation using supplied mains adapter, or 6 x LR20 (D size) alkaline cells (not included).

Before you can use this product

Before you can use your radio, you must have the following:

- A broadband Internet connection (not required for DAB, FM or Music Player functions).
- A wireless access point (WiFi) or a wired Ethernet connection connected to your broadband Internet Service Provider, preferably via a router. In many cases the broadband modem, router and wireless access point will be a single combined unit supplied by your Internet Service Provider or bought from a computer store.
- If your wireless network is configured to use Wired Equivalent Privacy (WEP) or WiFi Protected Access (WPA/WPA2) data encryption then you either need to know the WEP, WPA or WPA2 key used for encryption so you can get the radio to communicate with the network, or your router needs to offer WiFi Protected Setup (WPS).

If connecting using WiFi, the radio will typically work within a 10-20 metre radius from your wireless access point. The actual range achieved will depend upon the building type, other nearby wireless networks, and possible interference sources. DAB and FM radio functions can operate wherever the radio is able to receive a suitable broadcast signal.

IMPORTANT: Before you continue, make sure that your wireless access point or router is powered up and working with your broadband Internet service (use your computer to verify this). To get this part of the system working you must read the instructions supplied with the wireless access point or router.

About this instruction manual

This instruction manual is split into sections for each of the different operating modes of your Roberts Stream 205 radio. Each section is clearly identified by the shaded heading in the top right hand corner of each pair of pages.

Before using the Internet Radio and Music Player functions, you will need to connect your radio to your computer network using either the WiFi or Ethernet connection. This is covered in the section titled **Configuration**.

The **Internet Radio** section describes how to find radio stations to listen to. These can be radio stations that you already know and listen to conventionally, or new stations you may search for. You may set up stations that you like as Favourites so that they are more readily accessible.

The section for the **Music Player** describes how you may play music files that you may have stored on a computer connected to your network. The use of Shared Media (using UPnP) and USB playback is explained.

The **Last.fm** section explains the use of the radio in conjunction with the Last.fm internet based music streaming service.

The two sections for **DAB Radio and FM Radio** describe how to use the radio to listen to conventional radio broadcasts.

The section titled **Clock and Alarms** describes the different ways by which the clock in the radio may be set, as well as explaining the use of the alarms, snooze and sleep timer features.

The **Display and Audio** section shows how to adjust the display and connect your radio to other audio equipment.

The **Information** section includes troubleshooting, specifications and warranty information.

If you need any further advice, please call our Technical Helpline on 020 8758 0338 (Mon-Fri)

Introduction

Configuration (page 10)

Internet Radio (page 22)

Music Player (page 36)

Last.fm (page 52)

DAB Radio (page 61)

FM Radio (page 70)

Clock and Alarms (page 76)

Display and Audio (page 85)

Information (page 89)

Controls and connections

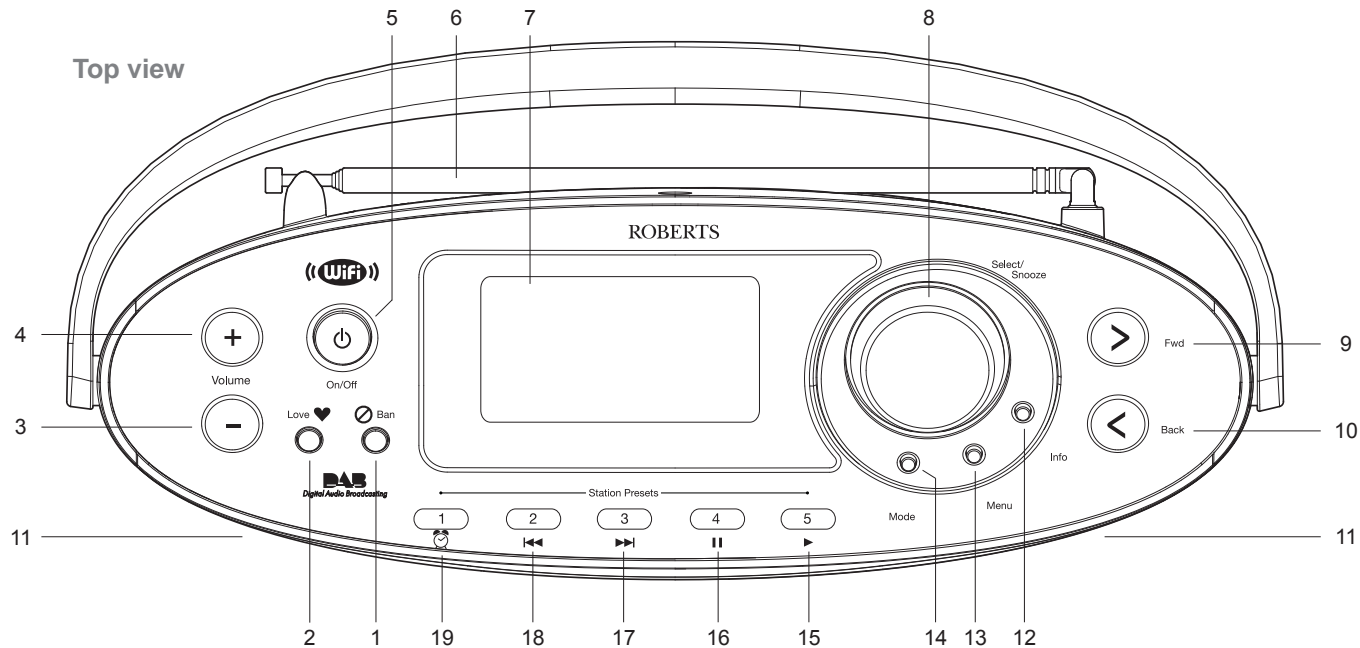

1. Last.fm Ban button
2. Last.fm Love button
3. Volume Down button
4. Volume Up button
5. On / Off button
6. Telescopic aerial

7. LCD display
8. Tuning / Select / Snooze control
9. Menu Forward button
10. Menu Back button
11. Loudspeaker x 2
12. Info button

13. Menu button
14. Mode button
15. Preset 5 / Play button
16. Preset 4 / Pause button
17. Preset 3 / Fast-forward button
18. Preset 2 / Rewind button
19. Preset 1 / Alarm On/Off button

Rear view

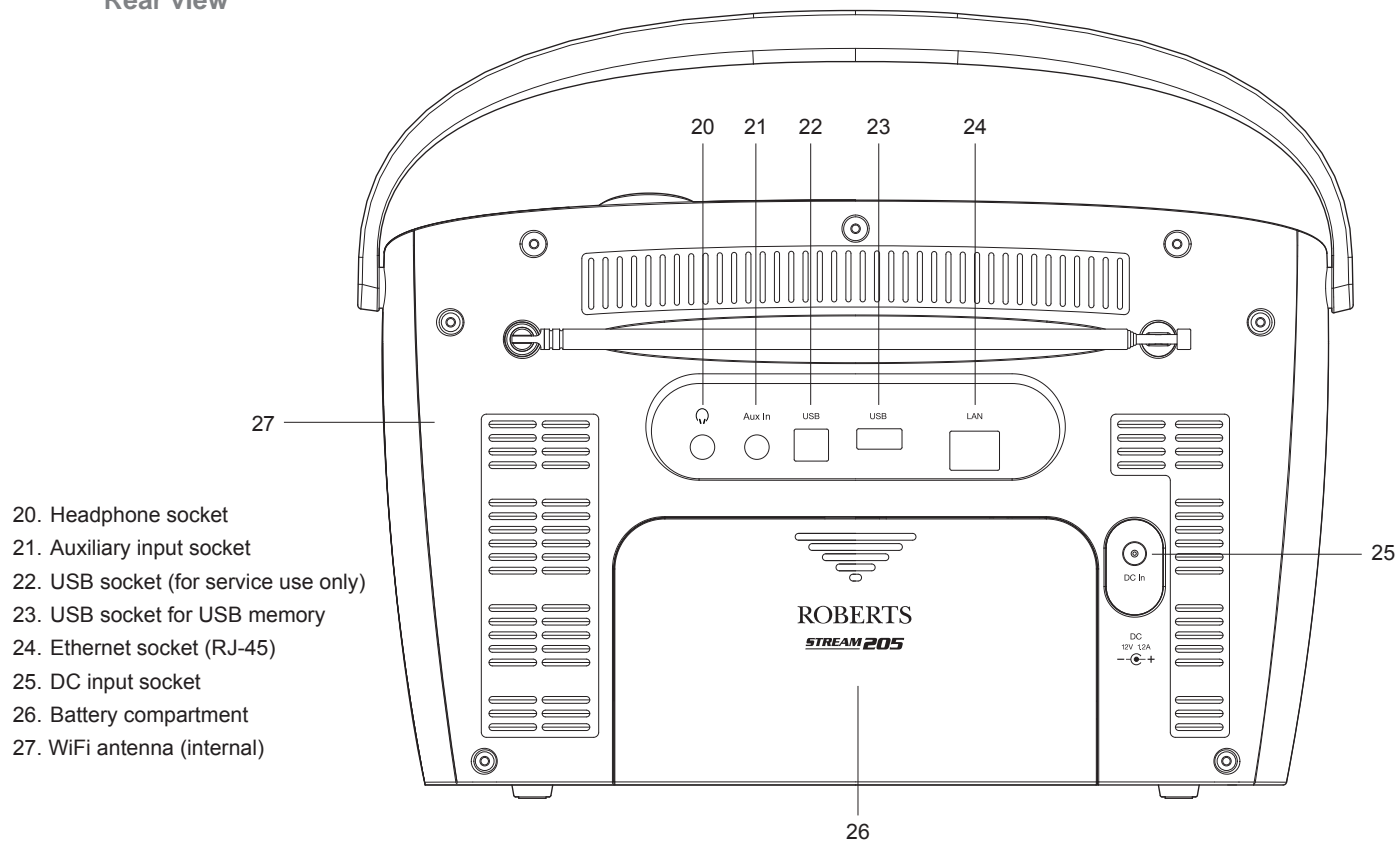

- 20. Headphone socket
- 21. Auxiliary input socket
- 22. USB socket (for service use only)
- 23. USB socket for USB memory
- 24. Ethernet socket (RJ-45)
- 25. DC input socket
- 26. Battery compartment
- 27. WiFi antenna (internal)

Battery operation

We recommend for economy that your radio is used via the AC adaptor whenever possible with battery operation for occasional use only. Inserting the adaptor plug into the DC input socket will disconnect the batteries.

If using batteries, only alkaline types should normally be used. Battery life will vary according to the use of the radio, but between 40 and 80 hours should be possible. WiFi use takes much more power than DAB listening, for example.

To install batteries in your radio follow these steps.

1. Remove the Battery cover on the rear of the unit by pushing the top of battery door in slightly and then sliding it downwards.
2. Insert six LR20 (D size) batteries into the spaces in the compartment. Take care to ensure all batteries are inserted with the correct polarity as shown inside the battery compartment. Replace the battery cover.
3. Reduced power, a stuttering sound, distortion or the radio switching itself off are all signs that the batteries may need replacing.
4. If the radio is not to be used for any extended period of time it is recommended that the batteries are removed from the radio.

Rechargeable Nickel Metal Hydride (NiMH) cells can be used in the radio but must be charged outside the radio using an external charger. Note that commercially available D size NiMH cells have a capacity which is only a small fraction of that of D size Alkaline cells and so they will power the radio for only a few hours before needing recharging. *Never mix batteries of different types, capacities or brands in the radio.*

IMPORTANT: The batteries should not be exposed to excessive heat such as sunshine, fire or the like. After use, disposable batteries should if possible be taken to a suitable recycling centre. On no account should batteries be disposed of by incineration.

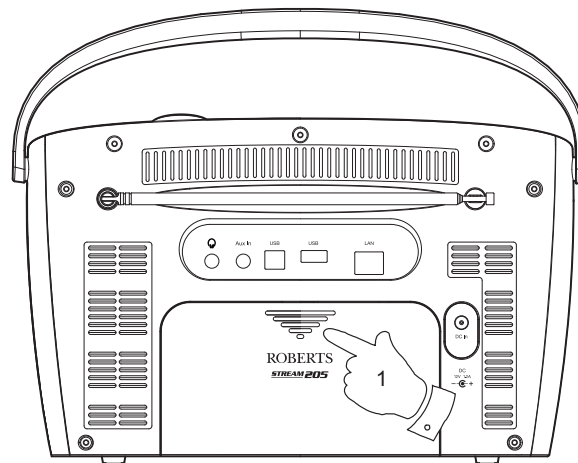

Navigation controls

These pages describe the basic means of controlling your Stream 205 radio. Instructions for each operating mode are given in the later sections of this book.

1. Pressing the **On/Off** button brings your radio out of Stand-by mode if running from mains or switches it on if using batteries.

Pressing the **On/Off** button while the radio is in use will cause it to return to the Stand-by mode with the clock display when running from the mains, or will switch it off after a short delay when running on batteries (alarms cannot be used when running on batteries).

2. Pressing the **Mode** button gives you access to each of the operating modes in turn: Internet Radio, Music Player, Last.fm, DAB radio, FM radio and Auxiliary Input.

3. Pressing the **Menu** button will access the menu system.

4. Many operations require the user to make a selection from the menu. This is done using the **Tuning/Select** control. Turn the control clockwise or anti-clockwise to highlight the desired menu item then press the control to select that item.

If there are more than five items in a menu, then the display will automatically scroll up or down so that the additional items become visible. A sliding bar on the right will give an indication showing the current portion of the menu that is displayed.

If there are many items in a menu, then the radio allows the menu to 'wrap around' in either direction. This can make it easier to reach items at the end of a long menu, such as a list of countries or Internet radio stations.

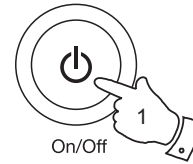

Mode

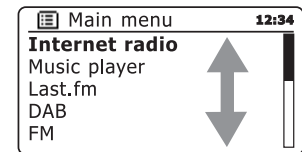
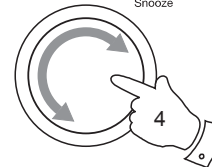

Menu

Select/
Snooze

Navigation controls cont.

- The **Forward** button may be used to make selections from the menus. If an error is made when navigating the menus, it is generally possible to go back to a higher level menu by pressing the **Back** button.
- The **Info** button allows the display of information relating to the radio station or music file being played.

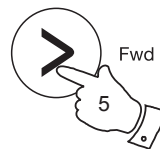

Note: In this booklet, press always means **press and release**.

Text entry

There are several occasions when you may need to enter text characters into your radio, for example, when setting up the WiFi connection, or when searching for artists or albums. When entering text you can use the **Tuning/Select** control alone or in conjunction with the buttons.

- Rotate the **Tuning/Select** control to highlight each character as needed and press the control to enter each character into the radio.

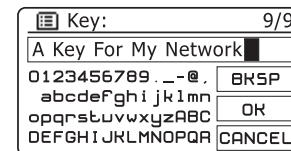
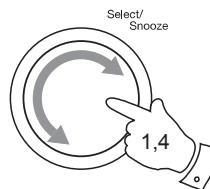

Alternatively

- To highlight the next character in the character display press the **Forward** button. Press and hold to move more quickly.
- To highlight the previous character in the character display press the **Back** button. Press and hold to move more quickly.
- To enter the highlighted character press the **Tuning/Select** control.
- The **Info** button allows quick access to the Backspace control. You can then use the **Tuning/Select** control to access the OK and Cancel options. Press **Info** again to go back to the character selection.

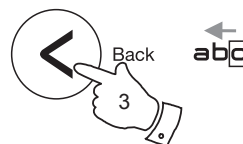
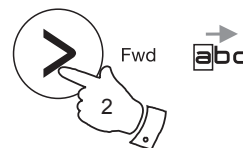

Plugging in and language selection

1. Place your radio on a flat surface and plug the cable from the mains adaptor into the **DC input socket** located at the rear of your radio (marked 'DC in') ensuring that the plug is pushed fully into the socket.
2. If you wish to use a wired network connection, plug the Ethernet cable into the RJ-45 socket at the back of the radio.
3. Plug the mains adaptor into a wall socket and switch on the socket.

IMPORTANT: The mains adaptor is used as the means of connecting the radio to the mains supply. The mains socket used for the radio must remain accessible during normal use. In order to disconnect the radio from the mains, the mains adaptor should be removed from the mains socket outlet completely.

4. When you apply power, the display on the radio will light up and say: 'ROBERTS' and 'STARTING' with a progress indicator. The first time that you use your radio (or after a Factory Reset) the display will show 'Setup wizard' and 'YES' will be highlighted on the screen.
5. By default your radio will display all menus and messages in English. If English is your preferred language then press the **Tuning/Select** control to select 'YES' and to begin setting up your radio. Then please skip to step 1 on page 12.
6. If your preferred language is not English, then rotate the **Tuning/Select** control so that the 'NO' option is highlighted. Press the **Tuning/Select** control to enter the selection. Continue on the next page.

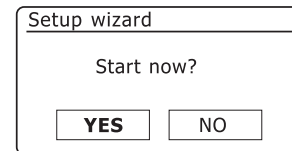
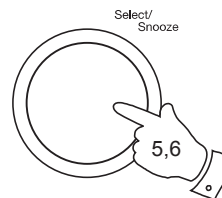
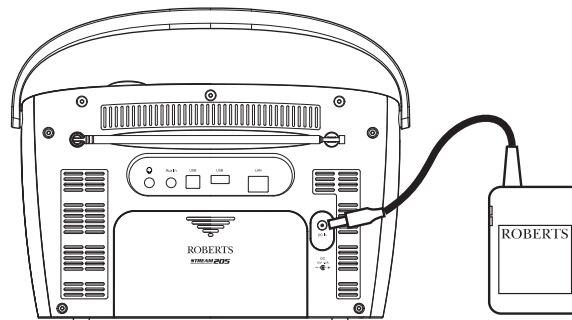

Plugging in and language selection - cont.

- Your radio will ask whether the Setup Wizard should be run at the next start up. The 'NO' option will be highlighted.
Press the **Tuning/Select** control to select the 'NO' option.
- Your radio will then display the Main Menu. Rotate the **Tuning/Select** control until 'System settings' is highlighted on the screen.
Press the Tuning/Select control to enter the System settings menu.
- Rotate the **Tuning/Select** control until 'Language' is highlighted on the screen.
Press the Tuning/Select control to enter the Language options menu.
- Rotate the **Tuning/Select** control until the desired language is highlighted on the screen.
Press the Tuning/Select control to select the chosen language option.
The display will then change to show the System settings menu in the chosen language.
- Rotate the **Tuning/Select** control until the 'Setup wizard' option is highlighted on the screen and then press the control.
If you change the language you will not see 'Setup wizard' in English. You will see an equivalent menu item in your language - for example, 'Assistant réglages' in French, or 'Inställningsguide' in Swedish.
- Rotate the **Tuning/Select** control until 'YES' is highlighted on the screen and press the control to select it.
This will cause the radio to run the set up procedure as if it had just been switched on for the first time, but it will do this using the language selected in step 10, above.
- Continue setting up your radio on the next page.

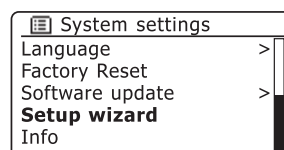
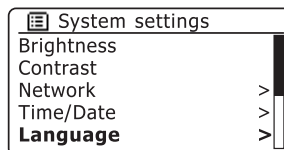
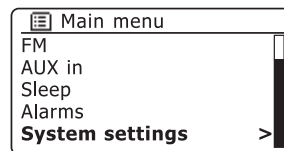
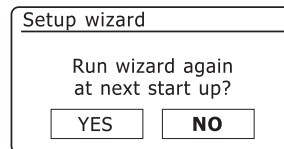
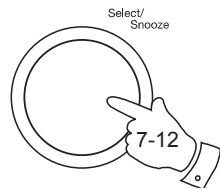

Clock and time settings

The following instructions assume that you have either just plugged in your radio (see page 10) or that you have just specified the language option for the menus (see page 11).

1. Rotate the **Tuning/Select** control to highlight the desired clock format (either 12 or 24 hour) then press the control to enter your selection.
2. Next, the way in which the radio updates its clock is set. A menu allowing you to specify the auto-update option for the clock will be shown. The 'Update from Network' option will be best for most users.
3. Rotate the **Tuning/Select** control to choose an auto-update option for the clock. This can be updated from DAB or FM radio, from the Network, or not updated. The default is to auto-update from the network. Press the control to enter your selection. If you choose another option go to 'Connecting to your computer network' on page 13. Otherwise you will first need to select the correct time zone and daylight savings setting, see the next steps. If you choose 'No update' you will need to set the clock manually later, see page 78. Press the control to confirm your choice.
4. Rotate the **Tuning/Select** control to highlight the time zone for your current location. Press the **Tuning/Select** control to enter the setting.
5. You will then need to set the Daylight Savings option according to your location (Daylight Savings is also known as Summer/Winter time or BST/GMT adjustment).
 Rotate the **Tuning/Select** control to highlight 'ON' or 'OFF' as required. The asterisk shows the current setting.
 In the UK, 'ON' is equivalent to British Summer Time and 'OFF' is equivalent to Greenwich Mean Time.
6. Continue setting up your radio on the next page.

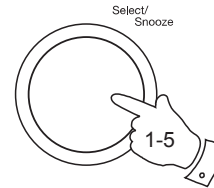

Date/Time

12/24 hour format

Auto update

Update from DAB
 Update from FM
Update from Network *
 No update

Set timezone

UTC+00:00:Dublin, Lon
 UTC+00:30:
 UTC+01:00:Madrid, Arr...
 UTC+01:30:
 UTC+02:00:Athens, Ca...

Daylight savings

Daylight savings

Connecting to your computer network

Before you can use your Stream 205 radio to listen to internet radio or to music streamed from your computer, it must first be connected to your computer network.

This section of this book describes how to connect the radio to your network using either the wireless (WiFi) connection or the wired (Ethernet) connection.

The following instructions assume that you have just set up the clock and time options using the Setup Wizard as described on the preceding page.

These instructions also apply to the Network Wizard in the Network Settings menu (from step 2 onwards).

1. After setting the Daylight Savings options (see page 12), the display will show a list of WiFi regional options for the network set up.

Rotate the **Tuning/Select** control to highlight the required region (for the UK choose *'Most of Europe'*), and then press the control to make the selection. Do this even if you are planning to use the wired Ethernet connection.

Your radio will then scan for available WiFi networks.

2. The radio will enter the Network Settings Wizard and will display 'Scanning...'. After a short while the display will show a list of the available WiFi networks. If you are intending to use the WiFi connection, go to step 3 on the next page.

To use the Ethernet connection to your router (with automatic configuration), rotate the **Tuning/Select** control to point to the *'[Wired]'* menu item. Press the control and the radio will attempt to connect.

If your network allows automatic configuration (which is normal) the radio will acquire a network address. The screen should say *'Connecting...'*, and then *'Setup wizard completed'*. Press the **Tuning/Select** control to exit the setup wizard and show the main menu. You can then skip to paragraph 10 on page 16.

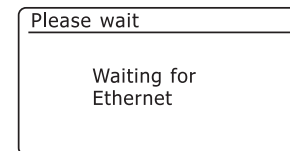
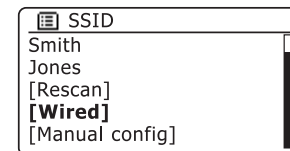
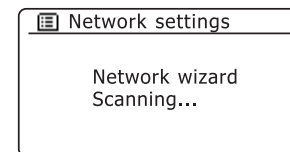
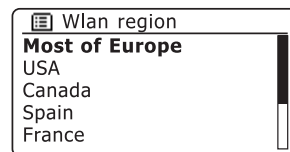
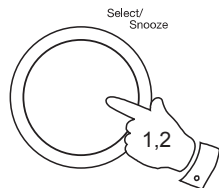

Connecting to your computer network - cont.

There are two indicator lights incorporated into the RJ-45 connector. If you have problems with your wired connection, they may help you to identify the possible cause of the problem.

Green ON = Link established; OFF = no connection

Green Flashing = Data transfer

Yellow ON = 100 Mbits/sec link; OFF = 10 Mbits/sec link

If your network does not support automatic configuration or if you wish to set it up manually then you should select '*Manual config*' instead of selecting '*Wired*' in the Network Wizard, then go to page 18.

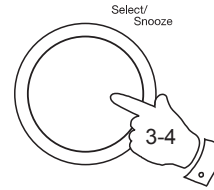

- If you plan to use a WiFi connection, you will first need to identify your network in the list of network names presented by the Network Wizard. If no networks are found then you may have to get your wireless router working (please see the instructions supplied with it) or you may be too far from the router.

When the radio finds your wireless network, it displays the Network Name (SSID) for the wireless access point on the screen. This is a name that is allocated to the access point in your router by the person who set up the network - for example: '*Jones family*' or '*Paul's network*'. If the router supports WiFi Protected Setup, then '*WPS*' will be shown in front of the SSID.

It is possible, and in some locations highly likely, that your radio will find more than one wireless network, in which case you should choose which one you need to connect to.

- Rotate the **Tuning/Select** control to see the SSID for each wireless network that has been found. If your network is shown proceed to step 6 on the next page. If it is *not* shown then proceed to step 5, also on the next page.

If you make a mistake at any point, use the **Back** button to go back to the previous screen.

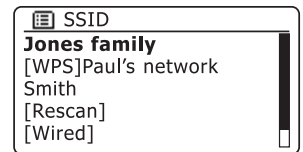
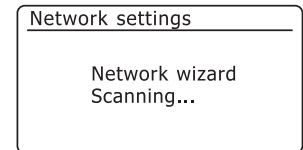
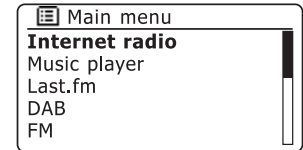
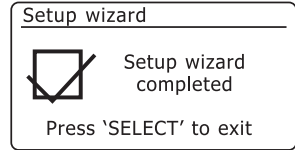
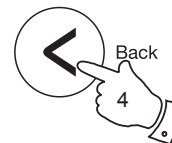

Connecting to your computer network - cont.

- If your network is not found, it may be because the router is configured not to broadcast the SSID. You should then use the **Tuning/Select** control to highlight and select the '*Manual config*' option in order to enter the network details manually. This is described in 'Manual Network Configuration', see page 18.

If your network name is being broadcast, and it was not found, then try re-scanning (press the **Back** button), and if necessary try moving your radio to a location closer to your access point / router.

- When the SSID for the wireless network you wish to connect to is highlighted on the screen, press the **Select** control. If WiFi Protected Setup (WPS) was indicated, you will see an additional menu at this point, otherwise proceed to step 7.

Choose one of the WPS menu options as required for your router (WPS may be via push button, or using an identification number).

'*Push Button*' - the display prompts you to press the WPS button on your router and then the **Select** control on the radio. The two devices should then connect with the encryption key sent automatically to the radio.

'*PIN*' - the display shows an identification number which you must enter into your router using a web browser (refer to your router's user documentation). You should then press the **Select** control on the radio. The two devices should then connect with the encryption key sent automatically to the radio.

'*Skip WPS*' - if you wish to enter the encryption key yourself (or if it was previously entered).

If you chose Push Button or PIN the screen will then show '*Connecting...*' and then '*Setup wizard completed*'. Press the **Tuning/Select** control to exit the setup wizard and then go to paragraph 10 on the next page.

- If your network is configured without an encryption key, the screen should say '*Connecting...*', and then '*Setup wizard completed*'. Press the **Tuning/Select** control to exit the setup wizard and show the main menu. If this is the case then you have successfully connected your radio to your network, so please go to paragraph 10 on the next page.

- If the screen displays '*Key:*', it is because the network is using one of the encryption systems: Wired Equivalent Privacy (WEP) or WiFi Protected Access (WPA). You will need to enter the correct WEP or WPA key into the radio to allow it to communicate with your wireless network. If you do not have the WEP or WPA key, then you should obtain it from the person who set up your network. Some wireless routers may come with an encryption key already set up by the supplier, in which case you should refer to the documentation provided with it. WPA is used here to also include WPA2.

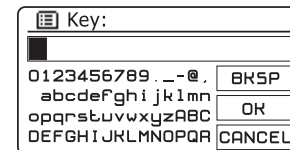
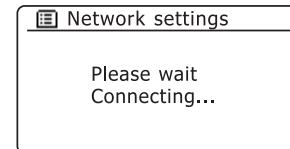
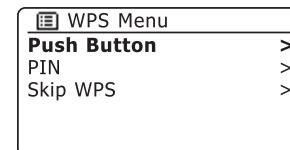
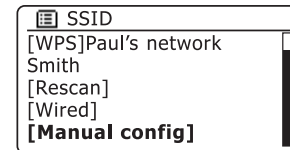
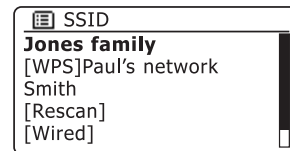

Connecting to your computer network - cont.

WEP keys are 10 or 26 characters long (using 0 - 9, and A - F). Some wireless routers can also use pass-phrases for WEP but these are not supported by the radio. WPA keys are usually set up using a pass-phrase of between 8 and 63 characters. Your radio accepts pass-phrases for WPA keys.

- To enter the WEP or WPA key, characters are selected and entered using the **Tuning/Select** control. As you rotate the control, the highlight scrolls through the available characters as well as the three controls on the right. The character currently highlighted will be entered when you press the **Tuning/Select** control.

Do this as needed until the complete key has been entered. *Remember, WEP keys only use the numbers 0-9 and letters A-F. WPA keys are sensitive to upper and lower case characters. You must enter the key **exactly** or the radio will not connect to the network.*

The three controls on the right-hand side of the screen have special functions. You can quickly access these by pressing the **Info** button and then using the **Tuning/Select** control as needed:

select '**BRSP**' to erase a character just entered (long press to clear); **Info** again to continue

select '**OK**' when the complete key has been entered

select '**CANCEL**' to cancel and re-run the Network Wizard

If a WEP or WPA key has previously been entered for the selected SSID then the display will show 'Key: [Set]'. If you have previously entered a different key, you must clear this by selecting the '**BRSP**' symbol. This will remove the '[Set]' indication.

After the final character of the WEP or WPA key has been entered, highlight the '**OK**' symbol and press the **Tuning/Select** control. The screen will show 'Connecting...' and then 'Setup wizard completed'. Press the **Tuning/Select** control to the exit setup wizard. The radio should now be able to connect to the network.

- Once you have connected your radio to the network (and therefore also to the Internet) it will display the main menu. Press the **On/Off** button to put the radio into standby mode. It should then display the time as obtained from the Internet. If the time display is not correct for any reason, it can easily be adjusted later, see page 78, 'Manually setting the clock'.

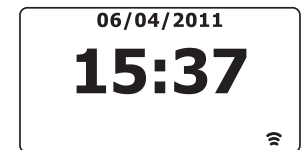
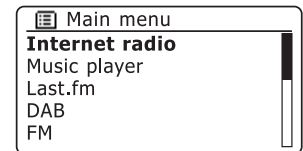
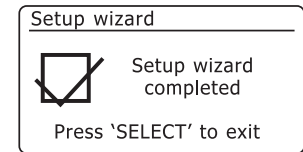
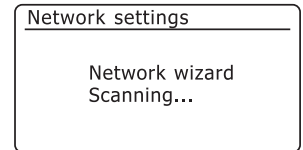
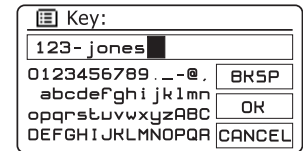
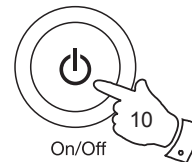
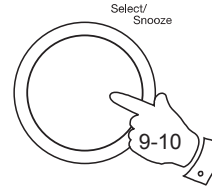

Connecting to your computer network - cont.

If you have followed the steps on the preceding pages successfully, your radio will have connected to your router, and then made a connection to the Internet and set its clock. If this is the case, then you can try listening to radio stations via the Internet as described on page 22 onwards.

Changing the network connection

In the sections above, you chose how your radio would be connected to your network, either using a WiFi connection or using a wired Ethernet cable. From time to time, you may find that you need to connect to different computer networks. The Internet setup menu allows you to change your radio's network settings, scan for an alternative wireless network, or to manually configure the network parameters.

The steps outlined below describe how you can do this - see also the section 'Network profiles' on page 91. If you have no need to do this, however, please skip to page 22.

Configuring the radio to use an alternative WiFi connection

1. From the Network settings menu select '*Network wizard*'. This will present you with details of any WiFi networks that are found. Scroll down the list using the **Tuning/Select** control to the desired network name. Press the control to select this network.

The radio will then use its WiFi system to communicate with the network. Depending on the settings for the new network you may need to enter an encryption key (see pages 15-16). By default the radio will then acquire an IP address and other network settings from your router using DHCP.

Configuring the radio to use the wired Ethernet connection

2. Connect your radio to your router using an Ethernet cable plugged into the RJ-45 socket at the back of the unit. From the Network settings menu select '*Network wizard*'. This will present you with details of any WiFi networks that are found. Scroll down the list to the '*[Wired]*' option using the **Tuning/Select** control. Press the control to select this.

The radio will then use its Ethernet connection to communicate with the network. By default the unit will then acquire an IP address and other network settings from your router using DHCP.

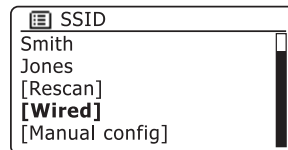
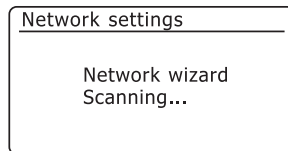
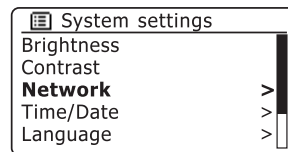
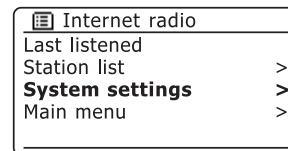

Manual network configuration

If you do not wish to use DHCP for automatic configuration, or if your network is configured with a hidden SSID, then you will need to enter some network settings manually. (Note - a hidden SSID may prevent casual observers from detecting your network, but it is not recommended as a means of network security.)

1. From the radios Network settings menu, select '*Manual settings*'. You must then choose whether to connect using '*Wired*' or '*Wireless*' connections. If you choose '*Wireless*' there are as many as nine settings screens, shown by the '*1 of 9*' progress marker in the top right corner of the display. If you choose '*Wired*' there are five screens and the progress marker will reflect this, although the steps to set up the network parameters are basically the same.

2. The next menu asks whether you wish to use DHCP to configure your network parameters (IP address, subnet mask, gateway address, etc.). Unless you are familiar with networking and related terminology, we recommend that you allow the use of DHCP. Choose '*DHCP enable*' unless you need to specify the network details manually.

If you have chosen '*Wired*' and then '*DHCP enable*', your radio should now establish a connection to the router using the Ethernet cable. Please skip to step 11 on page 20.

If you chose '*Wireless*' and '*DHCP enable*', please skip to step 6 on page 19 in order to set up the wireless connection details.

If you chose '*DHCP disable*' for either connection method, the next step is to set up the IP address.

3. The manually specified IP address should be chosen to be compatible with the settings in your router and must be a unique address on your network. If you are using DHCP for some devices and static (manually configured) IP addresses for others, the IP address used should fall outside the range that the router may allocate using DHCP. Typically, the first three groups of digits will be the same for all devices on your network. To enter the IP address, rotate the **Tuning/Select** control to set the value for each group of digits and then press the control to enter the value and to move on to the next group. When the IP address has been entered, the subnet mask should be entered. The subnet mask defines which parts of the IP address are common across your network. For most small networks the subnet mask will be 255.255.255.0 and this is entered in the same way.

4. The Gateway address is normally the IP address of the router through which the radio connects to the internet and is entered in the same way as the previous addresses.

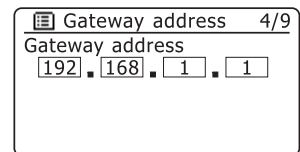
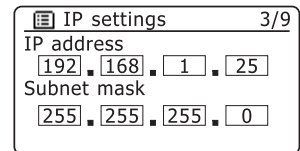
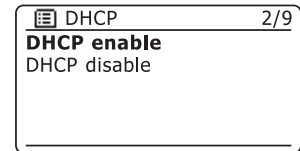
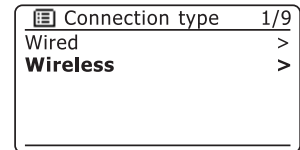
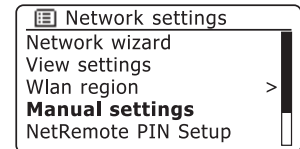

Manual network configuration - cont.

- In most installations the DNS settings (DNS = Domain Name Server) will be set to the same IP address as your router. In this case the secondary DNS may be left at zero.

To enter the DNS address, rotate the **Tuning/Select** control to set the value for each group of digits and then press the control to enter the value and to move on to the next group. Repeat this until all eight groups of digits have been entered.

If you previously specified 'Wired' and then 'DHCP disable', your radio should now connect to the router using the Ethernet cable (in which case skip to step 11).

- If you specified 'Wireless', the next step is to set up the WiFi connection, starting with the name of the wireless network (SSID) followed by the encryption options and password.

To enter the SSID, characters are selected and entered using the **Tuning/Select** control. As you rotate the control, the radio scrolls through the available characters as well as the three controls on the right. The character currently highlighted will be entered when you press the **Tuning/Select** control.

Do this as needed until the complete network name has been entered. *The SSID setting is sensitive to upper and lower case characters and symbols. You must enter it exactly as set up in your router.*

The three controls on the right-hand side of the screen have special functions. You can quickly access these by pressing the **Info** button and then use the **Tuning/Select** control as needed:

- select '**BRSP**' to erase a character just entered (long press to clear); **Info** again to continue
- select '**OR**' when the complete SSID has been entered
- select '**CANCEL**' to cancel and go back to the DNS settings screen

- Having entered the SSID, you must enter details of the encryption system used on your wireless network. This should be the same as specified in your router settings. If your network does not use encryption, then select the 'Open' option. Your radio should then connect to the network, so skip to step 11. If your network uses WEP (Wired Equivalent Privacy) select the 'Pre-Shared Key' option then go to step 8. The remaining options are for WPA or WPA2 (WiFi Protected Access) - see step 9.

- If you chose 'Pre-Shared Key' in step 7, you should then choose the WEP option. The key should be entered using only the numbers 0-9 and the letters A-F. The key will be 10 characters long for 64-bit encryption and 26 characters long for 128-bit encryption. The radio will accept lower-case letters a-f as equivalent to upper-case A-F. Spaces or special symbols are not permitted in WEP keys.

DNS 5/9
Primary DNS
192 . 168 . 1 . 1
Secondary DNS
0 . 0 . 0 . 0

SSID 6/9
mynetwork
0123456789 . _ - @ . **BRSP**
a b c d e f g h i j k l m n
o p q r s t u v w x y z A B C **OR**
D E F G H I J K L M N O P Q R **CANCEL**

Authentication 7/9
Open
Pre-Shared Key
WPA
WPA2

Encryption type 8/9
Disabled
WEP

Key: 9/9
01234ABCDE
0123456789 . _ - @ . **BRSP**
a b c d e f g h i j k l m n
o p q r s t u v w x y z A B C **OR**
D E F G H I J K L M N O P Q R **CANCEL**

Manual network configuration - cont.

The three controls on the right-hand side of the screen have special functions. You can quickly access these by pressing the **Info** button and then use the **Tuning/Select** control as needed:

- select '**BACKSP**' to erase a character just entered (long press to clear); **Info** again to continue
- select '**OK**' when the complete encryption key has been entered
- select '**CANCEL**' to cancel and go back to the SSID settings screen

Once the key is entered the radio should connect to your network. Please skip to step 11.

9. WPA and WPA2 are similar, although WPA2 offers a higher level of security. Whichever you selected in step 7, you then have to specify the variant used. They are TKIP (Temporal Key Integrity Protocol) and AES (Advanced Encryption Standard). As previously, the setting should match that used by your router. Some routers allow both to be specified, and the router will use whichever variant is supported by the connected device. AES is regarded as the more secure option if it is available.

10. The radio will then require you to enter the encryption key. This must be a string of between 8 and 63 characters and must be identical to the key which has been entered into your router. *Note - the encryption key is sensitive to the use of upper and lower case letters and symbols. Take care to enter the key exactly, or the radio will not be able to connect to your router.*

The three controls on the right-hand side of the screen have special functions. You can quickly access these by pressing the **Info** button and then use the **Tuning/Select** control as needed:

- select '**BACKSP**' to erase a character just entered (long press to clear); **Info** again to continue
- select '**OK**' when the complete encryption key has been entered
- select '**CANCEL**' to cancel and go back to the TKIP / AES options screen

Once the key is entered the radio should connect to the network.

11. While the radio is trying to connect to the network, it will display '*Processing...*' when checking the encryption key (if using the WiFi connection) and then '*Connecting...*'. If the connection is made successfully, the radio will return to the Network settings menu. If the unit cannot connect, then it will display a '*Failed to connect*' message and will return to the SSID entry screen (step 6).

Once connected, the network settings are stored in the radio. The settings are retained when the radio is disconnected from the mains.

You may now use the **Back** and **Mode** buttons to access the functions of your radio.

Configuration

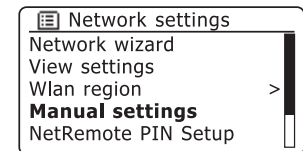
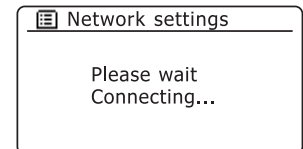
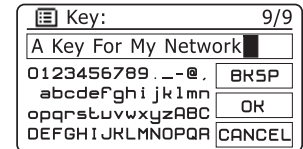
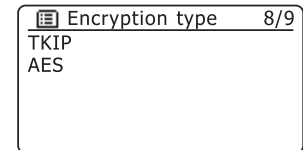
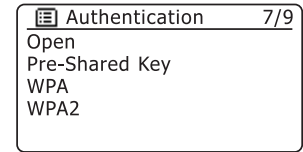

Network remote control options

Network PIN setup (PIN number)

Your radio has the option of being controlled by an application installed on an Apple iPhone, iPod touch or iPad. The PIN number facility allows you to ensure that your radio can only be controlled by your own Apple device rather than someone else's.

Details of how this feature can be used with your iPhone or iPod touch are explained in the separate documentation available from the Roberts Radio Website. The remote control app is called ConnectR and is available from the Apple App Store.

Keep network connected

By default, your radio will shut down its WiFi or Ethernet connection when it is in standby. This minimises power consumption but it does mean that you will need to switch the radio on manually in order to use either the 'Play to' function or any other remote control software.

If you need to be able to remotely control the radio even when it has been put into standby, then you can choose to keep the network connected by using the 'Keep connected' option in the network settings menu. In the standby mode display either the WiFi signal indicator is shown with or without a cross through it, or the Ethernet connection is shown unplugged or plugged in according to the chosen network settings.

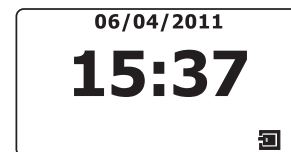
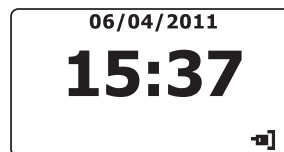
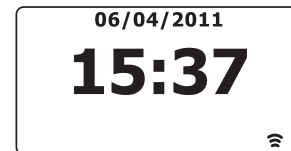
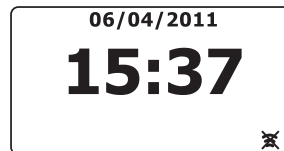
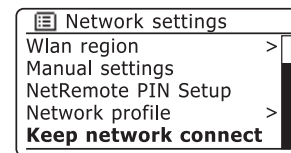
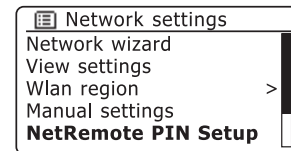

Internet Radio - the basics

Before you can use your radio to listen to broadcasts via the Internet, it is necessary to have connected it to your computer network using either the wireless (WiFi) connection or the wired Ethernet connection (RJ-45 socket) located on the back of the unit. Please see page 10 for details.

There are literally many thousands of radio broadcasts available via the Internet as well as 'Podcasts'. Your radio provides several ways of searching for broadcasts in order to make finding and choosing them easier. Once you have found radio stations which you like, you may either store them as presets within the radio, or add them to a list of your favourite stations which your radio can access. The number of presets is limited (there are five preset buttons on the radio), but you can store as many favourites as you like.

You may search for an internet radio station by Location. If you know the name of the station and the country from which a station is broadcast this may be the easiest method to find a station. It is also a great way to experience radio from other parts of the world.

You may also search for an internet radio station by Genre. If you prefer a particular type of music, Blues for example, you may search for a radio station that broadcasts that type of music, and you can choose from a list of Blues radio stations regardless of location, or taking location into account.

If you know part of the name of an internet radio station, you can enter it into the radio and it will search for stations that match that name. This can be helpful if you are unsure of the location or genre of a particular station.

The Stream 205 radio connects to a radio station database which serves many users in many countries. This means that there is a very wide range of programme content available. You can also search for stations which have been recently added to those available (new stations) or you can search for the most popular.

Selecting a radio station by location

1. Press the **On/Off** button to switch the radio on. Then press the **Mode** button to select the *Internet radio* mode display.
2. Press the **Menu** button to enter the main *Internet radio* menu. Rotate the **Tuning/Select** control until '*Station list*' is highlighted on the display and then press the control to select the option.
3. Rotate the **Tuning/Select** control until '*Stations*' is highlighted on the display and then press the control to select.
Note that the menu may offer one or more local selections based upon the country in which the unit is being used, according to your internet IP address ('*United Kingdom*' and '*BBC*' stations, for example).
4. Rotate the **Tuning/Select** control until '*Location*' is highlighted on the display and then press the control to select.
5. Rotate the **Tuning/Select** control to scroll through the list of continents. When the desired continent is highlighted press the control to enter your selection.
6. The display will show a list of countries within the chosen continent. If there are many countries shown you can scroll through the list continually in either direction. For example, if the chosen continent was Europe, then to find the United Kingdom scroll up from the top of the list to the bottom by turning the **Tuning/Select** control anti-clockwise. Press the **Tuning/Select** control to choose the desired country.
7. You will typically find that you then have the option to select either '*All Stations*' or one of a number of categories. The lists are always sorted alphabetically, and long lists will wrap around from top to bottom or bottom to top.

Mode

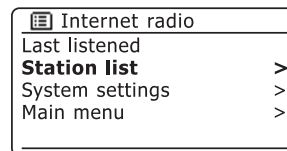

Menu

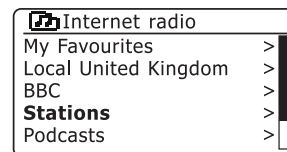

Select/
Snooze

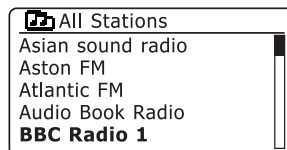
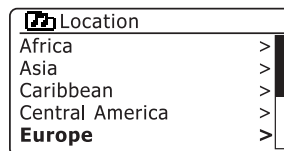
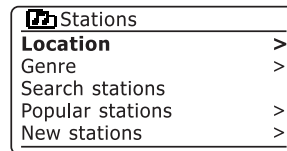
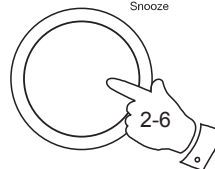

Selecting a radio station by location - cont.

- Rotate the **Tuning/Select** control to highlight your chosen radio station and then press the control to enter your selection. The display will show 'Connecting...' while the radio connects to the new station. The station should then start playing. Adjust the volume as needed.
- If the station has on-demand content, that is, it gives the option of listening to programmes which have already been broadcast or to Podcasts, there will be an additional screen showing the radio station name as well as a 'Podcasts' option.

These are selected using additional menus, determined by the radio station and the content. There may simply be a list of programmes, or there may also be options to choose from broadcasts on particular dates or days of the week. The examples shown here are typical.

Podcasts and Listen Again content can also be accessed separately from the main Internet Radio menu, see page 28.

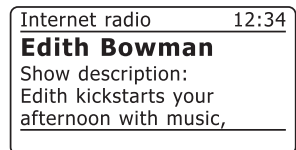
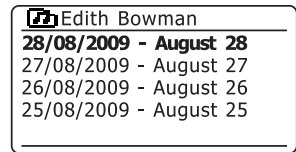
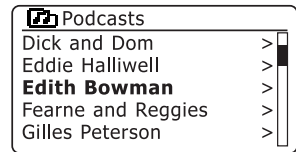
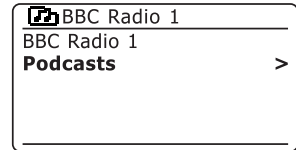
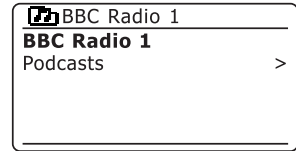
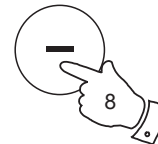
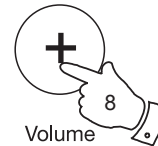
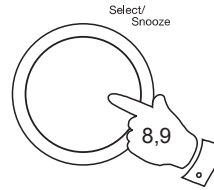

If your radio cannot connect to a radio station

Note: If your radio is unable to connect to an internet radio station it will generally either display 'Network Error' or 'Stopped'. This can be for many reasons, but typically will be due to one of the following:

The radio station may not be broadcasting at the present time.

The radio station may not be able to accommodate any more connections from internet listeners.

The broadcaster may limit listening to specific countries or regions

There may be network congestion (either locally or at a distance) which is affecting the reliability of the connection.

If your radio can connect, but the audio is not continuous and the radio keeps having to reconnect, this may be due to the radio station only having limited connection capacity.

Please also refer to the section 'Troubleshooting' on page 93.

Selecting a radio station by genre

1. Press the **Menu** button to enter the main *Internet radio* menu. Rotate the **Tuning/Select** control until '*Station list*' is highlighted on the display and then press the control to select.
2. Rotate the **Tuning/Select** control until '*Stations*' is highlighted on the display and then press the control to select.
3. Rotate the **Tuning/Select** control until '*Genre*' is highlighted on the display and then press the control to select.
4. Rotate the **Tuning/Select** control to scroll through the list of content types. This menu is normally cyclic - you can scroll the list continually in either direction. When the chosen genre is highlighted, press the **Tuning/Select** control.
5. You then have the choice of '*All Stations*' of the chosen genre, or a list of countries. Note if a country is not shown then the station may still appear in the '*All Stations*' list. Rotate and then press the **Tuning/Select** control to choose as needed
6. A list of radio stations is then shown. Rotate the **Tuning/Select** control until the desired station name is highlighted on the display.
7. Press the **Tuning/Select** control to select the station. The display will show '*Connecting...*' while it finds the new station. If the radio is unable to connect this may be for one of the reasons explained on page 24.
8. Adjust the **Volume** as needed to set the listening level.

Menu

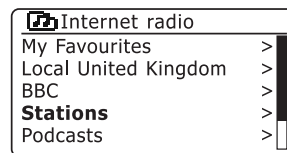

Select/
Snooze

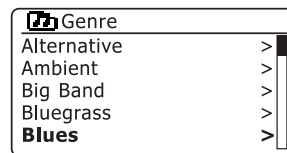
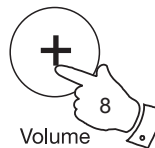
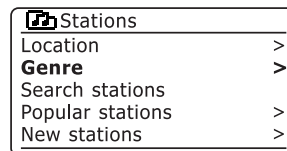
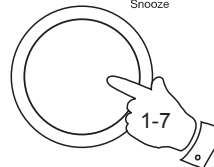

Volume

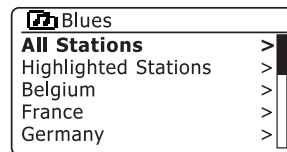
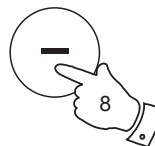

Searching for a radio station by name

There may be occasions when you know the name of a radio station but you do not know the location or genre. This facility allows you to search for the station using a part (or parts) of the radio station name.

1. Press the **Menu** button to enter the main *Internet radio* menu. Rotate the **Tuning/Select** control until 'Station list' is highlighted on the display and then press the control to select.
2. Rotate the **Tuning/Select** control until 'Stations' is highlighted on the display and then press the control to select.
3. Rotate the **Tuning/Select** control until 'Search stations' is highlighted on the display and then press the control to select.
4. To enter the search word(s) rotate the **Tuning/Select** control to highlight each character for the search in turn, and press the **Tuning/Select** control to enter. If you make an error rotate the control or use the **Info** button to access the delete character 'BKSP' on the screen and then press the **Tuning/Select** control. Rotate the control or press **Info** again to go back to the character selection. After the final character of the search has been entered, use the **Info** button and then the **Tuning/Select** control to highlight the 'OK' symbol on the screen and then press the control to finish. See also "Text Entry" page 9.
5. The radio will search for radio stations that match your search data. If you include a space between two search items the radio will look for station names which include both items. Thus a search for 'ROCK 100' could find a station called '100 Classic Rock Hits' as well as a station called '100.FM Rocks'
6. Rotate the **Tuning/Select** control to highlight the station that you wish to listen to and press the control to confirm your choice. The display will show 'Connecting...' while it finds a new station.

Menu



Select/ Snooze

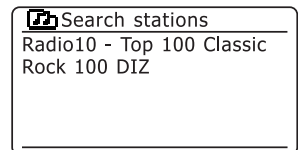
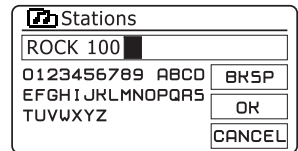
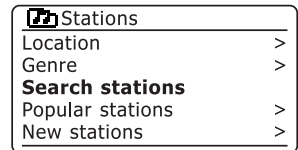
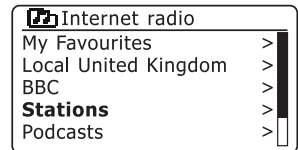
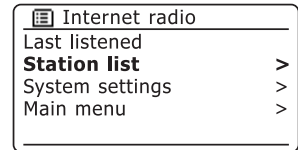
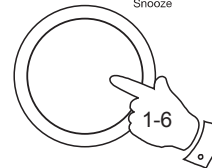

Selecting a new or popular station

As described in the section 'Internet Radio - the basics' on page 22, your radio connects via the Internet to a database of radio stations. This option is provided to highlight stations which are newly added to the list of those available, or stations which are particularly popular with listeners around the world. Your radio allows you to easily choose stations from these two categories, using menus very similar to those used when finding stations by location and genre.

1. Press the **Menu** button to enter the main *Internet radio* menu. Rotate the **Tuning/Select** control until '*Station list*' is highlighted on the display and then press the control to select.
2. Rotate the **Tuning/Select** control until '*Stations*' is highlighted on the display and then press the control to select.
3. Rotate the **Tuning/Select** control until '*Popular stations*' or '*New stations*' is highlighted on the display. Press the **Tuning/Select** control to enter your choice.
4. Rotate the **Tuning/Select** control to highlight the station that you wish to listen to and then press the control to enter your choice. The display will show '*Connecting...*' while the new station is found.

If the radio is unable to connect to a particular radio station this may be for one of the reasons explained on page 24.

Menu

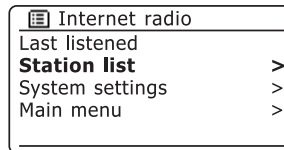

Select/
Snooze

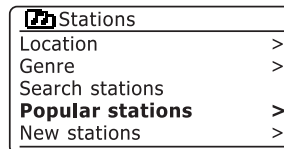
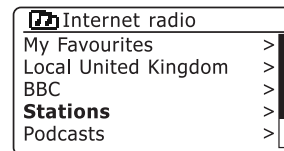
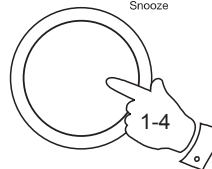

Selecting a podcast / BBC Listen Again

Some radio stations allow you to listen to programmes that have already been broadcast. The BBC's Listen Again service is an example of this. In addition, radio broadcasters and individuals may make programmes which are intended normally to be downloaded into a computer or copied onto a portable media player. These are commonly known as Podcasts.

On your radio, both Listen Again programmes and Podcasts are grouped together as Podcasts, and the same menu is used to access and listen to both types of programming. Listen Again programmes are also accessible via the *Stations* menu (see pages 23-24).

1. Press the **Menu** button to enter the main *Internet radio* menu. Rotate the **Tuning/Select** control until 'Station list' is highlighted on the display and then press the control to select.
2. Rotate the **Tuning/Select** control until 'Podcasts' is highlighted on the display and then press the control to select.
3. You may then search by location, genre, or using part of the name of the podcast. The searches operate in exactly the same way as when searching for a conventional radio station.

Searching by location is done first by continent, then by country. You may then list 'All shows' or search within a country by genre.

Searching by genre is more direct, since once the genre is chosen the next menu display shows a list of available podcasts.

Searching by name operates in the same way as when searching for a named radio station, selecting the 'OK' symbol when you have entered the text. You may enter one or more pieces of text which will be used for the search.

4. Rotate the **Tuning/Select** control and then press the control to confirm your chosen podcast. The display will show 'Connecting...' while it finds the new programme.

Menu



Select/
Snooze

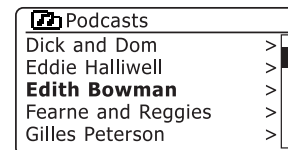
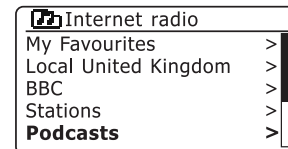
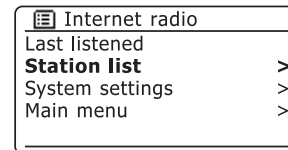
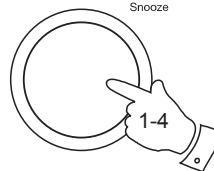

Presetting stations

With so many Internet radio stations available, it is desirable to have a means of rapidly selecting the stations that you listen to most frequently. Your radio has five memory presets which can easily be set to store the details of any Internet radio station. The radio station presets are retained in memory even when the radio is switched off.

Please see also the sections 'Last Listened' on page 30 and 'Configuring My Favourite Stations' on page 33.

Storing a preset

1. Press the **On/Off** button to switch on your radio. Tune to the required station using one of the methods described on the preceding pages.
2. To store the currently playing radio station as a preset, **press and hold** the required **Preset** button (1 - 5) until the display shows '*Preset stored*'. The station will be stored using the chosen preset button. Repeat this procedure as needed for the remaining presets.
3. Stations which are already stored in the presets may be over-written by following the above procedure.

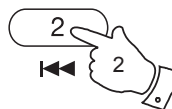
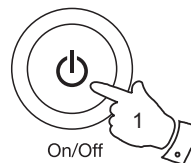

Recalling a preset

1. Press the **On/Off** button to switch on your radio. Select the *Internet radio* mode using the **Mode** button.
2. Momentarily press the required **Preset** button. Your radio will then connect to the station stored in preset memory. The preset used will be shown at the bottom of the display screen.

Mode

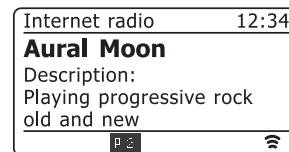

Last Listened

It is often helpful to be able to go back to a station that you have recently listened to. Your radio has a 'Last Listened' feature which provides you with quick access to the ten most recently listened to radio stations or podcasts. As each new radio station is listened to the oldest item is deleted from the list. The Last Listened list is stored when the radio is disconnected from the mains.

1. With the radio switched on and in *Internet radio* mode, press the **Menu** button. The first item on the menu is '*Last listened*'. With this item highlighted press the **Tuning/Select** control.
2. The display will then show a list of the last ten Internet radio stations or podcasts. Rotate the **Tuning/Select** control to highlight whichever you wish to listen to and then press the control to cause your radio to reconnect to that radio station or podcast.

Menu

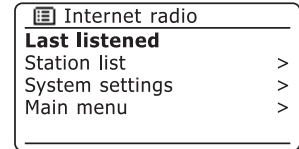

Select/
Snooze

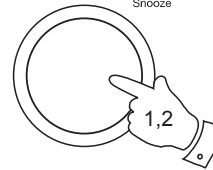

Display modes

Your radio has a range of display options when in Internet Radio mode. Note that not all information may be available for all Internet radio stations

1. Press the **Info** button to cycle through the different options.
 - a. Description

Displays information about the radio station or scrolling text messages such as artist/track name, phone number etc.
 - b. Genre

Displays programme type information e.g. Pop, Classic, News, etc. and the location of the current radio station.

Info

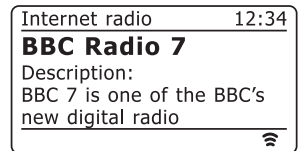
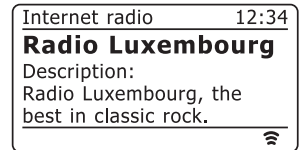

Display modes - cont.

- c. Reliability Displays the reliability of the data stream from the station currently being received.
- d. Format Displays the bit rate and format of the station being received.
- e. Playback buffer Displays status when connecting to and playing a radio station. This indicates the reliability of the data stream to your radio. If there are no bars shown to the right of the dividing line then the data stream reliability may be poor and you may find that there are many breaks in the audio (this is not always the case for REAL audio streams).
- f. Date Displays the current date.

Additional or alternative information may be displayed when listening to Podcasts. Categories displayable can include...

Episode name	Show description
Show genre	Show language
Episode URL	Bit rate
Codec	Sampling rate

Whenever the sound system is displaying an information screen (as opposed to a menu screen), the time is displayed in the top-right corner of the display, and a WiFi strength or Ethernet connection indicator is shown in the bottom-right corner.

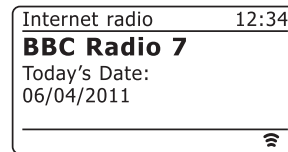
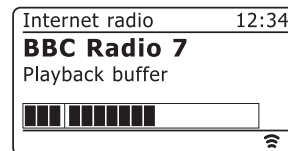
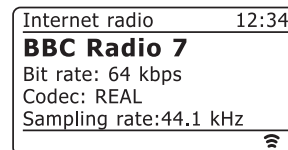
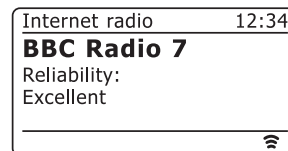

Customising your radio

In addition to storing your favourite radio stations in the radio presets, your radio allows you to create customised lists of stations which can appear in two special menus on the radio called '*My Favourites*' and '*My Added Stations*'.

Your radio uses a database which is accessed via the Internet in order to find out which radio stations are available and how it should connect to them. You are able to add your personal selections to this database. These will only be accessible by you using your PC or your radio. You can choose the stations which will appear in the '*My Favourites*' menu from the large selection already listed. Additionally, if you find a radio station that is not listed then you may also add the Internet address (URL) of the station's audio stream to your selection. It will then appear on your radio via the '*My Added Stations*' menu item.

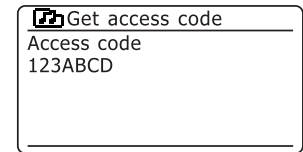
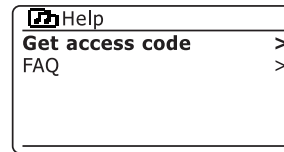
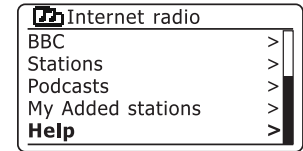
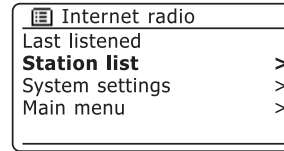

Registering an account

1. Open the web site <http://www.wifiradio-frontier.com> using the Internet browser on your computer. Click on the '*Register here*' link and follow the on-screen instructions to register an account. During the registration process the web site asks for an access code. This allows it to uniquely identify your internet radio from the many others that it also provides data for. To obtain the access code, please follow these steps.
2. With your radio switched on and in Internet radio mode, press the **Menu** button, then select '*Station list*' using the **Tuning/Select** control.
3. Scroll down the Station list menu to the item called '*Help*'. Press the **Tuning/Select** control to enter the Help menu.
4. In the Help menu, select the menu item '*Get access code*'. Provided that the radio is connected to the Internet, a code will be displayed of typically seven characters (upper case letters and numbers). Make a note of this code for the next step. If you need to re-register later you must repeat this process to get a fresh access code.
5. You should then use the code displayed by the radio to fill in the Access Code field on the web page when you set up your account.

Once you have your account set up, if you have other radios which use the same database, you may also add them to your account. You will need to get an access code from each radio in order to add it to the account. They may then share your favourite and added radio station details.

Customising your radio - cont.

Configuring My Favourite Stations

1. Using the web site at <http://www.wifiradio-frontier.com> it is possible to search among the many radio stations that are available by location, genre, or language. You may also choose from new or popular stations.
2. When the radio stations that you have found are shown on your computer screen, they are shown with a 'Play' icon and an 'Add to favourites' icon (the plus symbol and heart). Clicking on the 'Play' icon will allow you to hear the radio station via your computer. Clicking on the 'Add to favourites' icon will cause the radio station to be added to the list accessible via your radio.
3. To help you organise your favourites, and since you may have a great many after a while, the web site will allow you to specify the name for a category or group under which the radio station will be listed on your radio. Suitable names might be 'Rock', 'Smooth', 'Mum's stations', and so on. When ever you add another radio station to your favourites you can either add it to an existing category or create a new one.
4. Once you have Internet radio stations available in your My Favourite Stations list, you may play these stations from your radio. These stations will be available on your radio from the Internet radio menu item *'My Favourites'*.
5. To look at, modify or delete your favourite stations lists on the web site, use the link *'My favourites'* in the *'My account'* area. To delete a favourite radio station, click on the icon with a heart and minus symbol.

Configuring My Added Stations

1. If you wish to listen to a radio station which is not currently held in the database at <http://www.wifiradio-frontier.com> it is possible to add the details yourself. You will need to obtain the internet address (URL) for the audio stream for the station that you wish to add. This may be information provided by the radio station itself, via its web site, or perhaps passed to you from another listener.
Note: The URL for the audio stream will generally **not** be the URL for the web page from which you listen to the station on your PC.
2. Use the *'My added stations'* link in the *'My account'* area on the web site. This allows you to add details of new stations or to modify those already added. You can provide a name for the radio station which will be shown on your radio. You must also provide the web address, location and format details.
3. Once you have Internet radio stations available in your My Added Stations list, you may play these stations from your radio. These stations will be available on your radio from the Internet radio menu item *'My Added Stations'*.
4. It is possible to add the web addresses for audio streams which may not be playable by your radio. If you attempt to play such a stream, your radio will normally display an error message of some kind. The Roberts Stream 205 can only play MP3, WMA, FLAC, AAC and Real Audio streams.
5. To look at, modify or delete your added stations list on the web site, use the link *'My added stations'* in the *'My account'* area. To delete an added radio station, click on the icon with a heart and minus symbol.

Selecting your favourite stations

1. Press the **Menu** button to enter the main *Internet radio* menu.
2. Rotate the **Tuning/Select** control until 'Station list' is highlighted on the display. Press the **Tuning/Select** control to enter the menu.
3. Rotate the **Tuning/Select** control until 'My Favourites' is highlighted on the display. Press the **Tuning/Select** control and your favourite stations list will appear on the display (set up as described on the preceding page).
4. Rotate the **Tuning/Select** control to highlight the required station and then press the control to confirm your selection.

The display will show 'Connecting...' while it finds the new station.

If the station has on-demand content (that is, it gives the option of listening to programmes which have already been broadcast), please see page 28, 'Selecting a podcast / BBC Listen again'.

Should you be unable to connect to a particular station, please note that some radio stations do not broadcast 24 hours per day, and some stations are not always on-line.

Menu



Select/
Snooze

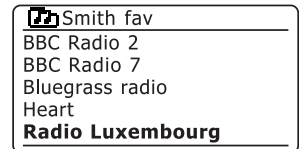
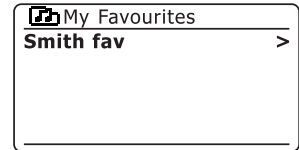
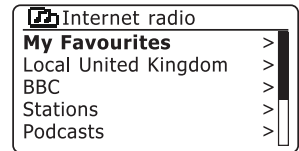
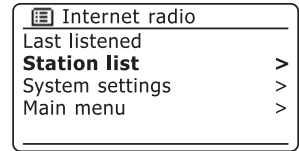
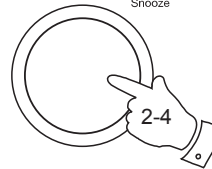

Selecting your added stations

1. Press the **Menu** button to enter the main *Internet radio* menu. Rotate the **Tuning/Select** control until 'Station list' is highlighted on the display and then press the control to select.
2. Rotate the **Tuning/Select** control until 'My Added Stations' is highlighted on the display and then press the control to select.
3. Rotate the **Tuning/Select** control to highlight the required station and then press the control to confirm your selection.

The display will show 'Connecting...' while it finds the new station.

Should you be unable to connect to a particular station, please note that some radio stations do not broadcast 24 hours per day, and some stations are not always on-line.

In addition, as mentioned on page 33, it is possible to specify audio streams for 'My added stations' which are not compatible with your radio. In this event the station will not be playable. The Roberts Stream 205 can only play MP3, WMA, FLAC, AAC and Real Audio streams.

Note that the audio coding formats listed are generic terms. There are many variations of each format, as well a variety of streaming protocols in use by different radio broadcasters. Your radio has been designed to play the majority of coding and streaming formats in current use by broadcasters.

Menu



Select/
Snooze

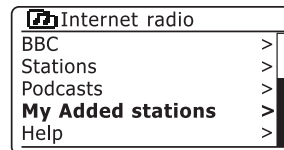
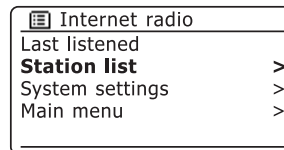
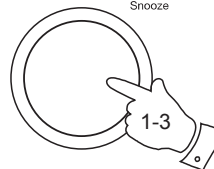

Use with Windows, Apple Mac, Linux, USB memory

The Music Player allows you to play audio files which are stored on a computer on your network or on a USB memory device plugged into the radio.

In order to play files from a computer on your network, your radio must connect to a file server application which uses the Universal Plug and Play (UPnP) protocol. If your computer uses Windows 7, Vista or XP then it is likely that your computer already has a UPnP server application available. Windows Media Player (versions 11 and 12) has this capability, and it is able to make your files available to your radio. It also allows you to select files by Album, Artist, and so on.

Windows Media Player 12 can serve MP3, WMA, AAC and WAV files to your radio. Windows Media Player 11 is only able to serve MP3 and WMA files to your radio. If you have your audio files stored in the FLAC format, or if you are an Apple Mac or Linux user, there are other UPnP server applications which you may use with your radio.

The Music Player on the radio can playback audio files in MP3, WMA, AAC, FLAC and WAV formats. WMA Lossless files can also be played when using Windows Media Player as it will convert these to a compatible format before streaming them to the radio. Note that the playback of files encoded using WMA Voice, WMA 10 Professional, and of files which have DRM protection is not supported.

When using a UPnP server, the search and selection criteria are determined by the server software, but typically include Artist, Album and Genre. Many server applications also allow you to access your files according to the folders within which they are stored as well as other criteria. Windows Media Player is less flexible than some other UPnP servers, but is generally easier to set up. It is supplied as a standard component of Windows 7, Vista or XP.

Many UPnP server applications are also capable of sharing pictures and video files to other network connected devices. If this is the case (as it is with Windows Media Player 11 and 12) you may see the option of choosing between 'Music', 'Video' and 'Pictures' on the Music Player's menu. Clearly you should only select the 'Music' option. Content offered via the alternative options will not be playable on your radio.

Some third party server applications allow customisation of the search criteria and indexing methods. This can be useful if you have a very large collection of stored music files.

Here is a short selection of alternative UPnP server applications, although many others are available:

Twonky Media Server (Windows, Apple Mac, Linux)

TVersity (Windows) *

Elgato EyeConnect (for Apple Mac OS X) *

MediaTomb (Linux, Mac OS X) *

* = free of charge versions available at the time of writing

Please refer to the documentation for your chosen server application for full details of its configuration and usage.

Accessing your audio files via a UPnP server

If your computer is running Windows 7, then Windows Media Player (version 12) includes a UPnP server which will make your audio files available to your radio. If you have Windows Vista or XP please see page 95. There are other UPnP server solutions available for non-Windows users and for Windows users who may wish to use an alternative (see the preceding page).

It is beyond the scope of this instruction book to cover all possible options for UPnP. We explain the use of Microsoft's Windows Media Player here since that will be the first choice for the majority of users.

Set up UPnP access with Windows Media Player 12

1. Windows Media Player 12 (referred to here as WMP 12) can create a library from all the media files available to it on your PC. To add new media files to the library, select '*Library*', then '*Music*', then '*All music*' or '*Artist*', '*Album*' etc. This will show you the current library contents. You may then simply drag and drop files from other locations into the library. Alternatively, with media files or folders on the screen, you may right-click on the file or folder and select '*Include in library*' and then select '*Music*'. In this way you can quickly add additional content to your music library.
2. In WMP 12, click on '*Stream*' (see picture at right) and then select '*Automatically allow devices to play my media*'. Then accept the '*Automatically allow all computer and media devices*' option. There are other options (see overleaf) but this is the simplest if you just wish to quickly enable media streaming to your radio.
3. Press the **On/Off** button to switch the radio on. Then press the **Mode** button as needed until the *Music Player* mode display is shown. The main '*Music Player*' menu will then be displayed.

Enabling Media Streaming in Windows Media Player 12

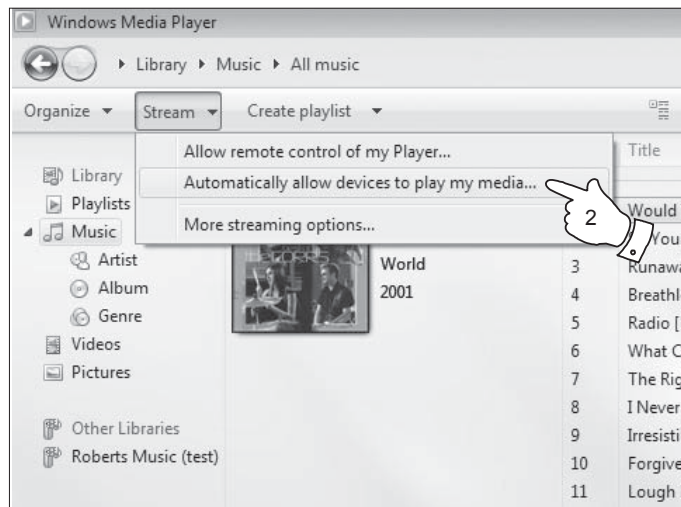

Mode



Set up UPnP access on a Windows PC - cont.

4. Rotate the **Tuning/Select** control until *'Shared media'* is highlighted and press the control to select. The radio will scan for all available UPnP servers. It may take a few seconds for the radio to complete its scan. The radio will display '<Empty>' if no UPnP servers are found.
5. After scanning, select your UPnP server using the **Tuning/Select** control. If you allowed automatic connection previously, your radio should now connect and you may skip to the next page.
If you did not permit automatic connections, your radio will then normally display *'Unauthorised'* at this stage.

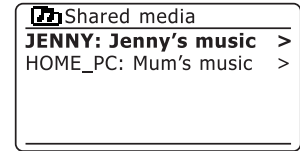
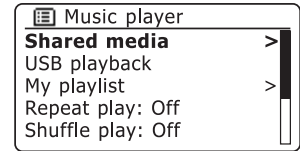
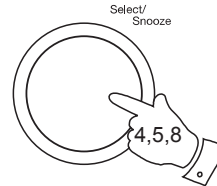

6. Your PC may prompt you that there has been a connection to your UPnP server. Whether prompted or not, in order that the radio may access the music files, you will need to click the *'Library'* tab in WMP 12 and select the *'Stream...'* item to open the *'Media Streaming'* window. Select *'Automatically allow devices to play my media'* then select *'Automatically allow all computer and media devices'*.

Alternatively select *'More Streaming options'* to enable sharing on a 'per device' basis.

7. In the *'More streaming options'* window, the radio will be listed as a blocked device. Click on the button shown to select *'Allowed'*.

Note: If you are using Microsoft's Windows' firewall software, this should be correctly configured by WMP 12. If you are using third party firewall software you may need to manually configure it to allow your unit and WMP 12 to communicate (see the 'Troubleshooting' section on page 93).

8. On the radio, select the named server again using the **Tuning/Select** control. If WMP 12 is now able to communicate with your radio you will be presented with some media selection options on the display.

Allowing a device to connect to Windows Media Player 12

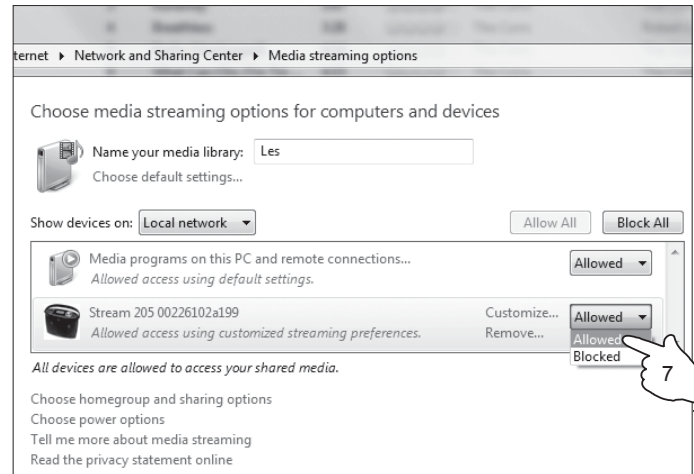

Locating and playing media files using UPnP

Once the UPnP server has been configured to share media files with your radio, you may select the files that you wish to play as follows:-

1. Press the **On/Off** button to switch on the unit. Press the **Mode** button as needed until the *Music Player* mode display is shown. The main Music Player menu will then be displayed.
2. Rotate the **Tuning/Select** control until '*Shared media*' is highlighted on the display and then press the control to cause the radio to scan for UPnP servers. Note that it may take a few seconds for the radio to complete its scan. The display will return to the Music Player menu if no UPnP servers are found.
3. After a successful scan, rotate the **Tuning/Select** control to highlight your UPnP server and then press the **Tuning/Select** control. If the display shows multiple media types, select '*Music*'. (Some UPnP servers can serve pictures and video content to suitable devices.)
4. The radio will now list the media categories which are made available by the UPnP server - for example, '*Album*', '*Artist*' and '*Genre*'. Rotate the **Tuning/Select** control to highlight which category you wish to browse, then press the control to confirm your choice.

If you wish to use the search function rotate the **Tuning/Select** control until '*Search*' is selected on the display. You may select characters to build a keyword for searching for content to play.

When you first set up sharing with a UPnP server, not all of your files will be available immediately. The UPnP server must look inside each file to identify the artist and album information from 'tags' embedded in them. The server may also need time to access the Internet to obtain additional information such as 'album art' which it can display when you examine your music library on your PC. For a library of many files this can take some time.

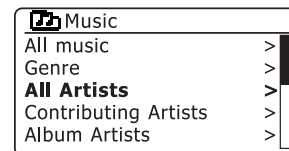
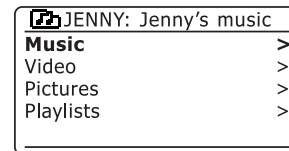
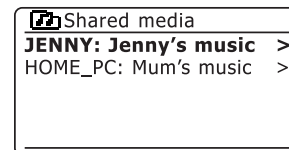
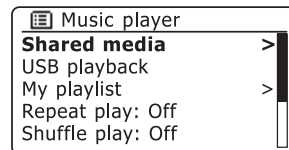
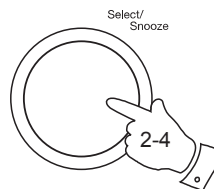
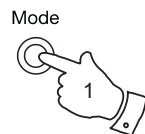
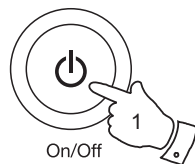

Media selection

When searching via UPnP you will have a selection of search criteria as determined by the UPnP server software on your computer. This allows you to search by a given information type (Album, Artist, Genre, etc.) and then to narrow the search to an album or to a particular track within an album.

Some UPnP server applications allow the search options to be customised. The searches described here are just examples of the possibilities.

Listening to a complete album

1. Use the **Tuning/Select** control to choose content by Artist, Album, Genre, etc. according to your needs then press the control to enter your choice.
2. When you reach the album or folder the menu will then switch to showing the tracks in that album or folder. When searching by UPnP they will normally be listed in track number order (but as with the search criteria, this can vary according to the server application used).
3. With the first track in the album indicated, press the **Tuning/Select** control. The album will then begin playing.

While the radio is playing from your media library, you may use the menus as described above to choose a different selection. When you select the track from which to play, the radio will then immediately begin playing the new selection.

Please see also 'Playlists' on page 46.

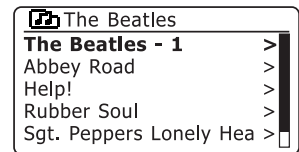
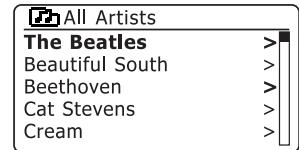
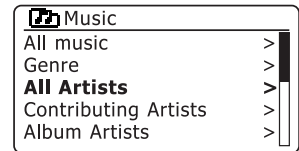
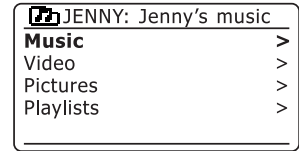
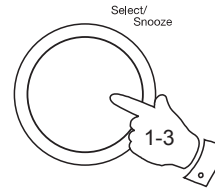

Listening to a particular track

1. If you wish to play only a particular track from an album or folder, first choose the album or folder as described on the preceding pages.
2. Rotate the **Tuning/Select** control until the required track is highlighted.
3. Press and release the **Tuning/Select** control. The track will begin playing. The radio will then play subsequent tracks from the same album or folder.

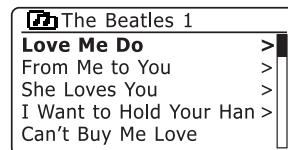
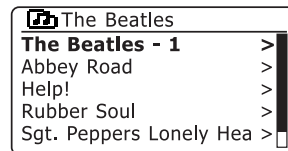
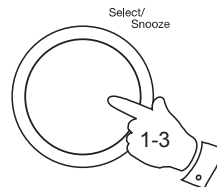

Controlling playback

1. Press the **Pause** button to pause playback of the current track.
2. If you press the **Play** button, playback will resume from the point where it was paused.
3. Press the **Rewind** button to start playback of the previous track in the list.
4. Press the **Fast-forward** button to start playback of the next track in the list.
5. Press and hold the **Fast-forward** or **Rewind** button to move through the current track. The longer the button is pressed, the greater the speed at which the player will move through the track. Release the button when the desired point is reached. (Note that this feature is not supported when playing files encoded using the FLAC format.)

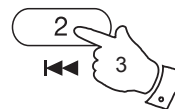
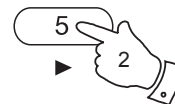
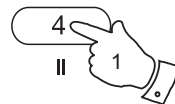

Controlling playback cont.

Repeat tracks

1. Ensure you are in the main *Music Player* menu.
2. Rotate the **Tuning/Select** control until '*Repeat play*' is highlighted.
3. To activate the repeat option press the **Tuning/Select** control so that '*On*' appears on the display. Your selected tracks will be played repeatedly and the repeat indicator will show on the display.
4. To turn off the repeat option highlight '*Repeat play*' and press the **Tuning/Select** control so that '*Off*' appears on the display.

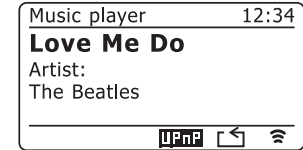
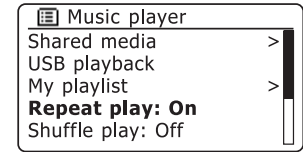
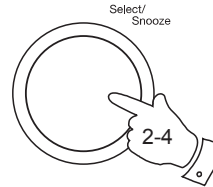

Play tracks in random order

1. Ensure you are in the main *Music Player* menu.
2. Rotate the **Tuning/Select** control until '*Shuffle play*' is highlighted.
3. To activate the random option press the **Tuning/Select** control so that '*On*' appears on the display. Your selected tracks will be played in random order and the random indicator will show on the display.
4. To turn off the random option highlight '*Shuffle play*' and press the **Tuning/Select** control so that '*Off*' appears on the display.

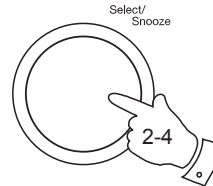

If both Repeat and Shuffle play options are set to '*On*' then both Repeat and Shuffle icons will be shown in the display.

Note: The shuffle play function may only be used if the current selection comprises fewer than 500 tracks.

Display modes

Your radio has a range of display options when in *Music Player* mode. Note that the availability of information depends on the specific media files, their format and upon the server capability. (Not all UPnP servers make information from the media files available in the same way.)



1. Press the **Info** button to cycle through the different options.

- | | |
|-----------------|--|
| a. Progress bar | Displays the playback progress for the track currently playing (time info not displayed for FLAC files). |
| b. Artist | Displays the artist information for the track currently playing. |
| c. Album | Displays the album information for the track currently playing. |
| d. Format | Displays the bit rate and format of the track currently playing. |
| e. Buffer | Displays the radios internal buffer status during media playback. |

Whenever the Music Player is displaying an information screen (as opposed to a menu screen), the time is displayed in the top-right corner of the display, and a WiFi strength or Ethernet connection indicator is shown in the bottom-right corner together with an indicator showing the method by which the radio is obtaining the media - either from a UPnP server or USB memory.

If the capture of track information by the Last.fm feature is enabled (known as scrobbling), then the Last.fm logo will also be shown (see pages 52-61).

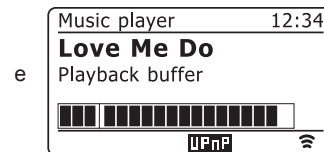
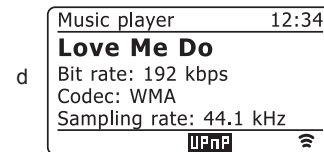
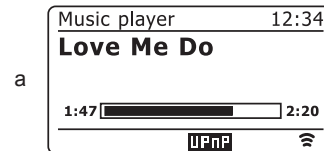

Using USB memory devices

This section describes how to use your radio to access and playback your audio files via USB memory devices.

USB memory devices plug into the rectangular slot on the rear of the radio.

Important: Your radio is only designed to work with USB flash memory devices. It is not intended to be connected to hard disk drives or any other type of USB device.

The Stream 205 radio has been tested with a range of USB memory devices of up to 120GB capacity. USB memory must use the FAT or FAT 32 filing system in order to operate with the radio.

It is possible to use SD or SDHC cards for media storage and playback when held in a suitable USB adaptor. However, due to the wide variation of such adaptors, it is not possible to guarantee that all adaptor / card combinations will work in the radio.

Audio formats supported are MP3, WMA, AAC, FLAC and WAV.

USB playback does not support files encoded using WMA Lossless, WMA Voice, WMA 10 Professional, nor files of any format which have DRM protection.

Recommendations:

Unless you have only a few files on the USB memory device, do not place all files in the root folder.

The number of items (files/sub directories) in any directory should be less than 2000.

Searching and playback will be more responsive if the number of files in any one folder is limited (we suggest not more than 250).

It is recommended that the USB memory is reformatted in your computer before adding your music files.

The maximum depth of folder nesting permitted is 8 directory levels (but playback is only from the currently selected folder).

Shuffle and Playlist functions are limited to 500 tracks.

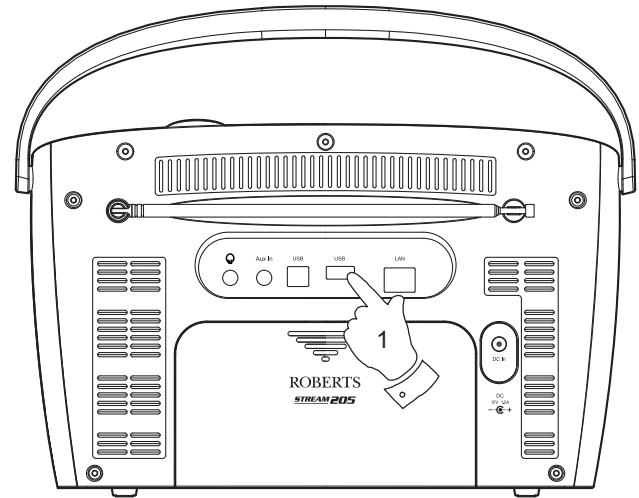

Cautions:

In order to minimise the risk of damage to your radio or your USB memory, please place the unit such that the memory device cannot easily be knocked while it is inserted in the socket. Take care to avoid knocking the USB memory device with the radio's carry handle.

Remove the USB memory before carrying the unit or if not using the USB feature for a prolonged period.

Place the unit in Standby mode before removing your USB memory device.

Playing files from USB memory devices

1. Carefully insert the USB memory device into the USB slot. Press the **On button** to switch on the radio.

The radio may detect that the memory has been connected, in which case it will ask whether you wish to open the folder view of the memory contents. Press the **Tuning/Select** control to select 'Yes' and skip to step 4 below.

If the USB memory was not automatically detected, proceed as follows.

2. To select USB playback mode press the **Mode** button as needed until the *Music Player* mode is selected.

Mode



3. Rotate the **Tuning/Select** control until '*USB playback*' is highlighted on the display and press the control. The radio will now list the content stored on the USB memory device. If there are many files or folders this may take a few seconds.

Select/
Snooze

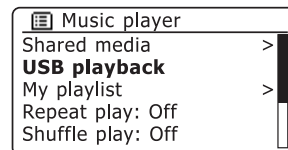
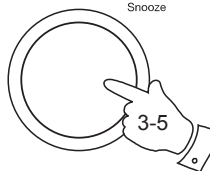

4. Rotate the **Tuning/Select** control to highlight the required folder and press the control to enter the current folder. The list of tracks in the current folder will be displayed.

Alternatively, if you have nested folders (such as album folders within an artist folder) then you will simply step to the next folder level.

5. Rotate the **Tuning/Select** control to select the track and press the control to begin playing from the highlighted track. All files in the current folder will then be played in turn.

Files are sorted by filename in numeric-alpha order (0...9...A...Z) before being played.

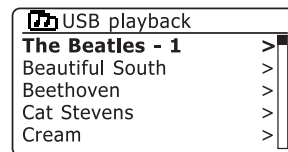

6. Controlling playback from the USB memory device including Shuffle and Repeat functions is explained on pages 41 and 42. The shuffle play function may only be used if the current selection comprises fewer than 500 tracks.

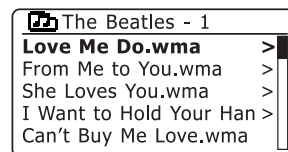

Playlists

Sometimes you may wish to set up a list of music tracks or albums which can then be played without further action - as background music for a party, for example.

Your radio can be configured to hold a queue of up to 500 tracks in a playlist menu. The tracks or albums for the playlist can be selected from your UPnP server and from a USB memory device.

The playlist is held in memory in your radio until external power is removed, or until the playlist is cleared from the menu.

Note that the playlist is not retained in stand-by mode when the radio is running on batteries.

Adding a single track to your playlist

1. When selecting (or when playing) a track using a UPnP server or a USB memory device **press and hold** the **Tuning/Select** control and the display will show 'Added to My playlist'.
2. The track will be added to the playlist for playback later.

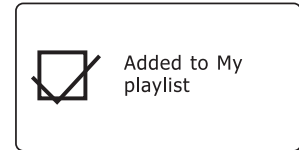
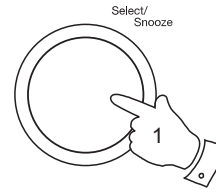

Adding an entire album or folder

3. When using a UPnP server or a USB memory device highlight the chosen album, artist or folder and **press and hold** the **Tuning/Select** control. The display will show 'Added to My playlist'.
4. Each of the tracks within the album, artist or folder selection will be added to the playlist individually. This allows any unwanted tracks to be removed from the playlist if needed (see next page).

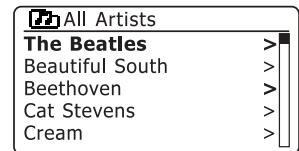
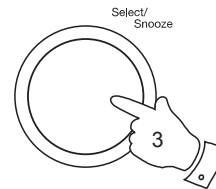

Viewing your playlist

1. Press the **On/Off** button to switch on the unit. Press the **Mode** button as needed until the *Music Player* mode display is shown. The *Music Player* menu will then be shown on the display.
2. Rotate the **Tuning/Select** control until 'My Playlist' is highlighted on the display. Press the control to enter the playlist.
3. Rotate the **Tuning/Select** control to scroll through the playlist. Tracks which are served via UPnP will show their track name and USB tracks will show their file name.

Mode

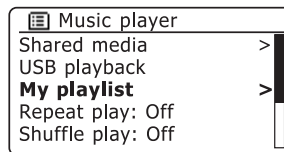

Select/
Snooze

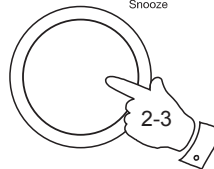

Erasing a track from the playlist

1. Press the **Menu** button to enter the main *Music Player* menu.
2. Rotate the **Tuning/Select** control until 'My Playlist' is highlighted on the display. Press the control to enter the playlist.
3. Rotate the **Tuning/Select** until the track you wish to erase is highlighted. **Press and hold** the **Tuning/Select** control.
4. You will be asked to confirm the deletion. To delete the track rotate the **Tuning/Select** control until 'YES' is highlighted on the display. Press the control to cause the track to be deleted.
5. If you do not wish to delete the track from the list rotate the **Tuning/Select** control to highlight 'NO' and press the control to cancel the operation.

Menu



Select/
Snooze

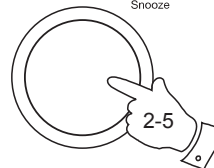

Clearing the playlist

1. Press the **Menu** button to enter the main *Music Player* menu.
2. To clear the whole playlist rotate the **Tuning/Select** control until '*Clear My playlist*' is highlighted on the display. Press the control.
3. To clear the whole playlist rotate the **Tuning/Select** control until '*YES*' is highlighted on the display. Press the control to cause the playlist to be cleared.
4. If you do not wish to clear the playlist rotate the **Tuning/Select** control to highlight '*NO*' and press the control to confirm.

Menu



Select/
Snooze

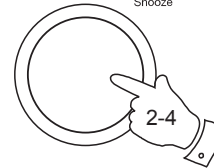

Playing your playlists

1. Press the **Menu** button to enter the main *Music Player* menu.
2. Rotate the **Tuning/Select** control until '*My playlist*' is highlighted on the display. Press the control.
3. To play the playlist from a particular track, rotate the **Tuning/Select** control until the desired track is highlighted then press the control to start play.
4. While playing from the playlist, you can use this function to jump to a particular track within the playlist.
5. While playing from the playlist, you may add additional tracks or albums or remove specific tracks (please see the preceding pages).

Menu



Select/
Snooze

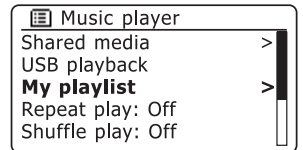
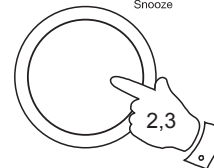

Prune servers

Your radio stores details of UPnP servers that it has seen via its network connection in its internal memory. If you use the radio at different locations you may find that there are servers listed by the radio that you are no longer interested in. The prune servers functions allows the list to be reinitialised so that only active UPnP servers on the currently connected network are shown when selecting 'Shared Media' from the Music Player menu.

1. Press the **Menu** button to enter the main *Music Player* menu.
2. Rotate the **Tuning/Select** control until '*Prune servers*' is highlighted on the display. Press the control.
3. To remove servers that are no longer required rotate the **Tuning/Select** control until '*YES*' is highlighted on the display. Press the control to cause the servers to be removed.
4. If you do not wish to prune servers rotate the **Tuning/Select** control to highlight '*NO*' and press the control to confirm.

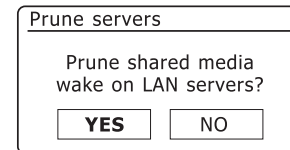
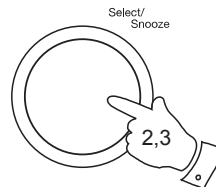
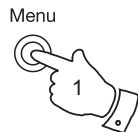

Wake On LAN

If you are using a computer as a UPnP server for playing your music files via your radio, you may not wish to keep that computer operating when you are not listening via your radio. If your computer is suitably configured, it can either shut down, or enter a stand-by or hibernation state when it is not being used.

Your radio can wake up a computer which has shut down using a Wake On LAN command via the network provided that the radio has previously connected to a UPnP server application on that computer. A computer which is not currently active will be shown with a question mark in the list of UPnP servers.

Many computers will not respond to Wake On LAN commands from the radio in all modes, and may require software, device driver, BIOS, hardware or router configuration changes for this function to operate. Failure of a computer to respond to Wake On LAN is not considered a fault of the radio.

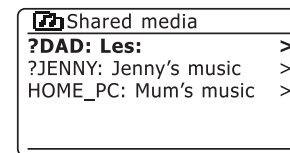

By default, your radio will shut down its WiFi or Ethernet connection when it is in standby. This minimises power consumption but it does mean that you will need to switch the radio on manually in order to use either the 'Play to' function or any other remote control software.

If you need to be able to remotely control the radio even when it has been put into standby, then you can choose to keep the network connected by using the 'Keep connected' option in the network settings menu. In the standby mode display either the WiFi signal indicator is shown with or without a cross through it, or the Ethernet connection is shown unplugged or plugged in according to the chosen network settings.

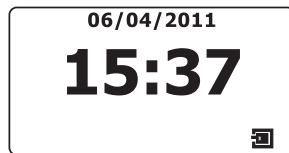
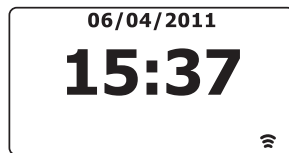
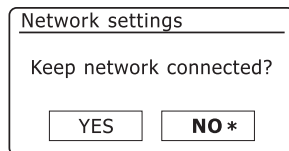
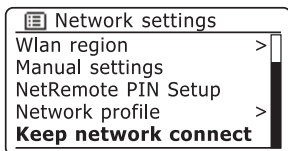

Windows 7 'Play to' function (UPnP renderer)

If you use Windows 7, it is possible to choose a music album, track or playlist at the computer and then tell Windows that this should be played on the radio using the 'Play to' function.

Using suitable software (sometimes known as a UPnP Control Point), similar functionality is available for other computer types and for handheld devices using Apple's iOS or Android operating systems. In this mode the radio acts as a UPnP Renderer.

1. In order to use the 'Play to' function, the radio must be actively connected to the network. The first time that you use the 'Play to' function you will need to allow Windows to recognise your radio. To do this, please go to step 2.
If you have previously used 'Play to' so that Windows remembers your radio and you have configured your radio to keep its network connection in standby mode (see 'Keep network connected', at left), then go to step 3.
2. If your radio is not currently running, or does not have an active connection to your network, then you should first switch on your radio and select the Music player mode using the **Mode** button. Then select 'Shared media' from the menu so that the radio establishes a connection with Windows Media Player on your PC. After this step, all other functions may be performed from your computer.
3. At your Windows 7 PC, locate the file, album or playlist that you wish to play on the radio.
4. Use the right-hand mouse button to pop-up a menu of options for the chosen item and select the 'Play to' option.
5. Windows should show you one or more devices, including your radio, to which you may choose to send the music. Highlight the radio item and click with the left mouse button.

6. Windows will then open a 'Play to' window showing the track or tracks to be played. Your computer will then take control of your radio. Your radio will enter the Digital Media Renderer mode (DMR) and after a few seconds the radio will start playing. The display on the radio will show that it is in DMR mode.
7. While the radio is playing in DMR mode you can use the controls in the 'Play to' window on your computer to skip tracks, fast-forward or rewind, to pause or restart, and to change the volume on the radio.
You may also use the controls on your radio to adjust volume, display track information (press the **Info** button) or to change operating mode. It is not possible to skip tracks or pause playback using the radio's controls while it is in DMR mode.
8. While playing, you may select additional content within Windows and again use the 'Play to' function (see steps 3 – 5). The additional tracks will be added to the playlist in the current 'Play to' window. You may also delete or change the order of tracks within the 'Play to' window.
9. When you wish to exit DMR mode, simply either switch off your radio or press the mode button to select a different operating mode.

Don't forget that in order to reselect the DMR mode and to be able to use 'Play to' from Windows you must first ensure that your radio has an active connection to your network (see steps 1 and 2 above).

Note: Some Windows security software can prevent correct operation of the 'Play to' function. Such software may have updates or configuration options which will permit 'Play to' to operate correctly - please consult your anti-virus software supplier. The 'Play to' function in Windows 7 has been tested successfully with the Stream 205 radio when using Microsoft's Security Essentials software without problems.

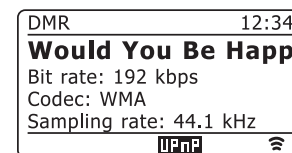
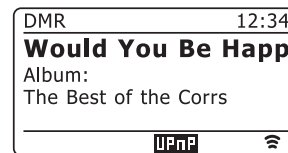
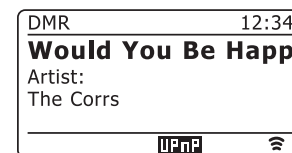
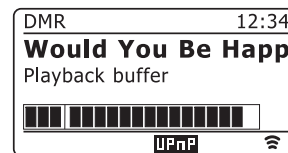
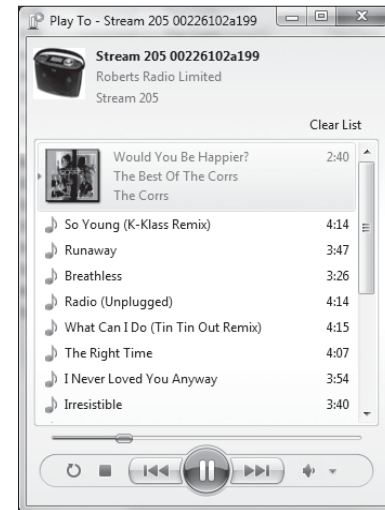

Last.fm - the basics

Last.fm is an Internet-based on-line music service with millions of tracks available which you can access using your radio, your computer and other devices. It plays personalised interactive radio stations based on your choice of artists and songs, your listening history, and similar tracks based on the preferences of other Last.fm listeners with similar music tastes. This can introduce you to a new range of artists and tracks which you will probably enjoy but which you may never have heard before.

Before you can use Last.fm with your radio, you will need to have created an account at the Last.fm web site. You can then start to listen to radio stations initially based on particular artists or tags/genres.

Last.fm is available on various platforms and computer media players. Any personalisations that you make to your account from one platform are reflected on the others.

Last.fm has a strong emphasis on interaction with other listeners, sharing your favourite music and exploring other users' playlists and stations, both directly, and through social networking sites. There are also privacy options that you can apply to your account using the Last.fm web site.

Scrobbling and Love / Ban features

Scrobbling is the method that Last.fm uses to learn about your listening habits. Your radio can 'scrobble' the tracks that you listened to using the UPnP Music Player and Last.fm modes. This sends track names to Last.fm, adding them to your Last.fm library, and helps the service to tailor its future recommendations to your musical tastes. Using two dedicated buttons on the radio, you can tell Last.fm that you love particular tracks, or you can ban a track from ever being played again. This also influences the tracks you are offered in the future.

User accounts

In order to use the Last.fm service with your radio, you must either create a Last.fm account or already have one set up. This account keeps track of your musical preferences and listening choices and is what makes the music offered by Last.fm personal to you. Setting up an account is simple and is done via the Last.fm web site. You then enter the account details into your radio (see the following pages).

The radio allows more than one set of Last.fm account details to be entered. If the unit is used by more than one person, it is possible to choose which account is used when listening to Last.fm and for scrobbling from the Music Player.

The features of the Last.fm service are only available on the radio with a subscription to Last.fm. This may differ from the range of features available when accessing the Last.fm service from a computer or any other device. The provision of the Last.fm service and the features offered with and without subscription are subject to terms and conditions set out on the Last.fm web site.

Your Roberts Stream 205 radio offers you a subscription level account with Last.fm for a limited trial period. You may optionally extend this using the subscription facility via the Last.fm web site at www.last.fm.

Last.fm may choose to modify the user selection and features from time to time.

Setup a Last.fm user account

Before you can use the Last.fm feature, you should sign-up and create an account on the web site <http://www.last.fm> using the internet browser on your computer. Be sure to make a note of the user name and password.

1. Press the **On/Off** button to switch on your radio. Press the **Mode** button as needed until the *Last.fm* mode display is shown.
2. Press the **Menu** button to enter the main *Last.fm* menu.
3. Rotate the **Tuning/Select** control until '*Last.fm setup*' is highlighted on the display. Press the control to enter the setup menu.
4. Rotate the **Tuning/Select** control until '*User Accounts*' is highlighted. Press the control and then select '<Add new account>'.
Press the control and then select '<Add new account>'.

5. The radio will then require you to enter the user name for your Last.fm account. This must be identical to account name used on the Last.fm web site. *Note - the user name is sensitive to the use of upper and lower case letters and symbols.*

The three controls on the right-hand side of the screen have special functions. You can quickly access these by pressing the **Info** button and then use the **Tuning/Select** control as needed (see also 'Text Entry' on page 9).

select '**BRSP**' to erase a character just entered (long press to clear); **Info** again to continue

select '**OK**' when the complete user name has been entered

select '**CANCEL**' to cancel and go back to the previous menu

Once the user name is entered you will need to enter password.

6. Enter the password using the **Tuning/Select** control using exactly the same method.

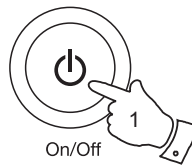

Mode



Menu



Select/
Shooze

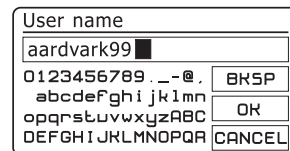
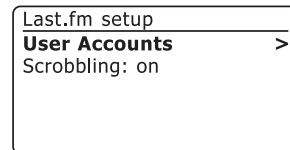
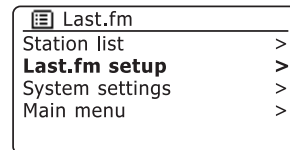
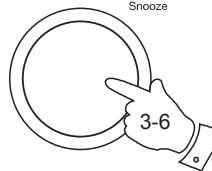

Setup a Last.fm user account - cont.

- The account information entered will be saved and then the validity of the account will be checked with Last.fm. If the account is invalid, the display will show '*Unauthorised*'. If needed, press the **Tuning/Select** control to modify the information.
- Once the account is setup, the display will show the Last.fm station menu list.

Note that it is possible to have up to four accounts set up in the radio for multiple users. Each user's listening preferences can be managed separately via the Last.fm web site.

Selecting an account

If you have more than one Last.fm account set up in your radio, you may easily switch between them.

- Use the **Mode** and **Menu** buttons to enter the *Last.fm* main menu.
- Use the **Tuning/Select** control to enter the '*Last.fm setup*' menu followed by the '**User Accounts**' menu. The display will show those accounts whose details are stored in the radio. The account which is currently in use will be marked with an asterisk.
- Use the **Tuning/Select** control to highlight the account that you wish to switch to. Then briefly press the control to immediately select the alternative account.
- The display will then show the Last.fm station list. Choosing an option will then play tracks according to the selected account's preferences.

Mode



Menu



Select/
Snooze

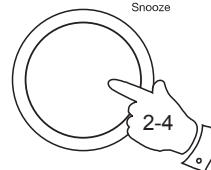

Password	
1234-aBcD	
0123456789 . _ - @ .	BACKSP
abcdefghijklmnop	OK
opqrstuvwxyzABC	CANCEL
DEFGHIJKLMNQPQR	

Last.fm
Create Artist Radio
Create Tag Radio
Your library
Your Recommendations
Your Neighbourhood

Last.fm
Station list >
Last.fm setup >
System settings >
Main menu >

Last.fm setup
User Accounts >
Scrobbling: on

User Accounts
aardvark99
Gerry-T
Julia-S
Les-M *

Listening to Last.fm

Last.fm can present music tracks according to several criteria. You may choose from the following options:

'Create Artist Radio' - Plays a selection of tracks by a specified artist and other similar artists. You choose an artist by entering their name or part of their name and then choose from the search results.

'Create Tag Radio' - Plays a selection of tracks tagged with certain keywords. You pick a tag word or genre by entering a word or phrase and then choose from the search results.

Note that it is advisable to be as exact as possible when entering tags or genres. For example, enter BOLLYWOOD rather than BOLLY. Tags are user-generated and fed to Last.fm via the scrobbling process, so there can sometimes be spurious tags connected to only a few tracks, which may give an Insufficient Content error when searching.

'Your Library' - Plays all tracks scrobbled to your profile, or tracks by artists you've added to your library. This information can be edited on the Last.fm web site.

'Your Recommendations' - Plays tracks recommended to you based on your music profile and that of other listeners with similar tastes.

'Your Neighbourhood' - Plays tracks from the libraries of people on Last.fm with similar music taste to yours.

'Your Recent Stations' - This option lists your most recent Last.fm selections.

'History' - This option lists the last tracks you have listened to, most recent tracks first. *Note that this is a display-only option - you cannot select a track from the list and listen to it again on demand.*

Note: The listening selections may be changed in the future by Last.fm. The Last.fm stations list is controlled by Last.fm and is subject to their terms and conditions.

Listening to Last.fm - cont.

1. Press the **Mode** button as needed to select *Last.fm* mode.
2. Press the **Menu** button to enter the main *Last.fm* menu. Rotate the **Tuning/Select** control until 'Station list' is highlighted on the display. Press the **Tuning/Select** control.
3. Rotate the **Tuning/Select** control until the desired Last.fm playing option is highlighted on the display (see the preceding page for details of the options). Press the **Tuning/Select** control to select.
4. If one of the playing options was selected, the display will show 'Connecting...' and the radio will begin playing. For Artist or Tag options, please see the next page.

Mode



Menu

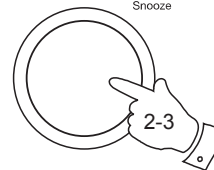

5. If you wish to skip the current track, press the **Fast-forward** button to start playback of another track from your selection.

Select/
Snooze

You can use the Love and Ban buttons to tell Last.fm which tracks you particularly like, or which tracks you wish to ban from your library.

6. If you like the track currently playing and wish it to influence the content that Last.fm offers to your account, press the **Love** button. The radio will show 'Loved this track' and will continue playback.
7. During playback, if you do not like a particular track and wish not to hear it again, press the **Ban** button. The radio will show 'Banned this track' and will offer another track.

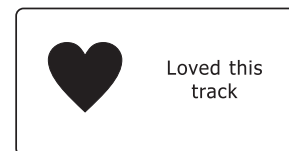
Love  Ban

If you accidentally love or ban a track, you can remove it from your list of loved or banned tracks using the Last.fm web site.

Search by Artist or Tag

1. Press the **Mode** button as needed to select *Last.fm* mode.
2. Press the **Menu** button to enter the main *Last.fm* menu. Rotate the **Tuning/Select** control until 'Station list' is highlighted on the display and then press the control to select.
3. Rotate the **Tuning/Select** control until 'Create Artist Radio' or 'Create Tag Radio' is highlighted and then press the control to select.

4. Use the **Tuning/Select** control to enter the Artist name or Tag by entering the name or part of the name. For example, entering 'PINK' would list artists including 'Frijid Pink', 'Pink' and 'Pink Floyd'. Entering 'BLUES' for a tag will find 'blues', 'blues rock' and many others.

Searching uses only the characters 0-9, A-Z and Space.

The three controls on the right-hand side of the screen have special functions. You can quickly access these by pressing the **Info** button and then use the **Tuning/Select** control as needed:

select '**BACKSP**' to erase a character just entered (long press to clear); **Info** again to continue

select '**OK**' when you are ready to search

select '**CANCEL**' to cancel and go back to the previous menu

Once the artist or tag is entered highlight '**OK**' and press the **Tuning/Select** control to search. See also 'Text Entry' on page 9.

5. Rotate and then press the **Tuning/Select** control to choose one of the tags or artists offered. The display will show 'Connecting...' and the radio will begin playing content guided by the search.

6. If you wish to skip the current track, press the **Fast-forward** button to start playback of another track based on your selection.

You can use the **Love** and **Ban** buttons (see the preceding page) to tell Last.fm which tracks you particularly like or which tracks you wish to ban from your library.

Mode



Menu



Select/
Snooze

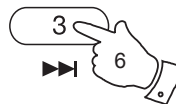
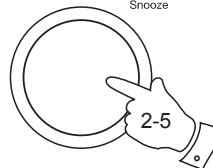

Love



Ban

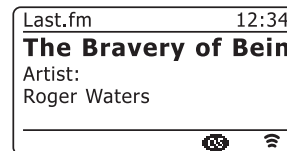
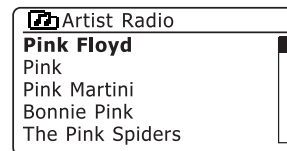
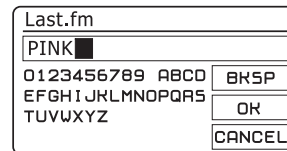
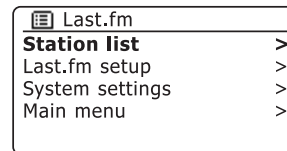

Display modes

Your radio has a range of display options when in Last.fm mode. Note that the information may not always be 100% accurate since some of the Last.fm data is based upon information scrobbled from user's files.

1. Press the **Info** button to cycle through the different options.

- | | | |
|----|-----------------|---|
| a. | Artist | Displays the name of the artist for the currently playing track |
| b. | Album | Displays the name of the album from which the current track is taken. |
| c. | Progress bar | Displays the playback progress for the track currently playing. |
| d. | Radio Name | Displays the name of the currently playing Last.fm 'radio station' |
| e. | Account | Displays of the Last.fm account currently in use. |
| f. | Format | Displays the bit rate and format of the track currently playing. |
| g. | Playback buffer | Displays the radios internal buffer level. |
| h. | Date | Displays the current date. |

Info

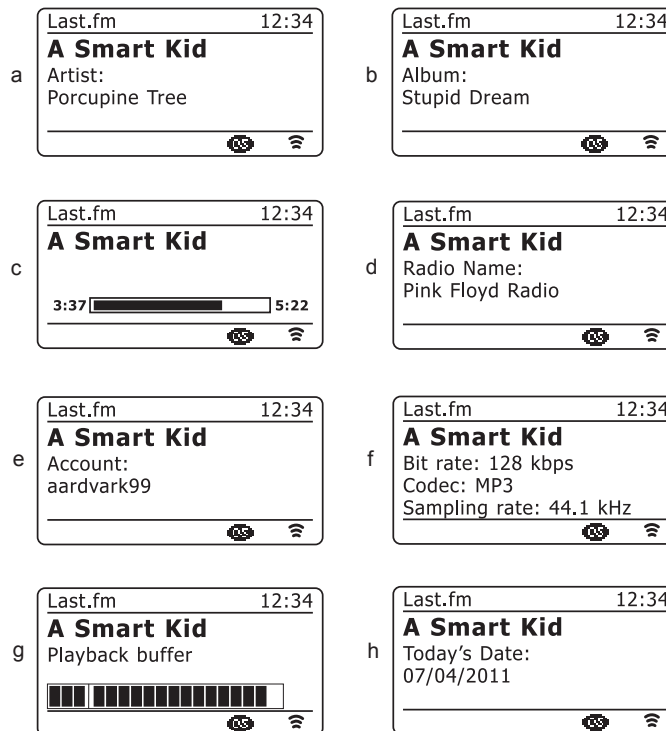

Whenever the radio is displaying an information screen, the time is displayed in the top-right corner of the display, and a WiFi strength or Ethernet connection indicator is shown in the bottom-right corner.

Your Recent Stations / History

The Last.fm stations menu offers two options which relate to your personal Last.fm listening history. 'Your Recent Stations' allows easy access to your recent Last.fm selections whether made using your radio or accessed on other platforms such as your PC. You can then directly choose one of those selections without entering its details again.

The 'History' option on the Last.fm stations menu allows you to see the most recently played tracks, with the most recent displayed first. *Note that this is only a display - it is not possible play tracks from this list.*

1. Press the **Mode** button as needed to select *Last.fm* mode.
2. Press the **Menu** button to enter the main *Last.fm* menu. Rotate the **Tuning/Select** control until 'Station list' is highlighted on the display. Press the **Tuning/Select** control.
3. Rotate the **Tuning/Select** control until 'Your Recent Stations' or 'History' is highlighted on the display. Press the **Tuning/Select** control to select as needed.
4. The Recent Stations menu lists your most recent Last.fm selections. Simply rotate and press the **Tuning/Select** control to choose which selection should be played. At the time of writing, the 25 most recent selections are offered.
5. The history display will show a list of the six tracks most recently played from Last.fm with the most recent first. Use the **Tuning/Select** control to highlight any track of interest. The highlighted track will scroll across the display and will include track name, artist and album information.
- The display will revert to the currently selected Last.fm display mode after 15 seconds. Alternatively press the **Back** button to exit.

Note: The history display will not be available if you choose to hide real-time listening information in the privacy settings of your user profile on the Last.fm web site.

Mode



Menu



Select/
Snooze

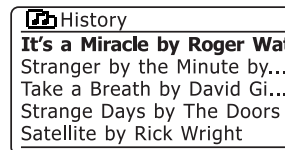
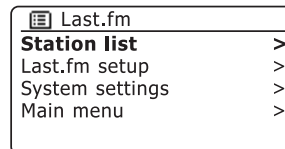
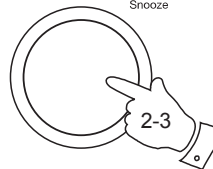

Deleting details of a Last.fm account

You may wish to delete a Last.fm account from your radio (for example, if a friend's details had been entered when they were visiting).

1. Use the **Mode** and **Menu** buttons to enter the *Last.fm* main menu.
2. Use the **Tuning/Select** control to enter the '*Last.fm setup*' menu followed by the '*User Accounts*' menu. The display will show those accounts whose details are stored in the radio.
3. Use the **Tuning/Select** control to highlight the account that you wish to remove from the radio. Then **press and hold** the **Select** control. The display will ask whether this account should be deleted.
4. Highlight 'YES' and then press the **Tuning/Select** control to delete the account details. The account will not be deleted from the Last.fm web site. Alternatively, select 'NO' in order to retain the account details.
5. Press the **Back** button twice to return to the *Last.fm* menu.

Scrobbling - On / Off control

1. To turn Music Player Scrobbling on or off for the currently selected account, access the Last.fm setup menu (steps 1-2 above).
2. Use the **Tuning/Select** control to highlight the '*Scrobbling:*' option. Press the control to switch between '*Scrobbling: on*' and '*Scrobbling: off*'.

Note: If other people use the radio, you may wish to switch scrobbling off so that their listening does not modify your account's listening preferences. Alternatively, you could switch the radio to another account (please see page 54).

Mode



Menu



Select/
Snooze

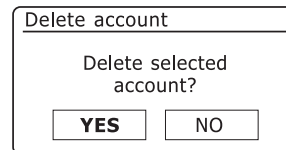
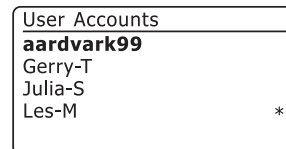
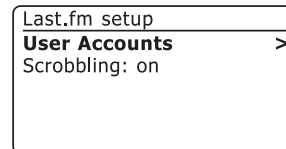
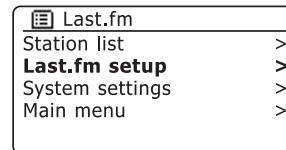
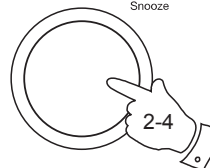

Select/
Snooze

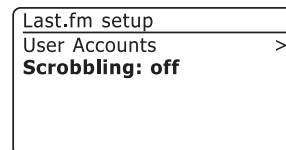
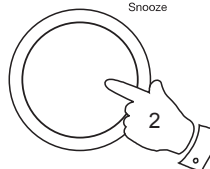

DAB Radio

Using DAB mode for the first time

1. Carefully extend the telescopic aerial.
2. Press the **On/Off** button to switch on the radio. If the radio has been used before the last used mode will be selected.
3. Press the **Mode** button as needed so that *DAB radio* mode is selected on the display.
4. If this is the first time that DAB mode is used a quick scan of the Band III DAB channels will be carried out. The display will show 'Scanning'. (If the radio has been used before the last used station will be selected instead.)

During the scanning process, as new stations are detected the station counter will increase and the stations will be added to the list which is stored in the radio. The bar graph indicates the progress of the scan.

5. When scanning is completed the radio will list the stations found (in numeric-alpha order 0...9...A...Z), unless it has previously been tuned to a DAB station.

Rotate the **Tuning/Select** control to scroll through the list of available DAB radio stations.

Press the **Tuning/Select** control to select the highlighted station. The display may show 'Connecting...' while the radio re-tunes.

Use the **Volume** buttons to set the sound level as needed.

6. If the station list is still empty after the scan the display will show 'Service not available'. If no stations are found it may be necessary to relocate your radio to a position giving better reception.

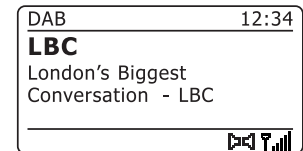
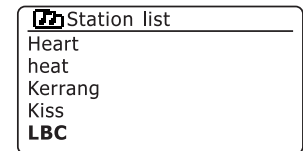
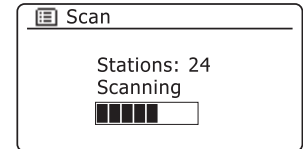
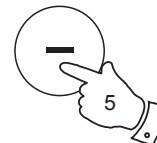
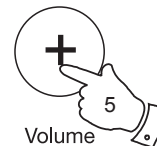
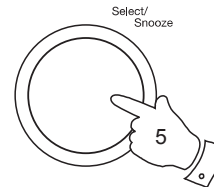
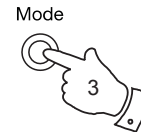
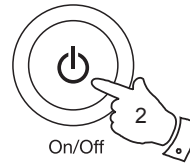

Selecting a DAB radio station

1. When playing a DAB radio station, the display normally shows the name of the current station with other related information.
2. Rotate the **Tuning/Select** control to access the radio station list and to scroll through the available stations.
3. Press the **Tuning/Select** control to select the highlighted station. The display may show 'Connecting...' while the radio re-tunes.
4. Use the **Volume** buttons to set the sound level as needed.

Note: If the display shows 'Station Not Available' it may be necessary to relocate your radio to a position giving better reception.

A question-mark in front of the station name indicates that the station has not recently been detected by the radio. It may still be available.

The use of the radio station presets is described on page 75.

Secondary services

Some DAB radio stations can have one or more secondary stations associated with them. Typically these are not broadcast continually. If a station has a secondary station available then the secondary will appear in the list of station names beneath the main (or primary) station. Examples are the programmes 'Daily Service' and 'Parliament' on BBC Radio 4.

1. To listen to a secondary service, use the **Tuning/Select** control to scroll to the chosen station, and press the control to tune to the station.

If the secondary service is not available (off-air) then the primary service will be selected.

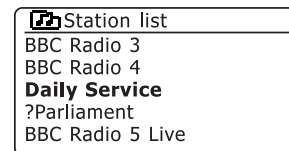
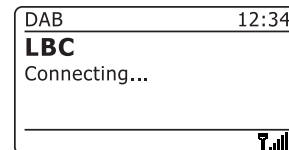
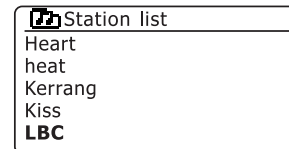
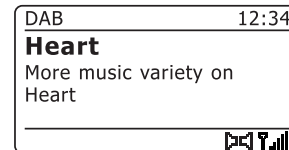
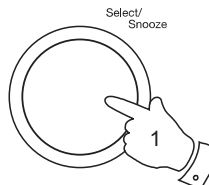
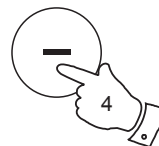
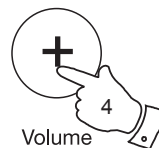
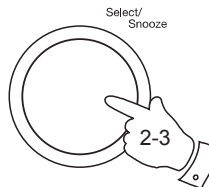

Display modes

Your radio has a range of display options when in DAB mode:-

1. Press the **Info** button to cycle through the different options.



- a. Text Displays text messages such as the artist or track name, phone in number, traffic alerts, etc.

- b. Program Type Displays the type of station being listened to such as Pop, Classic, News etc.

- c. Multiplex Name / Frequency Displays the name of the DAB multiplex to which the current station belongs as well as its broadcast frequency.

- d. Signal error / strength Displays the signal error and strength for the station being listened to. A lower error number indicates a better quality of radio signal. The signal strength graph can be used when positioning the radio or its antenna. For good reception the graph should occupy three or more blocks.

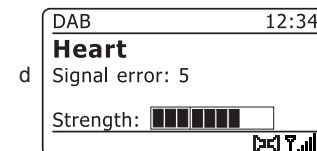
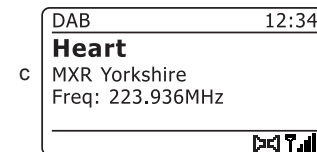
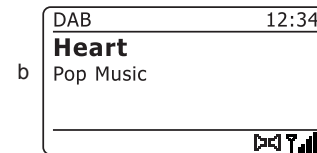
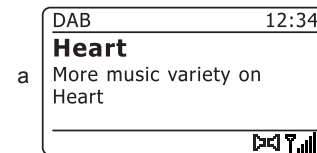

Display modes - cont.

- e. Bit rate and audio type Displays the digital bit rate and audio coding information for the station being listened to.
- f. Date Displays the current date.

A signal strength indicator is always shown in the lower area of the display on the right hand side.

If the broadcast being received is in stereo, then the stereo speaker symbol will be shown.

If the currently tuned station has been stored as a preset, then the preset number will also be shown (see page 75).

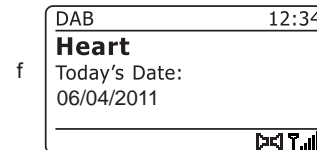
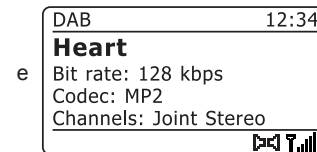

Finding new DAB radio stations

Should you wish to use your radio for DAB reception in a new location, or if no stations were detected during the initial scan, you can follow this procedure to allow your radio to find out which DAB radio stations are available.

1. Ensure that the telescopic antenna is extended, and then press the **Mode** button as needed to select *DAB radio* mode.
2. Once in DAB mode press the **Menu** button.
3. Rotate the **Tuning/Select** control until 'Scan' is highlighted on the display.
4. Press the **Tuning/Select** control to initiate the scan. The display will show 'Scanning' and your radio will perform a scan of the Band III DAB channels. As new stations are found the station counter will increase and stations will be added to the list. The bar graph indicates the progress of the scan.

Mode



Menu



Select/
Snooze

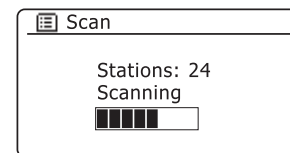
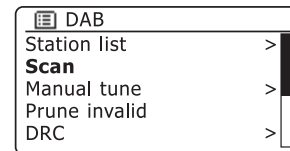
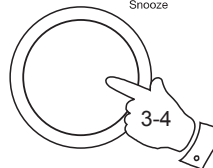

Manual Tuning

Manual tuning allows you to tune directly to the various Band III DAB channels (5A to 13F). At the time of writing, all UK DAB stations are located in the range of channels 11B to 12D.

1. When in DAB mode press **Menu** button so that the display shows the *DAB* menu.
2. Rotate the **Tuning/Select** control until '*Manual tune*' is highlighted.
3. Press the **Tuning/Select** control to enter manual tune mode.
4. Rotate the **Tuning/Select** control to choose the required DAB channel.
5. Press the **Tuning/Select** control to cause the radio to tune to the chosen channel.

When the radio has tuned, the display shows the channel number and frequency, and the name of the DAB multiplex found (if any).

A bar graph shows the signal strength and is useful if you need to reposition the radio or its aerial. The minimum signal marker 'I' which separates the left and right parts of the signal graph shows the minimum signal level required for satisfactory reception.

Any new radio stations found on the tuned DAB multiplex will be added to the list stored in the radio.

6. Press the **Menu** or **Back** button twice to revert to the main DAB menu.

Menu

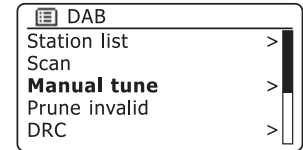

Select/
Snooze

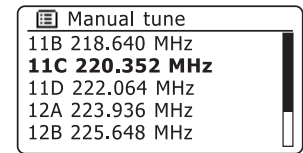
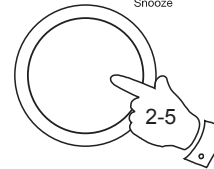

Menu

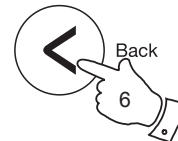
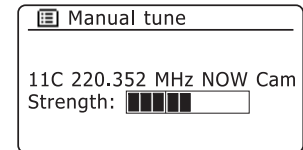

Dynamic Range Control settings

Dynamic Range Control (also known as DRC) can make quieter sounds easier to hear when your radio is used in a noisy environment by reducing the dynamic range of the audio signal.

1. Press the **On/Off** button to switch on your radio.
2. Press the **Mode** button as needed to select *DAB radio* mode.
3. Press the **Menu** button to enter the *DAB* menu.
4. Rotate the **Tuning/Select** control until '*DRC*' is highlighted on the display.
5. Press the **Tuning/Select** control to enter the DRC adjustment mode. The current DRC setting will be indicated with an asterisk.
6. Rotate the **Tuning/Select** control to highlight the required DRC setting (the default is Off).
'*DRC Off*' - DRC is switched off, Broadcast DRC will be ignored.
'*DRC high*' - DRC is set as sent by broadcaster.
'*DRC low*' - DRC level is set to 1/2 that sent by broadcaster.
7. Press and release the **Tuning/Select** button to confirm the setting.

Note: Not all DAB broadcasts use the DRC function. If the broadcast does not provide DRC information, then the DRC setting in the radio will have no effect.

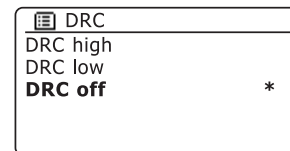
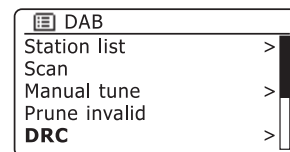
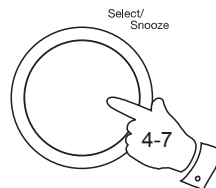
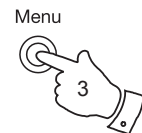
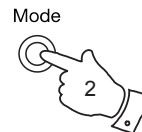
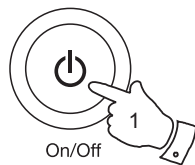

Station order setup

Your radio has 3 station order settings from which you can choose. The station order settings are, alphanumeric, ensemble and valid.

Note: The default station order on your radio is alphanumeric.

1. Press the **On/Off** button to switch on your radio.
2. Press the **Mode** button as needed to select *DAB radio* mode.
3. Press the **Menu** button to enter the DAB menu list.
4. Rotate the **Tuning/Select** control until 'Station order' is highlighted. Press the **Tuning/Select** control to enter the station order adjustment mode.
5. Rotate the **Tuning/Select** control to choose between 'Alphanumeric', 'Ensemble' and 'Valid'.
'Alphanumeric' - sorts the station list alpha-numerically 0...9 A...Z.
'Ensemble' - organises the station list by DAB multiplex.
'Valid' - shows those stations for which a signal can be found ahead of those that the radio has marked as possibly unavailable.
 The current setting is indicated by an asterisk.
6. Press the **Tuning/Select** control to select the required station order.
7. Press the **Menu** button as needed to return to the DAB menu or to the stations list.

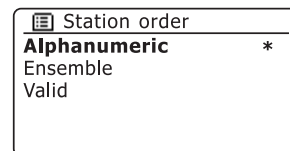
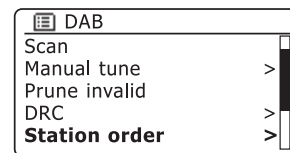
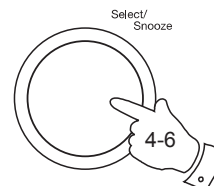
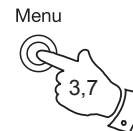
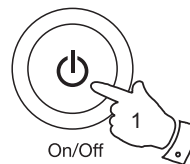

Prune stations

If you move to a different part of the country, some of the stations which were listed may no longer be available. Also, from time to time, some DAB services may stop broadcasting, or may change location or frequency. Stations which cannot be found, or which have not been received for a very long time are shown in the station list with a question mark.

The Prune stations function will delete the marked DAB stations from your station list.

1. Press the **On/Off** button to switch on your radio.
2. Press the **Mode** button as needed to select *DAB radio* mode.
3. Press the **Menu** button to enter the *DAB* menu.
4. Rotate the **Tuning/Select** control until '*Prune invalid*' is highlighted. Press the **Tuning/Select** control.
5. To cause the stations list to be pruned, eliminating unavailable stations rotate the **Tuning/Select** control until '*YES*' is highlighted on the display.
6. Press the **Tuning/Select** control to cause the invalid station names to be removed from the station list.

If you do not wish to prune stations, highlight '*NO*' and then press the control. The display will revert to the previous menu.

Note: If you have moved your radio to a different part of the country you should also carry out a search for new stations (please see the section 'Finding new stations' on page 65).

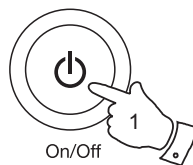

Mode



Menu



Select/
Snooze

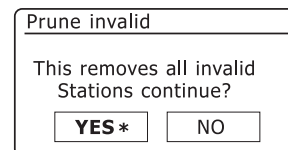
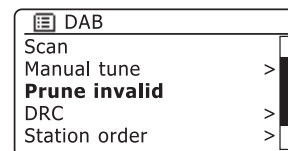
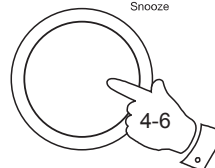

Operating your radio in FM mode

1. Carefully extend the telescopic aerial and press the **On/Off** button to switch on your radio.
2. Press the **Mode** button as needed to select *FM radio* mode.
3. Rotate the **Tuning/Select** control in a clockwise direction. The displayed frequency will increase. Press the **Tuning/Select** control to carry out an auto-tune. Your radio will scan up the FM band from the currently displayed frequency and will stop scanning when it finds a station of sufficient strength.
4. The display will show the frequency of the signal which has been found. If RDS information is available, after a few seconds the display will show the radio station name.
If you only hear hiss or interference, simply press the **Tuning/Select** control to scan further. Your radio may have found a spurious interference signal.
5. To find more FM stations press the **Tuning/Select** control to repeat the scan operation. To scan down in frequency, rotate the **Tuning/Select** control in a anti-clockwise direction first and then press the control. Your radio will scan down the FM band from the currently displayed frequency and will stop scanning when it finds a signal of sufficient strength.
6. When the end of the waveband is reached your radio will recommence tuning from the opposite end of the waveband.
7. Use the **Volume** buttons to adjust the sound level as needed.

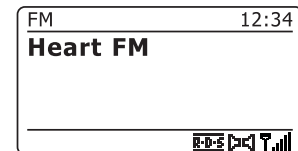
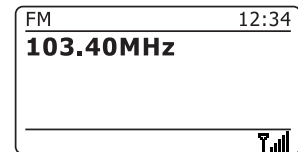
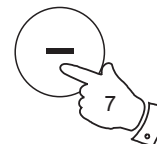
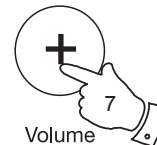
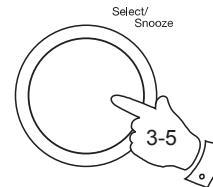
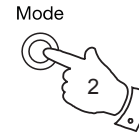
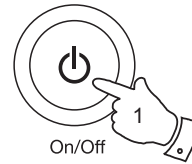

Manual tuning

1. Carefully extend the telescopic aerial and press the **On/Off** button to switch on your radio.
2. Press the **Mode** button as needed to select *FM radio* mode.
3. Rotate the **Tuning/Select** to control the frequency that the radio will tune to. The frequency will change in steps of 50kHz.
When the end of the waveband is reached the radio will recommence tuning from the opposite end of the waveband.
4. Use the **Volume** buttons to adjust the sound level as needed.

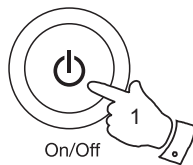

Mode



Select/
Snooze

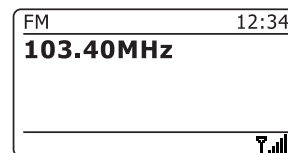
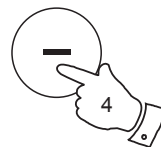
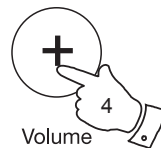
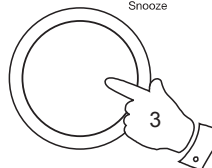

Display modes

Your radio has a range of display options when in FM mode:-

1. Press the **Info** button to cycle through the different options.

- a. Text Displays text messages such as the artist or track name, phone in number, traffic alerts, etc.
- b. Program Type Displays the type of station being listened to such as Pop, Classic, News etc.
- c. Frequency Displays the frequency of the FM signal.
- d. Date Displays the current date.

Note: If no RDS information is available, then the radio will only be able to display the frequency. There will be no text or programme type information available under these conditions.

The radio only provides displays when there is information available. So if there is no text, for example, that display is not available.

The RDS indicator at the bottom of the display shows that there is some RDS data present in the broadcast being received.

The stereo speaker display shows that the radio is receiving a stereo broadcast (please see also 'Stereo/Mono switching' on page 74).

Info



a



b

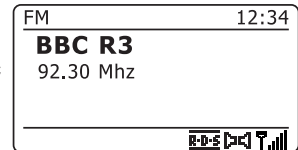

c



d

Scan setting

When using the FM mode your radio can be set to either scan only for strong signals (typically local stations and major national stations) or to scan all stations including distant radio stations.

1. Press the **Mode** button as needed to select *FM radio* mode.
2. Press the **Menu** button to enter the *FM* menu.
3. Rotate the **Tuning/Select** control until '*Scan setting*' is highlighted and then press the control to enter the scan adjustment mode.
The current scan setting is indicated with an asterisk.
4. To set your radio so that only the stations with the strongest signals are found during scanning rotate the **Tuning/Select** control until '*YES*' is highlighted. Press the **Tuning/Select** control to confirm the setting.
(Normally this will restrict scanning to local transmissions.)

Alternatively, to set your radio so that all available stations are found during scanning (local and distant transmissions) rotate the **Tuning/Select** control until '*NO*' is highlighted. Press the **Tuning/Select** control to confirm the setting.

5. Press the **Menu** button to return to the normal FM mode display.

Mode



Menu

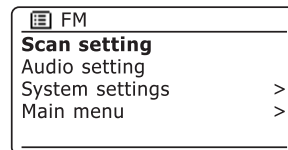

Select/
Snooze

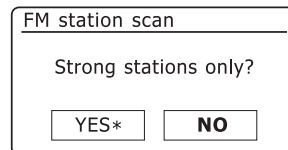
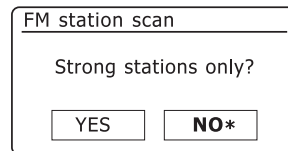
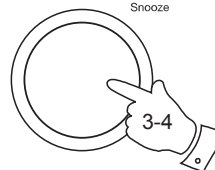

Stereo / Mono switching

If the FM radio station being listened to has a weak signal, some hiss may be audible. It is possible to reduce this hiss by forcing the radio to play the station in mono rather than stereo.

1. Press the **Mode** button as needed to select the *FM radio* mode display and tune to the required FM station as previously described.
2. Press the **Menu** button to enter the *FM* menu.
3. Rotate the **Tuning/Select** control until '*Audio setting*' is highlighted on the display. Press the **Tuning/Select** control to enter the audio setting mode.
The current setting is indicated with an asterisk.

4. To switch to mono in order to reduce the hiss from a weak FM signal rotate the **Tuning/Select** control until '*YES*' is highlighted. Press the **Tuning/Select** control to confirm the setting.

Alternatively, to return to the normal automatic 'stereo or mono' mode rotate the **Tuning/Select** control until '*NO*' is highlighted. Press the **Tuning/Select** control to confirm the setting.

5. Press the **Menu** button to return to the normal FM mode display.

Mode



Menu

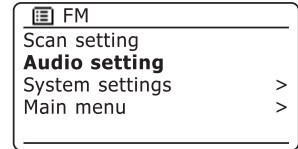

Select/
Snooze

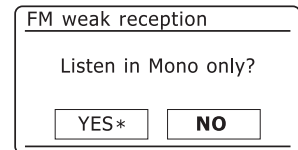
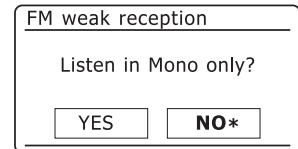
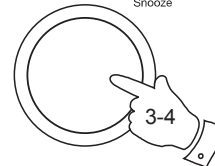

Presetting stations in DAB and FM modes

There are 5 memory presets each for DAB and FM radio. They are used in the same way for each operating mode.

1. Press the **On/Off** button to switch on your radio.
2. Tune to the required radio station as previously described.
3. To store the station as a preset, **press and hold** the required **Preset** button (1 - 5) until the display shows 'Preset stored'. The station will be stored under the chosen preset button. Repeat this procedure as needed for the remaining presets.
4. Stations which are already stored in the presets may be over written by following the above procedure.

Note: The radio station presets are retained in memory when the radio is switched off and disconnected from the mains supply.

Recalling a preset in DAB and FM modes

1. Press the **On/Off** button to switch on your radio.
2. Select the required operating mode using the **Mode** button.
3. Momentarily press the required **Preset** button. Your radio will then tune to the station stored in the selected preset memory. The chosen preset number is also shown in the lower area of the radio display, e.g. 'P2'.

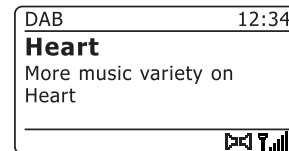
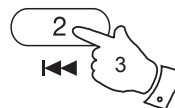
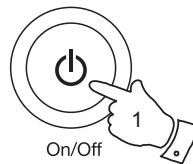

Mode

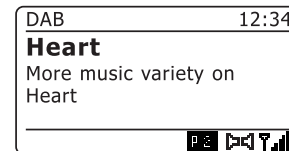
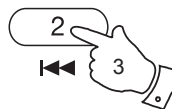

Automatically updating the clock

Your radio will normally update the clock automatically when connected to the internet. If you enter a time setting manually, the radio will calculate a local time offset which is then stored in memory. Whenever it synchronises the clock using the internet, including after a power failure, your radio will then set the clock automatically using this information.

You may wish to use the radio away from the internet, in which case you may specify that the unit sets its clock from DAB or FM radio broadcasts. After a power failure the radio will then set its clock the next time that you switch on the radio in DAB or FM mode.

Alternatively you may specify that the time is not automatically updated. In this case the clock must always be set manually after a power interruption.

1. With your radio switched on, press the **Menu** button to access the menu for the current mode.
2. Rotate the **Tuning/Select** control until 'System settings' is highlighted on the display. Press the control to enter the system settings menu.
3. Rotate the **Tuning/Select** control until 'Time/Date' is highlighted on the display. Press the control to enter the time setup.
4. Rotate the **Tuning/Select** control until 'Auto update' is highlighted on the display. Press the control to enter the auto-update menu.
5. Rotate the **Tuning/Select** control to choose an update option from 'Update from DAB', 'Update from FM', 'Update from Network' or 'No update' as required. Press the control to confirm your choice. The radio will then exit to the previous menu display.

Menu



Select/
Snooze

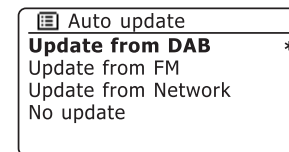
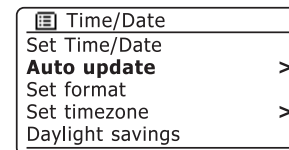
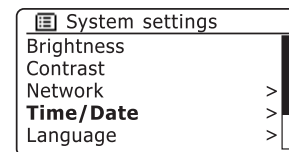
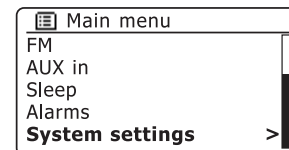
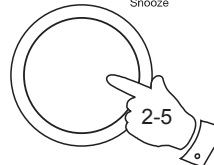

Setting the clock format

The clock display used in stand-by mode and on the playing mode screens can be set to 12 or 24 hour format. The selected format is then also used when setting the alarms.

1. With your radio switched on, press the **Menu** button to access the menu for the current mode.
2. Rotate the **Tuning/Select** control until 'System settings' is highlighted on the display. Press the control to enter the system settings menu.
3. Rotate the **Tuning/Select** control until 'Time/Date' is highlighted on the display. Press the control to enter the time setup.
4. Rotate the **Tuning/Select** control until 'Set format' is highlighted on the display. Press the control to enter the clock format menu.
The current clock display format is marked with an asterisk.
5. Rotate the **Tuning/Select** control to select either 12 or 24 hour format. Press the control to confirm your choice of clock format. The display will then revert to the previous menu.

If the 12 hour clock format is chosen, the radio will then use the 12 hour clock for the setting of alarms, and will display a 12 hour clock with an AM or PM indicator when in stand-by mode.

Menu

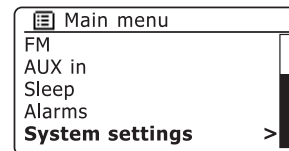

Select/
Snooze

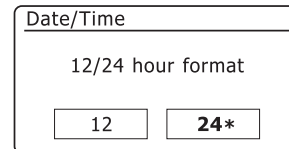
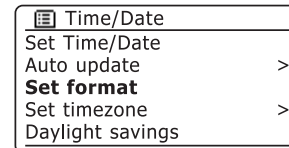
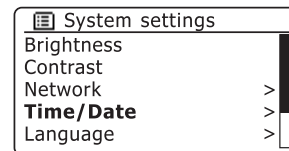
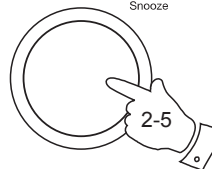

Manually setting the clock

The Stream 205 radio will normally set its clock automatically to UK time after a connection to the Internet has been established. Should you need to set the time manually, change the time zone, or manually switch from winter to summer time (GMT to BST - also known outside the UK as Daylight Savings Time), then please follow this procedure.

1. Press the **On/Off** button to switch on your radio.
2. Press the **Menu** button to access the menu for the current mode.
3. Rotate the **Tuning/Select** control until 'System settings' is highlighted on the display. Press the control to enter the system settings menu.
4. To change the time zone setting go to step 11.
To change from winter to summer time go to step 13.
To change the current time or date setting rotate the **Tuning/Select** control until 'Time/Date' is highlighted on the display, then press the control to enter the time and date setting screen.
5. Rotate the **Tuning/Select** control until 'Set Time/Date' is highlighted on the display. Press the control to enter the clock setup. The day digits will flash.
6. Rotate the **Tuning/Select** control until the correct day is shown on the display. Press the control to enter the selection. The month digits will then flash.
7. Rotate the **Tuning/Select** control to select the correct month. Press the control to enter the selection. The year digits will then flash.

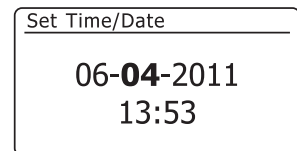
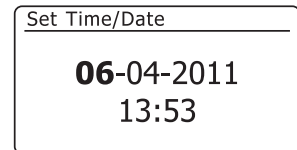
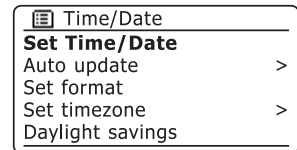
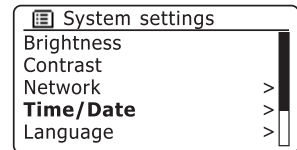
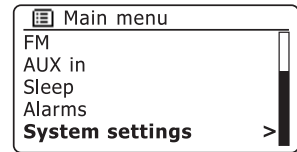
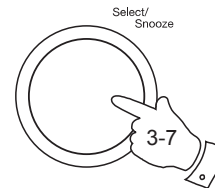
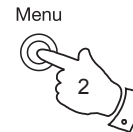
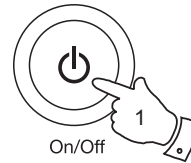

Manually setting the clock - cont.

8. Rotate the **Tuning/Select** control to select the correct year. Press the control to enter the selection. The hour digits will then flash.
9. Rotate the **Tuning/Select** control to select the correct hour. Press the control to enter the selection. The minute digits will then flash.
10. Rotate the **Tuning/Select** control to select the correct minutes. Press the control to enter the selection. The display will then return to the previous menu.
11. Rotate the **Tuning/Select** control until '*Set timezone*' is highlighted on the display then press the control.
12. Rotate the **Tuning/Select** control to highlight the time zone which is applicable to your location, then press the control to confirm the setting.
Press the **Menu** button to exit or go to step 13 to set the summer / winter time option.
13. Rotate the **Tuning/Select** control until '*Daylight savings*' is highlighted on the display then press the control. The asterisk shows the current setting.
In the UK, ON is equivalent to British Summer Time, OFF is equivalent to Greenwich Mean Time.
14. Rotate the **Tuning/Select** control to highlight '*ON*' or '*OFF*' as required then press the control to confirm the setting.
15. Press the **Menu** button to exit.

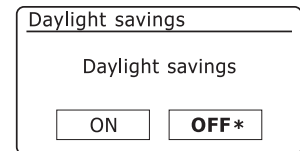
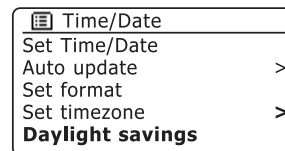
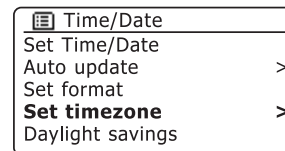
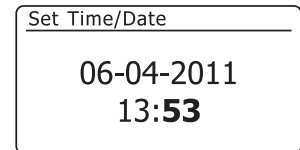
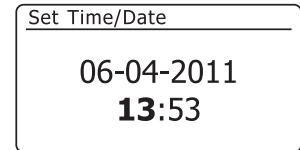
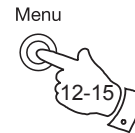
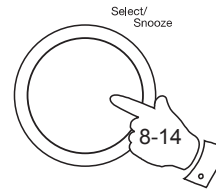

Setting the alarm clock

Your radio has two separate alarms which can be set to wake you to either the radio or a buzzer alarm. In the event of a power interruption your radio has built in memory that will retain your alarm settings.

Ensure that the time is set correctly before setting the alarms. Alarms cannot be used when the radio is running on batteries as the clock does not run in stand-by mode when only powered from batteries.

1. If your radio is in stand-by mode, press and hold the **Alarm** button (preset 1) to display the Alarms menu. Go to step 3.

If your radio is switched on, press the **Menu** button to access the menu for the current mode. Rotate the **Tuning/Select** control until 'Main menu' is highlighted on the display. Press the control to enter the main menu.

2. Rotate the **Tuning/Select** control until 'Alarms' is selected on the display. Press the control to see the current alarm settings. If no change is required, press the **Menu** or **Back** buttons to exit.

3. Rotate the **Tuning/Select** control until the desired alarm (1 or 2) is highlighted on the display. Press the control to enter alarm setup.

4. Rotate the **Tuning/Select** control until 'Time' is highlighted on the display. Press the control to adjust the alarm time.

5. Rotate the **Tuning/Select** control to choose the alarm hour. Press the control to confirm the setting.

6. Rotate the **Tuning/Select** control to choose the alarm minute. Press the control to confirm the setting. The display will then return to the alarm setting menu.

If the radio has been set to use a 12 hour clock format, there will also be an option here for setting AM or PM for the alarm time.

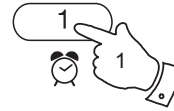

Menu



Select/
Snooze

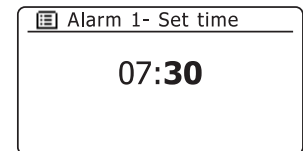
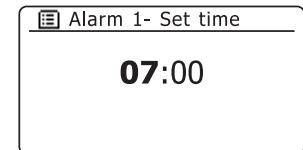
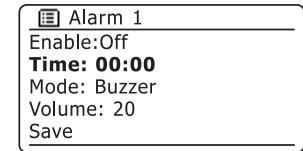
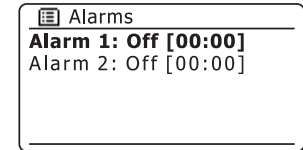
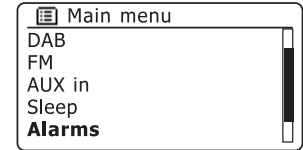
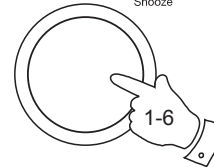

Setting the alarm clock - cont.

7. Rotate the **Tuning/Select** control to highlight '*Enable*' and press the control. The display will show the Frequency options for the alarm. The alarm frequency options are as follows:

'*Off*' - the alarm will be disabled

'*Daily*' - the alarm will sound everyday

'*Once*' - the alarm will sound once

'*Weekends*' - the alarm will sound only at weekends

'*Weekdays*' - the alarm will sound on weekdays only

Rotate the **Tuning/Select** control to choose the required alarm frequency option. Choosing Off will disable the alarm. Press the control to confirm the selection.

If you choose to set the alarm to Once you will also need to set the date using the **Tuning/Select** control.

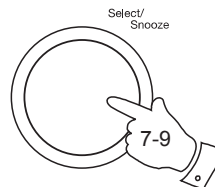

8. The alarm can be set to buzzer, Internet radio, DAB radio, FM radio or Last.fm. For whichever radio mode is selected, the radio alarm may be set to any of the stations which have been stored as presets or to the station most recently listened to.

Rotate the **Tuning/Select** control to highlight the current '*Mode*' option for the alarm, then press the control if you wish to change it.

Rotate the **Tuning/Select** control to highlight either '*Buzzer*' or the required radio mode. Press the control to confirm the selection.

9. If setting the alarm to a radio option, rotate the **Tuning/Select** control to highlight the '*Preset:*' option then press the control if you wish to change it.

Choose from either the radio station '*Last listened*' to, or from the presets 1 - 5. Scroll to the chosen option and press the control to confirm the selection. Note that you can only set the alarm to use a preset which has already been stored.

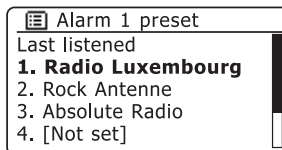
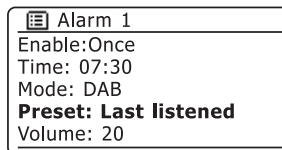
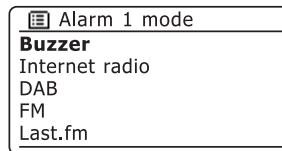
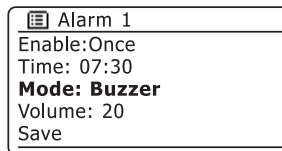
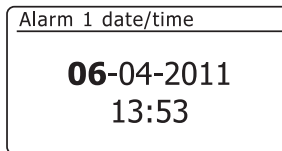
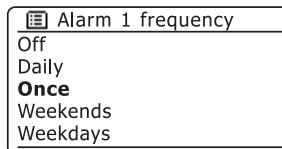
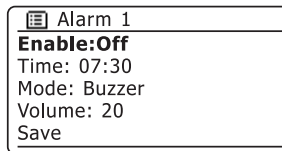

Setting the alarm clock - cont.

10. Rotate the **Tuning/Select** control until the 'Volume:' option is highlighted on the display and press the control if you wish to change it. The radio uses the saved volume setting for each alarm when it sounds.

Rotate the control to set the required volume and then press the control to confirm the setting.

11. In order to store the alarm settings rotate the **Tuning/Select** control until 'Save' is highlighted. Press the control to store the alarm settings. Your radio will show 'Alarm saved' and will then go back to the list of alarms with the new alarm setting shown in the display.

If you decide not to save the settings, press the **Back** button. The display will show 'Save changes' with a 'YES' or 'NO' option. Rotate the **Tuning/Select** control to choose 'NO' and then press the control. 'Alarm not saved' will show on the display.

Press the **Back** button to exit the Alarms menu.

Active alarms are shown using small alarm indicators at the bottom of the playing displays and on the clock display when in stand-by.

Note: If you make a mistake at any point while setting the alarms, use the **Back** button to go back to the previous screen.

When the alarm sounds

The buzzer or radio alarm will sound at the selected times for up to 60 minutes unless cancelled. The volume used for the alarm will be as specified during the alarm setting procedure. If the radio cannot connect to the specified radio station, the buzzer alarm will be used instead.

To cancel an alarm, press the **On/Off** button to return to stand-by mode.

The alarm icon will flash at the bottom of the playing mode displays, and the radio will automatically switch back to stand-by mode when the 60 minutes have elapsed.

Note: If the radio is switched on because of an alarm you can control basic functions such as volume and selecting presets. You cannot perform operations which involve the Select control since this also acts as the Snooze button (see page 83).

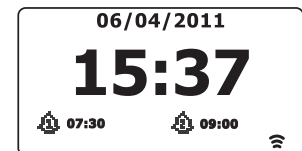
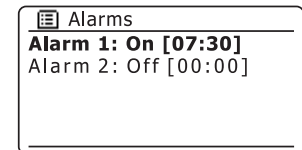
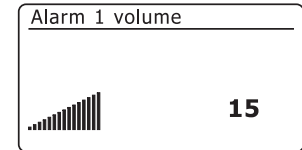
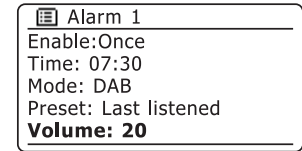
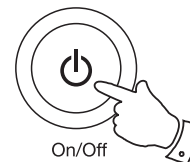
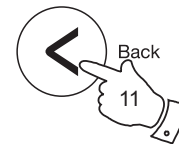
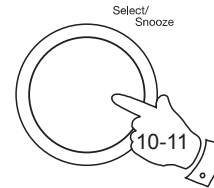

Disabling alarms

1. To disable an alarm enter the alarm setup menu (see page 80) and rotate the **Tuning/Select** control until the desired alarm is highlighted on the display. Press the **Tuning/Select** control.
2. Rotate the **Tuning/Select** control until the 'Enable:' option is highlighted on the display. Press the control.
3. Rotate the **Tuning/Select** control to highlight 'Off' and press the control.
4. Rotate the **Tuning/Select** control until the 'Save' option is highlighted on the display then press the control to save the new setting. The chosen alarm will now be disabled.

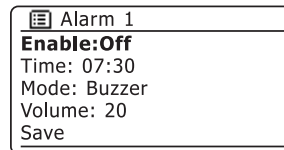
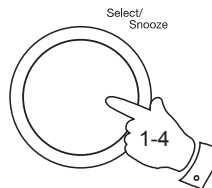

Controlling alarms in stand-by

When your radio is in stand-by the alarms can be controlled using the **Alarm** button. This avoids the risk of disturbance to someone who is asleep.

1. To change the states of the alarms when in stand-by press the **Alarm** button. The display will cycle through none, either and both alarms enabled.
2. To change the alarm settings while the radio is in stand-by, **press and hold** the **Alarm** button. This will cause the *Alarms* menu to be displayed (see page 80 step 3 onwards).

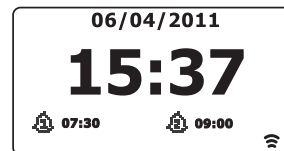
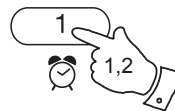

Snooze timer

1. The buzzer or radio alarm can be silenced for 5 minutes by pressing the **Tuning/Select/Snooze** control. Should you wish for a longer snooze duration this can be extended. Pressing the control again while the radio is snoozed will set the available snooze time to 5, 10, 15 or 30 minutes.
2. While the snooze timer is active the remaining snooze time is shown next to the flashing alarm icon on the clock display.
3. In order to cancel the Snooze timer while the alarm is suspended, press the **On/Off** button. The display will briefly show an 'Alarm Off' message.

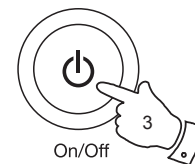
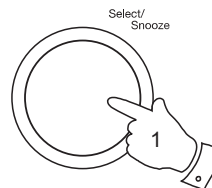

Sleep timer

Your radio can be set to turn off after a preset time has elapsed. The sleep timer setting can be adjusted between 15 and 120 minutes in 15 minute increments.

1. Press the **On/Off** button to switch on your radio.
2. Access the menu for the current mode by pressing the **Menu** button. Rotate the **Tuning/Select** control until 'Main menu' is highlighted on the display. Press the control to enter the 'Main menu'.
3. Rotate the **Tuning/Select** control until 'Sleep' is highlighted on the display then press the **Tuning/Select** control.
4. Rotate the **Tuning/Select** control until the required sleep time setting is selected. Press the **Tuning/Select** control to confirm the setting. The sleep timer can be set to between 15 and 120 minutes, or to Off.
5. Your radio will switch into stand-by mode after the preset time has elapsed. If running on batteries it will switch off completely shortly afterwards.
An active sleep timer is shown using a small timer indicator at the bottom of the playing displays. This indicator also shows the sleep time remaining before the radio switches itself into stand-by mode.
6. To cancel the sleep timer before the preset time has elapsed and to turn off the radio, press the **On/Off** button to turn the radio off manually.
To cancel the sleep timer and leave the radio playing, go back into the sleep timer settings (steps 1 to 4 above) and select the Off option in step 4. Alternatively, simply press the **On/Off** button twice in succession to cancel the timer and switch the radio back on again.

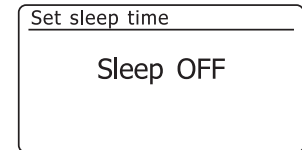
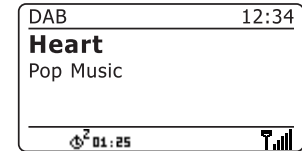
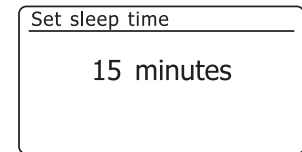
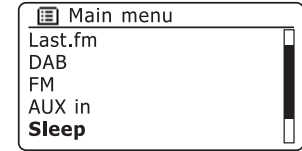
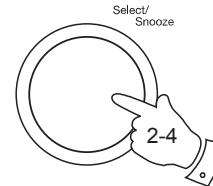
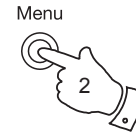
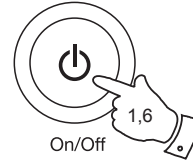

Brightness control

The brightness of the display can be adjusted for when the radio is in Stand-by and for when it is in use. If you use the unit in the bedroom, you may prefer a lower stand-by brightness level than the standard setting. There are three brightness levels and an almost off 'night-time' setting.

1. Press the **On/Off** button to switch on your radio. Access the menu for the current mode by pressing the **Menu** button.
2. Rotate the **Tuning/Select** control until '*System settings*' is highlighted on the display. Press the control to enter the system settings menu. Rotate the **Tuning/Select** control until '*Brightness*' is highlighted on the display. Press the control.
3. To adjust the display brightness when the radio is switched on rotate the **Tuning/Select** control until '*Normal*' is highlighted on the display. To adjust the display brightness when the radio is in stand-by rotate the **Tuning/Select** control until '*Standby*' is highlighted. Press the control to enter the selected brightness adjustment mode.
4. To adjust the brightness level rotate the **Tuning/Select** control clockwise to increase the brightness level and anti-clockwise to decrease it. The backlight level will change as the control is rotated so that you can see the effect of each setting. Note that the backlight is almost completely off at the zero setting. Press the control to set the level. Press the **Menu** button to exit.

When the radio is in Stand-by mode, pressing a button or turning the rotary control will cause the radio to switch to the Normal brightness level for a few seconds. This is so that even if the Stand-by brightness level is set to zero (almost off), it is still possible to see the time by quickly pressing a button.

Menu

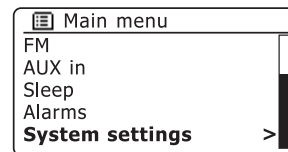

Select/
Snooze

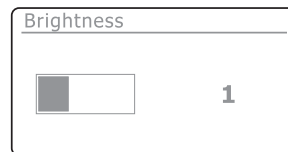
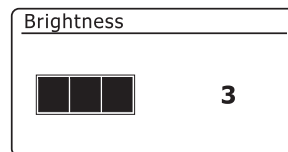
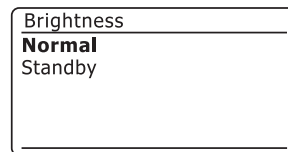
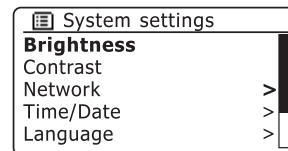
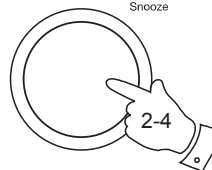

Contrast / viewing angle control

The contrast of the display can be adjusted. The adjustment also changes the angle from which the display can best be seen.

1. Access the menu for the current mode by pressing the **Menu** button. Rotate the **Tuning/Select** control until 'System settings' is highlighted on the display. Press the control to enter the settings menu.
2. Rotate the **Tuning/Select** control until 'Contrast' is highlighted on the display and press the control.
3. Rotate the **Tuning/Select** control to adjust the contrast and viewing angle. The contrast level indication on the screen will change at the same time. When you find the setting that gives the best legibility for the location in which the radio is used, press the control to save the setting.
4. Press the **Menu** button to exit.

Menu



Select/
Snooze

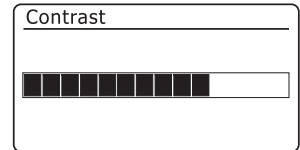
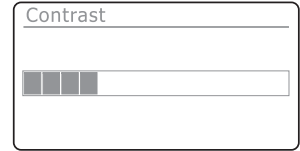
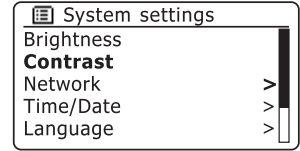
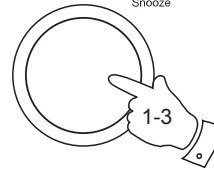

Headphone socket

A 3.5mm stereo **Headphone Socket** located on the rear of your radio is provided for use with headphones. Inserting a plug automatically mutes the internal loudspeaker.

Please be aware that the sensitivity of headphones can vary widely. We therefore recommend setting volume to a low level before connecting headphones to the radio.

IMPORTANT: Excessive sound pressure from earphones and headphones can cause hearing loss.

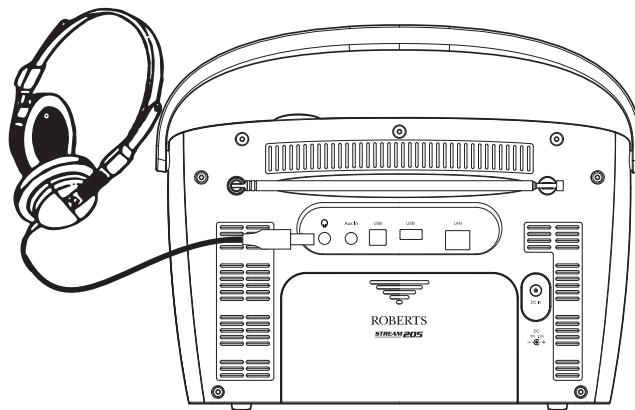

Auxiliary input socket

A 3.5mm stereo **Auxiliary Input** socket located on the rear of your radio is provided for connecting the audio signal from an external audio source such as an iPod, MP3 or CD player.

1. Connect a stereo lead from the headphone output of your iPod, MP3 or CD player to the Aux In socket located at the rear of the radio. Typically this lead will have a 3.5mm stereo plug at both ends.
2. Switch on your radio.
3. Press the **Mode** button until *AUX in* mode is shown on the display.
4. Press the 'play' on the connected audio device. Use the volume control on the connected device to adjust the volume from the radio.

Note: The radio's volume control will have no effect in Aux In mode.

5. After use, disconnect your player in order to listen to your radio conventionally. Either switch off your radio or select an alternative operating mode using the **Mode** button.

Note: If you do not disconnect your player when you switch to other modes, you may find that the audio volume from the radio is reduced, or that you can hear the player and the radio at the same time.

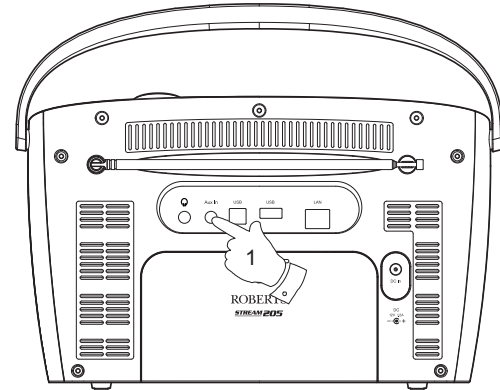

Mode

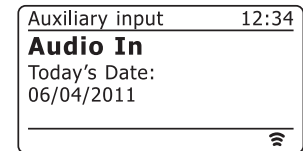
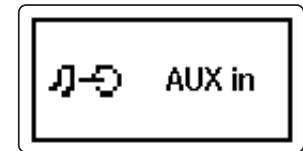

Information

Factory reset

If you wish to completely reset your radio to its initial state this may be performed by following this procedure. By performing a factory reset, all user entered settings will be erased.

1. Access the menu for the current mode by pressing the **Menu** button. Rotate the **Tuning/Select** control to highlight the 'Main menu' option, then press the control to select.
2. Rotate the **Tuning/Select** control until 'System settings' is highlighted and then press the control to select.
3. Rotate the **Tuning/Select** control until 'Factory Reset' is highlighted and then press the control. Rotate the **Tuning/Select** control and highlight 'YES' to proceed.

If you do not wish to carry out a system reset, highlight 'NO' and then press the control. The display will revert to the previous menu.

4. With 'YES' highlighted, press the **Tuning/Select** control. The radio will restart as if first plugged in and a full reset will be performed. The DAB stations list together with any preset stations will be erased and your wireless network connection details will be lost. All configuration settings will be restored to their defaults, the clock and alarms will be reset. The radio will then launch the 'Setup wizard'. If you wish to leave the radio in a reset condition, switch off the radio at this point.

In case of malfunction for any reason, reset the product as described above to resume normal operation. It may be necessary in some cases to disconnect the mains power and batteries, then reconnect power after 10 seconds.

In case of malfunction due to electrical fast transient (burst), reset the product as above (reconnection of the power source may be required) to resume normal operation.

Menu



Select/
Snooze

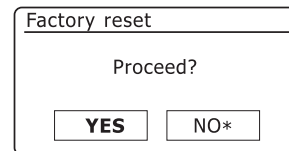
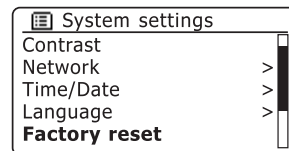
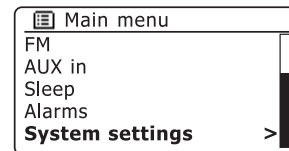
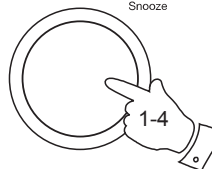

Software update

From time to time, new software features for your radio may be developed. Your radio has therefore been designed to allow its internal software to be updated using your Internet connection.

You should not attempt to update your radio unless it is recommended to you by Roberts Customer Services. Updating the software may remove all network settings, radio station presets and alarm settings from your radio.

It is important that you do not attempt this procedure unless you have a good Internet connection and a reliable mains power supply. Make sure that your WiFi connection is reliable before proceeding.

Your radio will not be able to update its software while it is running on batteries.

1. The '*Software update*' option is accessed via the '*System settings*' menu. When you select '*Software update*' the menu will display '*Auto check setting*' and '*Check now*'. If you want your radio to check periodically for new software versions rotate the **Tuning/Select** control to highlight '*Auto check settings*'. Then press the control and select '*YES*'. If you do not want your radio to check for updates select the '*NO*' option.
2. To check if there are any software updates available currently, rotate the **Tuning/Select** control to highlight '*Check now*' and then press the control. The radio will check to see if an update is available. The display will show '*Checking for new versions*'. If there are no updates then the display will show '*Software up to date*'. If a software update is available your radio will then offer the choice of updating the software or not, displaying '*New version available. Update software?*'. Select the '*YES*' option if you wish to go through the update process.
3. If you choose to update your radio it will first download the new software and will then reprogram its internal memory. This may take a few minutes depending on the speed of your internet connection.
4. Once the software update is completed, the radio will prompt you to press **Select** to restart. Press the **Tuning/Select** control and your radio will then restart. You may find that you will need to reconfigure your network connection following an update. You may also need to re-enter all radio station presets, alarm settings, and configuration options.

VERY IMPORTANT: Do not switch off the power to the radio until the update operation is complete and the radio has restarted, otherwise the unit may become permanently damaged.

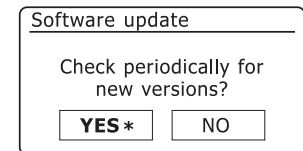
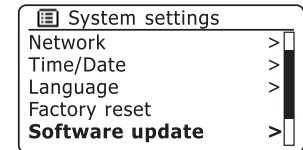
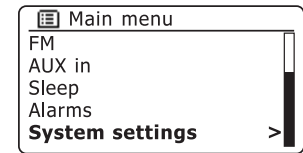

Network profiles

Each time that you connect your radio to a WiFi network, the radio will store the details of that connection (SSID, security key, DHCP/IP address settings) as a profile. Up to four such profiles are stored in the radio so that if the unit is used in multiple locations there is no need to enter the network settings when returning to a location previously visited.

The radio stores the four most recent profiles in memory identified by their SSID. Normally the radio will attempt to connect to one of the stored profiles and only if it is unable to do so will you need to use the Network Wizard (see page 17).

In the event that you visit a location only once you may wish to delete the profile for the network in that location to avoid losing other profiles.

1. Access the menu for the current mode by pressing the **Menu** button. Rotate the **Tuning/Select** control until 'System settings' is highlighted on the display. Press the control to enter the settings menu.
2. Rotate the **Tuning/Select** control until 'Network' is highlighted on the display. Press the control to enter the *Network settings* menu.
3. Rotate the **Tuning/Select** control until 'Network profile' is highlighted on the display. Press the control to see the stored profiles. The profile which is currently in use (if any) is marked with an asterisk.
4. To remove a profile from memory, rotate the **Tuning/Select** control to highlight the profile to be deleted and then press the control.
5. The radio will offer a 'YES' or 'NO' selection. Rotate the **Tuning/Select** control to select 'YES' and then press the control. The selected profile will be deleted.

Note that it is not possible to delete a profile which is currently in use.

Menu



Select/
Snooze

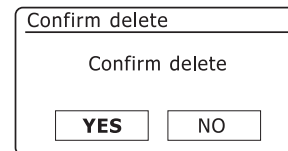
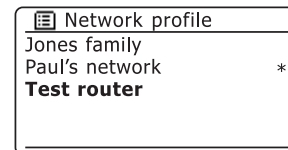
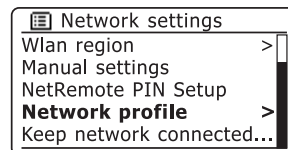
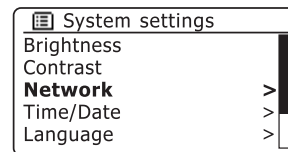
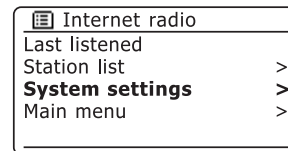
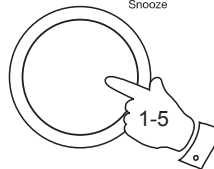

Software version display

The software version display is provided for reference and customer support purposes.

1. Access the menu for the current mode by pressing the **Menu** button. Rotate the **Tuning/Select** control until 'System settings' is highlighted on the display. Press the control to enter the *System settings* menu.
2. Rotate the **Tuning/Select** control until 'Info' is highlighted on the display. Press the control to display the software version and radio ID.
3. Press the **Menu** button to exit.

Menu



Select/
Snooze

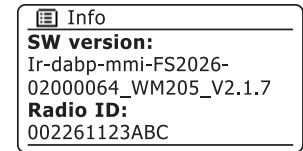
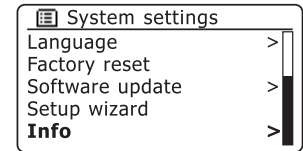
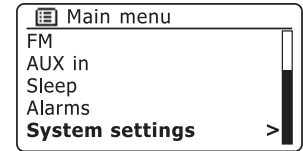
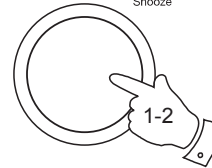

Audio FAQ

Your radio can access some audio help for Internet Radio use.

1. With your radio switched on and in the **Internet Radio** mode, press the **Menu** button. Rotate the **Tuning/Select** control until 'Station list' is highlighted on the display. Press the **Tuning/Select** control.
2. Rotate the **Tuning/Select** control until 'Help' is highlighted on the display. Press the **Tuning/Select** control to enter the Help menu.
3. Rotate the **Tuning/Select** control until 'FAQ' is highlighted. Press the control to display some frequently asked questions.
4. Rotate the **Tuning/Select** control to choose a question that suits your requirements and press the control to listen to the answer. Adjust the volume as needed.

Menu



Select/
Snooze

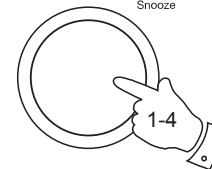

Troubleshooting

If you experience any trouble with your radio, then you may find it useful to visit the help section on our web site at

http://www.robertsradio.co.uk/pages/stream205_faq.htm

If you have difficulty connecting the radio to your computer network, some of these steps may help to resolve the problem:

1. Confirm that a WiFi connected PC can access the Internet (i.e. can browse the web) using the same network.
2. Check that a DHCP server is available (normally a router function). Your radio will by default use DHCP unless you choose to disable it. This may be configured using the menu items *'Main Menu' -> 'System settings' -> 'Network' -> 'Manual settings'*. This will ask first whether you wish to configure a wired or a wireless connection. For either wired or wireless you then need to choose *'DHCP enable'* or *'DHCP disable'*. If you enable DHCP then the radio will negotiate with your router (or DHCP server) and will be provided with an IP address as well as the other settings needed. If you wish to set the network configuration manually, refer to paragraph 6.
3. Check that your network's firewall is not blocking any outgoing ports. As a minimum, the radio needs access to UDP and TCP ports 80 and 123. Port 53 may be required for DNS. Some Internet radio services may require additional ports to be open. Windows Media Player 11 or 12 will allocate a port number for UPnP media sharing and will configure Microsoft's Windows built-in firewall appropriately. Other firewall software may require configuration for UPnP or to allow particular IP addresses to have trusted access.
4. Check that your access point does not restrict connections to particular MAC addresses (sometimes called MAC address filtering).

You can view the radio's MAC address using the menu items *'Main Menu' -> 'System settings' -> 'Network' -> 'View settings' -> 'MAC address'*.

The MAC address will typically be of the form

00 : 22 : 61 : xx : xx : xx

5. If you have an encrypted network, check that you have entered the correct encryption key into the radio. Remember that text-format WPA keys are case sensitive. If your radio displays *'Network error'* when attempting to connect to an encrypted network, then please ensure that you enter the correct key for the network. If the problem persists, then you may need to re-check your network configuration.
6. If you need to set up your radio's IP address manually, you will need to know low-level details of your network's configuration. Use the menu items *'Main Menu' -> 'System settings' -> 'Network' -> 'Manual settings' -> 'Wired'* or *'Wireless'* (as needed) -> *'DHCP disable'*.

The radio will then prompt you in turn for the

Ethernet IP address

Ethernet Subnet mask

Ethernet Gateway address

Ethernet Primary DNS

Ethernet Secondary DNS

If you are setting up a wireless connection manually you will also need to enter the SSID, the encryption type, and the encryption key.

See page 18 for full details on how to set up your radio's network configuration manually.

Troubleshooting - cont.

If your radio can connect to the network, but is unable to play a particular internet radio station, it may be due to one these causes:

1. The station is not broadcasting at this time of the day.
2. The station has reached its maximum allowed number of simultaneous connections.
3. The Internet connection between your radio and the server (often located in a different country) is slow. This could be due to internet congestion, either locally or at a distance.
4. The station may choose to block internet connections to your geographic region (sometimes known as geo-locking).
5. The station is no longer broadcasting. The database of radio stations that your radio connects to is frequently updated and checked but may not always be completely accurate.
6. The radio station is broadcasting using an audio format which is not playable by your radio (although the Stream 205 does play the most popular formats used by regular broadcasters).

Try using a PC to listen via the broadcaster's web site or via the radio station database web site at <http://www.wifiradio-frontier.com>. If you can play the station with a PC, it may be that the internet feed or local network connection is poor. However, some broadcasters (such as the BBC) provide different data streams for PC users and internet radio listeners, so this test is not always conclusive.

If you cannot play the station via your PC this may indicate that the problem is not necessarily due to your radio, but it could be your network, your internet connection, the broadcaster, or internet congestion.

Music Player / UPnP problems

The use of the Music Player function with UPnP should be straightforward. However, the power that UPnP offers by allowing devices to connect with each other means that it is often disabled by default by security applications such as third party firewall software and in routers.

If you are using Windows Media Player (WMP) as your UPnP server, and if it fails to operate with your radio, please keep this fact in mind: *A fresh installation of Windows and Windows Media Player when using Microsoft's built-in firewall software will normally work.* If you have trouble getting UPnP working it is generally because of some other software that has been added to your computer.

If UPnP does not work as expected, possible reasons may include:

- UPnP functions blocked in firewall software
- UPnP functions turned off by security software
- UPnP functions 'hi-jacked' by other software
- UPnP functions blocked in the router
- Multi-cast packets blocked in the router
- IP address of system blocked in firewall software

Some third-party UPnP servers are much less dependent upon other parts of Windows than WMP 11 or 12. If the greater flexibility that these offer is attractive, then it may be found in some cases that they are easier to get working.

Accessing your audio files via a UPnP server using Windows Vista and XP

If your computer is running Windows Vista or XP, then Windows Media Player version 11 (also referred to here as WMP 11) includes a UPnP server which will make your files available to your radio. There are other UPnP server solutions available for non-Windows users and for Windows users who may wish to use an alternative (see page 36).

It is beyond the scope of this instruction book to cover all possible options for UPnP. We explain the use of Microsoft's Windows Media Player here since that will be the first choice for the majority of users.

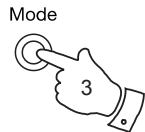

Set up UPnP access on a Windows PC

1. If your PC is running Microsoft Windows Vista or Windows XP then you can use Microsoft's Windows Media Player version 11 to act as your UPnP (Universal Plug and Play) media server. If not already installed on your PC, Windows Media Player 11 may be downloaded from Microsoft's web site and installed by following the instructions detailed in its installation wizard, or by using Microsoft's Windows Update facility.
2. Once installed, WMP 11 can create a library from all the media files available to it on your PC. To add new media files to the library, select the 'Library' tab, then 'Add to Library... > Advanced Options', click 'Add', choose the files or folders that you wish to add and click 'OK'.

The next step is to connect your radio to WMP 11 and to configure the program to allow the radio to access your media library.

3. Press the **On/Off** button to switch the radio on. Then press the **Mode** button as needed until the *Music Player* mode display is shown. The main '*Music Player*' menu will then be displayed.

Selecting Media Sharing in Windows Media Player 11



Set up UPnP access on a Windows PC - cont.

4. Rotate the **Tuning/Select** control until *'Shared media'* is highlighted and press the control to select. The radio will scan for all available UPnP servers. It may take a few seconds for the radio to complete its scan. The radio will display '<Empty>' if no UPnP servers are found.
5. After scanning, select your UPnP server using the **Tuning/Select** control. If you are using Windows Media Player 11 as the server, your radio will then normally display *'Unauthorised'* at this stage.
6. Your PC may prompt you that there has been a connection to your UPnP server. Whether prompted or not, in order that the radio may access the music files, you will need to click the *'Library'* tab in WMP 11 and select the *'Media Sharing...'* item to open the *'Media Sharing'* window. Make sure the box *'Share my media to:'* is ticked.
7. In the *'Media Sharing'* window, the radio will be listed as an unknown device. Click on the unknown device shown to select it, then click the *'Allow'* button and then click *'OK'*.
 Note: If you are using Microsoft Windows' firewall software, this should be correctly configured by WMP 11. If you are using third party firewall software you may need to manually configure it to allow your unit and WMP 11 to communicate (see the *'Troubleshooting'* section on page 93).
8. On the radio, select the named server again using the **Tuning/Select** control. If WMP 11 is now able to communicate with your radio you will be presented with some media selection options on the display.

In the event that you are unable to make your radio work with WMP 11 then the reason is most likely related to security settings in your software firewall or router. Please refer to *'MusicPlayer / UPnP problems'* on page 94.

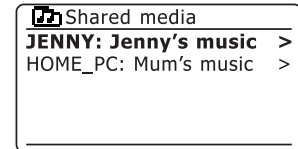
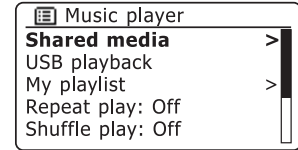
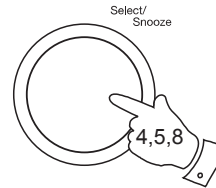

Allowing a device to connect to Windows Media Player 11

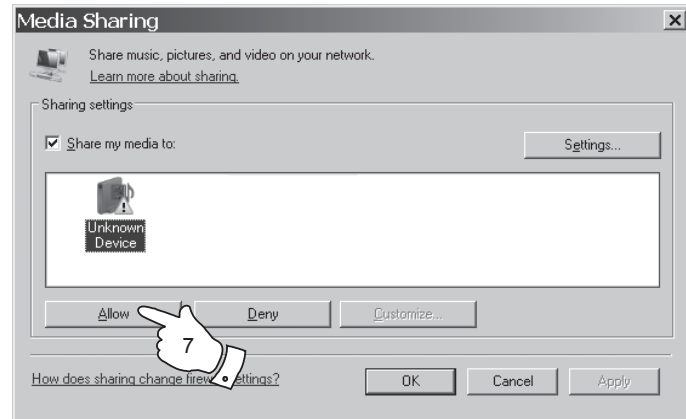

Audio codecs

Your radio supports a range of audio codecs which provide compatibility with a wide range of Internet Radio stations. These also allow users to stream music from their computers or to play directly from USB flash memory devices.

Note that for any given audio codec, there are many streaming protocols available, and thus even if an Internet Radio station uses a supported format, this does not guarantee that every such station will work with your radio. The radio stations database to which your radio connects is checked for compatibility so that most stations should be playable without problems. Similarly when streaming media from a computer, while a codec may be supported, there can be many subtle variations in formats, tagging schemes and protocols (even within UPnP). In general your radio will play the supported formats with most common UPnP servers.

The following table summarises the maximum supported bit-rates for the various audio formats that are playable on your radio. Higher rates may be playable in some cases but performance of the product may be affected.

Codec	Maximum supported data rate
AAC (LC)	320 kbits/sec
FLAC ⁽¹⁾	1.536 Mbits/sec
LPCM ⁽²⁾	1.536 Mbits/sec
MP3	320 kbits/sec
Real Audio	64 kbits/sec
WAV ⁽³⁾	1.536 Mbits/sec
WMA ⁽⁴⁾	320 kbits/sec

All codecs support 2-channel (stereo) coded files only.

All codecs support sample rates up to 48 kbits/sec (includes 32 and 44.1 kbits/sec).

Files which have Digital Rights Management (DRM) protection applied will not be playable on your radio.

(1) 16 and 24 bit samples are supported in FLAC files.

(2) The maximum supported bit-rate is for 48 kHz sampling, 2 channels and 16-bits per sample.

(3) 16 bit LPCM only

(4) WMA Lossless, WMA Voice, WMA 10 Professional, and files which have DRM protection are not supported.

Cautions

Do not allow your radio to be exposed to water, steam or sand.

Do not leave your radio where excessive heat could cause damage.

The name plate is located on the rear of the radio.

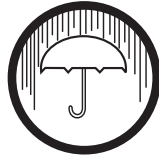

- The radio shall not be exposed to dripping or splashing and no objects filled with liquids, such as vases, shall be placed on the radio.
- It is recommended to operate the product such that there is a minimum distance (10cm recommended) to adjacent objects in order to ensure good ventilation.
- The ventilation of the product should not be restricted by covering it with items such as newspapers, tablecloths, curtains etc.
- No naked flame sources such as lighted candles should be placed on the product.
- It is recommended to avoid using or storing the product at extremes of temperature. Avoid leaving the unit in cars, on window sills, in direct sunlight etc.
- The radio must be used in a moderate climate.

Specifications

Power Requirements

Mains	110-240 volts AC, 50Hz  only (use only supplied adaptor)
Batteries	6 x LR20 (D size) alkaline cells (see also page 7).

Battery life

Up to 40 - 80 hours of listening for 4 hours a day at normal volume using alkaline cells, depending on operating mode (see also page 7).

Connectivity

Wired Ethernet	10/100M bits/sec via RJ-45 socket
WiFi	802.11b and 802.11g supported with WEP and WPA/WPA2 encryption Compatible with 802.11n routers which offer mixed mode support for 802.11b/g

Frequency Coverage

FM	87.5 - 108MHz
DAB	174.928 - 239.200MHz

Circuit features

Loudspeaker	2 x 76 mm
Output Power	2 x 3 Watts
Headphone socket	3.5mm stereo
Aux In socket	3.5mm stereo
Aerial System	WiFi Built-in antenna
	DAB Telescopic aerial
	FM Telescopic aerial

The Company reserves the right to amend the specification without notice.

Software license information

Use of the software in this radio is subject to software licence terms contained in this user manual - by using the radio, you are agreeing to comply with these licence terms:

MPEG Layer-3 audio coding technology licensed from Fraunhofer IIS and Thomson

MPEG-4 HE-AAC audio coding technology licensed by Fraunhofer IIS.

<http://www.iis.fraunhofer.de/amm/>



RealNetworks is a trademark or a registered trademark of RealNetworks, Inc.

Portions of this software are included under license from RealNetworks, Inc. Copyright 1995 to 2007, RealNetworks, Inc. All rights reserved.

This product is protected by certain intellectual property rights of Microsoft. Use or distribution of such technology outside of this product is prohibited without a license from Microsoft.

If you download a software upgrade to your radio, additional licence terms may apply and these are available at:

<http://www.frontier-silicon.com/audio/eula.htm>

Guarantee

This instrument is guaranteed for twelve months from the date of delivery to the original owner against failure due to faulty workmanship or component breakdown, subject to the procedure stated below. Should any component or part fail during this guarantee period it will be repaired or replaced free of charge.

The guarantee does not cover:

1. Damage resulting from incorrect use.
2. Consequential damage.
3. Receivers with removed or defaced serial numbers.

N.B. Damaged or broken aerials will not be replaced under guarantee.

Procedure:

Any claim under this guarantee should be made through the dealer from whom the instrument was purchased. It is likely that your Roberts' dealer will be able to attend to any defect quickly and efficiently but should it be necessary the dealer will return the instrument to the Company's service department for attention. In the event that it is not possible to return the instrument to the Roberts' dealer from whom it was purchased, please contact Roberts Radio Technical Services at the address shown overleaf.

These statements do not affect the statutory rights of a consumer.

ROBERTS RADIO TECHNICAL SERVICES

97-99 Worton Road
Isleworth
Middlesex
TW7 6EG

Technical Helpline :- 020 8758 0338 (Mon-Fri during office hours)

Web site: <http://www.robertsradio.co.uk>



Issue 2

© 2010, 2011 Roberts Radio Limited

