

Sensing range
5 mm

Inductive sensor

- Short-circuit protection (pulsed)
- Robust brass housing, nickel-plated with fine thread M18 x 1 mm
- Enclosure rating IP 67
- High switching frequency

Dimensional drawing

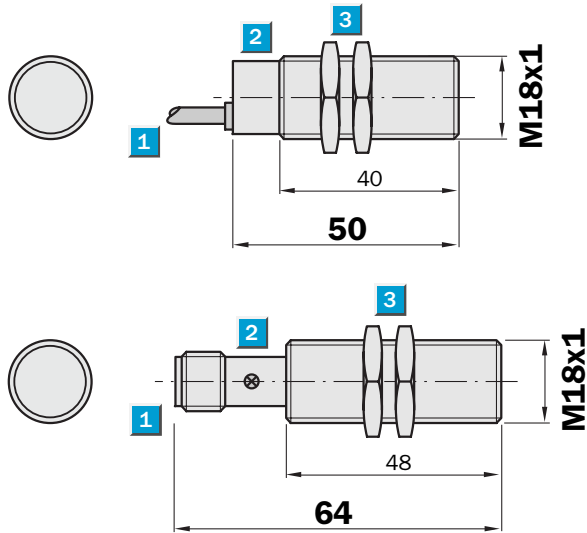

- 1 Connection
- 2 Display LED
- 3 Fastening nuts (2 x); width across 24, metal

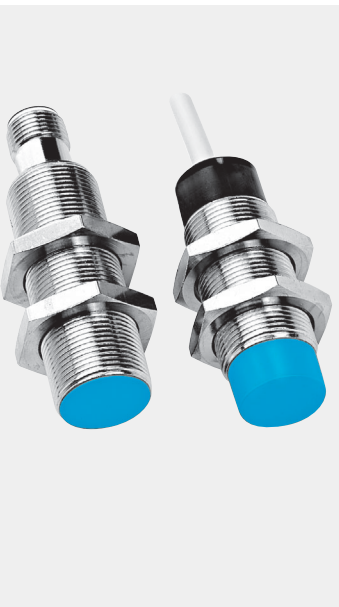

Connection type

IM18-05BNS-ZW1	IM18-05BNS-ZC1	IM18-05BPO-ZC1
IM18-05BPO-ZW1	IM18-05BPS-ZC1	
IM18-05BPS-ZW1		

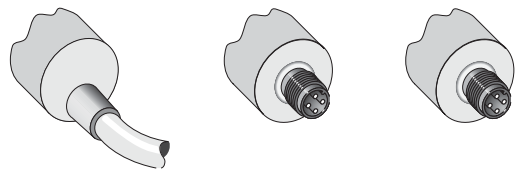

3 x 0.34 mm ²	M12, 4-pin	M12, 4-pin
--------------------------	------------	------------

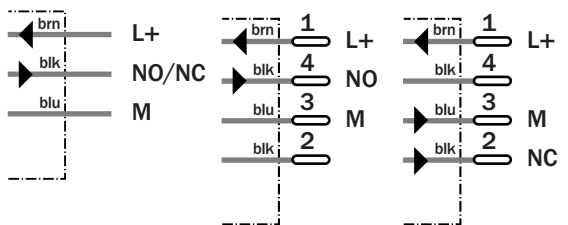

Accessories

Connector, M12, 4-pin

Mounting Systems

Technical data		IM18-	05BNS-ZW1	05BPO-ZW1	05BPS-ZW1	05BNS-ZC1	05BPO-ZC1	05BPS-ZC1				
Sensing range S_n	5 mm											
Electrical configuration	DC 3-wire											
Supply voltage U_v	DC 10 ... 30 V											
Ripple U_{pp}	$\leq 10 \%$											
Voltage drop U_d	$\leq 1 V^1)$											
Power consumption	$\leq 20 mA^2)$											
Continuous current I_a	$\leq 400 mA$											
Time delay before availability t_v	$\leq 100 ms$											
Hysteresis H, of s_r	2 ... 10 %											
Repeatability R	$\leq 2 \%$ (U_b and T_a constant) ³⁾											
Temperature drift, of s_r	$\pm 10 \%$											
EMC	According to EN 60947-5-2											
Switching output	NPN											
	PNP											
Output function	Normally open											
	Normally closed											
Installation	Flush											
Connection type	Cable, PVC, 2 m											
	Connector, M12, 4-pin											
Enclosure rating	IP 67 ⁴⁾											
Max. switching frequency	600 Hz											
Dimensions	M18 x 1 ⁵⁾											
Short circuit protection	✓ ⁶⁾											
Reverse polarity protection	✓											
Power-up pulse suppression	✓											
Shock/vibration stress	30 g, 11 ms/10 ... 55 Hz, 1 mm											
Ambient temperature T_a	-25 °C ... +70 °C											
Housing material	Brass nickel-plated, plastic											
Tightening torque	30 Nm											

1) at I_a max
2) without load

3) of s_r
4) according to EN 60529

5) Thread diameter x pitch (mm)
6) (pulsed)

Order information	
Type	Order No.
IM18-05BNS-ZW1	6 011 988
IM18-05BPO-ZW1	6 011 989
IM18-05BPS-ZW1	6 011 987
IM18-05BNS-ZC1	6 011 992
IM18-05BPO-ZC1	6 011 993
IM18-05BPS-ZC1	6 011 991

Sensing range
8 mm

Inductive sensor

- Short-circuit protection (pulsed)
- Robust brass housing, nickel-plated with fine thread M18 x 1 mm
- Enclosure rating IP 67
- High switching frequency

Dimensional drawing

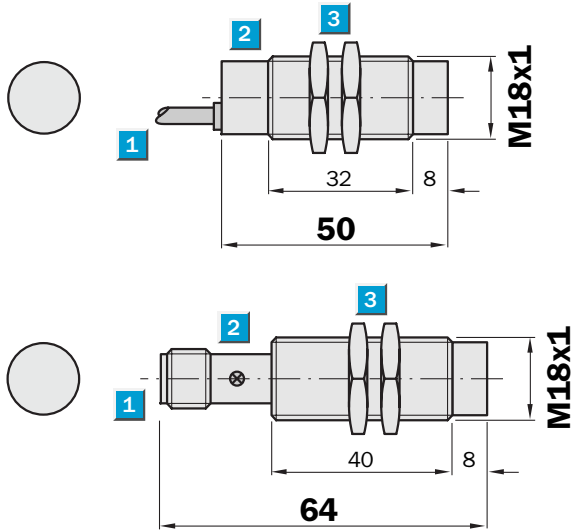

- 1 Connection
- 2 Display LED
- 3 Fastening nuts (2 x); width across 24, metal

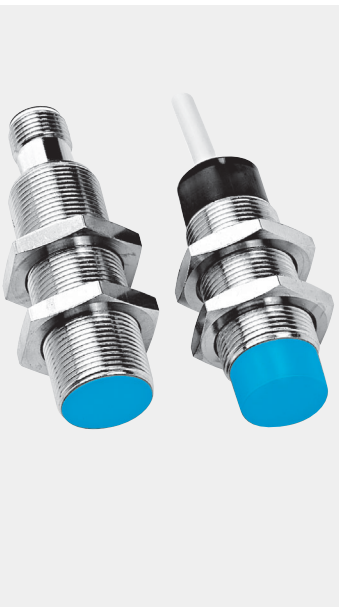

Connection type

IM18-08NNO-ZW1	IM18-08NNS-ZC1	IM18-08NPO-ZC1
IM18-08NNS-ZW1	IM18-08NPS-ZC1	
IM18-08NPS-ZW1		
IM18-08NNS-ZWA		

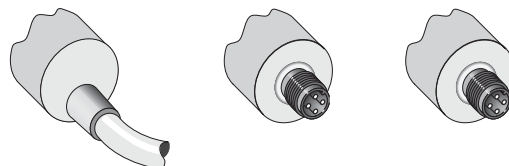

Accessories

Connector, M12, 4-pin

Mounting Systems

3 x 0.34 mm²

M12, 4-pin

M12, 4-pin

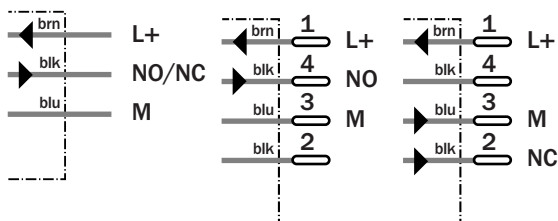

Technical data		IM18-	08NN O-ZW1	08NNS -ZW1	08NPS -ZW1	08NNS -ZWA	08NNS -ZC1	08NPO -ZC1	08NPS -ZC1			
Sensing range S_n	8 mm											
Electrical configuration	DC 3-wire											
Supply voltage U_v	DC 10 ... 30 V											
Ripple U _{pp}	≤ 10 %											
Voltage drop U _d	≤ 1 V ¹⁾											
Power consumption	≤ 20 mA ²⁾											
Continuous current I_a	≤ 400 mA											
Time delay before availability t _v	≤ 100 ms											
Hysteresis H, of s _r	2 ... 10 %											
Repeatability R	≤ 2 % (U _b and T _a constant of U _b) ³⁾											
Temperature drift, of s _r	± 10 %											
EMC	According to EN 60947-5-2											
Switching output	NPN											
	PNP											
Output function	Normally closed											
	Normally open											
Installation	Non-flush											
Connection type	Cable, PVC, 2 m											
	Cable, PVC, 3 m											
	Connector, M12, 4-pin											
Enclosure rating	IP 67 ⁴⁾											
Max. switching frequency	600 Hz											
Dimensions	M18 x 1 ⁵⁾											
Short circuit protection	✓ ⁶⁾											
Reverse polarity protection	✓											
Power-up pulse suppression	✓											
Shock/vibration stress	30 g, 11 ms/10 ... 55 Hz, 1 mm											
Ambient temperature T _a	-25 °C ... +70 °C											
Housing material	Brass nickel-plated, plastic											
Tightening torque	30 Nm											

¹⁾ at I_a max
²⁾ without load

³⁾ of s_r
⁴⁾ according to EN 60529

⁵⁾ Thread diameter x pitch (mm)
⁶⁾ (pulsed)

Order information	
Type	Order No.
IM18-08NNO-ZW1	6 011 998
IM18-08NNS-ZW1	6 011 996
IM18-08NPS-ZW1	6 011 995
IM18-08NNS-ZWA	6 030 123
IM18-08NNS-ZC1	6 012 000
IM18-08NPO-ZC1	6 012 001
IM18-08NPS-ZC1	6 011 999