

GaAs-IR-Lumineszenzdiode
GaAs Infrared Emitter
Lead (Pb) Free Product - RoHS Compliant

SFH 409



Wesentliche Merkmale

- GaAs-LED mit sehr hohem Wirkungsgrad
- Hohe Zuverlässigkeit
- Hohe Impulsbelastbarkeit
- Gute spektrale Anpassung an Si-Fotoempfänger
- Gehäusegleich mit SFH 309, SFH 487

Features

- Very highly efficient GaAs-LED
- High reliability
- High pulse handling capability
- Good spectral match to silicon photodetectors
- Same package as SFH 309, SFH 487

Anwendungen

- IR-Fernsteuerungen von Fernseh-, Rundfunk- und Videogeräten, Lichtdimmern
- Lichtschranken bis 500 kHz
- Münzzähler
- Sensorik
- Diskrete Optokoppler

Applications

- IR remote control for hifi and TV sets, video tape recorders, dimmers
- Light-reflection switches (max. 500 kHz)
- Coin counters
- Sensor technology
- Discrete optocouplers

Typ Type	Bestellnummer Ordering Code	Gehäuse Package
SFH 409	Q62702P0860	3-mm-LED-Gehäuse (T 1), grau eingefärbt, Anschlüsse im 2.54-mm-Raster ($1/10''$), Kathodenkennzeichnung: kürzerer Anschluß 3 mm LED package (T 1), grey-colored epoxy resin, solder tabs lead spacing 2.54 mm ($1/10''$), cathode marking: short lead
SFH 409-2	Q62702P1002	

Grenzwerte ($T_A = 25\text{ °C}$)**Maximum Ratings**

Bezeichnung Parameter	Symbol Symbol	Wert Value	Einheit Unit
Betriebs- und Lagertemperatur Operating and storage temperature range	$T_{op}; T_{stg}$	- 40 ... + 100	°C
Sperrspannung Reverse voltage	V_R	5	V
Durchlaßstrom Forward current	I_F	100	mA
Stoßstrom, $\tau \leq 10\ \mu\text{s}$, $D = 0$ Surge current	I_{FSM}	3	A
Verlustleistung Power dissipation	P_{tot}	165	mW
Wärmewiderstand Thermal resistance	R_{thJA}	450	K/W

Kennwerte ($T_A = 25\text{ °C}$)**Characteristics**

Bezeichnung Parameter	Symbol Symbol	Wert Value	Einheit Unit
Wellenlänge der Strahlung Wavelength at peak emission $I_F = 100\text{ mA}$, $t_p = 20\text{ ms}$	λ_{peak}	950	nm
Spektrale Bandbreite bei 50% von I_{max} Spectral bandwidth at 50% of I_{max} $I_F = 100\text{ mA}$, $t_p = 20\text{ ms}$	$\Delta\lambda$	55	nm
Abstrahlwinkel Half angle	φ	± 20	Grad deg.
Aktive Chipfläche Active chip area	A	0.09	mm ²
Abmessungen der aktiven Chipfläche Dimensions of the active chip area	$L \times B$ $L \times W$	0.3×0.3	mm
Abstand Chipoberfläche bis Linsenscheitel Distance chip surface to lens top	H	2.6	mm
Kapazität, $V_R = 0\text{ V}$ Capacitance	C_o	25	pF

Kennwerte ($T_A = 25\text{ °C}$)

Characteristics (cont'd)

Bezeichnung Parameter	Symbol Symbol	Wert Value	Einheit Unit
Schaltzeiten, I_e von 10% auf 90% und von 90% auf 10%, bei $I_F = 100\text{ mA}$, $R_L = 50\ \Omega$ Switching times, I_e from 10% to 90% and from 90% to 10%, $I_F = 100\text{ mA}$, $R_L = 50\ \Omega$	t_r, t_f	0.5	μs
Durchlaßspannung, Forward voltage $I_F = 100\text{ mA}$, $t_p = 20\text{ ms}$ $I_F = 1\text{ A}$, $t_p = 100\ \mu\text{s}$	V_F V_F	1.30 (≤ 1.5) 1.9 (≤ 2.5)	V V
Sperrstrom, Reverse current, $V_R = 5\text{ V}$	I_R	0.01 (≤ 1)	μA
Gesamtstrahlungsfluß, Total radiant flux $I_F = 100\text{ mA}$, $t_p = 20\text{ ms}$	Φ_e	18	mW
Temperaturkoeffizient von I_e bzw. Φ_e , $I_F = 100\text{ mA}$ Temperature coefficient of I_e or Φ_e , $I_F = 100\text{ mA}$	TC_I	- 0.55	%/K
Temperaturkoeffizient von V_F , $I_F = 100\text{ mA}$ Temperature coefficient of V_F , $I_F = 100\text{ mA}$	TC_V	- 1.5	mV/K
Temperaturkoeffizient von λ_{peak} , $I_F = 100\text{ mA}$ Temperature coefficient of λ_{peak} , $I_F = 100\text{ mA}$	TC_λ	+ 0.3	nm/K

Gruppierung der Strahlstärke I_e in Achsrichtunggemessen bei einem Raumwinkel $\Omega = 0.01\text{ sr}$ **Grouping of Radiant Intensity I_e in Axial Direction**at a solid angle of $\Omega = 0.01\text{ sr}$

Bezeichnung Parameter	Symbol	Werte Values				Einheit Unit
		SFH 409	SFH 409-1 ¹⁾	SFH 409-2	SFH 409-3 ¹⁾	
Strahlstärke Radiant intensity $I_F = 100\text{ mA}$, $t_p = 20\text{ ms}$ $I_F = 1\text{ A}$, $t_p = 100\ \mu\text{s}$	I_e $I_{e\text{ typ.}}$	≥ 6.3 -	6.3 ... 12.5 75	> 10 120	16 ... 32 -	mW/sr mW/sr

¹⁾ Nicht bestellbar als Einzelgruppe.¹⁾ Can not be ordered as single group.

Relative Spectral Emission

$I_{rel} = f(\lambda)$

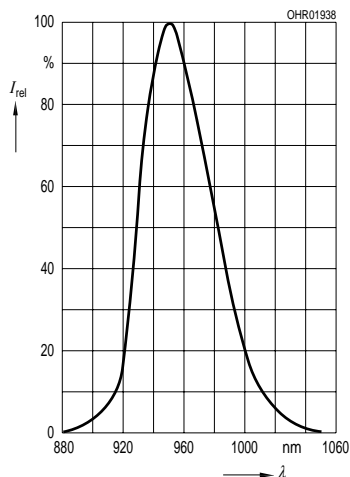

Radiant Intensity $\frac{I_e}{I_e 100 \text{ mA}} = f(I_F)$

Single pulse, $t_p = 20 \mu\text{s}$

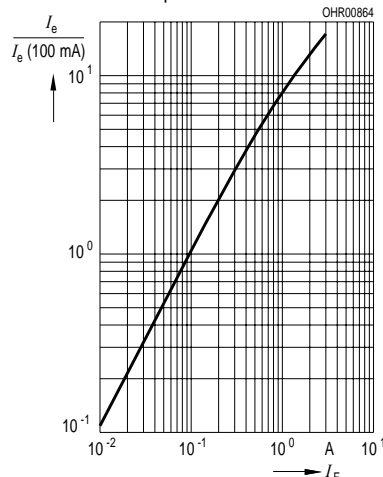

Max. Permissible Forward Current

$I_F = f(T_A)$

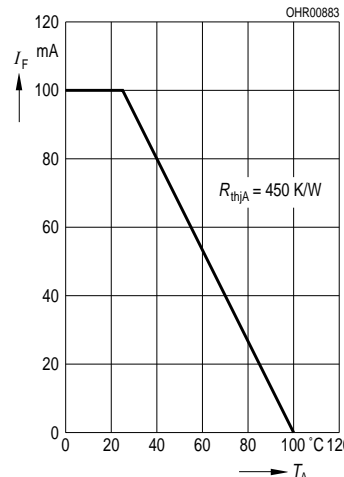

Forward Current

$I_F = f(V_F)$, Single pulse, $t_p = 20 \mu\text{s}$

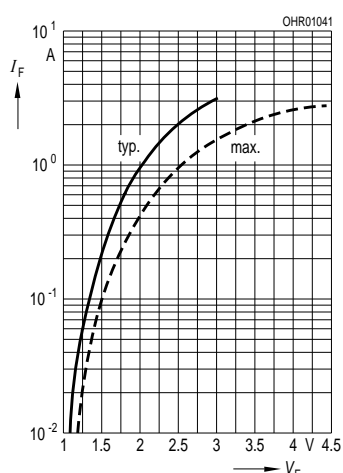

Permissible Pulse Handling Capability

$I_F = f(\tau)$, $T_A = 25^\circ\text{C}$
duty cycle $D = \text{parameter}$

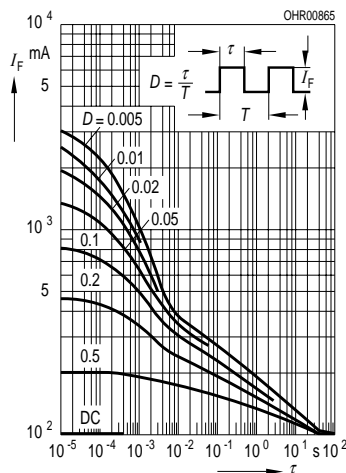

Radiation Characteristics $I_{rel} = f(\varphi)$

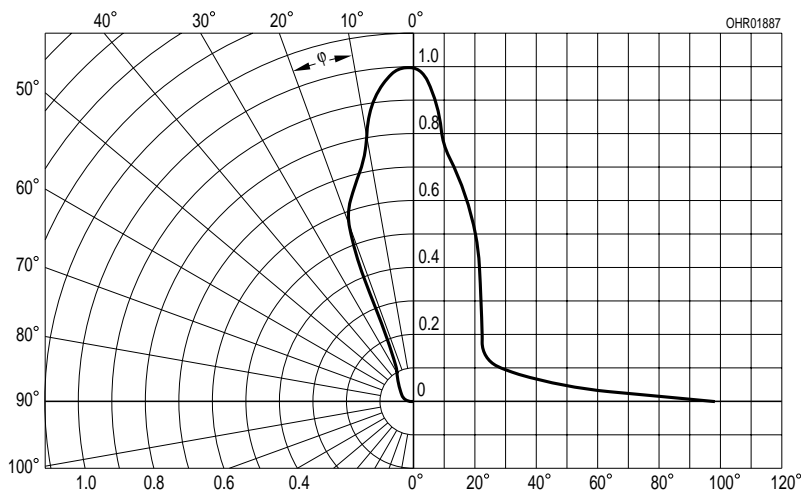

**Maßzeichnung
Package Outlines**

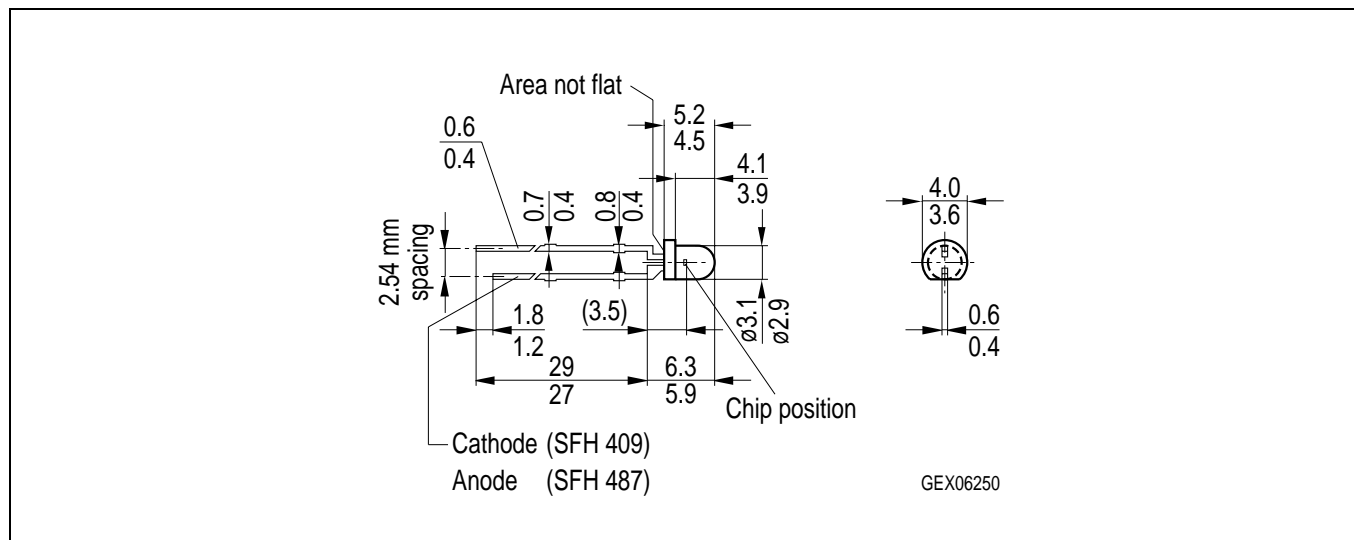

Maße in mm / Dimensions in mm.

**Empfohlenes Lötpaddesign
Recommended Solder Pad**

**Wellenlöten (TTW)
TTW Soldering**

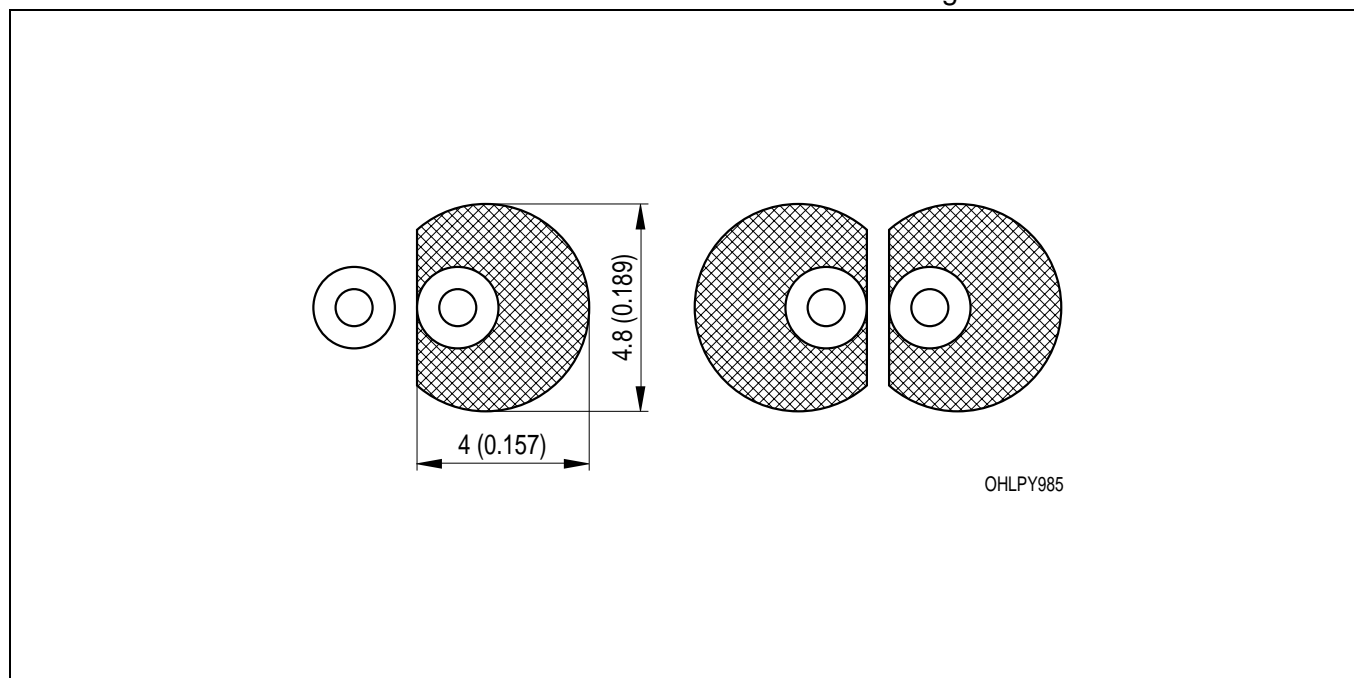

Maße in mm (inch) / Dimensions in mm (inch)

Lötbedingungen
Soldering Conditions
Wellenlöten (TTW)
TTW Soldering

(nach CECC 00802)
(acc. to CECC 00802)

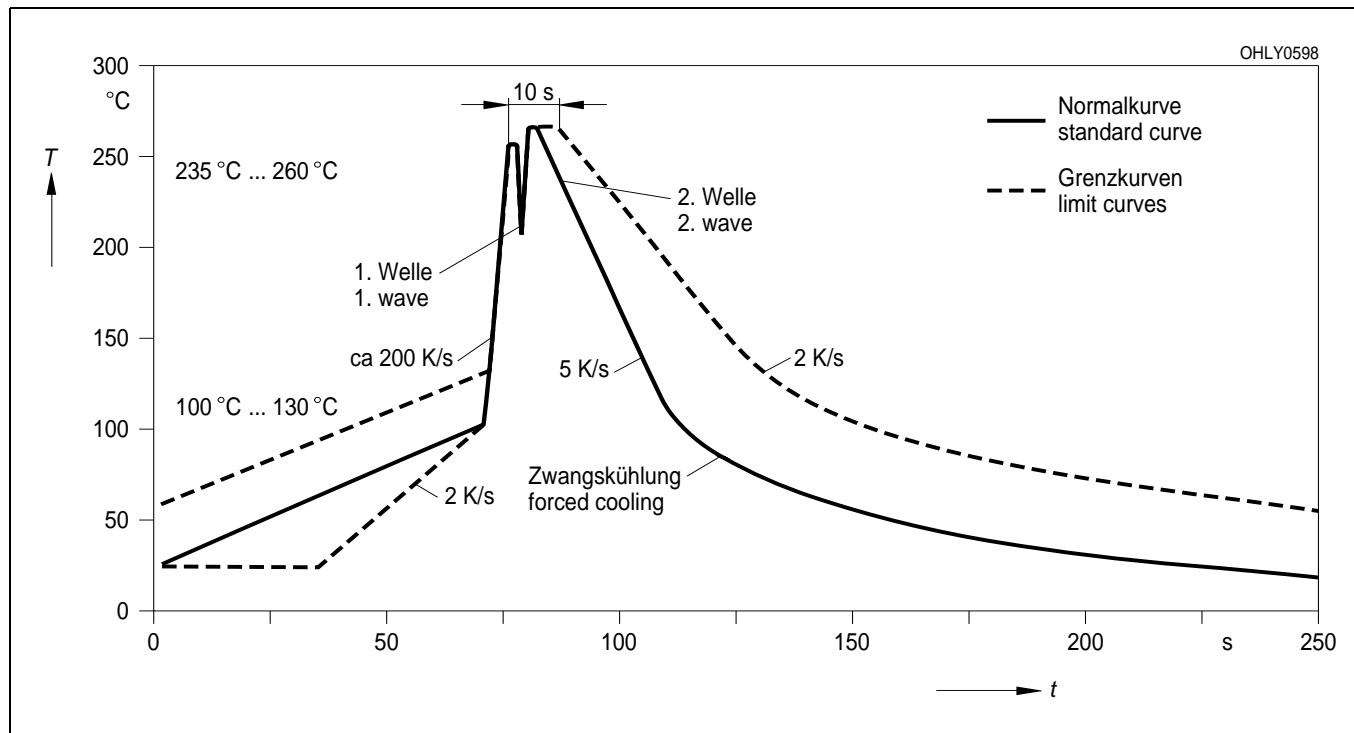

Published by
OSRAM Opto Semiconductors GmbH
Leibnizstrasse 4, D-93055 Regensburg
www.osram-os.com
© All Rights Reserved.

EU RoHS and China RoHS compliant product



此产品符合欧盟 RoHS 指令的要求；

按照中国的相关法规和标准，不含有毒有害物质或元素。

The information describes the type of component and shall not be considered as assured characteristics. Terms of delivery and rights to change design reserved. Due to technical requirements components may contain dangerous substances. For information on the types in question please contact our Sales Organization.

Packing

Please use the recycling operators known to you. We can also help you – get in touch with your nearest sales office. By agreement we will take packing material back, if it is sorted. You must bear the costs of transport. For packing material that is returned to us unsorted or which we are not obliged to accept, we shall have to invoice you for any costs incurred.

Components used in life-support devices or systems must be expressly authorized for such purpose! Critical components ¹, may only be used in life-support devices or systems ² with the express written approval of OSRAM OS.

¹ A critical component is a component used in a life-support device or system whose failure can reasonably be expected to cause the failure of that life-support device or system, or to affect its safety or effectiveness of that device or system.

² Life support devices or systems are intended (a) to be implanted in the human body, or (b) to support and/or maintain and sustain human life. If they fail, it is reasonable to assume that the health of the user may be endangered.