

J-Link / J-Trace User Guide

Document: UM08001
Software Version: 6.46k
Date: July 19, 2019



A product of SEGGER Microcontroller GmbH

www.segger.com

Disclaimer

Specifications written in this document are believed to be accurate, but are not guaranteed to be entirely free of error. The information in this manual is subject to change for functional or performance improvements without notice. Please make sure your manual is the latest edition. While the information herein is assumed to be accurate, SEGGER Microcontroller GmbH (SEGGER) assumes no responsibility for any errors or omissions. SEGGER makes and you receive no warranties or conditions, express, implied, statutory or in any communication with you. SEGGER specifically disclaims any implied warranty of merchantability or fitness for a particular purpose.

Copyright notice

You may not extract portions of this manual or modify the PDF file in any way without the prior written permission of SEGGER. The software described in this document is furnished under a license and may only be used or copied in accordance with the terms of such a license.

© 2004-2019 SEGGER Microcontroller GmbH, Monheim am Rhein / Germany

Trademarks

Names mentioned in this manual may be trademarks of their respective companies.

Brand and product names are trademarks or registered trademarks of their respective holders.

Contact address

SEGGER Microcontroller GmbH

Ecolab-Allee 5
D-40789 Monheim am Rhein

Germany

Tel. +49-2173-99312-0
Fax. +49-2173-99312-28
E-mail: support@segger.com
Internet: www.segger.com

Manual versions

This manual describes the current software version. If you find an error in the manual or a problem in the software, please report it to us and we will try to assist you as soon as possible.

Contact us for further information on topics or functions that are not yet documented.

Print date: July 19, 2019

Manual version	Revision	Date	By	Description
6.47a	0	190511	LG	Chapter "J-Link software and documentation package" * Section "J-Link RTT Viewer": Updated screenshots. * Section "J-Link RTT Viewer": Menu entry 'Channel infos...'. * Section "J-Link Remote Server": Updated list of available command line options.
6.44	4	190424	AG	Chapter "Target interfaces and adapters" * Section "20-pin J-Link connector": Corrected information for pins 14, 16, 18, 20.
6.44	3	190415	LG	Chapter "J-Link software and documentation package" * Updated J-Mem screenshot. Added Chapter "J-Mem"
6.44	2	190408	NV	Chapter "Target interfaces and adapters" * Added diagram showing J-Trace PRO connection with target device.
6.44	1	190321	EL	Chapter "J-Link software and documentation package" * Section "J-Link GDB Server": Command line options corrected.
6.44	0	190306	NV	Chapter "J-Link software and documentation package" * Section "J-Link Commander": Added memory zone example for command "mem".
6.42	0	190215	NV	Chapter "Working with J-Link and J-Trace" * Section "J-Link Script Files": Added new Scripting functions for ETB initialization. Chapter "Working with J-Link and J-Trace" * Section "J-Link Command Strings": Expanded "map region" documentation.
6.40	1	181217	SI	Chapter "J-Link software and documentation package" * Section " J-Link SWO Viewer: Added description of command line option "-usb".
6.40	0	181120	AG	Chapter "ARM SWD specifics" added Chapter "ARM SWD specifics" * Section "SWD multi-drop" added
6.34	10	181025	NV	Chapter "J-Link software and documentation package" * Section "J-Link SWO Viewer": Updated description and pictures.
6.34	9	181023	NV	Chapter "Working with J-Link and J-Trace" * Section "J-Link Command Strings": Added new J-Link command string "RTTtelnetAllowNonLocalClient".
6.34	8	101018	AG	Chapter "Target interfaces and adapters" * Section "19-pin JTAG/SWD and Trace connector": Added information about pitch of connector.
6.34	7	180906	SI	Chapter "J-Link Commander" * Section " Commands: Added description of "VTREF".
6.34	6	180905	NV	Chapter "Working with J-Link and J-Trace" * Section "J-Link Script files": Added new Script file functions to replace generic trace module initializations.
6.34	5	180816	LG	Chapter "J-Link GDB Server" * Section "Supported remote (monitor) commands": Added new monitor command "flash erase".
6.34	4	180704	AG	Chapter "J-Link software and documentation package" * Section "J-Flash Lite" added.
6.34	3	180524	LG	Chapter "J-Link software and documentation package" * Section "J-Link Commander (Command line tool)": Added new command line option "-Log".
6.34	2	180517	LG	Chapter "Open Flashloader" * Section "XML Tags and Attributes": Added new <ChipInfo> attribute "Aliases".

Manual version	Revision	Date	By	Description
6.34	1	180516	NV	Chapter "J-Link software and documentation package" * Section "J-Link SWO Viewer": Refined CL option descriptions.
6.34	0	180511	AG	Chapter "Working with J-Link and J-Trace" * Section "J-Link Command Strings": Added new J-Link command string "SetEnableMemCache". Chapter "Environmental Conditions & Safety" added
6.32	4	180417	NV	Chapter "J-Flash SPI" * Section "Command Line Interface": Updated description of CL option - jflashlog. * Section "Command Line Interface": Updated description of CL option - jlinklog.
6.32	3	180409	NV	Chapter "Working with J-Link and J-Trace" * Section "Script file API functions": Added new API functions "JLINK_MEM_Preserve()", "JLINK_MEM_Restore()", "JLINK_MEM_Fill()".
6.32	2	180327	LG	Chapter "Working with J-Link and J-Trace" * Section "J-Link Command Strings": Added new J-Link command string "MemPreserveOnReset".
6.32	1	180327	AG	Moved contents of chapter "Segger-specific GDB protocol extensions" to separate manual (UM08036)
6.32	0	180323	AG	Moved J-Link GDB Server to separate chapter Added Segger specific GDB protocol extension qSeggerSTRACE:caps Added Segger specific GDB protocol extension qSeggerSTRACE:GetInstStats
6.30	2	180314	AG	Chapter "Working with J-Link and J-Trace" * Section "J-Link Command Strings": Added new J-Link command string "SetAllowStopMode".
6.30	1	180309	NV	Chapter "Working with J-Link and J-Trace" * Section "J-Link Script Files": Added new function SWO_EnableTarget(); * Section "J-Link Script Files": Renamed function GetSWOBaseClock() to SWO_GetSWOBaseClock(); Added unit information of clock speed value.
6.30	0	180206	EL	Chapter "Working with J-Link and J-Trace" * Section "J-Link Script Files": Added new function: HandleBeforeFlashProg(); * Section "J-Link Script Files": Added new function HandleAfterFlashProg();
6.24	1	180124	EL	Chapter "Working with J-Link and J-Trace" * Section "J-Link Comamnd Strings": Updated.
6.24	0	180111	LG	Chapter "J-Link software and documentation package" * Section "J-Link GDB Server": Added new GDBServer monitor commands: ReadAP, ReadDP, WriteAP and WriteDP.
6.22	0	171214	NV	Chapter "Working with J-Link and J-Trace" * Section "J-Link Command Strings": Added new J-Link Command String to set base addresses of coresight components for tracing e.g. CORESIGHT_SetETBBaseAddr. * Section "J-Link script files": Added new function GetSWOBaseClock(); Chapter "J-Link software and documentation package" * Section "J-Link SWO Viewer": Updated picture of new SWO Viewer GUI interface with additional explanation of SWO clock setting.
6.20	8	171123	AG	Chapter "Related Software" * Section "JTAGLoad": PIO commands was listed as supported even though it is not. Fixed. * Section "JTAGLoad": PIOMAP commands was listed as supported even though it is not. Fixed.
6.20	7	171025	EL	Chapter "Monitor Mode Debugging" * Section "Enable Monitor Debugging": Updated
6.20	6	171013	EL	Chapter "Working with J-Link and J-Trace" * Section "J-Link script files": Updated Chapter "Working with J-Link and J-Trace" * Section "J-Link Command Strings": Updated
6.20	5	171011	NG	Updated links to SEGGER wiki: Low power mode debugging J-Link script files

Manual version	Revision	Date	By	Description
				J-Link Command Strings
6.20	4	171011	NG	Chapter "Working with J-Link and J-Trace" * Section "Script file API functions": Added the following functions: JLINK_C2_WriteData() JLINK_C2_ReadData() JLINK_C2_WriteAddr() JLINK_C2_ReadAddr() JLINK_CORESIGHT_ReadDAP() JLINK_GetPinState() JLINK_GetTime() JLINK_JTAG_ReadWriteBits() JLINK_JTAG_StartDR() JLINK_PIN_Override() JLINK_SelectTIF() JLINK_SetDevice() JLINK_SWD_ReadWriteBits() JLINK_TARGET_IsHalted() JLINK_TARGET_Halt() JLINK_TIF_ActivateTargetReset() JLINK_TIF_ReleaseTargetReset() JLINK_TIF_SetSpeed() JLINK_TIF_SetClrTCK() JLINK_TIF_SetClrTMS() JLINK_TIF_SetClrTDI()
6.20	3	171006	NG	Chapter "Working with J-Link and J-Trace" * Section "Script file API functions": Added return values for various functions
6.20	2	171005	EL	Chapter "Open Flashloader" * Section "Add. Info / Considerations / Limitations": Updated
6.20	1	170922	NG	Chapter "Working with J-Link and J-Trace" * Section "J-Link Command Strings": Updated Added new command string "EnableLowPowerHandlingMode"
6.16	0	170320	EL	Chapter "Open Flashloader" Added "AlwaysPresent" as new attribute to the <FlashBankInfo>
6.14	6	170407	NV	Chapter "Working with J-Link and J-Trace" * Section "J-Link scriptfiles": Updated "JLINK_ExecCommand()" description
6.14	5	170320	EL	Chapter "J-Flash SPI" Updated screenshots
6.14	4	170317	NV	Chapter "Working with J-Link and J-Trace" * Section "J-Link scriptfiles": Added: "JLINK_ExecCommand()" Section "Keil MDK-ARM" added for Command string execution
6.14	3	170220	NV	Chapter "Working with J-Link and J-Trace" * Section "J-Link scriptfiles": Added: "OnTraceStart()" and "JLINK_TRACE_Portwidth" Chapter "Trace" * Added crossreference to "JLINK_TRACE_Portwidth"
6.14	2	170216	NV	Chapter "Introduction" *Added Subsubsection "Software and Hardware Features Overview" to all device Subsections. *Edited Subsection "J-Trace ARM." *Section "Target interfaces and adapters": edited "RESET" to "nRESET" and updated description.
6.14	1	170210	NV	Chapter "Working with J-Link and J-Trace" * Section "Exec Commands": Updated SetResetPulseLen TraceSampleAdjust Chapter "Trace" * Section "Tracing via trace pins": Updated
6.14	0	170201	AG	Chapter "Working with J-Link" * Section "Exec Commands": Updated SelectTraceSource SetRAWTRACEPinDelay ReadIntoTraceCache Chapter "Trace" added.

Manual version	Revision	Date	By	Description
6.10a	0	160820	EL	Chapter "Working With J-Link" * Section "Exec Commands": Updated ExcludeFlashCacheRanges.
6.00i	0	160802	EL	Chapter "Introduction" * Removed "Model Feature Lists" Chapter "Adding Support for New Devices": renamed to "Open Flash Loader" Chapter "Open Flash Loader" updated.
6.00	1	160617	EL	Chapter "J-Flash SPI" * Added chapter "Custom Command Sequences"
6.00	0	160519	AG	Chapter "Adding Support for New Devices" added.
5.12f	0	160503	AB	Chapter "Related Software" * Section "J-Link RTT Viewer" updated and moved from section "RTT".
5.12d	1	160427	AG	Chapter "Working with J-Link and J-Trace" * Section "J-Link script files" updated.
5.12d	0	160425	AG	Chapter "Working with J-Link and J-Trace" * Section "J-Link script files" updated.
5.12c	0	160413	NG	Chapter "Related Software" * Section "J-Link Commander" Typo fixed.
5.12c	1	160418	NG	Chapter "Related Software" * Section "J-Link Commander" Commands and commandline options added. Chapter "Working with J-Link and J-Trace" * Section "J-Link Command Strings" Command "SetRTTtelnetPort" added. Chapter "Flash Download" * Section "Debugging applications that change flash contents at runtime" added.
5.10u	0	160317	AG	Chapter "Monitor Mode Debugging" * Section "Target application performs reset" added.
5.10t	0	160314	AG	Chapter "Monitor Mode Debugging" * Section "Enable Monitor Debugging" updated. * Section "Forwarding of Monitor Interrupts" added.
5.10	3	160309	EL	Chapter "J-Flash SPI" updated.
5.10	2	160215	AG	Chapter "RTT" updated.
5.10	1	151204	AG	Chapter "RDI" updated. Chapter "Semihosting" added.
5.10	0	151127	NG	Chapter "Related Software" * Section "J-Scope" removed.
5.02m	0	151125	AG	Chapter "Working with J-Link and J-Trace" * Section "The J-Link settings file" added. Chapter "Low Power Debugging" added.
5.02l	0	151123	AG	Various Chapters * Some typos corrected.
5.02i	1	151106	RH	Chapter "J-Flash SPI" * Section "Send custom commands" added.
5.02i	0	151105	RH	Chapter "Related Software" * Section "J-Link Commander" exec command added. Chapter "Working with J-Link and J-Trace" * Section "J-Link Command Strings" New commands added.
5.02f	1	151022	NG	Chapter "Related Software" * Section "J-Scope" updated.
5.02f	1	151022	EL	Chapter "Target interfaces and adapters" * Section "Reference voltage (VTref)" added.
5.02f	0	151007	RH	Chapter "Working with J-Link and J-Trace" * Section "J-Link script files" updated.
5.02e	0	151001	AG	Chapter "Working with J-Link and J-Trace" * Section "J-Link script files" updated

Manual version	Revision	Date	By	Description
5.02c	1	150925	NG	Chapter "Licensing" * Section "Original SEGGER products" updated. Chapter "Flash download" * Section "Setup for various debuggers (CFI flash)" updated.
5.02c	0	150916	RH	Chapter "Flash download" * Section "Setup for various debuggers (SPIFI flash)" added.
5.02c	0	150914	RH	Chapter "Introduction" * Section "J-Link / J-Trace models" updated. * Section "Supported OS" Added Windows 10
5.02a	0	150903	AG	Chapter "Monitor Mode Debugging" added.
5.02	0	150820	AG	Chapter "Working with J-Link and J-Trace" * Section "J-Link Command Strings" "DisableCortexMXPSRAutoCorrectTBit" added.
5.02	0	150813	AG	Chapter "Monitor Mode Debugging" added.
5.00	1	150728	NG	Chapter "Related Software" * Section "J-Link Commander" Sub-Section "Command line options" updated.
5.00	0	150609	AG	Chapter "Flash download" * Section "QSPI flash support" added. Chapter "Flash breakpoints" * Section "Flash Breakpoints in QSPI flash" added
5.00	0	150520	EL	Chapter "J-Flash SPI" * Initial version added
4.99b	0	150520	EL	Chapter "Related Software" * Section "J-Link STM32 Unlock" Added command line options
4.99a	0	150429	AG	Chapter "Target interfaces and Adapters" Chapter "20-pin J-Link connector", section "Pinout for SPI" added.
4.98d	0	150427	EL	Chapter "Related Software" * Section "Configure SWO output after device reset" updated.
4.98b	0	150410	AG	Chapter "Licensing" * Section "J-Trace for Cortex-M" updated.
4.98	0	150320	NG	Chapter "Related Software" * Section "J-Link Commander" Sub-Section "Commands" added. Chapter "Working with J-Link and J-Trace" * Section "J-Link script files" updated
4.96f	0	150204	JL	Chapter "Related Software" * Section "GDB Server" Exit code description added.
4.96	0	141219	JL	Chapter "RTT" added. Chapter "Related Software" * Section "GDB Server" Command line option "--strict" added. Command line option "--timeout" added.
4.90d	0	141112	NG	Chapter "Related Software" * Section "J-Link Remote Server" updated. * Section "J-Scope" updated.
4.90c	0	140924	JL	Chapter "Related Software" * Section "JTAGLoad" updated.
4.90b	1	140813	EL	Chapter "Working with J-Link and J-Trace" * Section "Connecting multiple J-Links / J-Traces to your PC" updated Chapter "J-Link software" * Section "J-Link Configurator" updated.
4.90b	0	140813	NG	Chapter "Related Software" * Section "J-Scope" added.
4.86	2	140606	AG	Chapter "Device specifics" * Section "Silicon Labs - EFM32 series devices" added
4.86	1	140527	JL	Chapter "Related Software" * Section "GDB Server"

Manual version	Revision	Date	By	Description
				Command line options -halt / -nohalt added. Description for GDB Server CL version added.
4.86	0	140519	AG	Chapter "Flash download" Section "Mentor Sourcery CodeBench" added.
4.84	0	140321	EL	Chapter "Working with J-Link" * Section "Virtual COM Port (VCOM) improved." Chapter "Target interfaces and adapters" * Section "Pinout for SWD + Virtual COM Port (VCOM) added."
4.82	1	140228	EL	Chapter "Related Software" * Section "Command line options" Extended command line option -speed. Chapter "J-Link software and documentation package" * Section "J-Link STR91x Commander" Added command line option parameter to specify a customized scan-chain. Chapter "Working with J-Link" * Section "Virtual COM Port (VCOM) added." Chapter "Setup" * Section "Getting started with J-Link and DS-5"
4.82	0	140218	JL	Chapter "Related Software" * Section "GDB Server" Command line option -notimeout added.
4.80f	0	140204	JL	Chapter "Related Software" * Section "GDB Server" Command line options and remote commands added.
4.80	1	131219	JL/ NG	Chapter "Related Software" * Section "GDB Server" Remote commands and command line options description improved. Several corrections.
4.80	0	131105	JL	Chapter "Related Software" * Section "GDB Server" SEGGER-specific GDB protocol extensions added.
4.76	3	130823	JL	Chapter "Flash Download" * Replaced references to GDB Server manual. Chapter "Working with J-Link" * Replaced references to GDB Server manual.
4.76	2	130821	JL	Chapter "Related Software" * Section "GDB Server" Remote commands added.
4.76	1	130819	JL	Chapter "Related Software" * Section "SWO Viewer" Sample code updated.
4.76	0	130809	JL	Chapter "Related Software" * Sections reordered and updated. Chapter "Setup" * Section "Using JLinkARM.dll moved here."
4.71b	0	130507	JL	Chapter "Related Software" * Section "SWO Viewer" Added new command line options.
4.66	0	130221	JL	Chapter "Introduction" * Section "Supported OS" Added Linux and Mac OSX
4.62b	0	130219	EL	Chapter "Introduction" * Section "J-Link / J-Trace models" Clock rise and fall times updated.
4.62	0	130129	JL	Chapter "Introduction" * Section "J-Link / J-Trace models" Sub-section "J-link ULTRA" updated.
4.62	0	130124	EL	Chapter "Target interfaces and adapters" * Section "9-pin JTAG/SWD connector" Pinout description corrected.
4.58	1	121206	AG	Chapter "Introduction" * Section "J-Link / J-Trace models" updated.

Manual version	Revision	Date	By	Description
4.58	0	121126	JL	Chapter "Working with J-Link" * Section "J-Link script files" Sub-section "Executing J-Link script files" updated.
4.56b	0	121112	JL	Chapter "Related Software" * Section "J-Link SWO Viewer" Added sub-section "Configure SWO output after device reset"
4.56a	0	121106	JL	Chapter "Related Software" * Section "J-Link Commander" Renamed "Commander script files" to "Commander files" and "script mode" to "batch mode".
4.56	0	121022	AG	Renamed "J-Link TCP/IP Server" to "J-Link Remote Server"
4.54	1	121009	JL	Chapter "Related Software" * Section "TCP/IP Server", subsection "Tunneling Mode" added.
4.54	0	120913	EL	Chapter "Flash Breakpoints" * Section "Licensing" updated. Chapter "Device specifics" * Section "Freescale", subsection "Data flash support" added.
4.53c	0	120904	EL	Chapter "Licensing" * Section "Device-based license" updated.
4.51h	0	120717	EL	Chapter "Flash download" * Section "J-Link commander" updated. Chapter "Support and FAQs" * Section "Frequently asked questions" updated. Chapter "J-Link and J-Trace related software" * Section "J-Link Commander" updated.
4.51e	1	120704	EL	Chapter "Working with J-Link" * Section "Reset strategies" updated and corrected. Added reset type 8.
4.51e	0	120704	AG	Chapter "Device specifics" * Section "ST" updated and corrected.
4.51b	0	120611	EL	Chapter "J-Link and J-Trace related software" * Section "SWO Viewer" added.
4.51a	0	120606	EL	Chapter "Device specifics" * Section "ST", subsection "ETM init" for some STM32 devices added. * Section "Texas Instruments" updated. Chapter "Target interfaces and adapters" * Section "Pinout for SWD" updated.
4.47a	0	120419	AG	Chapter "Device specifics" * Section "Texas Instruments" updated.
4.46	0	120416	EL	Chapter "Support" updated.
4.42	0	120214	EL	Chapter "Working with J-Link" * Section "J-Link script files" updated.
4.36	1	110927	EL	Chapter "Flash download" added. Chapter "Flash breakpoints" added. Chapter "Target interfaces and adapters" * Section "20-pin JTAG/SWD connector" updated. Chapter "RDI" added. Chapter "Setup" updated. Chapter "Device specifics" updated.
4.36	0	110909	AG	Chapter "Working with J-Link" * Section "J-Link script files" updated.
4.26	1	110513	KN	Chapter "Introduction" * Section "J-Link / J-Trace models" corrected.
4.26	0	110427	KN	Several corrections.
4.24	1	110228	AG	Chapter "Introduction" * Section "J-Link / J-Trace models" corrected. Chapter "Device specifics" * Section "ST Microelectronics" updated.
4.24	0	110216	AG	Chapter "Device specifics" * Section "Samsung" added. Chapter "Working with J-Link" * Section "Reset strategies" updated.

Manual version	Revision	Date	By	Description
				Chapter "Target interfaces and adapters" * Section "9-pin JTAG/SWD connector" added.
4.23d	0	110202	AG	Chapter "J-Link and J-Trace related software" * Section "J-Link software and documentation package in detail" updated. Chapter "Introduction" * Section "Built-in intelligence for supported CPU-cores" added.
4.21g	0	101130	AG	Chapter "Working with J-Link" * Section "Reset strategies" updated. Chapter "Device specifics" * Section "Freescale" updated. Chapter "Flash download and flash breakpoints" * Section "Supported devices" updated * Section "Setup for different debuggers (CFI flash)" updated.
4.21	0	101025	AG	Chapter "Device specifics" * Section "Freescale" updated.
4.20j	0	101019	AG	Chapter "Working with J-Link" * Section "Reset strategies" updated.
4.20b	0	100923	AG	Chapter "Working with J-Link" * Section "Reset strategies" updated.
0.00	90	100818	AG	Chapter "Working with J-Link" * Section "J-Link script files" updated. * Section "J-Link Command Strings" updated. Chapter "Target interfaces and adapters" * Section "19-pin JTAG/SWD and Trace connector" corrected. Chapter "Setup" * Section "J-Link Configurator added."
0.00	89	100630	AG	Several corrections.
0.00	88	100622	AG	Chapter "J-Link and J-Trace related software" * Section "SWO Analyzer" added.
0.00	87	100617	AG	Several corrections.
0.00	86	100504	AG	Chapter "Introduction" * Section "J-Link / J-Trace models" updated. Chapter "Target interfaces and adapters" * Section "Adapters" updated.
0.00	85	100428	AG	Chapter "Introduction" * Section "J-Link / J-Trace models" updated.
0.00	84	100324	KN	Chapter "Working with J-Link and J-Trace" * Several corrections Chapter Flash download & flash breakpoints * Section "Supported devices" updated
0.00	83	100223	KN	Chapter "Introduction" * Section "J-Link / J-Trace models" updated.
0.00	82	100215	AG	Chapter "Working with J-Link" * Section "J-Link script files" added.
0.00	81	100202	KN	Chapter "Device Specifics" * Section "Luminary Micro" updated. Chapter "Flash download and flash breakpoints" * Section "Supported devices" updated.
0.00	80	100104	KN	Chapter "Flash download and flash breakpoints" * Section "Supported devices" updated
0.00	79	091201	AG	Chapter "Working with J-Link and J-Trace" * Section "Reset strategies" updated. Chapter "Licensing" * Section "J-Link OEM versions" updated.
0.00	78	091023	AG	Chapter "Licensing" * Section "J-Link OEM versions" updated.
0.00	77	090910	AG	Chapter "Introduction" * Section "J-Link / J-Trace models" updated.
0.00	76	090828	KN	Chapter "Introduction" * Section "Specifications" updated * Section "Hardware versions" updated * Section "Common features of the J-Link product family" updated

Manual version	Revision	Date	By	Description
				Chapter "Target interfaces and adapters" * Section "5 Volt adapter" updated
0.00	75	090729	AG	Chapter "Introduction" * Section "J-Link / J-Trace models" updated. Chapter "Working with J-Link and J-Trace" * Section "SWD interface" updated.
0.00	74	090722	KN	Chapter "Introduction" * Section "Supported IDEs" added * Section "Supported CPU cores" updated * Section "Model comparison chart" renamed to "Model comparison" * Section "J-Link bundle comparison chart" removed
0.00	73	090701	KN	Chapter "Introduction" * Section "J-Link and J-Trace models" added * Sections "Model comparison chart" & "J-Link bundle comparison chart" added Chapter "J-Link and J-Trace models" removed Chapter "Hardware" renamed to "Target interfaces & adapters" * Section "JTAG Isolator" added Chapter "Target interfaces and adapters" * Section "Target board design" updated Several corrections
0.00	72	090618	AG	Chapter "Working with J-Link" * Section "J-Link control panel" updated. Chapter "Flash download and flash breakpoints" * Section "Supported devices" updated. Chapter "Device specifics" * Section "NXP" updated.
0.00	71	090616	AG	Chapter "Device specifics" * Section "NXP" updated.
0.00	70	090605	AG	Chapter "Introduction" * Section "Common features of the J-Link product family" updated.
0.00	69	090515	AG	Chapter "Working with J-Link" * Section "Reset strategies" updated. * Section "Indicators" updated. Chapter "Flash download and flash breakpoints" * Section "Supported devices" updated.
0.00	68	090428	AG	Chapter "J-Link and J-Trace related software" * Section "J-Link STM32 Commander" added. Chapter "Working with J-Link" * Section "Reset strategies" updated.
0.00	67	090402	AG	Chapter "Working with J-Link" * Section "Reset strategies" updated.
0.00	66	090327	AG	Chapter "Background information" * Section "Embedded Trace Macrocell (ETM)" updated. Chapter "J-Link and J-Trace related software" * Section "Dedicated flash programming utilities for J-Link" updated.
0.00	65	090320	AG	Several changes in the manual structure.
0.00	64	090313	AG	Chapter "Working with J-Link" * Section "Indicators" added.
0.00	63	090212	AG	Chapter "Hardware" * Several corrections. * Section "Hardware Versions" Version 8.0 added.
0.00	62	090211	AG	Chapter "Working with J-Link and J-Trace" * Section "Reset strategies" updated. Chapter "J-Link and J-Trace related software" * Section "J-Link STR91x Commander (Command line tool)" updated. Chapter "Device specifics" * Section "ST Microelectronics" updated. Chapter "Hardware" updated.
0.00	61	090120	TQ	Chapter "Working with J-Link" * Section "Cortex-M3 specific reset strategies"
0.00	60	090114	AG	Chapter "Working with J-Link"

Manual version	Revision	Date	By	Description
				* Section "Cortex-M3 specific reset strategies"
0.00	59	090108	KN	Chapter Hardware * Section "Target board design for JTAG" updated. * Section "Target board design for SWD" added.
0.00	58	090105	AG	Chapter "Working with J-Link Pro" * Section "Connecting J-Link Pro the first time" updated.
0.00	57	081222	AG	Chapter "Working with J-Link Pro" * Section "Introduction" updated. * Section "Configuring J-Link Pro via web interface" updated. Chapter "Introduction" * Section "J-Link Pro overview" updated.
0.00	56	081219	AG	Chapter "Working with J-Link Pro" * Section "FAQs" added. Chapter "Support and FAQs" * Section "Frequently Asked Questions" updated.
0.00	55	081218	AG	Chapter "Hardware" updated.
0.00	54	081217	AG	Chapter "Working with J-Link and J-Trace" * Section "J-Link Command Strings" updated.
0.00	53	081216	AG	Chapter "Working with J-Link Pro" updated.
0.00	52	081212	AG	Chapter "Working with J-Link Pro" added. Chapter "Licensing" * Section "Original SEGGER products" updated.
0.00	51	081202	KN	Several corrections.
0.00	50	081030	AG	Chapter "Flash download and flash breakpoints" * Section "Supported devices" corrected.
0.00	49	081029	AG	Several corrections.
0.00	48	080916	AG	Chapter "Working with J-Link and J-Trace" * Section "Connecting multiple J-Links / J-Traces to your PC" updated.
0.00	47	080910	AG	Chapter "Licensing" updated.
0.00	46	080904	AG	Chapter "Licensing" added. Chapter "Hardware" Section "J-Link OEM versions" moved to chapter "Licensing"
0.00	45	080902	AG	Chapter "Hardware" Section "JTAG+Trace connector" JTAG+Trace connector pinout corrected. Section "J-Link OEM versions" updated.
0.00	44	080827	AG	Chapter "J-Link control panel" moved to chapter "Working with J-Link". Several corrections.
0.00	43	080826	AG	Chapter "Flash download and flash breakpoints" Section "Supported devices" updated.
0.00	42	080820	AG	Chapter "Flash download and flash breakpoints" Section "Supported devices" updated.
0.00	41	080811	AG	Chapter "Flash download and flash breakpoints" updated. Chapter "Flash download and flash breakpoints", section "Supported devices" updated.
0.00	40	080630	AG	Chapter "Flash download and flash breakpoints" updated. Chapter "J-Link status window" renamed to "J-Link control panel" Various corrections.
0.00	39	080627	AG	Chapter "Flash download and flash breakpoints" Section "Licensing" updated. Section "Using flash download and flash breakpoints with different debuggers" updated. Chapter "J-Link status window" added.
0.00	38	080618	AG	Chapter "Support and FAQs" Section "Frequently Asked Questions" updated Chapter "Reset strategies" Section "Cortex-M3 specific reset strategies" updated.
0.00	37	080617	AG	Chapter "Reset strategies" Section "Cortex-M3 specific reset strategies" updated.

Manual version	Revision	Date	By	Description
0.00	36	080530	AG	Chapter "Hardware" Section "Differences between different versions" updated. Chapter "Working with J-Link and J-Trace" Section "Cortex-M3 specific reset strategies" added.
0.00	35	080215	AG	Chapter "J-Link and J-Trace related software" Section "J-Link software and documentation package in detail" updated.
0.00	34	080212	AG	Chapter "J-Link and J-Trace related software" Section "J-Link TCP/IP Server (Remote J-Link / J-Trace use)" updated. Chapter "Working with J-Link and J-Trace" Section "J-Link Command Strings" updated. Chapter "Flash download and flash breakpoints" Section "Introduction" updated. Section "Licensing" updated. Section "Using flash download and flash breakpoints with different debuggers" updated.
0.00	33	080207	AG	Chapter "Flash download and flash breakpoints" added Chapter "Device specifics": Section "ATMEL - AT91SAM7 - Recommended init sequence" added.
0.00	32	080129	SK	Chapter "Device specifics": Section "NXP - LPC - Fast GPIO bug" list of device enhanced.
0.00	31	080103	SK	Chapter "Device specifics": Section "NXP - LPC - Fast GPIO bug" updated.
0.00	30	071211	AG	Chapter "Device specifics": Section "Analog Devices" updated. Section "ATMEL" updated. Section "Freescale" added. Section "Luminary Micro" added. Section "NXP" updated. Section "OKI" added. Section "ST Microelectronics" updated. Section "Texas Instruments" updated. Chapter "Related software": Section "J-Link STR91x Commander" updated
0.00	29	070912	SK	Chapter "Hardware", section "Target board design" updated.
0.00	28	070912	SK	Chapter "Related software": Section "J-LinkSTR91x Commander" added. Chapter "Device specifics": Section "ST Microelectronics" added. Section "Texas Instruments" added. Subsection "AT91SAM9" added.
0.00	28	070912	AG	Chapter "Working with J-Link/J-Trace": Section "J-Link Command Strings" updated.
0.00	27	070827	TQ	Chapter "Working with J-Link/J-Trace": Section "J-Link Command Strings" updated.
0.00	26	070710	SK	Chapter "Introduction": Section "Features of J-Link" updated. Chapter "Background Information": Section "Embedded Trace Macrocell" added. Section "Embedded Trace Buffer" added.
0.00	25	070516	SK	Chapter "Working with J-Link/J-Trace": Section "Reset strategies in detail" - "Software, for Analog Devices ADuC7xxx MCUs" updated - "Software, for ATMEL AT91SAM7 MCUs" added. Chapter "Device specifics" Section "Analog Devices" added. Section "ATMEL" added.
0.00	24	070323	SK	Chapter "Setup": "Uninstalling the J-Link driver" updated. "Supported ARM cores" updated.
0.00	23	070320	SK	Chapter "Hardware": "Using the JTAG connector with SWD" updated.
0.00	22	070316	SK	Chapter "Hardware": "Using the JTAG connector with SWD" added.
0.00	21	070312	SK	Chapter "Hardware":

Manual version	Revision	Date	By	Description
				"Differences between different versions" supplemented.
0.00	20	070307	SK	Chapter "J-Link / J-Trace related software": "J-Link GDB Server" licensing updated.
0.00	19	070226	SK	Chapter "J-Link / J-Trace related software" updated and reorganized. Chapter "Hardware" "List of OEM products" updated
0.00	18	070221	SK	Chapter "Device specifics" added Subchapter "J-Link Command Strings" added
0.00	17	070131	SK	Chapter "Hardware": "Version 5.3": Current limits added "Version 5.4" added Chapter "Setup": "Installing the J-Link USB driver" removed. "Installing the J-Link software and documentation pack" added. Subchapter "List of OEM products" updated. "OS support" updated
0.00	16	061222	SK	Chapter "Preface": "Company description" added. J-Link picture changed.
0.00	15	060914	OO	Subchapter 1.5.1: Added target supply voltage and target supply current to specifications. Subchapter 5.2.1: Pictures of ways to connect J-Trace.
0.00	14	060818	TQ	Subchapter 4.7 "Using DCC for memory reads" added.
0.00	13	060711	OO	Subchapter 5.2.2: Corrected JTAG+Trace connector pinout table.
0.00	12	060628	OO	Subchapter 4.1: Added ARM966E-S to List of supported ARM cores.
0.00	11	060607	SK	Subchapter 5.5.2.2 changed. Subchapter 5.5.2.3 added.
0.00	10	060526	SK	ARM9 download speed updated. Subchapter 8.2.1: Screenshot "Start sequence" updated. Subchapter 8.2.2 "ID sequence" removed. Chapter "Support" and "FAQ" merged. Various improvements
0.00	9	060324	OO	Chapter "Literature and references" added. Chapter "Hardware": Added common information trace signals. Added timing diagram for trace. Chapter "Designing the target board for trace" added.
0.00	8	060117	OO	Chapter "Related Software": Added JLinkARM.dll. Screenshots updated.
0.00	7	051208	OO	Chapter Working with J-Link: Sketch added.
0.00	6	051118	OO	Chapter Working with J-Link: "Connecting multiple J-Links to your PC" added. Chapter Working with J-Link: "Multi core debugging" added. Chapter Background information: "J-Link firmware" added.
0.00	5	051103	TQ	Chapter Setup: "JTAG Speed" added.
0.00	4	051025	OO	Chapter Background information: "Flash programming" added. Chapter Setup: "Scan chain configuration" added. Some smaller changes.
0.00	3	051021	TQ	Performance values updated.
0.00	2	051011	TQ	Chapter "Working with J-Link" added.
0.00	1	050818	TW	Initial Version

About this document

Assumptions

This document assumes that you already have a solid knowledge of the following:

- The software tools used for building your application (assembler, linker, C compiler).
- The C programming language.
- The target processor.
- DOS command line.

If you feel that your knowledge of C is not sufficient, we recommend *The C Programming Language* by Kernighan and Richie (ISBN 0--13--1103628), which describes the standard in C programming and, in newer editions, also covers the ANSI C standard.

How to use this manual

This manual explains all the functions and macros that the product offers. It assumes you have a working knowledge of the C language. Knowledge of assembly programming is not required.

Typographic conventions for syntax

This manual uses the following typographic conventions:

Style	Used for
Body	Body text.
Keyword	Text that you enter at the command prompt or that appears on the display (that is system functions, file- or pathnames).
Parameter	Parameters in API functions.
Sample	Sample code in program examples.
Sample comment	Comments in program examples.
Reference	Reference to chapters, sections, tables and figures or other documents.
GUIElement	Buttons, dialog boxes, menu names, menu commands.
Emphasis	Very important sections.

Table of contents

1	Introduction	26
1.1	Requirements	27
1.2	Supported OS	28
1.3	Common features of the J-Link product family	29
1.4	Supported CPU cores	30
1.5	Built-in intelligence for supported CPU-cores	31
1.5.1	Intelligence in the J-Link firmware	31
1.5.2	Intelligence on the PC-side (DLL)	31
1.5.3	Firmware intelligence per model	32
1.6	Where to find further information	33
1.6.1	SEGGER debug probes	33
1.6.2	Using a feature in a specific development environment	33
2	Licensing	34
2.1	Components requiring a license	35
2.2	Legal use of SEGGER J-Link software	36
2.2.1	Use of the software with 3rd party tools	36
2.3	Illegal Clones	37
3	J-Link software and documentation package	38
3.1	Software overview	39
3.2	J-Link Commander (Command line tool)	40
3.2.1	Commands	40
3.2.2	Command line options	56
3.2.3	Using J-Link Command Files	59
3.3	J-Link Remote Server	61
3.3.1	List of available commands	61
3.3.2	Tunneling mode	62
3.4	J-Mem Memory Viewer	65
3.5	J-Flash	66
3.6	J-Flash Lite	67
3.6.1	Limitations in comparison to J-Flash	67
3.6.2	Usage	67
3.7	J-Link RTT Viewer	69
3.7.1	RTT Viewer Startup	69
3.7.2	Connection Settings	70
3.7.3	The Terminal Tabs	70
3.7.4	Sending Input	71
3.7.5	Logging Terminal output	71

3.7.6	Logging Data	71
3.7.7	Command line options	72
3.7.8	Menus and Shortcuts	74
3.7.9	Using "virtual" Terminals in RTT	76
3.7.10	Using Text Control Codes	76
3.8	J-Link SWO Viewer	77
3.8.1	J-Link SWO Viewer CL	77
3.8.2	Usage	78
3.8.3	List of available command line options	78
3.8.4	Configure SWO output after device reset	80
3.8.5	Target example code for terminal output	81
3.9	SWO Analyzer	83
3.10	JTAGLoad (Command line tool)	84
3.11	J-Link RDI (Remote Debug Interface)	86
3.11.1	Flash download and flash breakpoints	86
3.12	Processor specific tools	87
3.12.1	J-Link STR91x Commander (Command line tool)	87
3.12.2	J-Link STM32 Unlock (Command line tool)	90
3.13	J-Link Software Developer Kit (SDK)	93
4	J-Link GDB Server	94
4.1	J-Link GDB Server CL (Windows, Linux, Mac)	96
4.2	Debugging with J-Link GDB Server	97
4.2.1	Setting up GDB Server GUI version	97
4.2.2	Setting up GDB Server CL version	97
4.2.3	GDB Server user interface	98
4.2.4	Running GDB from different programs	99
4.3	Supported remote (monitor) commands	102
4.3.1	clrbp	103
4.3.2	cp15	104
4.3.3	device	104
4.3.4	DisableChecks	104
4.3.5	EnableChecks	105
4.3.6	flash breakpoints	105
4.3.7	flash erase	105
4.3.8	getargs	105
4.3.9	go	105
4.3.10	halt	106
4.3.11	interface	106
4.3.12	jtagconf	106
4.3.13	memU8	107
4.3.14	memU16	107
4.3.15	memU32	107
4.3.16	reg	108
4.3.17	regs	108
4.3.18	reset	108
4.3.19	semihosting breakOnError	109
4.3.20	semihosting enable	109
4.3.21	semihosting IOClient	109
4.3.22	semihosting ARMSWI	110
4.3.23	semihosting ThumbSWI	110
4.3.24	setargs	110
4.3.25	setbp	111
4.3.26	sleep	111
4.3.27	speed	111
4.3.28	step	112
4.3.29	SWO DisableTarget	112
4.3.30	SWO EnableTarget	112
4.3.31	SWO GetMaxSpeed	113

4.3.32	SWO GetSpeedInfo	113
4.3.33	waithalt	113
4.3.34	wice	114
4.3.35	ReadAP	114
4.3.36	ReadDP	114
4.3.37	WriteAP	115
4.3.38	WriteDP	115
4.4	SEGGER-specific GDB protocol extensions	117
4.5	Command line options	118
4.5.1	-cpu	119
4.5.2	-device	120
4.5.3	-endian	120
4.5.4	-gui	121
4.5.5	-if	121
4.5.6	-ir	121
4.5.7	-excdbg	121
4.5.8	-jtagconf	122
4.5.9	-localhostonly	122
4.5.10	-log	122
4.5.11	-logtofile	123
4.5.12	-halt	123
4.5.13	-nogui	123
4.5.14	-noir	123
4.5.15	-nolocalhostonly	124
4.5.16	-nologtofile	124
4.5.17	-nohalt	124
4.5.18	-noreset	125
4.5.19	-nosinglerun	125
4.5.20	-nosilent	125
4.5.21	-nostayontop	125
4.5.22	-notimeout	126
4.5.23	-novd	126
4.5.24	-port	126
4.5.25	-rtos	126
4.5.26	-JLinkDevicesXMLPath	127
4.5.27	-jlinkscriptfile	127
4.5.28	-powertarget	127
4.5.29	-select	127
4.5.30	-settingsfile	128
4.5.31	-silent	128
4.5.32	-singlerun	128
4.5.33	-speed	128
4.5.34	-stayontop	129
4.5.35	-timeout	129
4.5.36	-strict	129
4.5.37	-swoport	129
4.5.38	-telnetport	130
4.5.39	-vd	130
4.5.40	-x	130
4.5.41	-xc	131
4.6	Program termination	132
4.6.1	Exit codes	132
4.7	Semihosting	133
5	J-Mem	134
5.1	Setting up J-Mem	135
5.2	J-Mem user interface	136
5.2.1	Go To	136
5.2.2	Access width	136

5.2.3	Fill memory	136
5.2.4	Save memory data	137
5.2.5	Periodic Refresh	137
5.2.6	Command line options	138
6	Setup	139
6.1	Installing the J-Link software and documentation pack	140
6.1.1	Setup procedure	140
6.2	Setting up the USB interface	141
6.2.1	Verifying correct driver installation	141
6.2.2	Uninstalling the J-Link USB driver	142
6.3	Setting up the IP interface	144
6.3.1	Configuring J-Link using J-Link Configurator	144
6.3.2	Configuring J-Link using the webinterface	144
6.4	FAQs	146
6.5	J-Link Configurator	147
6.5.1	Configure J-Links using the J-Link Configurator	147
6.6	J-Link USB identification	149
6.6.1	Connecting to different J-Links connected to the same host PC via USB ...	149
6.7	Using the J-Link DLL	150
6.7.1	What is the JLink DLL?	150
6.7.2	Updating the DLL in third-party programs	150
6.7.3	Determining the version of JLink DLL	150
6.7.4	Determining which DLL is used by a program	151
7	Working with J-Link and J-Trace	152
7.1	Supported IDEs	153
7.2	Connecting the target system	154
7.2.1	Power-on sequence	154
7.2.2	Verifying target device connection	154
7.2.3	Problems	154
7.3	Indicators	155
7.3.1	Main indicator	155
7.3.2	Input indicator	155
7.3.3	Output indicator	156
7.4	JTAG interface	157
7.4.1	Multiple devices in the scan chain	157
7.4.2	Sample configuration dialog boxes	157
7.4.3	Determining values for scan chain configuration	159
7.4.4	JTAG Speed	160
7.5	SWD interface	161
7.5.1	SWD speed	161
7.5.2	SWO	161
7.6	Multi-core debugging	163
7.6.1	How multi-core debugging works	163
7.6.2	Using multi-core debugging in detail	164
7.6.3	Things you should be aware of	165
7.7	Connecting multiple J-Links / J-Traces to your PC	166
7.7.1	How does it work?	166
7.8	J-Link control panel	168
7.8.1	Tabs	168
7.9	Reset strategies	174
7.9.1	Strategies for ARM 7/9 devices	174
7.9.2	Strategies for Cortex-M devices	175
7.10	Using DCC for memory access	179
7.10.1	What is required?	179
7.10.2	Target DCC handler	179
7.10.3	Target DCC abort handler	179
7.11	The J-Link settings file	180

7.11.1	SEgger Embedded Studio	180
7.11.2	Keil MDK-ARM (uVision)	180
7.11.3	IAR EWARM	180
7.11.4	Mentor Sourcery CodeBench for ARM	180
7.12	J-Link script files	181
7.12.1	Actions that can be customized	181
7.12.2	Script file API functions	188
7.12.3	Global DLL variables	211
7.12.4	Global DLL constants	215
7.12.5	Script file language	217
7.12.6	Script file writing example	218
7.12.7	Executing J-Link script files	219
7.13	J-Link Command Strings	220
7.13.1	List of available commands	220
7.13.2	Using J-Link Command Strings	243
7.14	Switching off CPU clock during debug	244
7.15	Cache handling	245
7.15.1	Cache coherency	245
7.15.2	Cache clean area	245
7.15.3	Cache handling of ARM7 cores	245
7.15.4	Cache handling of ARM9 cores	245
7.16	Virtual COM Port (VCOM)	246
7.16.1	Configuring Virtual COM Port	246
8	Flash download	248
8.1	Introduction	249
8.2	Licensing	250
8.3	Supported devices	251
8.4	Setup for various debuggers (internal flash)	252
8.5	Setup for various debuggers (CFI flash)	253
8.6	Setup for various debuggers (SPIFI flash)	254
8.7	QSPI flash support	255
8.7.1	Setup the DLL for QSPI flash download	255
8.8	Using the DLL flash loaders in custom applications	256
8.9	Debugging applications that change flash contents at runtime	257
9	Flash breakpoints	258
9.1	Introduction	259
9.2	Licensing	260
9.2.1	Free for evaluation and non-commercial use	260
9.3	Supported devices	261
9.4	Setup & compatibility with various debuggers	262
9.4.1	Setup	262
9.4.2	Compatibility with various debuggers	262
9.5	Flash Breakpoints in QSPI flash	263
9.5.1	Setup	263
9.6	FAQ	264
10	Monitor Mode Debugging	265
10.1	Introduction	266
10.2	Enable Monitor Debugging	267
10.3	Availability and limitations of monitor mode	268
10.3.1	Cortex-M3	268
10.3.2	Cortex-M4	268
10.4	Monitor code	269
10.5	Debugging interrupts	270
10.6	Having servicing interrupts in debug mode	271
10.7	Forwarding of Monitor Interrupts	272

10.8	Target application performs reset (Cortex-M)	273
11	Low Power Debugging	274
11.1	Introduction	275
11.2	Activating low power mode handling for J-Link	276
11.3	Restrictions	277
12	Open Flashloader	278
12.1	Introduction	279
12.2	General procedure	280
12.3	Adding a new device	281
12.4	Editing/Extending an Existing Device	282
12.5	XML Tags and Attributes	283
12.5.1	<Database>	283
12.5.2	<Device>	283
12.5.3	<ChipInfo>	283
12.5.4	<FlashBankInfo>	285
12.6	Example XML file	287
12.7	Add. Info / Considerations / Limitations	288
12.7.1	CMSIS Flash Algorithms Compatibility	288
12.7.2	Supported Cores	288
12.7.3	Information for Silicon Vendors	288
12.7.4	Template Projects and How To's	288
13	J-Flash SPI	289
13.1	Introduction	290
13.1.1	What is J-Flash SPI?	290
13.1.2	J-Flash SPI CL (Windows, Linux, Mac)	290
13.1.3	Features	291
13.1.4	Requirements	291
13.2	Licensing	292
13.2.1	Introduction	292
13.3	Getting Started	293
13.3.1	Setup	293
13.3.2	Using J-Flash SPI for the first time	293
13.3.3	Menu structure	294
13.4	Settings	297
13.4.1	Project Settings	297
13.4.2	Global Settings	301
13.5	Command Line Interface	303
13.5.1	Overview	303
13.5.2	Command line options	303
13.5.3	Batch processing	305
13.5.4	Programming multiple targets in parallel	305
13.6	Creating a new J-Flash SPI project	308
13.7	Custom Command Sequences	309
13.7.1	Init / Exit steps	309
13.7.2	Example	309
13.7.3	J-Flash SPI Command Line Version	310
13.8	Device specifics	313
13.8.1	SPI flashes with multiple erase commands	313
13.9	Target systems	314
13.9.1	Which flash devices can be programmed?	314
13.10	Performance	315
13.10.1	Performance values	315
13.11	Background information	316
13.11.1	SPI interface connection	316
13.12	Support	317

13.12.1	Troubleshooting	317
13.12.2	Contacting support	317
14	RDI	318
14.1	Introduction	319
14.1.1	Features	319
14.2	Licensing	320
14.3	Setup for various debuggers	321
14.3.1	ARM AXD (ARM Developer Suite, ADS)	321
14.3.2	ARM RVDS (RealView developer suite)	323
14.3.3	GHS MULTI	328
14.4	Configuration	331
14.4.1	Configuration file JLinkRDI.ini	331
14.4.2	Using different configurations	331
14.4.3	Using multiple J-Links simultaneously	331
14.4.4	Configuration dialog	331
14.5	Semihosting	340
14.5.1	Unexpected / unhandled SWIs	340
15	ARM SWD specifics	341
15.1	Introduction	342
15.2	SWD multi-drop	343
15.2.1	How it works	343
15.2.2	Setting up SWD multi-drop in the J-Link software	343
15.2.3	J-Link support	343
16	RTT	344
16.1	Introduction	345
16.2	How RTT works	346
16.2.1	Target implementation	346
16.2.2	Locating the Control Block	346
16.2.3	Internal structures	346
16.2.4	Requirements	347
16.2.5	Performance	347
16.2.6	Memory footprint	347
16.3	RTT Communication	348
16.3.1	RTT Viewer	348
16.3.2	RTT Client	348
16.3.3	RTT Logger	348
16.3.4	RTT in other host applications	349
16.4	Implementation	350
16.4.1	API functions	350
16.4.2	Configuration defines	356
16.5	ARM Cortex - Background memory access	358
16.6	Example code	359
16.7	FAQ	360
17	Trace	361
17.1	Introduction	362
17.1.1	What is backtrace?	362
17.1.2	What is streaming trace?	362
17.1.3	What is code coverage?	362
17.1.4	What is code profiling?	363
17.2	Tracing via trace pins	364
17.2.1	Cortex-M specifics	364
17.2.2	Trace signal timing	364
17.2.3	Adjusting trace signal timing on J-Trace	364
17.2.4	J-Trace models with support for streaming trace	365

17.3	Tracing with on-chip trace buffer	366
17.3.1	CPUs that provide tracing via pins and on-chip buffer	366
17.4	Target devices with trace support	367
17.5	Streaming trace	368
17.5.1	Download and execution address differ	368
17.5.2	Do streaming trace without prior download	368
18	Target interfaces and adapters	369
18.1	20-pin J-Link connector	370
18.1.1	Pinout for JTAG	370
18.1.2	Pinout for SWD	372
18.1.3	Pinout for SWD + Virtual COM Port (VCOM)	374
18.1.4	Pinout for SPI	375
18.2	19-pin JTAG/SWD and Trace connector	376
18.2.1	Connecting the target board	377
18.2.2	Target power supply	377
18.3	9-pin JTAG/SWD connector	379
18.4	Reference voltage (VTref)	380
18.5	Adapters	381
19	Background information	382
19.1	JTAG	383
19.1.1	Test access port (TAP)	383
19.1.2	Data registers	383
19.1.3	Instruction register	383
19.1.4	The TAP controller	383
19.2	Embedded Trace Macrocell (ETM)	386
19.2.1	Trigger condition	386
19.2.2	Code tracing and data tracing	386
19.2.3	J-Trace integration example - IAR Embedded Workbench for ARM	386
19.3	Embedded Trace Buffer (ETB)	390
19.4	Flash programming	391
19.4.1	How does flash programming via J-Link / J-Trace work?	391
19.4.2	Data download to RAM	391
19.4.3	Data download via DCC	391
19.4.4	Available options for flash programming	391
19.5	J-Link / J-Trace firmware	393
19.5.1	Firmware update	393
19.5.2	Invalidating the firmware	393
20	Designing the target board for trace	395
20.1	Overview of high-speed board design	396
20.1.1	Avoiding stubs	396
20.1.2	Minimizing Signal Skew (Balancing PCB Track Lengths)	396
20.1.3	Minimizing Crosstalk	396
20.1.4	Using impedance matching and termination	396
20.2	Terminating the trace signal	397
20.2.1	Rules for series terminators	397
20.3	Signal requirements	398
21	Semihosting	399
21.1	Introduction	400
21.1.1	Advantages	400
21.1.2	Disadvantages	400
21.2	Debugger support	401
21.3	Implementation	402
21.3.1	SVC instruction	402
21.3.2	Breakpoint instruction	402

21.3.3	J-Link GDBServer optimized version	402
21.4	Communication protocol	405
21.4.1	Register R0	405
21.4.2	Command SYS_OPEN (0x01)	405
21.4.3	Command SYS_CLOSE (0x02)	406
21.4.4	Command SYS_WRITEC (0x03)	406
21.4.5	Command SYS_WRITE0 (0x04)	407
21.4.6	Command SYS_WRITE (0x05)	407
21.4.7	Command SYS_READ (0x06)	407
21.4.8	Command SYS_READC (0x07)	408
21.4.9	Command SYS_ISTTY (0x09)	408
21.4.10	Command SYS_SEEK (0x0A)	408
21.4.11	Command SYS_FLEN (0x0C)	409
21.4.12	Command SYS_REMOVE (0x0E)	409
21.4.13	Command SYS_RENAME (0x0F)	409
21.4.14	Command SYS_GET_CMDLINE (0x15)	410
21.4.15	Command SYS_EXIT (0x18)	410
21.5	Enabling semihosting in J-Link GDBServer	411
21.5.1	SVC variant	411
21.5.2	Breakpoint variant	411
21.5.3	J-Link GDBServer optimized variant	411
21.6	Enabling Semihosting in J-Link RDI + AXD	412
21.6.1	Using SWIs in your application	412
22	Environmental Conditions & Safety	413
22.1	J-Link	414
22.1.1	Affected models	414
22.2	Flasher	415
22.2.1	Affected models	415
22.3	J-Trace	416
22.3.1	Affected models	416
23	Support and FAQs	417
23.1	Measuring download speed	418
23.2	Troubleshooting	419
23.2.1	General procedure	419
23.3	Contacting support	420
23.3.1	Contact Information	420

Chapter 1

Introduction

This is the user documentation for owners of SEGGER debug probes, J-Link and J-Trace. This manual documents the software which with the J-Link Software and Documentation Package as well as advanced features of J-Link and J-Trace, like Real Time Transfer ([RTT](#)), [J-Link Script Files](#) or [Trace](#).

1.1 Requirements

Host System

To use J-Link or J-Trace you need a host system running Windows 2000 or later. For a list of all operating systems which are supported by J-Link, please refer to *Supported OS* on page 28.

Target System

A target system with a supported CPU is required. You should make sure that the emulator you are looking at supports your target CPU. For more information about which J-Link features are supported by each emulator, please refer to *SEGGER debug probes* on page 33.

1.2 Supported OS

J-Link/J-Trace can be used on the following operating systems:

- Microsoft Windows 2000
- Microsoft Windows XP
- Microsoft Windows XP x64
- Microsoft Windows 2003
- Microsoft Windows 2003 x64
- Microsoft Windows Vista
- Microsoft Windows Vista x64
- Microsoft Windows 7
- Microsoft Windows 7 x64
- Microsoft Windows 8
- Microsoft Windows 8 x64
- Microsoft Windows 10
- Microsoft Windows 10 x64
- Linux
- macOS 10.5 and higher

1.3 Common features of the J-Link product family

- USB 2.0 interface (Full-Speed/Hi-Speed, depends on J-Link model)
- Any ARM7/ARM9/ARM11 (including thumb mode), Cortex-A5/A7/A8/A9/A12/A15/A17, Cortex-M0/M1/M3/M4/M7/M23/M33, Cortex-R4/R5 core supported
- Automatic core recognition
- Maximum interface speed 15/50 MHz (depends on J-Link model)
- Seamless integration into all major IDEs ([List of supported IDEs](#))
- No power supply required, powered through USB
- Support for adaptive clocking
- All JTAG signals can be monitored, target voltage can be measured
- Support for multiple devices
- Fully plug and play compatible
- Standard 20-pin JTAG/SWD connector, 19-pin JTAG/SWD and Trace connector, standard 38-pin JTAG+Trace connector
- USB and 20-pin ribbon cable included
- Memory viewer (J-Mem) included
- Remote server included, which allows using J-Trace via TCP/IP networks
- RDI interface available, which allows using J-Link with RDI compliant software
- Flash programming software (J-Flash) available
- Flash DLL available, which allows using flash functionality in custom applications
- Software Developer Kit (SDK) available
- 14-pin JTAG adapter available
- J-Link 19-pin Cortex-M Adapter available
- J-Link 9-pin Cortex-M Adapter available
- Adapter for 5V JTAG targets available for hardware revisions up to 5.3
- Optical isolation adapter for JTAG/SWD interface available
- Target power supply via pin 19 of the JTAG/SWD interface (up to 300 mA to target with overload protection), alternatively on pins 11 and 13 of the Cortex-M 19-pin trace connector

1.4 Supported CPU cores

J-Link / J-Trace supports any common ARM Cortex core, ARM legacy core, Microchip PIC32 core and Renesas RX core. For a detailed list, please refer to:

[SEgger website: Supported Cores](#) .

If you experience problems with a particular core, do not hesitate to contact SEGGER.

1.5 Built-in intelligence for supported CPU-cores

In general, there are two ways to support a CPU-core in the J-Link software:

1. Intelligence in the J-Link firmware
2. Intelligence on the PC-side (DLL)

Having the intelligence in the firmware is ideal since it is much more powerful and robust. The J-Link PC software automatically detects which implementation level is supported for the connected CPU-core. If intelligence in the firmware is available, it is used. If you are using a J-Link that does not have intelligence in the firmware and only PC-side intelligence is available for the connected CPU, a warning message is shown.

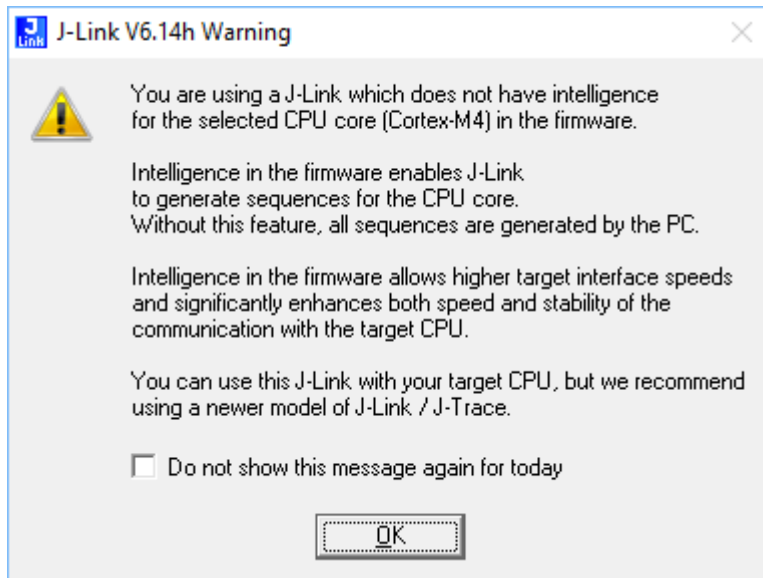

1.5.1 Intelligence in the J-Link firmware

On newer J-Links, the intelligence for a new CPU-core is also available in the J-Link firmware which means that for these J-Links, the target sequences are no longer generated on the PC-side but directly inside the J-Link. Having the intelligence in the firmware leads to improved stability and higher performance.

1.5.2 Intelligence on the PC-side (DLL)

This is the basic implementation level for support of a CPU-core. This implementation is not J-Link model dependent, since no intelligence for the CPU-core is necessary in the J-Link firmware. This means, all target sequences (JTAG/SWD/...) are generated on the PC-side and the J-Link simply sends out these sequences and sends the result back to the DLL. Using this way of implementation also allows old J-Links to be used with new CPU cores as long as a DLL-Version is used which has intelligence for the CPU.

But there is one big disadvantage of implementing the CPU core support on the DLL-side: For every sequence which shall be sent to the target a USB or Ethernet transaction is triggered. The long latency especially on a USB connection significantly affects the performance of J-Link. This is true especially when performing actions where J-Link has to wait for the CPU frequently. An example is a memory read/write operation which needs to be followed by status read operations or repeated until the memory operation is completed. Performing this kind of task with only PC-side intelligence requires to either make some assumption like: Operation is completed after a given number of cycles. Or it requires to make a lot of USB/Ethernet transactions. The first option (fast mode) will not work under some circumstances such as low CPU speeds, the second (slow mode) will be more reliable but very slow due to the high number of USB/Ethernet transactions. It simply boils down to: The best solution is having intelligence in the emulator itself!

1.5.2.1 Limitations of PC-side implementations

- **Instability, especially on slow targets**
Due to the fact that a lot of USB transactions would cause a very bad performance of J-Link, PC-side implementations are on the assumption that the CPU/Debug interface is fast enough to handle the commands/requests without the need of waiting. So, when using the PC-side-intelligence, stability cannot be guaranteed in all cases, especially if the target interface speed (JTAG/SWD/...) is significantly higher than the CPU speed.
- **Poor performance**
Since a lot more data has to be transferred over the host interface (typically USB), the resulting download speed is typically much lower than for implementations with intelligence in the firmware, even if the number of transactions over the host interface is limited to a minimum (fast mode).
- **No support**
Please understand that we cannot give any support if you are running into problems when using a PC-side implementation.

Note

Due to these limitations, we recommend to use PC-side implementations for evaluation only.

1.5.3 Firmware intelligence per model

There are different models of J-Link / J-Trace which have built-in intelligence for different CPU-cores. Please refer to *J-Link / J-Trace hardware revisions* for further information.

1.6 Where to find further information

The following items are not the scope of the J-Link / J-Trace User Guide (UM08001) and therefore documented elsewhere in the respective place described/listed below.

1.6.1 SEGGER debug probes

1.6.1.1 J-Link / J-Trace current model overview

In order to compare features, performance specifications, capabilities and included licenses of current J-Link / J-Trace or Flasher models, please refer to the SEGGER website:

[J-Link Model overview](#)

1.6.1.2 J-Link / J-Trace hardware revisions

For feature comparisons between different hardware revisions of J-Link / J-Trace or Flasher models, please refer to:

[SEGGER Wiki: J-Link / J-Trace / Flasher Software and Hardware features overview](#)

1.6.1.3 J-Link / J-Trace hardware specifications

For detailed general, mechanical and electrical specifications of a specific J-Link / J-Trace or Flasher model, please refer to:

[SEGGER Wiki: J-Link / J-Trace / Flasher general, mechanical, electrical specifications](#)

1.6.2 Using a feature in a specific development environment

For many features described in this manual, detailed explanations on how to use them with popular debuggers, IDEs and other applications are available in the SEGGER wiki. Therefore, for information on how to use a feature in a specific development environment, please refer to:

[SEGGER Wiki: Getting Started with Various IDEs](#) .

If an explanation is missing for the IDE used or the IDE used is not listed at all, please contact us. (see [Contact Information](#))

Chapter 2

Licensing

This chapter describes the different license types of J-Link related software and the legal use of the J-Link software with original SEGGER and OEM products.

2.1 Components requiring a license

J-Link PLUS and higher are fully featured J-Links and come with all licenses included. Other models may do not come with all features enabled. For a detailed overview of the included licenses of the SEGGER debug probes, please refer to:

[J-Link Model overview: Licenses](#)

2.2 Legal use of SEGGER J-Link software

The software consists of proprietary programs of SEGGER, protected under copyright and trade secret laws. All rights, title and interest in the software are and shall remain with SEGGER. For details, please refer to the license agreement which needs to be accepted when installing the software. The text of the license agreement is also available as entry in the start menu after installing the software.

Use of software

SEGGER J-Link software may only be used with original SEGGER products and authorized OEM products. The use of the licensed software to operate SEGGER product clones is prohibited and illegal.

2.2.1 Use of the software with 3rd party tools

For simplicity, some components of the J-Link software are also distributed by partners with software tools designed to use J-Link. These tools are primarily debugging tools, but also memory viewers, flash programming utilities as well as software for other purposes. Distribution of the software components is legal for our partners, but the same rules as described above apply for their usage: They may only be used with original SEGGER products and authorized OEM products. The use of the licensed software to operate SEGGER product clones is prohibited and illegal.

2.3 Illegal Clones

Clones are copies of SEGGER products which use the copyrighted SEGGER Firmware without a license. It is strictly prohibited to use SEGGER J-Link software with illegal clones of SEGGER products. Manufacturing and selling these clones is an illegal act for various reasons, amongst them trademark, copyright and unfair business practice issues. The use of illegal J-Link clones with this software is a violation of US, European and other international laws and is prohibited. If you are in doubt if your unit may be legally used with SEGGER J-Link software, please get in touch with us. End users may be liable for illegal use of J-Link software with clones.

Chapter 3

J-Link software and documentation package

This chapter describes the contents of the J-Link Software and Documentation Package which can be downloaded from www.segger.com.

3.1 Software overview

The J-Link Software and Documentation Package, which is available for download from segger.com/jlink-software.html, includes some applications to be used with J-Link. It also comes with USB-drivers for J-Link and documentations in pdf format.

Software	Description
J-Link Commander	Command-line tool with basic functionality for target analysis.
J-Link GDB Server	The J-Link GDB Server is a server connecting to the GNU Debugger (GDB) via TCP/IP. It is required for toolchains using the GDB protocol to connect to J-Link.
J-Link GDB Server command line version	Command line version of the J-Link GDB Server. Same functionality as the GUI version.
J-Link Remote Server	Utility which provides the possibility to use J-Link / J-Trace remotely via TCP/IP.
J-Mem	Target memory viewer. Shows the memory content of a running target and allows editing as well.
J-Flash ^a	Stand-alone flash programming application. For more information about J-Flash please refer to J-Flash ARM User's Guide (UM08003).
J-Flash Lite	Stand-alone flash programming application. Reduced feature set of J-Flash
J-Link RTT Viewer	Free-of-charge utility for J-Link. Displays the terminal output of the target using RTT . Can be used in parallel with a debugger or stand-alone.
J-Link SWO Viewer	Free-of-charge utility for J-Link. Displays the terminal output of the target using the SWO pin. Can be used in parallel with a debugger or stand-alone.
J-Link SWO Analyzer	Command line tool that analyzes SWO RAW output and stores it into a file.
JTAGLoad	Command line tool that opens an svf file and sends the data in it via J-Link / J-Trace to the target.
J-Link Configurator	GUI-based configuration tool for J-Link. Allows configuration of USB identification as well as TCP/IP identification of J-Link. For more information about the J-Link Configurator, please refer to <i>J-Link Configurator</i> .
RDI support ^a	Provides Remote Debug Interface (RDI) support. This allows the user to use J-Link with any RDI-compliant debugger.
Processor specific tools	Free command-line tools for handling specific processors. Included are: STR9 Commander and STM32 Unlock.

^a Full-featured J-Link (PLUS, PRO, ULTRA+) or an additional license for J-Link base model required.

3.2 J-Link Commander (Command line tool)

J-Link Commander (`JLink.exe`) is a tool that can be used for verifying proper installation of the USB driver and to verify the connection to the target CPU, as well as for simple analysis of the target system. It permits some simple commands, such as memory dump, halt, step, go etc. to verify the target connection.

```

J-Link V6.14h
SEGGER J-Link Commander V6.14h (Compiled May 10 2017 18:23:19)
DLL version V6.14h, compiled May 10 2017 18:22:45

Connecting to J-Link via USB...O.K.
Firmware: J-Link Pro V4 compiled Apr 21 2017 11:15:52
Hardware version: V4.00
S/N: 174402383
License(s): RDI, FlashBP, FlashDL, JFlash, GDB
IP-Addr: DHCP (no addr. received yet)
VTref = 3.301V

Type "connect" to establish a target connection, '?' for help
J-Link>si 0
Selecting JTAG as current target interface.
J-Link>speed 4000
Selecting 4000 kHz as target interface speed
J-Link>device stm32f407ve
J-Link>con
Device position in JTAG chain (IRPre,DRPre) <Default>: -1,-1 => Auto-detect
JTAGConf>
Device "STM32F407VE" selected.

TotalIRLen = 9, IRPrint = 0x0011
TotalIRLen = 9, IRPrint = 0x0011
No AP preselected. Assuming that AP[0] is the AHB-AP
AP-IDR: 0x24770011, Type: AHB-AP
AHB-AP ROM: 0xE00FF000 (Base addr. of first ROM table)
Found Cortex-M4 r0p1, Little endian.
FPUnit: 6 code (BP) slots and 2 literal slots
CoreSight components:
ROMTbl[0] @ E00FF000
ROMTbl[0][0]: E00E000, CID: B105E00D, PID: 000BB00C SCS
ROMTbl[0][1]: E001000, CID: B105E00D, PID: 003BB002 DWT
ROMTbl[0][2]: E002000, CID: B105E00D, PID: 002BB003 FPB
ROMTbl[0][3]: E000000, CID: B105E00D, PID: 003BB001 ITM
ROMTbl[0][4]: E004000, CID: B105900D, PID: 000BB9A1 TPIU
ROMTbl[0][5]: E0041000, CID: B105900D, PID: 000BB925 ETM
Found 2 JTAG devices, Total IRLen = 9:
#0 Id: 0x4BA00477, IRLen: 04, IRPrint: 0x1, CoreSight JTAG-DP (ARM)
#1 Id: 0x06413041, IRLen: 05, IRPrint: 0x1, STM32 Boundary Scan
Cortex-M4 identified.
J-Link>

```

J-Link Commander: JTAG connection

3.2.1 Commands

The table below lists the available commands of J-Link Commander. All commands are listed in alphabetical order within their respective categories. Detailed descriptions of the commands can be found in the sections that follow.

Command (short form)	Explanation
Basic	
<code>clrBP</code>	Clear breakpoint.
<code>clrWP</code>	Clear watchpoint.
<code>device</code>	Selects a device.
<code>erase</code>	Erase internal flash of selected device.
<code>exec</code>	Execute J-Link Command String.
<code>exit (qc, q)</code>	Closes J-Link Commander.
<code>exitonerror (eoe)</code>	Commander exits after error.
<code>f</code>	Prints firmware info.
<code>go (g)</code>	Starts the CPU core.
<code>halt (h)</code>	Halts the CPU core.
<code>hwinfo</code>	Show hardware info.
<code>is</code>	Scan chain select register length.
<code>loadfile</code>	Load data file into target memory.

Command (short form)	Explanation
log	Enables log to file.
mem	Read memory.
mem8	Read 8-bit items.
mem16	Read 16-bit items.
mem32	Read 32-bit items.
mem64	Read 64-bit items.
mr	Measures reaction time of RTCK pin.
ms	Measures length of scan chain.
power	Switch power supply for target.
r	Resets and halts the target.
readAP	Reads from a CoreSight AP register.
readDP	Reads from a CoreSight DP register.
regs	Shows all current register values.
rnh	Resets without halting the target.
rreg	Shows a specific register value.
rx	Reset target with delay.
savebin	Saves target memory into binary file.
setBP	Set breakpoint.
setPC	Set the PC to specified value.
setWP	Set watchpoint.
sleep	Waits the given time (in milliseconds).
speed	Set target interface speed.
st	Shows the current hardware status.
step (s)	Single step the target chip.
unlock	Unlocks a device.
verifybin	Compares memory with data file.
w1	Write 8-bit items.
w2	Write 16-bit items.
w4	Write 32-bit items.
writeAP	Writes to a CoreSight AP register.
writeDP	Writes to a CoreSight DP register.
wreg	Write register.
Flasher I/O	
fdelete (fdel)	Delete file on emulator.
flist	List directory on emulator.
fread (frd)	Read file from emulator.
fshow	Read and display file from emulator.
fsize (fsz)	Display size of file on emulator.
fwrite (fwr)	Write file to emulator.
Connection	
ip	Connect to J-Link Pro via TCP/IP.
usb	Connect to J-Link via USB.
Configuration	

Command (short form)	Explanation
VTREF	Sets a fixed value for VTref on J-Link.

3.2.1.1 clrBP

This command removes a breakpoint set by J-Link.

Syntax

```
clrBP <BP_Handle>
```

Parameter	Meaning
BP_Handle	Handle of breakpoint to be removed.

Example

```
clrBP 1
```

3.2.1.2 clrWP

This command removes a watchpoint set by J-Link.

Syntax

```
clrWP <WP_Handle>
```

Parameter	Meaning
WP_Handle	Handle of watchpoint to be removed.

Example

```
clrWP 0x2
```

3.2.1.3 device

Selects a specific device J-Link shall connect to and performs a reconnect. In most cases explicit selection of the device is not necessary. Selecting a device enables the user to make use of the J-Link flash programming functionality as well as using unlimited breakpoints in flash memory. For some devices explicit device selection is mandatory in order to allow the DLL to perform special handling needed by the device. Some commands require that a device is set prior to use them.

Syntax

```
device <DeviceName>
```

Parameter	Meaning
DeviceName	Valid device name: Device is selected. ?: Shows a device selection dialog.

Example

```
device stm32f407ig
```

3.2.1.4 erase

Erases all flash sectors of the current device. A device has to be specified previously.

Syntax

```
erase
```

3.2.1.5 exec

Execute J-Link Command String. For more information about the usage of J-Link Command Strings please refer to *J-Link Command Strings* .

Syntax

```
exec <Command>
```

Parameter	Meaning
Command	J-Link Command String to be executed.

Example

```
exec SupplyPower = 1
```

3.2.1.6 exit

This command closes the target connection, the connection to the J-Link and exits J-Link Commander.

Syntax

```
q
```

3.2.1.7 exitonerror

This command toggles whether J-Link Commander exits on error or not.

Syntax

```
ExitOnError <1|0>
```

Parameter	Meaning
<1 0>	1: J-Link Commander will now exit on Error. 0: J-Link Commander will no longer exit on Error.

Example

```
ee 1
```

3.2.1.8 f

Prints firmware and hardware version info. Please notice that minor hardware revisions may not be displayed, as they do not have any effect on the feature set.

Syntax

```
f
```

3.2.1.9 fdelete

On emulators which support file I/O this command deletes a specific file.

Syntax

```
fdelete <FileName>
```

Parameter	Meaning
FileName	File to delete from the Flasher.

Example

```
fdelete Flasher.dat
```

3.2.1.10 flist

On emulators which support file I/O this command shows the directory tree of the Flasher.

Syntax

```
flist
```

3.2.1.11 fread

On emulators which support file I/O this command reads a specific file. Offset applies to both destination and source file.

Syntax

```
fread <EmuFile> <HostFile> [<Offset> [<NumBytes>]]
```

Parameter	Meaning
EmuFile	File name to read from.
HostFile	Destination file on the host.
Offset	Specifies the offset in the file, at which data reading is started.
NumBytes	Maximum number of bytes to read.

Example

```
fread Flasher.dat C:\Project\Flasher.dat
```

3.2.1.12 fshow

On emulators which support file I/O this command reads and prints a specific file. Currently, only Flasher models support file I/O.

Syntax

```
fshow <FileName> [-a] [<Offset> [<NumBytes>]]
```

Parameter	Meaning
FileName	Source file name to read from the Flasher.
a	If set, Input will be parsed as text instead of being shown as hex.
Offset	Specifies the offset in the file, at which data reading is started.
NumBytes	Maximum number of bytes to read.

Example

```
fshow Flasher.dat
```

3.2.1.13 fsize

On emulators which support file I/O this command gets the size of a specific file. Currently, only Flasher models support file I/O.

Syntax

```
fsize <FileName>]
```

Parameter	Meaning
FileName	Source file name to read from the Flasher.

Example

```
fsize Flasher.dat
```

3.2.1.14 fwrite

On emulators which support file I/O this command writes a specific file. Currently, only Flasher models support file I/O. NumBytes is limited to 512 bytes at once. This means, if you want to write e.g. 1024 bytes, you have to send the command twice, using an appropriate offset when sending it the second time. Offset applies to both destination and source file.

Syntax

```
fwrite <EmuFile> <HostFile> [<Offset> [<NumBytes>]]
```

Parameter	Meaning
<code>EmuFile</code>	File name to write to.
<code>HostFile</code>	Source file on the host
<code>Offset</code>	Specifies the offset in the file, at which data writing is started.
<code>NumBytes</code>	Maximum number of bytes to write.

Example

```
fwrite Flasher.dat C:\Project\Flasher.dat
```

3.2.1.15 go

Starts the CPU. In order to avoid setting breakpoints it allows to define a maximum number of instructions which can be simulated/emulated. This is particularly useful when the program is located in flash and flash breakpoints are used. Simulating instructions avoids to reprogram the flash and speeds up (single) stepping.

Syntax

Syntax

```
go [<NumSteps> [<Flags>]]
```

Parameter	Meaning
<code>NumSteps</code>	Maximum number of instructions allowed to be simulated. Instruction simulation stops whenever a breakpointed instruction is hit, an instruction which cannot be simulated/emulated is hit or when NumSteps is reached.
<code>Flags</code>	0: Do not start the CPU if a BP is in range of NumSteps 1: Overstep BPs

Example

```
go //Simply starts the CPU
go 20, 1
```

3.2.1.16 halt

Halts the CPU Core. If successful, shows the current CPU registers.

Syntax

```
halt
```

3.2.1.17 hwinfo

This command can be used to get information about the power consumption of the target (if the target is powered via J-Link). It also gives the information if an overcurrent happened.

Syntax

```
hwinfo
```

3.2.1.18 ip

Closes any existing connection to J-Link and opens a new one via TCP/IP. If no IP Address is specified, the Emulator selection dialog shows up.

Syntax

```
ip [<Addr>]
```

Parameter	Meaning
Addr	Valid values: IP Address: Connects the J-Link with the specified IP-Address Host Name: Resolves the host name and connects to it. *: Invokes the Emulator selection dialog.

Example

```
ip 192.168.6.3
```

3.2.1.19 is

This command returns information about the length of the scan chain select register.

Syntax

```
is
```

3.2.1.20 loadfile

This command programs a given data file to a specified destination address. Currently supported data files are:

- *.mot
- *.srec
- *.s19
- *.s
- *.hex
- *.bin

Syntax

```
loadfile <Filename> [<Addr>]
```

Parameter	Meaning
Filename	Source filename
Addr	Destination address (Required for *.bin files)

Example

```
loadfile C:\Work\test.bin 0x20000000
```

3.2.1.21 log

Set path to logfile allowing the DLL to output logging information. If the logfile already exists, the contents of the current logfile will be overwritten.

Syntax

```
log <Filename>
```

Parameter	Meaning
Filename	Log filename

Example

```
log C:\Work\log.txt
```

3.2.1.22 mem

The command reads memory from the target system. If necessary, the target CPU is halted in order to read memory. Zone names will be displayed on first connect to target with J-Link commander if available.

Syntax

```
mem [<Zone>:]<Addr>, <NumBytes> (hex)
```

Parameter	Meaning
Zone	Name of memory zone to access.
Addr	Start address.
Numbytes	Number of bytes to read. Maximum is 0x100000.

Example

```
mem 0x0, 0x100
```

or

```
mem AHB-AP (AP1):0x20000000, 0x100
```

3.2.1.23 mem8

The command reads memory from the target system in units of bytes. If necessary, the target CPU is halted in order to read memory.

Syntax

```
mem [<Zone>:]<Addr>, <NumBytes> (hex)
```

Parameter	Meaning
Zone	Name of memory zone to access.
Addr	Start address.
Numbytes	Number of bytes to read. Maximum is 0x100000.

Example

```
mem8 0, 100
```

3.2.1.24 mem16

The command reads memory from the target system in units of 16-bits. If necessary, the target CPU is halted in order to read memory.

Syntax

```
mem [<Zone>:]<Addr>, <NumBytes> (hex)
```

Parameter	Meaning
Zone	Name of memory zone to access.
Addr	Start address.
Numbytes	Number of halfwords to read. Maximum is 0x80000.

Example

```
mem16 0, 100
```

3.2.1.25 mem32

The command reads memory from the target system in units of 32-bits. If necessary, the target CPU is halted in order to read memory.

Syntax

```
mem [<Zone>:]<Addr>, <NumBytes> (hex)
```

Parameter	Meaning
Zone	Name of memory zone to access.
Addr	Start address.
Numbytes	Number of words to read. Maximum is 0x40000.

Example

```
mem32 0, 100
```

3.2.1.26 mem64

The command reads memory from the target system in units of 64-bits. If necessary, the target CPU is halted in order to read memory.

Syntax

```
mem [<Zone>:]<Addr>, <NumBytes> (hex)
```

Parameter	Meaning
Zone	Name of memory zone to access.
Addr	Start address.
Numbytes	Number of double words to read. Maximum is 0x20000.

Example

```
mem64 0, 100
```

3.2.1.27 mr

Measure reaction time of RTCK pin.

Syntax

```
mr [<RepCount>]
```

Parameter	Meaning
RepCount	Number of times the test is repeated (Default: 1).

Example

```
mr 3
```

3.2.1.28 ms

Measures the number of bits in the specified scan chain.

Syntax

```
ms <ScanChain>
```

Parameter	Meaning
<code>ScanChain</code>	Scan chain to be measured.

Example

```
ms 1
```

3.2.1.29 power

This command sets the status of the power supply over pin 19 of the JTAG connector. The KS(Kickstart) versions of J-Link have the 5V supply over pin 19 activated by default. This feature is useful for some targets that can be powered over the JTAG connector.

Syntax

```
power <State> [perm]
```

Parameter	Meaning
<code>State</code>	Valid values: On, Off
<code>perm</code>	Sets the specified State value as default.

Example

```
power on perm
```

3.2.1.30 r

Resets and halts the target.

Syntax

```
r
```

3.2.1.31 readAP

Reads from a CoreSight AP register. This command performs a full-qualified read which means that it tries to read until the read has been accepted or too many WAIT responses have been received. In case actual read data is returned on the next read request (this is the case for example with interface JTAG) this command performs the additional dummy read request automatically.

Syntax

```
ReadAP <RegIndex>
```

Parameter	Meaning
<code>RegIndex</code>	Index of AP register to read

Example

```
//
// Read AP[0], IDR (register 3, bank 15)
//
WriteDP 2, 0x000000F0 // Select AP[0] bank 15
ReadAP 3             // Read AP[0] IDR
```

3.2.1.32 readDP

Reads from a CoreSight DP register. This command performs a full-qualified read which means that it tries to read until the read has been accepted or too many WAIT responses have been received. In case actual read data is returned on the next read request (this is

the case for example with interface JTAG) this command performs the additional dummy read request automatically.

Syntax

ReadDP <RegIndex>

Parameter	Meaning
RegIndex	Index of DP register to read

Example

```
//
// Read DP-CtrlStat
//
ReadDP 1
```

3.2.1.33 regs

Shows all current register values.

Syntax

regs

3.2.1.34 rnh

This command performs a reset but without halting the device.

Syntax

rnh

3.2.1.35 rreg

The function prints the value of the specified CPU register.

Syntax

rreg <RegIndex>

Parameter	Meaning
RegIndex	Register to read.

Example

```
rreg 15
```

3.2.1.36 rx

Resets and halts the target. It is possible to define a delay in milliseconds after reset. This function is useful for some target devices which already contain an application or a boot loader and therefore need some time before the core is stopped, for example to initialize hardware, the memory management unit (MMU) or the external bus interface.

Syntax

rx <DelayAfterReset>

Parameter	Meaning
DelayAfterReset	Delay in ms.

Example

```
rx 10
```

3.2.1.37 savebin

Saves target memory into binary file.

Syntax

```
savebin <Filename>, <Addr>, <NumBytes> (hex)
```

Parameter	Meaning
Filename	Destination file
Addr	Source address.
NumBytes	Number of bytes to read.

Example

```
savebin C:\Work\test.bin 0x0000000 0x100
```

3.2.1.38 setBP

This command sets a breakpoint of a specific type at a specified address. Which breakpoint modes are available depends on the CPU that is used.

Syntax

```
setBP <Addr> [[A/T]/[W/H]] [S/H]
```

Parameter	Meaning
Addr	Address to be breakpointed.
A/T	Only for ARM7/9/11 and Cortex-R4 devices: A: ARM mode T: THUMB mode
W/H	Only for MIPS devices: W: MIPS32 mode (Word) H: MIPS16 mode (Half-word)
S/H	S: Force software BP H: Force hardware BP

Example

```
setBP 0x8000036
```

3.2.1.39 setPC

Sets the PC to the specified value.

Syntax

```
setpc <Addr>
```

Parameter	Meaning
Addr	Address the PC should be set to.

Example

```
setpc 0x59C
```

3.2.1.40 setWP

This command inserts a new watchpoint that matches the specified parameters. The enable bit for the watchpoint as well as the data access bit of the watchpoint unit are set automatically by this command. Moreover the bits DBGEXT, CHAIN and the RANGE bit (used to connect one watchpoint with the other one) are automatically masked out. In order to use these bits you have to set the watchpoint by writing the ICE registers directly.

Syntax

```
setWP <Addr> [<AccessType>] [<Size>] [<Data> [<DataMask> [<AddrMask>]]]
```

Parameter	Meaning
Addr	Address to be watchpointed.
Accesstype	Specifies the control data on which data event has been set: R: read access W: write access
Size	Valid values: S8 S16 S32 Specifies to monitor an n-bit access width at the selected address.
Data	Specifies the Data on which watchpoint has been set.
DataMask	Specifies data mask used for comparison. Bits set to 1 are masked out, so not taken into consideration during data comparison. Please note that for certain cores not all Bit-Mask combinations are supported by the core-debug logic. On some cores only complete bytes can be masked out (e.g. PIC32) or similar.
AddrMask	Specifies the address mask used for comparison. Bits set to 1 are masked out, so not taken into consideration during address comparison. Please note that for certain cores not all Bit-Mask combinations are supported by the core-debug logic. On some cores only complete bytes can be masked out (e.g. PIC32) or similar.

Example

```
setWP 0x20000000 W S8 0xFF
```

3.2.1.41 sleep

Waits the given time (in milliseconds).

Syntax

```
sleep <Delay>
```

Parameter	Meaning
Delay	Amount of time to sleep in ms.

Example

```
sleep 200
```

3.2.1.42 speed

This command sets the speed for communication with the CPU core.

Syntax

```
speed <Freq>|auto|adaptive
```

Parameter	Meaning
Freq	Specifies the interface frequency in kHz.

Parameter	Meaning
<code>auto</code>	Selects auto detection of the interface speed.
<code>adaptive</code>	Selects adaptive clocking as JTAG speed.

Example

```
speed 4000
speed auto
```

3.2.1.43 st

This command prints the current hardware status. Prints the current status of TCK, TDI, TDO, TMS, TRES, TRST and the interface speeds supported by the target. Also shows the Target Voltage.

Syntax

```
st
```

3.2.1.44 step

Target needs to be halted before calling this command. Executes a single step on the target. The instruction is overstepped even if it is breakpointed. Prints out the disassembly of the instruction to be stepped.

Syntax

```
step
```

3.2.1.45 unlock

This command unlocks a device which has been accidentally locked by malfunction of user software.

Syntax

```
unlock <DeviceName>
```

Parameter	Meaning
<code>DeviceName</code>	Name of the device family to unlock. Supported Devices: LM3Sxxx Kinetis EFM32Gxxx

Example

```
unlock Kinetis
```

3.2.1.46 usb

Closes any existing connection to J-Link and opens a new one via USB. It is possible to select a specific J-Link by port number.

Syntax

```
usb [<Port>]
```

Parameter	Meaning
<code>Port</code>	Valid values: 0..3

Example

```
usb
```

3.2.1.47 verifybin

Verifies if the specified binary is already in the target memory at the specified address.

Syntax

```
verifybin <Filename>, <Addr>
```

Parameter	Meaning
Filename	Sample bin.
Addr	Start address of memory to verify.

Example

```
verifybin C:\Work\test.bin 0x0000000
```

3.2.1.48 VTREF

Sets a fixed value for VTref on J-Link. The Value of VTref can be set between 1200 mV and 3300 mV all values that exceed 3300 mV will be limited to 3300 mV, values smaller than 1200 mV deactivate fixed VTref. Settings of fixed VTref apply nonvolatile after power cycling the probe.

Syntax

```
VTREF <ValuemV>
```

Parameter	Meaning
ValuemV	value in Millivolt

Example

```
VTREF 3300
```

3.2.1.49 w1

The command writes one single byte to the target system.

Syntax

```
w1 [<Zone>:]<Addr>, <Data> (hex)
```

Parameter	Meaning
Zone	Name of memory zone to access.
Addr	Start address.
Data	8-bits of data to write.

Example

```
w1 0x10, 0xFF
```

3.2.1.50 w2

The command writes a unit of 16-bits to the target system.

Syntax

```
w2 [<Zone>:]<Addr>, <Data> (hex)
```

Parameter	Meaning
Zone	Name of memory zone to access.
Addr	Start address.
Data	16-bits of data to write.

Example

```
w2 0x0, 0xFFFF
```

3.2.1.51 w4

The command writes a unit of 32-bits to the target system.

Syntax

```
w4 [<Zone>:]<Addr>, <Data> (hex)
```

Parameter	Meaning
Zone	Name of memory zone to access.
Addr	Start address.
Data	32-bits of data to write.

Example

```
w4 0x0, 0xAABBCCFF
```

3.2.1.52 writeAP

Writes to a CoreSight AP register. This command performs a full-qualified write which means that it tries to write until the write has been accepted or too many WAIT responses have been received.

Syntax

```
WriteAP <RegIndex>, <Data32Hex>
```

Parameter	Meaning
RegIndex	Index of AP register to write
Data32Hex	Data to write

Example

```
//
// Select AHB-AP and configure it
//
WriteDP 2, 0x00000000 // Select AP[0] (AHB-AP) bank 0
WriteAP 4, 0x23000010 // Auto-increment, Private access, Access size: word}
```

3.2.1.53 writeDP

Writes to a CoreSight DP register. This command performs a full-qualified write which means that it tries to write until the write has been accepted or too many WAIT responses have been received.

Syntax

```
WriteDP <RegIndex>, <Data32Hex>
```

Parameter	Meaning
RegIndex	Index of DP register to write

Parameter	Meaning
Data32Hex	Data to write

Example

```
//
// Write DP SELECT register: Select AP 0 bank 15
//
WriteDP 2, 0x000000F0
```

3.2.1.54 wreg

Writes into a register. The value is written into the register on CPU start.

Syntax

```
wreg <RegName>, <Data>
```

Parameter	Meaning
RegName	Register to write to.
Data	Data to write to the specified register.

Example

```
wreg R14, 0xFF
```

3.2.2 Command line options

J-Link Commander can be started with different command line options for test and automation purposes. In the following, the command line options which are available for J-Link Commander are explained. All command line options are case insensitive.

Command	Explanation
-AutoConnect	Automatically start the target connect sequence
-CommanderScript	Passes a CommanderScript to J-Link
-CommandFile	Passes a CommandFile to J-Link
-Device	Pre-selects the device J-Link Commander shall connect to
-ExitOnError	Commander exits after error
-If	Pre-selects the target interface
-IP	Selects IP as host interface
-JLinkScriptFile	Passes a JLinkScriptFile to J-Link
-JTAGConf	Sets IRPre and DRPre
-Log	Sets logfile path
-RTTtelnetPort	Sets the RTT Telnetport
USB	Connects to a J-Link with a specific S/N over USB.
-SettingsFile	Passes a SettingsFile to J-Link
-Speed	Starts J-Link Commander with a given initial speed

3.2.2.1 -AutoConnect

This command can be used to let J-Link Commander automatically start the connect sequence for connecting to the target when entering interactive mode.

Syntax

```
-autoconnect <1|0>
```

Example

```
JLink.exe -autoconnect 1
```

3.2.2.2 -CommanderScript

Similar to [-CommandFile](#).

3.2.2.3 -CommandFile

Selects a command file and starts J-Link Commander in batch mode. The batch mode of J-Link Commander is similar to the execution of a batch file. The command file is parsed line by line and one command is executed at a time.

Syntax

```
-CommandFile <CommandFilePath>
```

Example

See *Using J-Link Command Files* on page 59.

3.2.2.4 -Device

Pre-selects the device J-Link Commander shall connect to. For some devices, J-Link already needs to know the device at the time of connecting, since special handling is required for some of them. For a list of all supported device names, please refer to [List of supported target devices](#).

Syntax

```
-Device <DeviceName>
```

Example

```
JLink.exe -Device STM32F103ZE
```

3.2.2.5 -ExitOnError

Similar to the [exitonerror](#) command.

3.2.2.6 -If

Selects the target interface J-Link shall use to connect to the target. By default, J-Link Commander first tries to connect to the target using the target interface which is currently selected in the J-Link firmware. If connecting fails, J-Link Commander goes through all target interfaces supported by the connected J-Link and tries to connect to the device.

Syntax

```
-If <TargetInterface>
```

Example

```
JLink.exe -If SWD
```

Additional information

Currently, the following target interfaces are supported:

- JTAG
- SWD

3.2.2.7 -IP

Selects IP as host interface to connect to J-Link. Default host interface is USB.

Syntax

```
-IP <IPAddr>
```

Example

```
JLink.exe -IP 192.168.1.17
```

Additional information

To select from a list of all available emulators on Ethernet, please use * as <IPAddr> .

3.2.2.8 -JLinkScriptFile

Passes the path of a J-Link script file to the J-Link Commander. J-Link scriptfiles are mainly used to connect to targets which need a special connection sequence before communication with the core is possible. For more information about J-Link script files, please refer to *J-Link Script Files* .

Syntax

```
JLink.exe -JLinkScriptFile <File>
```

Example

```
JLink.exe -JLinkScriptFile "C:\My Projects\Default.JLinkScript"
```

3.2.2.9 -JTAGConf

Passes IRPre and DRPre in order to select a specific device in a JTAG-chain. "-1,-1" can be used to let J-Link select a device automatically.

Syntax

```
-JTAGConf <IRPre>,<DRPre>
```

Example

```
JLink.exe -JTAGConf 4,1  
JLink.exe -JTAGConf -1,-1
```

3.2.2.10 -Log

Set path to LogFilePath allowing the DLL to output logging information. If the logfile already exists, the contents of the current logfile will be overwritten.

Syntax

```
-Log <LogFilePath>
```

Example

```
JLink.exe -Log C:\Work\log.txt
```

3.2.2.11 -RTTtelnetPort

This command alters the RTT telnet port. Default is 19021.

Syntax

```
-RTTtelnetPort <Port>
```

Example

```
JLink.exe -RTTNetPort 9100
```

3.2.2.12 USB

Connect to a J-Link with a specific serial number via USB. Useful if multiple J-Links are connected to the same PC and multiple instances of J-Link Commander shall run and each connects to another J-Link.

Syntax

```
USB <SerialNo>
```

Example

```
JLink.exe USB 580011111
```

3.2.2.13 -SettingsFile

Select a J-Link settings file to be used for the target device. The settings file can contain all configurable options of the Settings tab in J-Link Control panel.

Syntax

```
-SettingsFile <PathToFile>
```

Example

```
JLink.exe -SettingsFile "C:\Work\settings.txt"
```

3.2.2.14 -Speed

Starts J-Link Commander with a given initial speed. Available parameters are "adaptive", "auto" or a freely selectable integer value in kHz. It is recommended to use either a fixed speed or, if it is available on the target, adaptive speeds. Default interface speed is 100kHz.

Syntax

```
-Speed <Speed_kHz>
```

Example

```
JLink.exe -Speed 4000
```

3.2.3 Using J-Link Command Files

J-Link commander can also be used in batch mode which allows the user to use J-Link commander for batch processing and without user interaction. Please do not confuse J-Link Command Files file with J-Link Script Files (please refer to *J-Link Script Files* for more information about J-Link script files). When using J-Link commander in batch mode, the path to a command file is passed to it. The syntax in the command file is the same as when using regular commands in J-Link commander (one line per command). SEGGER recommends to always pass the device name via command line option due some devices need special handling on connect/reset in order to guarantee proper function.

Example

```
JLink.exe -device STM32F103ZE -CommandFile C:\CommandFile.jlink
```

Contents of CommandFile.jlink:

```
si 1
speed 4000
r
```

```
h  
loadbin C:\firmware.bin,0x08000000
```

3.3 J-Link Remote Server

J-Link Remote Server allows using J-Link / J-Trace remotely via TCP/IP. This enables you to connect to and fully use a J-Link / J-Trace from another computer. Performance is just slightly (about 10%) lower than with direct USB connection.

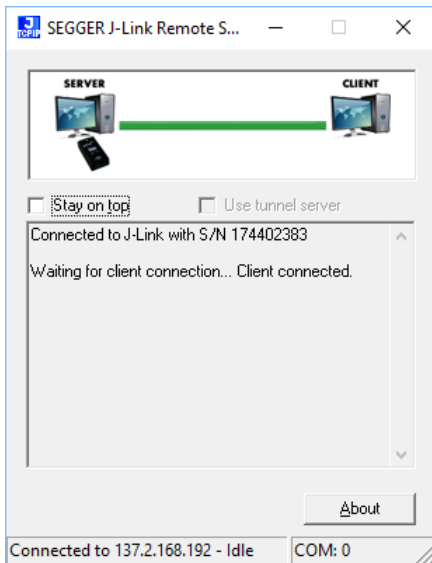

J-Link Remote Server

3.3.1 List of available commands

The table below lists the commands line options accepted by the J-Link Remote Server

Command	Description
?	Prints the list of available command line options.
-Port	Specifies listening port of J-Link Remote Server.
-UseTunnel	Specifies if tunneled connection shall be used.
-SelectEmuBySN	Specifies to connect to a J-Link with a specific S/N. Only valid for LAN mode.
-TunnelServer	Specify a tunnel server to connect to (default: jlink.segger.com:19020). Only valid for tunnel mode.
-TunnelBySN	Specifies to identify at tunnel server via J-Link S/N. Only valid for tunnel mode.
-TunnelByName	Specifies to identify at tunnel server via custom name. Only valid for tunnel mode.
-TunnelPW	Specifies to protect the connection with a password. Only valid for tunnel mode.
-TunnelPort	Specifies to connect to a tunnel server listening on a specific port. Only valid for tunnel mode.
-select	<USB/IP> [= <SN/Hostname>] Specify how to connect to J-Link.
-port 1	Selects the IP port on which the J-Link Remote Server is listening.
-UseTunnel 1	Starts J-Link Remote Server in tunneling mode
-SelectEmuBySN 1	Selects the J-Link to connect to by its serial number.

Note

1: These command line options exist because of backwards-compatibility. We suggest to use the command line options that start with a dash ('-').

3.3.2 Tunneling mode

The Remote server provides a tunneling mode which allows remote connection to a J-Link / J-Trace from any computer, even from outside the local network.

To give access to a J-Link neither a remote desktop or VPN connection nor changing some difficult firewall settings is necessary.

When started in tunneling mode the Remote server connects to the SEGGER tunnel server via port 19020 and registers with its serial number. To connect to the J-Link from the remote computer an also simple connection to tunnel:<SerialNo> can be established and the debugger is connected to the J-Link.

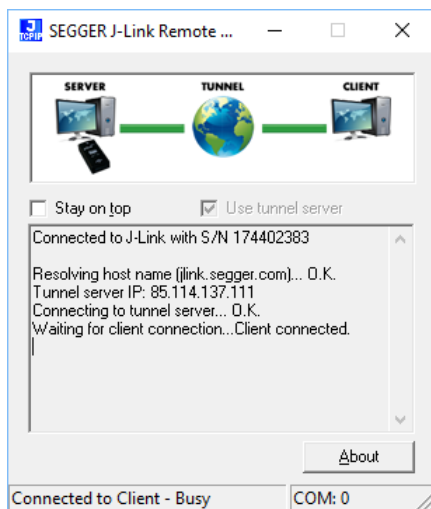
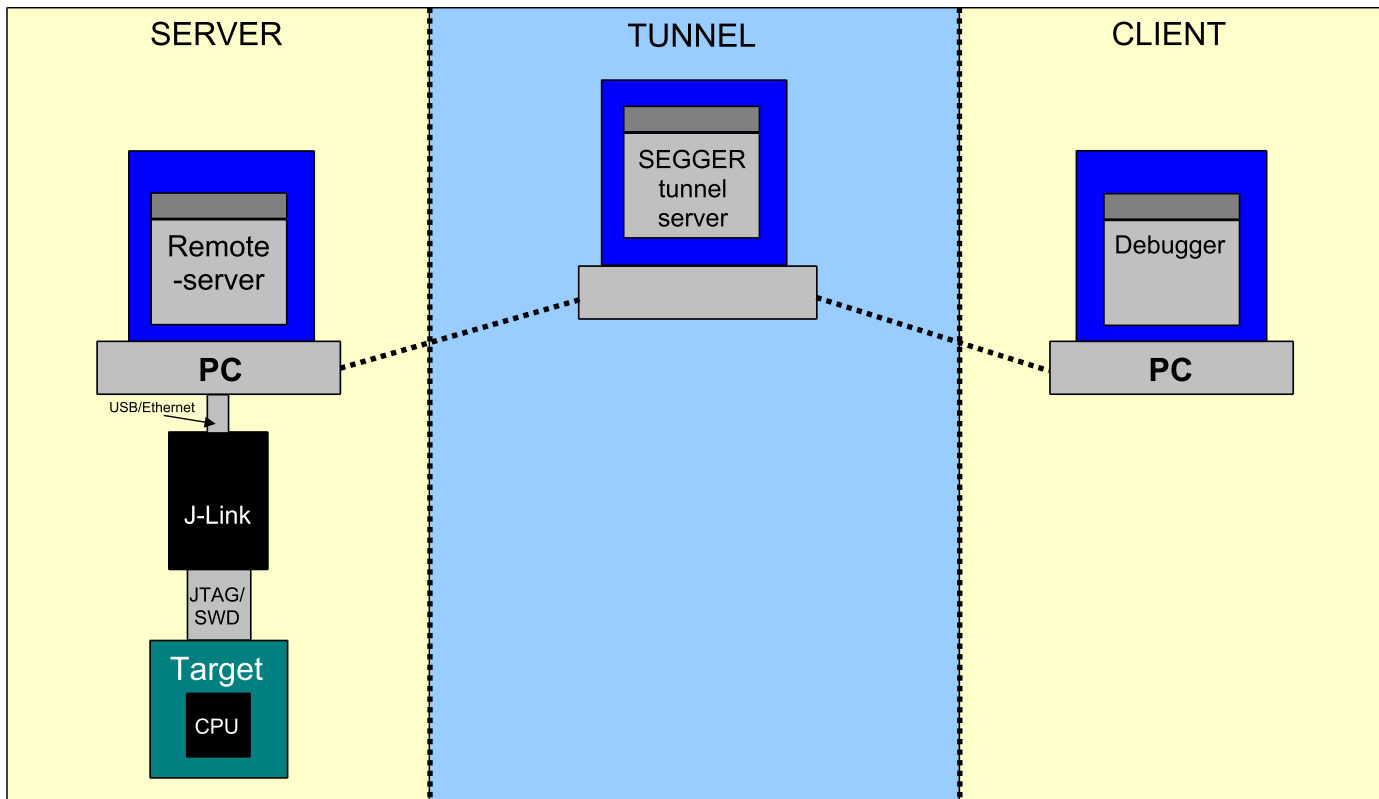

J-Link Remote Server: Connected to SEGGER tunnel server

Example scenario

A device vendor is developing a new device which shall be supported by J-Link. Because there is only one prototype, a shipment to SEGGER is not possible.

Instead the vendor can connect the device via J-Link to a local computer and start the Remote server in tunneling mode. The serial number of the J-Link is then sent to a to an engineer at SEGGER.

The engineer at SEGGER can use J-Link Commander or a debugger to test and debug the new device without the need to have the device on the desk.

Start J-Link Remote Server in tunneling mode

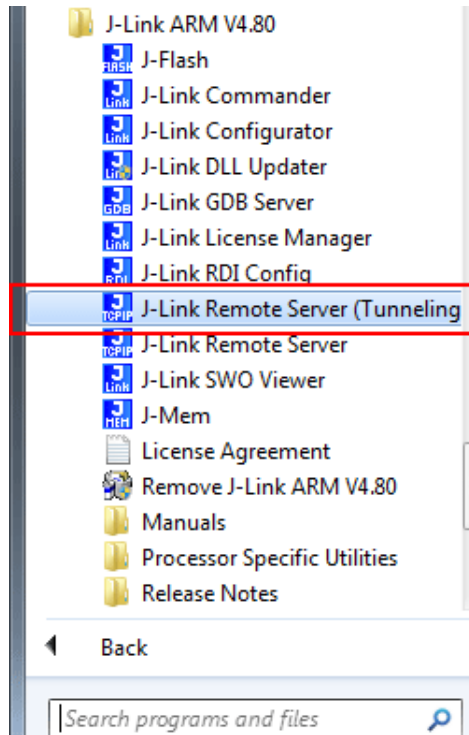

Connect to the J-Link / J-Trace via J-Link Commander

J-Link Commander can be used to verify a connection to the J-Link can be established as follows: Start J-Link Commander

From within J-Link Commander enter

```
ip tunnel:<SerialNo>
```

If the connection was successful it should look like in this screenshot.

```

C:\Program Files (x86)\SEGGER\JLink_V614\JLink.exe
SEGGER J-Link Commander V6.14 (Compiled Feb 23 2017 17:30:02)
DLL version V6.14, compiled Feb 23 2017 17:29:32

Connecting to J-Link via USB...O.K.
Firmware: J-Link Pro V4 compiled Apr 21 2017 11:15:52
Hardware version: V4.00
S/N: 174402383
License(s): RDI, FlashBP, FlashDL, JFlash, GDB
IP-Addr: DHCP (no addr. received yet)
VTref = 3.298V

Type "connect" to establish a target connection, '?' for help
J-Link>ip tunnel:174402383
Connecting to tunnel:174402383
Disconnecting from J-Link...O.K.
Connecting to J-Link via IP...O.K.
Firmware: J-Link Pro V4 compiled Apr 21 2017 11:15:52
Hardware version: V4.00
S/N: 174402383
License(s): RDI, FlashBP, FlashDL, JFlash, GDB
IP-Addr: DHCP (no addr. received yet)
VTref = 3.300V
J-Link>

```

Troubleshooting

Problem	Solution
Remote server cannot connect to tunnel server.	<ol style="list-style-type: none"> 1. Make sure the Remote server is not blocked by any firewall. 2. Make sure port 19020 is not blocked by any firewall. 3. Contact network admin.
J-Link Commander cannot connect to tunnel server.	<ol style="list-style-type: none"> 1. Make sure Remote server is started correctly. 2. Make sure the entered serial number is correct. 3. Make sure port 19020 is not blocked by any firewall. Contact network admin.

To test whether a connection to the tunnel server can be established or not a network protocol analyzer like Wireshark can help. The network transfer of a successful connection should look like:

Source	Destination	Protocol	Info
192.168.11.31	88.84.155.118	TCP	51439 > j-link [SYN] seq=0 win=81
88.84.155.118	192.168.11.31	TCP	j-link > 51439 [SYN, ACK] Seq=0 A
192.168.11.31	88.84.155.118	TCP	51439 > j-link [ACK] Seq=1 Ack=1
192.168.11.31	88.84.155.118	TCP	51439 > j-link [PSH, ACK] Seq=1 A
192.168.11.31	88.84.155.118	TCP	51439 > j-link [PSH, ACK] Seq=5 A
88.84.155.118	192.168.11.31	TCP	j-link > 51439 [ACK] Seq=1 Ack=5
88.84.155.118	192.168.11.31	TCP	j-link > 51439 [ACK] Seq=1 Ack=9
88.84.155.118	192.168.11.31	TCP	j-link > 51439 [PSH, ACK] Seq=1 A
192.168.11.31	88.84.155.118	TCP	51439 > j-link [PSH, ACK] Seq=9 A
192.168.11.31	88.84.155.118	TCP	51439 > j-link [PSH, ACK] Seq=13
88.84.155.118	192.168.11.31	TCP	j-link > 51439 [ACK] Seq=5 Ack=80

3.4 J-Mem Memory Viewer

J-Mem is a GUI application to display and modify the RAM and SFRs (Special Function Registers) of target systems while the target is running.

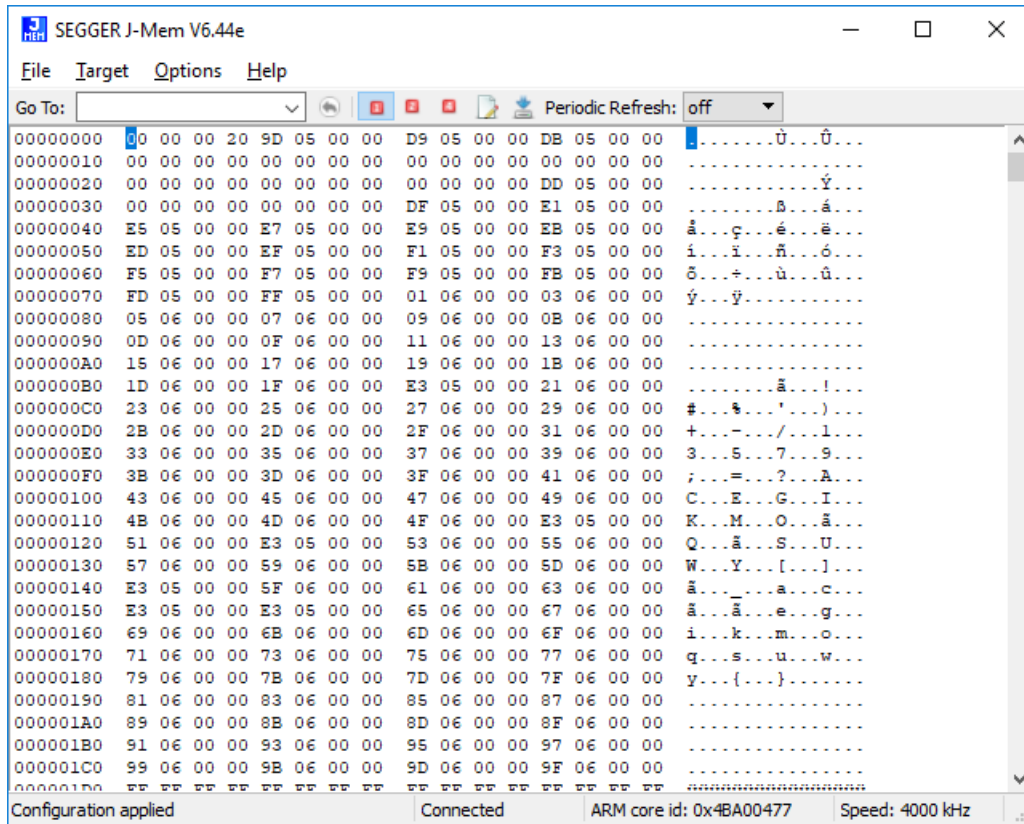

For more information on how to use J-Mem, please refer to *J-Mem* on page 134

3.5 J-Flash

J-Flash is an application to program data images to the flash of a target device. With J-Flash the internal flash of all J-Link supported devices can be programmed, as well as common external flashes connected to the device. Beside flash programming all other flash operations like erase, blank check and flash content verification can be done.

J-Flash requires an additional license from SEGGER to enable programming. For license keys, as well as evaluation licenses got to www.segger.com or contact us directly.

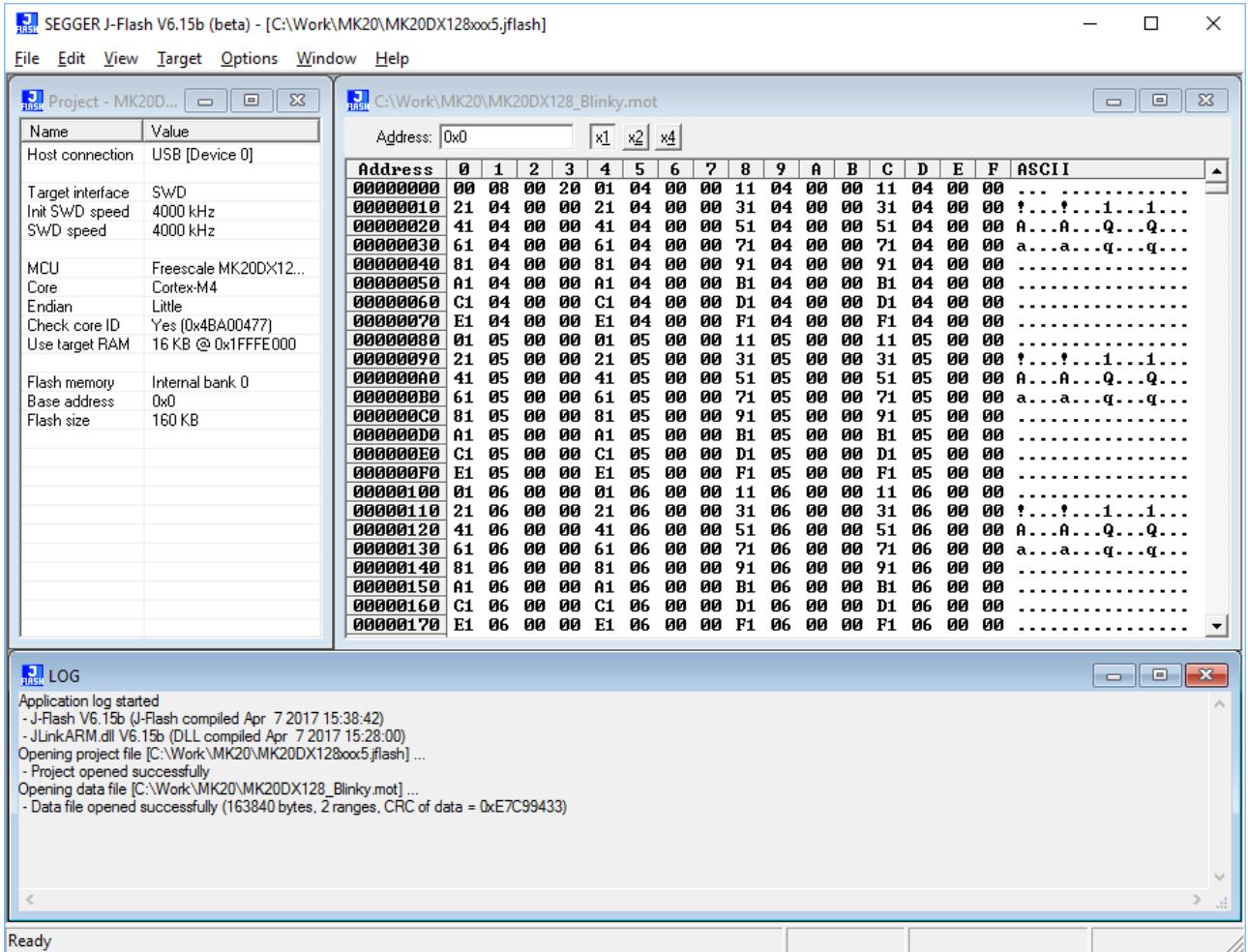

3.6 J-Flash Lite

J-Flash Lite is a flash programming application to program data images to the flash of a target device. In comparison to J-Flash, J-Flash Lite has a reduced feature set but does not require a J-Link PLUS or higher to operate. J-Flash Lite is also available for J-Link BASE and EDU.

3.6.1 Limitations in comparison to J-Flash

- No support for external CFI NOR flash
- No support for custom Init steps
- No support for automation via command line
- No project management support (Only the settings from the last session are pre-selected on startup)

3.6.2 Usage

J-Flash Lite is very simple to use. First, a configuration dialog shows up, in which the target interface, target device etc. has to be selected. By clicking the O.K. button, the configuration is applied and the actual main window is shown.

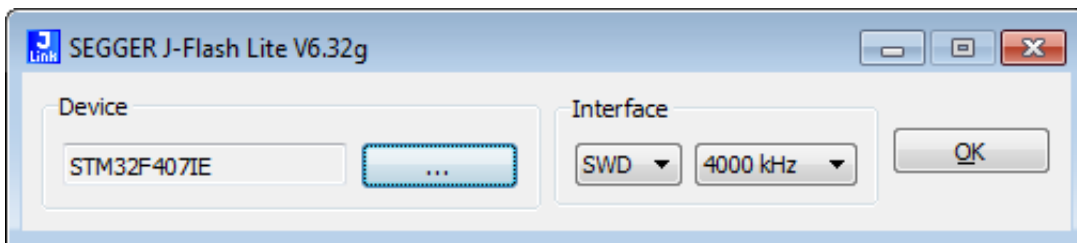

The main window of J-Flash Lite only consists of a few dialog elements that allow programming of the target:

Dialog element	Function
"..." button	Selects the application image (bin, hex, mot, ...) to program
"Erase chip" button	Erases all flash banks of the device
"Program Device" button	Programs the selected application image

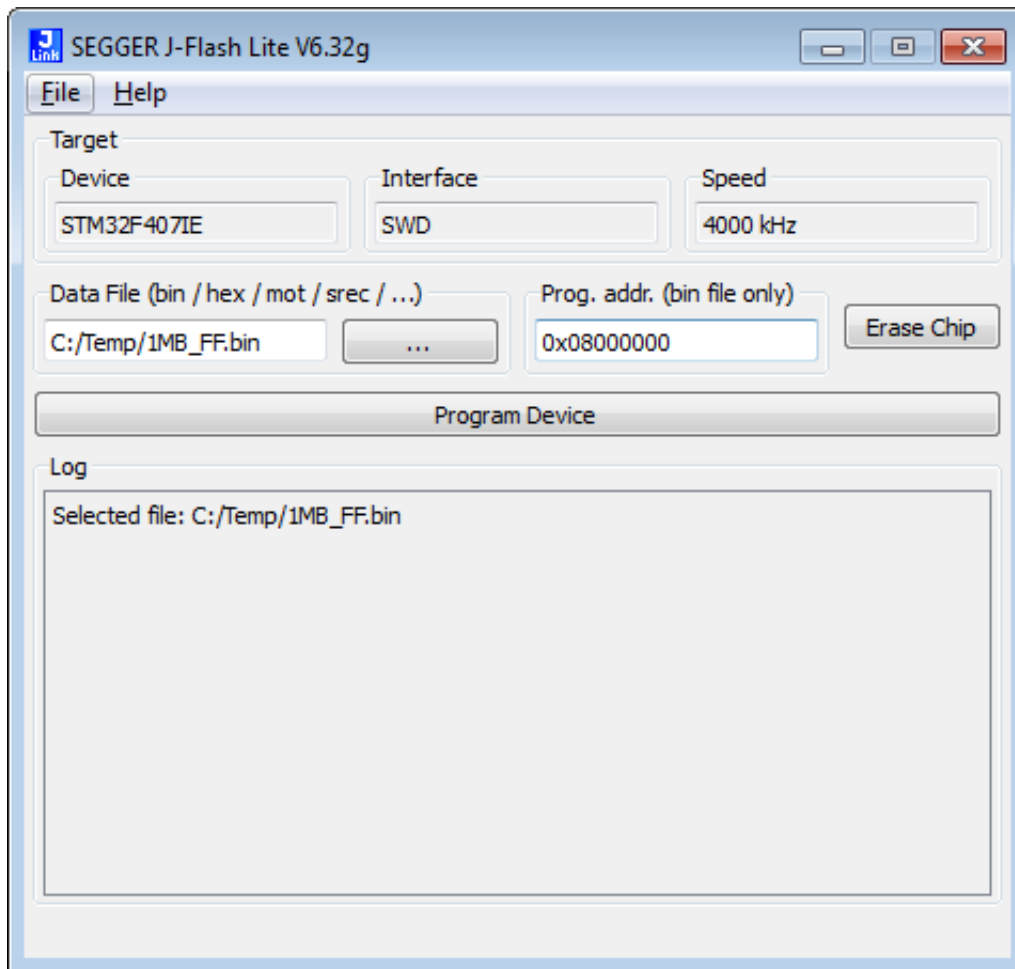

3.7 J-Link RTT Viewer

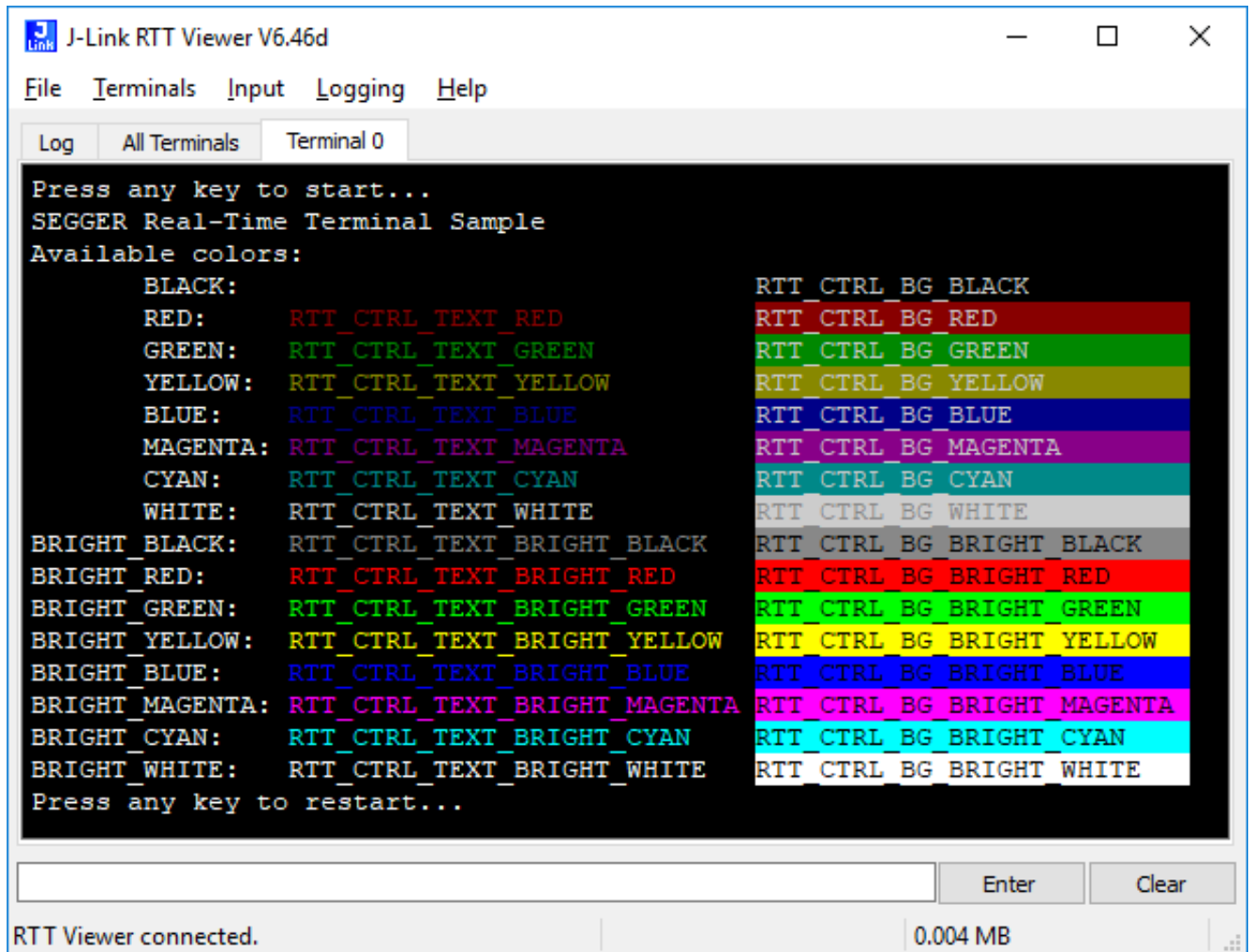

J-Link RTT Viewer is a GUI application available for Windows, MacOS and Linux. It enables you to use all features of RTT in one application.

It supports:

- Displaying terminal output of Channel 0.
- Up to 16 virtual Terminals on Channel 0.
- Sending text input to Channel 0.
- Interpreting text control codes for colored text and controlling the Terminal.
- Logging terminal data into a file.
- Logging data on Channel 1.

For general information about RTT, please refer to *RTT* on page 344.

3.7.1 RTT Viewer Startup

Make sure J-Link and target device are connected and powered up.

Start RTT Viewer by opening the executable (JLinkRTTViewer.exe) from the installation folder of the J-Link Software or the start menu. Unless the command line parameter `--autoconnect` is set, the Configuration Dialog will pop up.

Configure the Connection Settings as described below and click OK. The connection settings and all in app configuration will be saved for the next start of J-Link RTT Viewer.

3.7.2 Connection Settings

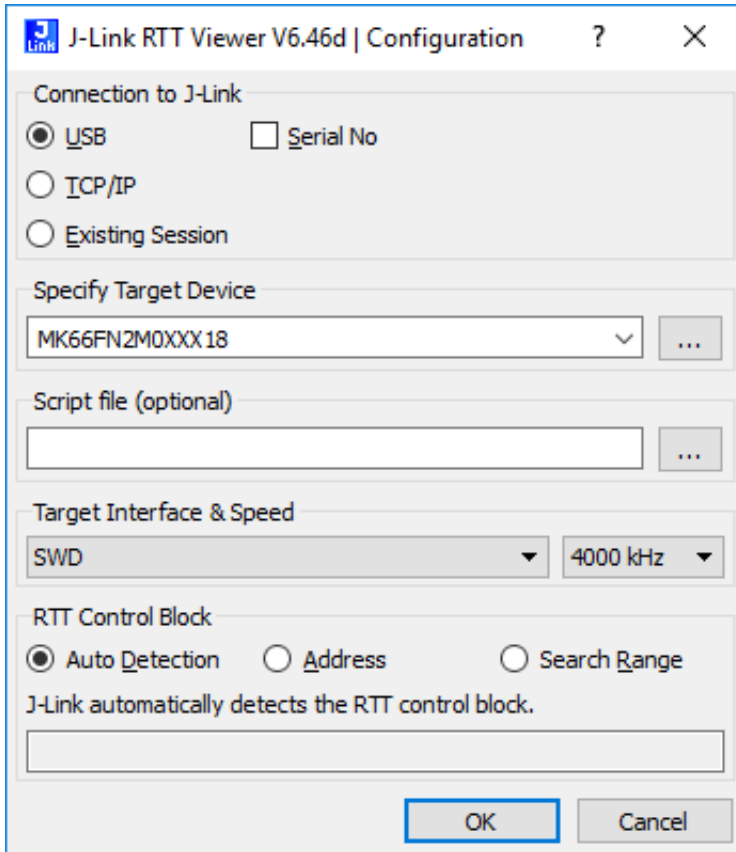

RTT Viewer can be used in two modes:

- Stand-alone, opening an own connection to J-Link and target.
- In attach mode, connecting to an existing J-Link connection of a debugger.

Stand-alone connection settings

In stand-alone mode RTT Viewer needs to know some settings of J-Link and target device. Select USB or TCP/IP as the connection to J-Link. For USB a specific J-Link serial number can optionally be entered, for TCP/IP the IP or hostname of the J-Link has to be entered. Select the target device to connect to. This allows J-Link to search in the known RAM of the target.

Select the target interface and its speed. The RTT Control Block can be searched for fully automatically, it can be set to a fixed address or it can be searched for in one or more specific memory ranges.

Attaching to a connection

In attach mode RTT Viewer does not need any settings. Select Existing Session. For attach mode a connection to J-Link has to be opened and configured by another application like a debugger or simply J-Link Commander. If the RTT Control Block cannot be found automatically, configuration of its location has to be done by the debugger / application.

3.7.3 The Terminal Tabs

RTT Viewer allows displaying the output of Channel 0 in different "virtual" Terminals. The target application can switch between terminals with `SEGGER_RTT_SetTerminal()` and `SEGGER_RTT_TerminalOut()`. RTT Viewer displays the Terminals in different tabs.

Log	All Terminals	Terminal 0	Terminal 1	Terminal 2
00> SEGGER Real-Time-Terminal Sample				
01> Using Terminal 1 for error output				
02> Terminal 2 sends additional debug information				
< Sending some input.				
00> Sending some input.				

All Terminals

The All Terminals tab displays the complete output of RTT Channel 0 and can display the user input (Check Input -> Echo input... -> Echo to "All Terminals"). Each output line is prefixed by the Terminal it has been sent to. Additionally, output on Terminal 1 is shown in red, output on Terminals 2 - 15 in gray.

Terminal 0 - 15

Each tab Terminal 0 - Terminal 15 displays the output which has been sent to this Terminal. The Terminal tabs interpret and display Text Control Codes as sent by the application to show colored text or erase the screen.

By default, if the RTT application does not set a Terminal Id, the output is displayed in Terminal 0.

The Terminal 0 tab can additionally display the user input. (Check Input -> Echo input... -> Echo to "Terminal 0")

Each Terminal tab can be shown or hidden via the menu Terminals -> Terminals... or their respective shortcuts as described below.

3.7.4 Sending Input

RTT Viewer supports sending user input to RTT Down Channel 0 which can be read by the target application with `SEGGER_RTT_GetKey()` and `SEGGER_RTT_Read()`.

Input can be entered in the text box below the Terminal Tabs.

RTT Viewer can be configured to directly send each character while typing or buffer it until Enter is pressed (Menu Input -> Sending...).

In stand-alone mode RTT Viewer can retry to send input, in case the target input buffer is full, until all data could be sent to the target via Input -> Sending... -> Block if FIFO full.

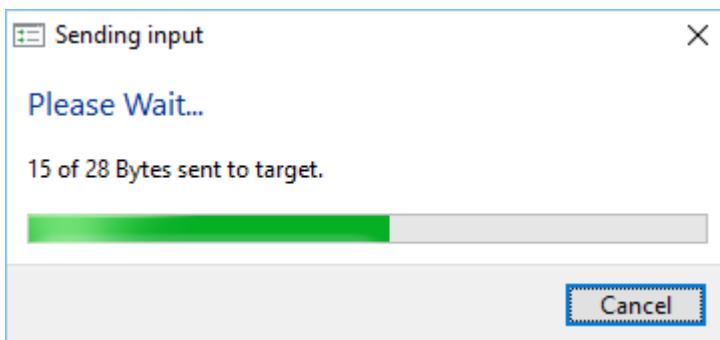

3.7.5 Logging Terminal output

The output of Channel 0 can be logged into a text file. The format is the same as used in the All Terminals tab. Terminal Logging can be started via Logging -> Start Terminal Logging...

3.7.6 Logging Data

Additionally to displaying output of Channel 0, RTT Viewer can log data which is sent on RTT Channel 1 into a file. This can for example be used to sent instrumented event tracing data. The data log file contains header and footer and the binary data as received from the application.

Data Logging can be started via Logging -> Start Data Logging...

Note

Data Logging is only available in stand-alone mode.

3.7.7 Command line options

J-Link RTT Viewer can be configured via command line parameters. In the following, the command line options which are available for J-Link RTT Viewer are explained. All command line options are case insensitive. Short and long command names have the same syntax.

Command line option	Explanation
-b, --bright	Bright theme for GUI
-d, --device	Select the connected target device.
-ct, --connection	Sets the connection type
-if, --interface	Sets the interface type
-ip, --host	The IP address of the J-Link
-s, --speed	Interface speed in kHz
-sf, --scriptfile	Executes a command script on start up
-sn, --serialnumber	Select the J-Link with a specific S/N.
-ra, --rttaddr	Sets the address of the RTT control block
-rr, --rttrange	Specify RTT search range
-a, --autoconnect	Automatically connect to target, suppress settings dialog

3.7.7.1 --bright

Starts the RTT Viewer in bright theme

Syntax

```
--bright
```

Example

```
JLinkRTTViewer.exe --bright
```

3.7.7.2 --device

Selects the device J-Link RTT Viewer shall connect to.

Syntax

```
--device <DeviceName>
```

Example

```
JLinkRTTViewer.exe --device STM32F103ZE
```

3.7.7.3 --connection

Sets the connection type. The connection to the J-Link can either be made directly over USB, IP or using an existing running session (e.g. the IDE's debug session). In case of using an existing session, no further configuration options are required.

Syntax

```
--connection <usb|ip|sess>
```

Example

```
JLinkRTTViewer.exe --connection ip
```

3.7.7.4 --interface

Sets the interface J-Link shall use to connect to the target. As interface types FINE, JTAG and SWD are supported.

Syntax

```
--interface <fine|jtag|swd>
```

Example

```
JLinkRTTViewer.exe --interface swd
```

3.7.7.5 --host

Enter the IP address or hostname of the J-Link. This option only applies, if connection type IP is used. Use * as <IPAddr> for a list of available J-Links in the local subnet.

Syntax

```
--host <IPAddr>
```

Example

```
JLinkRTTViewer.exe --host 192.168.1.17
```

3.7.7.6 --speed

Sets the interface speed in kHz for target communication.

Syntax

```
--speed <speed>
```

Example

```
JLinkRTTViewer.exe --speed 4000
```

3.7.7.7 --scriptfile

Executes a JLink command script on startup, setting options in advance (e.g. Device = AT91SAM7S256)

Syntax

```
--scriptfile <FilePath>
```

Example

```
JLinkRTTViewer.exe --scriptfile C:\tmp\<<Scriptfilename>
```

3.7.7.8 --serialnumber

Connect to a J-Link with a specific serial number via USB. Useful if multiple J-Links are connected to the same PC and multiple instances of J-Link RTT Viewer shall run and each connects to another J-Link.

Syntax

```
--serialnumber <SerialNo>
```

Example

```
JLinkRTTViewer.exe --serialnumber 580011111
```

3.7.7.9 --rttaddr

Sets a fixed address as location of the RTT control block. Automatic searching for the RTT control block is disabled.

Syntax

```
--rttaddr <RTTCBAddr>
```

Example

```
JLinkRTTViewer.exe -rttaddr 0x20000000
```

3.7.7.10 --rttrange

Sets one or more memory ranges, where the J-Link DLL shall search for the RTT control block.

Syntax

```
--rttrange <RangeStart[Hex]> <RangeSize >[, <Range1Start [Hex]> <Range1Size>]>
```

Example

```
JLinkRTTViewer.exe -rttrange "20000000 400"
```

3.7.7.11 --autoconnect

Let J-Link RTT Viewer connect automatically to the target without showing the Connection Settings (see *Connection Settings*).

Syntax

```
--autoconnect
```

Example

```
JLinkRTTViewer.exe --autoconnect
```

3.7.8 Menus and Shortcuts**File menu elements**

Menu entry	Contents	Shortcut
-> Connect...	Opens the connect dialog and connects to the targets	F2
-> Disconnect	Disconnects from the target	F3
-> Exit	Closes connection and exit RTT Viewer.	Alt-F4

Terminals menu elements

Menu entry	Contents	Shortcut
-> Add next terminal	Opens the next available Terminal Tab.	Alt-A
-> Clear active terminal	Clears the currently selected terminal tab.	Alt-R
-> Close active terminal	Closes the active Terminal Tab.	Alt-W

Menu entry	Contents	Shortcut
-> Open Terminal on output	If selected, a terminal is automatically created, if data for this terminal is received.	
-> Show Log	Opens or closes the Log Tab.	Alt-L
Terminals -> Terminals...		
-> Terminal 0 - 15	Opens or closes the Terminal Tab.	Alt-Shift-0 Alt-Shift-F

Input menu elements

Menu entry	Contents	Shortcut
-> Clear input field	Clears the input field without sending entered data.	Button "Clear"
Input -> Sending...		
-> Send on Input	If selected, entered input will be sent directly to the target while typing.	
-> Send on Enter	If selected, entered input will be sent when pressing Enter.	
-> Block if FIFO full	If checked, RTT Viewer will retry to send all input to the target when the target buffer is full.	
Input -> End of line...		
-> Windows format (CR+LF) -> Unix format (LF) -> Mac format (CR) -> None	Selects the end of line character to be sent on Enter.	
Input -> Echo input...		
-> Echo to "All Terminals"	If checked, sent input will be displayed in the All Terminals Tab.	
-> Echo to "Terminal 0"	If checked, sent input will be displayed in the Terminal Tab 0.	

Logging menu elements

Menu entry	Contents	Shortcut
-> Start Terminal logging...	Starts logging terminal data to a file.	F5
-> Stop Terminal logging	Stops logging terminal data and closes the file.	Shift-F5
-> Start Data logging...	Starts logging data of Channel 1 to a file.	F6
-> Stop Data logging	Stops logging data and closes the file.	Shift-F6
-> Channel infos...	Displays information about all available RTT channels.	F8

Help menu elements

Menu entry	Contents	Shortcut
-> About...	Shows version info of RTT Viewer.	F12
-> J-Link Manual...	Opens the J-Link Manual PDF file.	F11
-> RTT Webpage...	Opens the RTT webpage.	F10

Tab context menu elements

Menu entry	Contents	Shortcut
-> Close Terminal	Closes this Terminal Tab	Alt-W
-> Clear Terminal	Clears the displayed output of this Terminal Tab.	Alt-R

3.7.9 Using "virtual" Terminals in RTT

For virtual Terminals the target application needs only Up Channel 0. This is especially important on targets with low RAM.

If nothing is configured, all data is sent to Terminal 0.

The Terminal to output all following via Write, WriteString or printf can be set with SEGGER_RTT_SetTerminal().

Output of only one string via a specific Terminal can be done with SEGGER_RTT_TerminalOut().

The sequences sent to change the Terminal are interpreted by RTT Viewer. Other applications like a Telnet Client will ignore them.

3.7.10 Using Text Control Codes

RTT allows using Text Control Codes (ANSI escape codes) to configure the display of text. RTT Viewer supports changing the text color and background color and can erase the Terminal. These Control Codes are pre-defined in the RTT application and can easily be used in the application.

Example 1

```
SEGGER_RTT_WriteString(0,
    RTT_CTRL_RESET"Red: " \
    RTT_CTRL_TEXT_BRIGHT_RED"This text is red. " \
    RTT_CTRL_TEXT_BLACK"" \
    RTT_CTRL_BG_BRIGHT_RED"This background is red. " \
    RTT_CTRL_RESET"Normal text again."
);
```

Example 2

```
SEGGER_RTT_printf(0, "%sTime:%s%s %.7d\n",
    RTT_CTRL_RESET,
    RTT_CTRL_BG_BRIGHT_RED,
    RTT_CTRL_TEXT_BRIGHT_WHITE,
    1111111
);

//
// Clear the terminal.
// The first line will not be shown after this command.
//
SEGGER_RTT_WriteString(0, RTT_CTRL_CLEAR);

SEGGER_RTT_printf(0, "%sTime: %s%s%.7d\n",
    RTT_CTRL_RESET,
    RTT_CTRL_BG_BRIGHT_RED,
    RTT_CTRL_TEXT_BRIGHT_WHITE,
    2222222
);
```

3.8 J-Link SWO Viewer

Free-of-charge utility for J-Link. Displays the terminal output of the target using the SWO pin. The stimulus port(s) from which SWO data is received can be chosen by using the port checkboxes 0 to 31. Can be used in parallel with a debugger or stand-alone. This is especially useful when using debuggers which do not come with built-in support for SWO such as most GDB / GDB+Eclipse based debug environments.

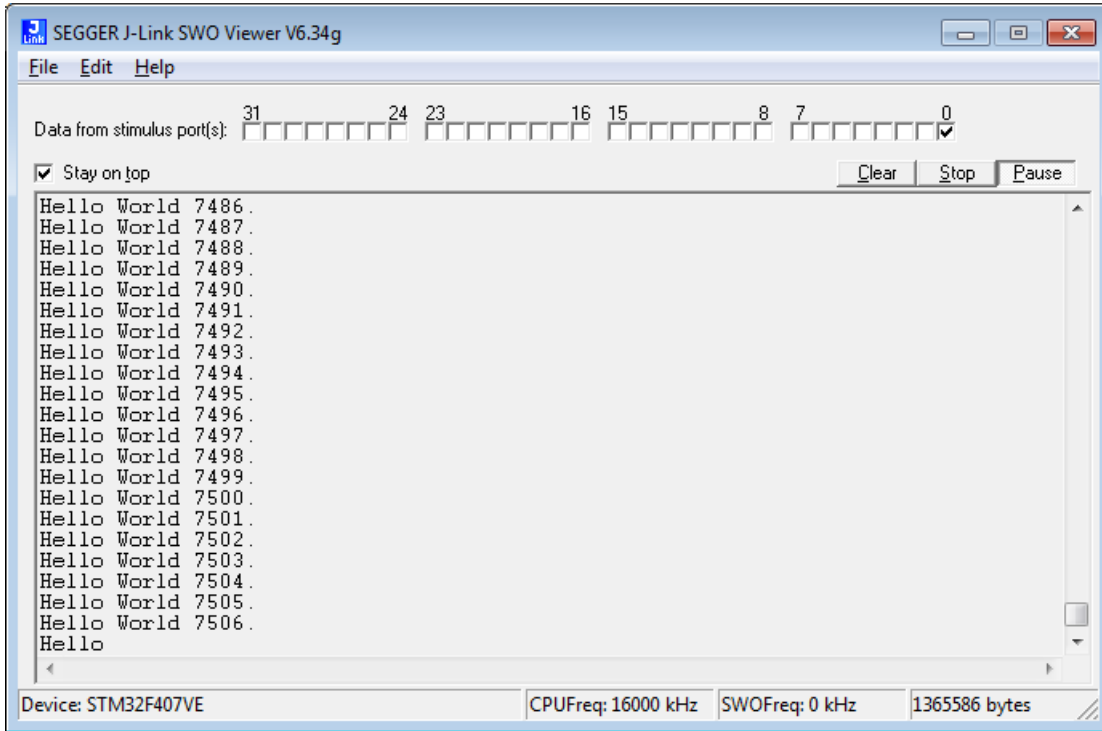

3.8.1 J-Link SWO Viewer CL

Command line-only version of SWO Viewer. All commands available for J-Link SWO Viewer can be used with J-Link SWO Viewer CL. Similar to the GUI Version, J-Link SWO Viewer CL asks for a device name or CPU clock speed at startup to be able to calculate the correct SWO speed or to connect to a running J-Link GDB Server.

Using the syntax given below(see *List of available command line options*), J-Link SWO Viewer CL can be directly started with parameters.

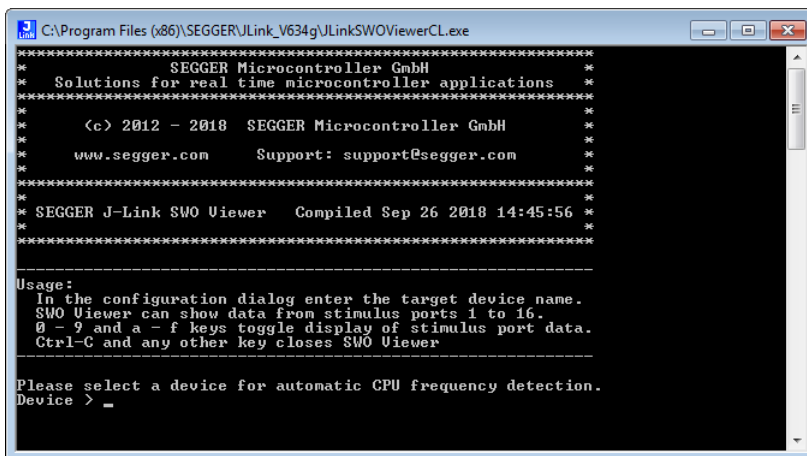

3.8.2 Usage

J-Link SWO Viewer is available via the start menu. It asks for a device name or CPU clock speed at startup to be able to calculate the correct SWO speed or to connect to a running J-Link GDB Server.

Optionally you can select the preferred SWO clock speed from a drop down list. If nothing is selected for SWO clock speed then the debug probe will calculate the optimal value. To populate the drop down list the device needs to be selected or CPU clock speed must be measured once per session.

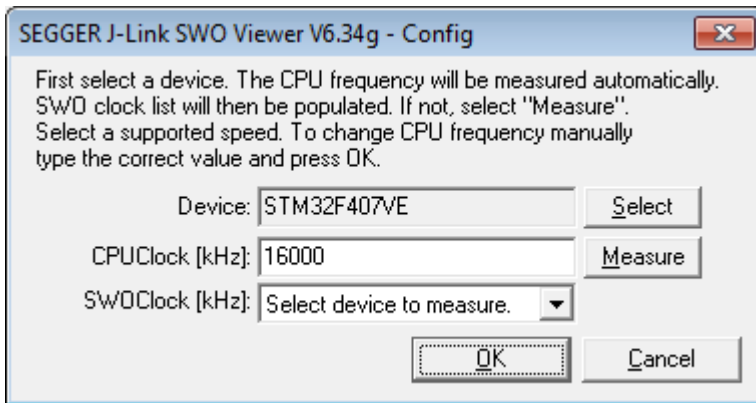

When running in normal mode J-Link SWO Viewer automatically performs the necessary initialization to enable SWO output on the target, in GDB Server mode the initialization has to be done by the debugger. Should you have a target connection already open e.g. a debug session in your IDE we recommend defining the parameters device name, CPU clock frequency and SWO clock frequency via CL to avoid connection errors.

3.8.3 List of available command line options

J-Link SWO Viewer can also be controlled from the command line if used in a automated test environment etc. When passing all necessary information to the utility via command line, the configuration dialog at startup is suppressed. Minimum information needed by J-Link SWO Viewer is the device name (to enable CPU frequency auto detection) or the CPU clock speed. The table below lists the commands accepted by the J-Link SWO View

Command	Description
<code>-cpufreq</code>	Select the CPU frequency.
<code>-device</code>	Select the target device.
<code>-ip</code>	Configure connection settings to IP IPAddress.
<code>-itm mask</code>	Selects a set of itm stimulus ports which should be used to listen to.
<code>-itm port</code>	Selects a itm stimulus port which should be used to listen to.
<code>-outputfile</code>	Print the output of SWO Viewer to the selected file.
<code>-settingsfile</code>	Specify a J-Link settings file.
<code>-swofreq</code>	Select the SWO frequency.
<code>-usb</code>	Configure connection settings to USB S/N.

3.8.3.1 -cpufreq

Defines the current CPU speed in Hz that the CPU is running at. If the CPU is for example running at 96 MHz, the command line should look as below.

Syntax

```
-cpufreq <CPUFreq>
```

Example

```
-cpufreq 96000000
```

3.8.3.2 -device

Select the target device to enable the CPU frequency auto detection of the J-Link DLL. To select a ST STM32F207IG as target device, the command line should look as below. For a list of all supported device names, please refer to:

[List of supported target devices](#)

Syntax

```
-device <DeviceID>
```

Example

```
-device STM32F207IG
```

3.8.3.3 -ip

Selects IP as host interface to connect to J-Link. Default host interface is USB.

Syntax

```
-ip <IPAddr>
```

Example

```
-ip 192.168.1.17
```

3.8.3.4 -itm mask

Defines a set of stimulus ports from which SWO data is received and displayed by SWO Viewer. If itm mask is given, itm port will be ignored.

Syntax

```
-itm mask <Mask>
```

Example

Listen on ports 0 and 2

```
-itm mask 0x5
```

3.8.3.5 -itm port

Defines the stimulus port from which SWO data is received and displayed by the SWO Viewer. Default is stimulus port 0. The command line should look as below.

Syntax

```
-itm port <ITMPortIndex>
```

Example

```
-itm port 0
```

3.8.3.6 -output file

Define a file to which the output of SWO Viewer is printed.

Syntax

```
-output file <PathToFile>
```

Example

```
-outputfile "C:\Temp\Output.log"
```

3.8.3.7 -settingsfile

Select a J-Link settings file to use for the target device.

Syntax

```
-settingsfile <PathToFile>
```

Example

```
-settingsfile "C:\Temp\Settings.jlink"
```

3.8.3.8 -swofreq

Defines the SWO frequency that shall be used by J-Link SWO Viewer for sampling SWO data. Usually not necessary to define since optimal SWO speed is calculated automatically based on the CPU frequency and the capabilities of the connected J-Link. If the targeted SWO speed is 6 MHz the command line should look as follows.

Syntax

```
-swofreq <SWOFreq>
```

Example

```
-swofreq 6000000
```

3.8.3.9 -usb

Configures the connection settings according to defined USB S/N. Usually not necessary to define if only one debug device is connected to the PC.

Syntax

```
-usb <S/N>
```

Example

```
-usb 01234567
```

3.8.4 Configure SWO output after device reset

In some situations it might happen that the target application is reset and it is desired to log the SWO output of the target after reset during the booting process. For such situations, the target application itself needs to initialize the CPU for SWO output, since the SWO Viewer is not restarted but continuously running.

Example code for enabling SWO out of the target application

```
#define ITM_ENA    (*(volatile unsigned int*)0xE000E00) // ITM Enable
#define ITM_TPR    (*(volatile unsigned int*)0xE000E40) // Trace Privilege
// Register
#define ITM_TCR    (*(volatile unsigned int*)0xE000E80) // ITM Trace Control Reg.
#define ITM_LSR    (*(volatile unsigned int*)0xE000FB0) // ITM Lock Status
// Register
#define DHCSR      (*(volatile unsigned int*)0xE00EDF0) // Debug register
#define DEMCR      (*(volatile unsigned int*)0xE00EDFC) // Debug register
#define TPIU_ACPR  (*(volatile unsigned int*)0xE0040010) // Async Clock
// prescaler register
#define TPIU_SPPR  (*(volatile unsigned int*)0xE00400F0) // Selected Pin Protocol
// Register
```



```

#define DWT_CTRL (*(volatile unsigned int*)0xE0001000) // DWT Control Register
#define FFCR      (*(volatile unsigned int*)0xE0040304) // Formatter and flush
                                                         // Control Register
U32 _ITMPort = 0; // The stimulus port from which SWO data is received
                 // and displayed.
U32 TargetDiv = 1; // Has to be calculated according to
                  // the CPU speed and the output baud rate

static void _EnableSWO() {
    U32 StimulusRegs;
    //
    // Enable access to SWO registers
    //
    DEMCR |= (1 << 24);
    ITM_LSR = 0xC5ACCE55;
    //
    // Initially disable ITM and stimulus port
    // To make sure that nothing is transferred via SWO
    // when changing the SWO prescaler etc.
    //
    StimulusRegs = ITM_ENA;
    StimulusRegs &= ~(1 << _ITMPort);
    ITM_ENA = StimulusRegs; // Disable ITM stimulus port
    ITM_TCR = 0; // Disable ITM
    //
    // Initialize SWO (prescaler, etc.)
    //
    TPIU_SPPR = 0x00000002; // Select NRZ mode
    TPIU_ACPR = TargetDiv - 1; // Example: 72/48 = 1,5 MHz
    ITM_TPR = 0x00000000;
    DWT_CTRL = 0x400003FE;
    FFCR = 0x00000100;
    //
    // Enable ITM and stimulus port
    //
    ITM_TCR = 0x1000D; // Enable ITM
    ITM_ENA = StimulusRegs | (1 << _ITMPort); // Enable ITM stimulus port
}

```

3.8.5 Target example code for terminal output

```

/*****
 *                               SEGGER Microcontroller GmbH                               *
 *   Solutions for real time microcontroller applications                               *
 *****/
 *
 *   (c) 1995 - 2018 SEGGER Microcontroller GmbH                                       *
 *
 *   www.segger.com Support: support@segger.com                                       *
 *****/

-----
File      : SWO.c
Purpose   : Simple implementation for output via SWO for Cortex-M processors.
           It can be used with any IDE. This sample implementation ensures
           that output via SWO is enabled in order to guarantee that the
           application does not hang.

----- END-OF-HEADER -----
*/

/*****
 *
 *   Prototypes (to be placed in a header file such as SWO.h)
 */

```

```

void SWO_PrintChar (char c);
void SWO_PrintString(const char *s);

/*****
*
*     Defines for Cortex-M debug unit
*/
#define ITM_STIM_U32 (*(volatile unsigned int*)0xE0000000) // STIM word access
#define ITM_STIM_U8  (*(volatile      char*)0xE0000000) // STIM Byte access
#define ITM_ENA      (*(volatile unsigned int*)0xE0000E00) // ITM Enable Register
#define ITM_TCR      (*(volatile unsigned int*)0xE0000E80) // ITM Trace Control
                                                           // Register

/*****
*
*     SWO_PrintChar()
*
* Function description
* Checks if SWO is set up. If it is not, return,
* to avoid program hangs if no debugger is connected.
* If it is set up, print a character to the ITM_STIM register
* in order to provide data for SWO.
* Parameters
* c:   The character to be printed.
* Notes
* Additional checks for device specific registers can be added.
*/
void SWO_PrintChar(char c) {
    //
    // Check if ITM_TCR.ITMENA is set
    //
    if ((ITM_TCR & 1) == 0) {
        return;
    }
    //
    // Check if stimulus port is enabled
    //
    if ((ITM_ENA & 1) == 0) {
        return;
    }
    //
    // Wait until STIMx is ready,
    // then send data
    //
    while ((ITM_STIM_U8 & 1) == 0);
    ITM_STIM_U8 = c;
}

/*****
*
*     SWO_PrintString()
*
* Function description
* Print a string via SWO.
*/
void SWO_PrintString(const char *s) {
    //
    // Print out character per character
    //
    while (*s) {
        SWO_PrintChar(*s++);
    }
}

```

3.9 SWO Analyzer

SWO Analyzer (`SWOAnalyzer.exe`) is a tool that analyzes SWO output. Status and summary of the analysis are output to standard out, the details of the analysis are stored in a file.

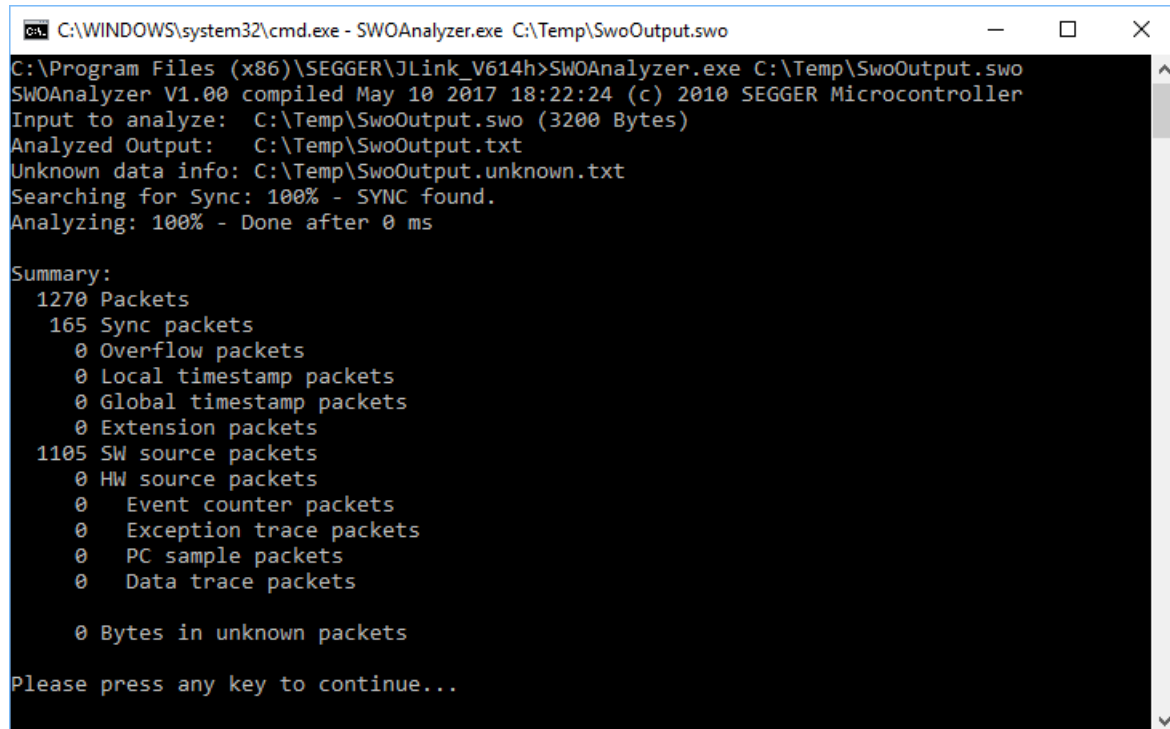

```
C:\WINDOWS\system32\cmd.exe - SWOAnalyzer.exe C:\Temp\SwoOutput.swo
C:\Program Files (x86)\SEGGER\JLink_V614h>SWOAnalyzer.exe C:\Temp\SwoOutput.swo
SWOAnalyzer V1.00 compiled May 10 2017 18:22:24 (c) 2010 SEGGER Microcontroller
Input to analyze: C:\Temp\SwoOutput.swo (3200 Bytes)
Analyzed Output: C:\Temp\SwoOutput.txt
Unknown data info: C:\Temp\SwoOutput.unknown.txt
Searching for Sync: 100% - SYNC found.
Analyzing: 100% - Done after 0 ms

Summary:
 1270 Packets
   165 Sync packets
     0 Overflow packets
     0 Local timestamp packets
     0 Global timestamp packets
     0 Extension packets
  1105 SW source packets
     0 HW source packets
     0 Event counter packets
     0 Exception trace packets
     0 PC sample packets
     0 Data trace packets

     0 Bytes in unknown packets

Please press any key to continue...
```

Usage

`SWOAnalyzer.exe <SWOfile>` This can be achieved by simply dragging the SWO output file created by the J-Link DLL onto the executable.

Creating an SWO output file

In order to create the SWO output file, which is the input file for the SWO Analyzer, the J-Link config file needs to be modified. It should contain the following lines:

```
[SWO]
SWOLogFile="C:\TestSWO.dat"
```

3.10 JTAGLoad (Command line tool)

JTAGLoad is a tool that can be used to open and execute an svf (Serial vector format) file for JTAG boundary scan tests. The data in the file will be sent to the target via J-Link / J-Trace.

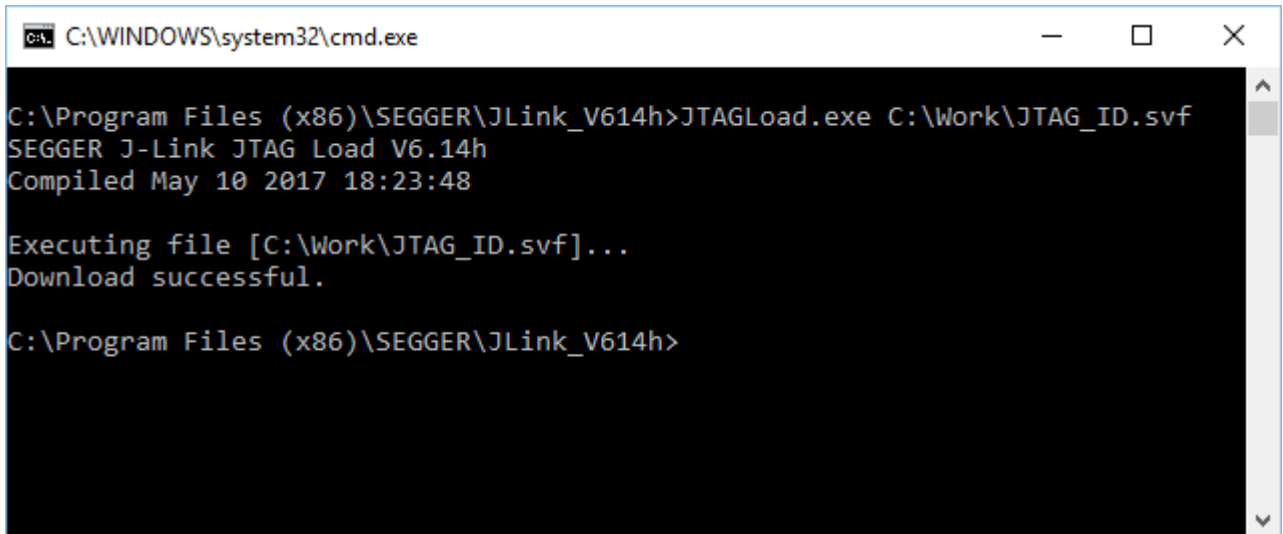

```

C:\WINDOWS\system32\cmd.exe

C:\Program Files (x86)\SEGGER\JLink_V614h>JTAGLoad.exe C:\Work\JTAG_ID.svf
SEGGER J-Link JTAG Load V6.14h
Compiled May 10 2017 18:23:48

Executing file [C:\Work\JTAG_ID.svf]...
Download successful.

C:\Program Files (x86)\SEGGER\JLink_V614h>

```

SVF is a standard format for boundary scan vectors to be used with different tools and targets. SVF files contain human-readable ASCII SVF statements consisting of an SVF command, the data to be sent, the expected response, a mask for the response or additional information.

JTAGLoad supports following SVF commands:

- ENDDR
- ENDIR
- FREQUENCY
- HDR
- HIR
- RUNTEST
- SDR
- SIR
- STATE
- TDR
- TIR

A simple SVF file to read the JTAG ID of the target can look like following:

```

! Set JTAG frequency
FREQUENCY 12000000HZ;
! Configure scan chain
! For a single device in chain, header and trailer data on DR and IR are 0
! Set TAP to IDLE state
STATE IDLE;
! Configure end state of DR and IR after scan operations
ENDDR IDLE;
ENDIR IDLE;
! Start of test
! 32 bit scan on DR, In: 32 0 bits, Expected out: Device ID (0x0BA00477)
SDR 32 TDI (0) TDO (0BA00477) MASK (0FFFFFFF);
! Set TAP to IDLE state
STATE IDLE;
! End of test

```

SVD files allow even more complex tasks, basically everything which is possible via JTAG and the devices in the scan chain, like configuring an FPGA or loading data into memory.

Available command lines:

|| Command | Description || /? | Shows how to call JTAGLoad. || -NoAutoExit | Prevents JTAGLoad from auto exiting.

3.11 J-Link RDI (Remote Debug Interface)

The J-Link RDI software is a remote debug interface for J-Link. It makes it possible to use J-Link with any RDI compliant debugger. The main part of the software is an RDI-compliant DLL, which needs to be selected in the debugger. here are two additional features available which build on the RDI software foundation. Each additional feature requires an RDI license in addition to its own license. Evaluation licenses are available free of charge. For further information go to our website or contact us directly.

Note

The RDI software (as well as flash breakpoints and flash downloads) do not require a license if the target device is an LPC2xxx. In this case the software verifies that the target device is actually an LPC 2xxx and have a device-based license.

3.11.1 Flash download and flash breakpoints

Flash download and flash breakpoints are supported by J-Link RDI. For more information about flash download and flash breakpoints, please refer to J-Link RDI User's Guide (UM08004) , chapter Flash download and chapter Breakpoints in flash memory .

3.12 Processor specific tools

The J-Link Software and Documentation Package includes some tools which support processor specific functionalities, like unlocking a device.

3.12.1 J-Link STR91x Commander (Command line tool)

J-Link STR91x Commander (`JLinkSTR91x.exe`) is a tool that can be used to configure STR91x cores. It permits some STR9 specific commands like:

- Set the configuration register to boot from bank 0 or 1.
- Erase flash sectors.
- Read and write the OTP sector of the flash.
- Write-protect single flash sectors by setting the sector protection bits.
- Prevent flash from communicate via JTAG by setting the security bit.

All of the actions performed by the commands, excluding writing the OTP sector and erasing the flash, can be undone. This tool can be used to erase the flash of the controller even if a program is in flash which causes the CPU core to stall.

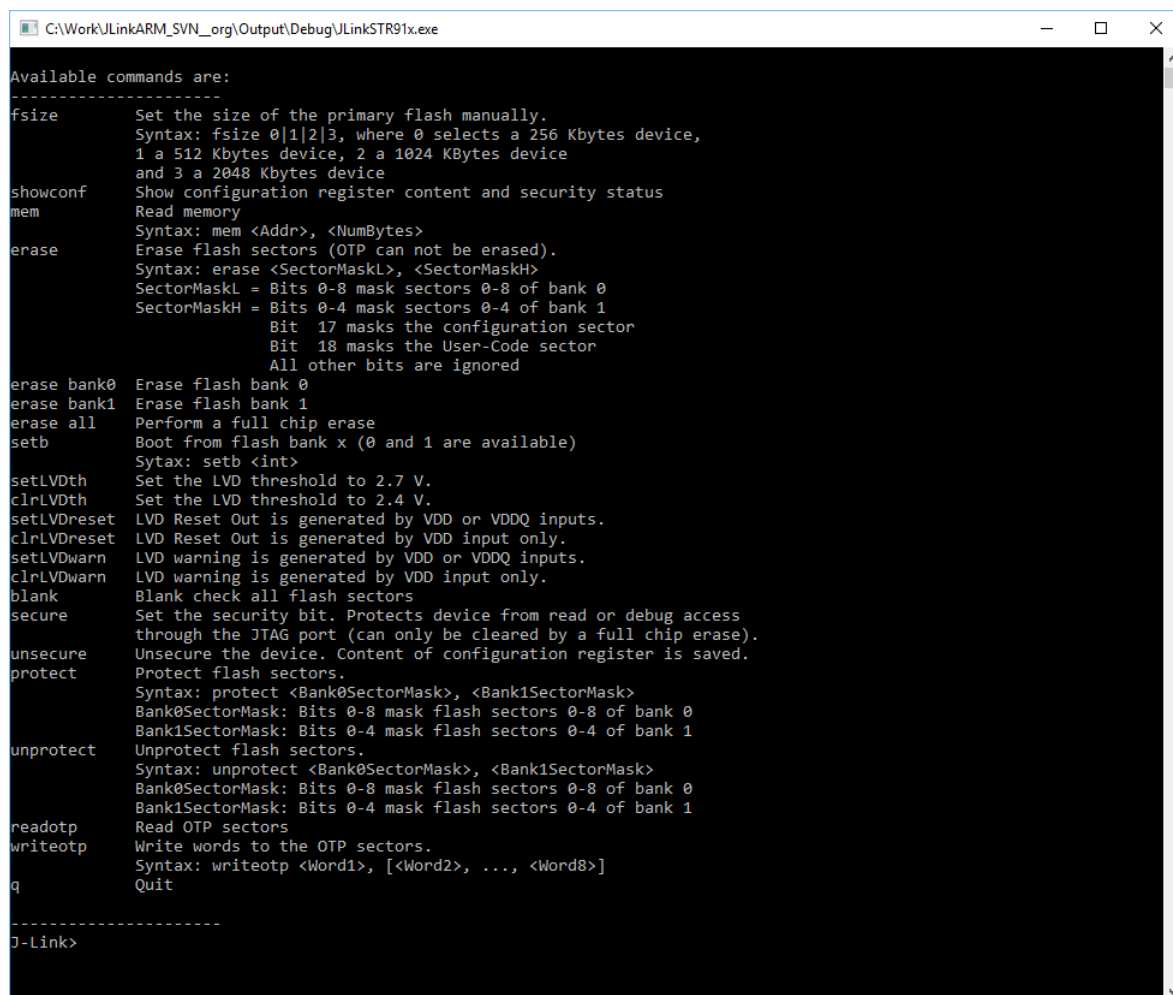

```

C:\Work\JLinkARM_SVN_org\Output\Debug\JLinkSTR91x.exe
Available commands are:
-----
fsize      Set the size of the primary flash manually.
           Syntax: fsize 0|1|2|3, where 0 selects a 256 Kbytes device,
           1 a 512 Kbytes device, 2 a 1024 Kbytes device
           and 3 a 2048 Kbytes device
showconf   Show configuration register content and security status
mem        Read memory
           Syntax: mem <Addr>, <NumBytes>
erase      Erase flash sectors (OTP can not be erased).
           Syntax: erase <SectorMaskL>, <SectorMaskH>
           SectorMaskL = Bits 0-8 mask sectors 0-8 of bank 0
           SectorMaskH = Bits 0-4 mask sectors 0-4 of bank 1
                   Bit 17 masks the configuration sector
                   Bit 18 masks the User-Code sector
                   All other bits are ignored
erase bank0 Erase flash bank 0
erase bank1 Erase flash bank 1
erase all   Perform a full chip erase
setb       Boot from flash bank x (0 and 1 are available)
           Sytax: setb <int>
setLVDth   Set the LVD threshold to 2.7 V.
clrLVDth   Set the LVD threshold to 2.4 V.
setLVDreset LVD Reset Out is generated by VDD or VDDQ inputs.
clrLVDreset LVD Reset Out is generated by VDD input only.
setLVDwarn LVD warning is generated by VDD or VDDQ inputs.
clrLVDwarn LVD warning is generated by VDD input only.
blank      Blank check all flash sectors
secure     Set the security bit. Protects device from read or debug access
           through the JTAG port (can only be cleared by a full chip erase).
unsecure   Unsecure the device. Content of configuration register is saved.
protect    Protect flash sectors.
           Syntax: protect <Bank0SectorMask>, <Bank1SectorMask>
           Bank0SectorMask: Bits 0-8 mask flash sectors 0-8 of bank 0
           Bank1SectorMask: Bits 0-4 mask flash sectors 0-4 of bank 1
unprotect  Unprotect flash sectors.
           Syntax: unprotect <Bank0SectorMask>, <Bank1SectorMask>
           Bank0SectorMask: Bits 0-8 mask flash sectors 0-8 of bank 0
           Bank1SectorMask: Bits 0-4 mask flash sectors 0-4 of bank 1
readotp    Read OTP sectors
writeotp   Write words to the OTP sectors.
           Syntax: writeotp <Word1>, [<Word2>, ..., <Word8>]
q          Quit
-----
J-Link>

```

When starting the STR91x commander, a command sequence will be performed which brings MCU into Turbo Mode.

“While enabling the Turbo Mode, a dedicated test mode signal is set and controls the GPIOs in output. The IOs are maintained in this state until a next JTAG instruction is sent.” (ST Microelectronics)

Enabling Turbo Mode is necessary to guarantee proper function of all commands in the STR91x Commander.

Commands

Command	Description
fsize	Set the size of the primary flash manually. Syntax: fsize 0 1 2 3, where 0 selects a 256 Kbytes device, 1 a 512 Kbytes device, 2 a 1024 Kbytes device and 3 a 2048 Kbytes device
showconf	Show configuration register content and security status
mem	Read memory Syntax: mem <Addr>, <NumBytes>
erase	Erase flash sectors (OTP can not be erased). Syntax: erase <SectorMaskL>, <SectorMaskH> SectorMaskL = Bits 0-%d mask sectors 0-%d of bank 0 SectorMaskH = Bits 0-%d mask sectors 0-%d of bank 1 Bit 17 masks the configuration sector Bit 18 masks the User-Code sector All other bits are ignored
erase bank0	Erase flash bank 0
erase bank1	Erase flash bank 1
erase all	Perform a full chip erase
setb	Boot from flash bank x (0 and 1 are available) Syntax: setb <int>
setLVDth	Set the LVD threshold to 2.7 V.
clrLVDth	Set the LVD threshold to 2.4 V.
setLVDreset	LVD Reset Out is generated by VDD or VDDQ inputs.
clrLVDreset	LVD Reset Out is generated by VDD input only.
setLVDwarn	LVD warning is generated by VDD or VDDQ inputs.
clrLVDwarn	LVD warning is generated by VDD input only.
blank	Blank check all flash sectors
secure	Set the security bit. Protects device from read or debug access through the JTAG port (can only be cleared by a full chip erase).
unsecure	Unsecure the device. Content of configuration register is saved.
protect	Protect flash sectors. Syntax: protect <Bank0SectorMask>, <Bank1SectorMask> Bank0SectorMask: Bits 0-%d mask flash sectors 0-%d of bank 0 Bank1SectorMask: Bits 0-%d mask flash sectors 0-%d of bank 1
unprotect	Unprotect flash sectors. Syntax: unprotect <Bank0SectorMask>, <Bank1SectorMask> Bank0SectorMask: Bits 0-%d mask flash sectors 0-%d of bank 0 Bank1SectorMask: Bits 0-%d mask flash sectors 0-%d of bank 1
readotp	Read OTP sectors
wroteotp	Write words to the OTP sectors. Syntax: wroteotp <Word1>, [<Word2>, ..., <Word8>]
q	Quit

Command line options

J-Link STR91x Commander can be started with different command line options for test and automation purposes. In the following, the command line options which are available for J-Link Commander are explained. All command line options are case insensitive.

Command	Explanation
<code>-CommandFile</code>	Passes a CommandFile to J-Link
<code>-IP</code>	Selects IP as host interface
<code>-USB</code>	Connects to a J-Link with a specific S/N over USB
<code>-IRPre</code>	Scan-Chain Configuration
<code>-IRPost</code>	Scan-Chain Configuration
<code>-DRPre</code>	Scan-Chain Configuration
<code>-DRPost</code>	Scan-Chain Configuration

3.12.1.1 -CommandFile

Selects a command file and starts J-Link STR91x Commander in batch mode. The batch mode of J-Link STR91x Commander is similar to the execution of a batch file. The command file is parsed line by line and one command is executed at a time.

Syntax

```
-CommandFile <CommandFilePath>
```

Example

See *Using J-Link Command Files* .

3.12.1.2 -DRPre, -DRPost, -IRPre and -IRPost (Scan-Chain Configuration)

STR91x allows to configure a specific scan-chain via command-line. To use this feature four command line options have to be specified in order to allow a proper connection to the proper device. In case of passing an incomplete configuration, the utility tries to auto-detect.

Syntax

```
-DRPre <DRPre>
-DRPost <DRPost>
-IRPre <IRPre>
-IRPost <IRPost>
```

Example

```
JLinkSTR91x.exe -DRPre 1 -DRPost 4 -IRPre 16 -IRPost 20
```

3.12.1.3 -IP

Selects IP as host interface to connect to J-Link. Default host interface is USB.

Syntax

```
-IP <IPAddr>
```

Example

```
JLinkSTR91x.exe -IP 192.168.1.17
```

Additional information

To select from a list of all available emulators on Ethernet, please use * as <IPAddr> .

3.12.1.4 -USB

Connect to a J-Link with a specific serial number via USB. Useful if multiple J-Links are connected to the same PC and multiple instances of J-Link Commander shall run and each connects to another J-Link.

Syntax

```
-USB <SerialNo>
```

Example

```
JLinkSTR91x.exe -USB 580011111
```

3.12.2 J-Link STM32 Unlock (Command line tool)

J-Link STM32 Unlock (`JLinkSTM32.exe`) is a free command line tool which can be used to disable the hardware watchdog of STM32 devices which can be activated by programming the option bytes. Moreover the J-Link STM32 Commander unsecures a read-protected STM32 device by re-programming the option bytes.

Note

Unprotecting a secured device or will cause a mass erase of the flash memory.

```

C:\Program Files (x86)\SEGGER\JLink_V614h\JLinkSTM32.exe
SEGGER J-Link Unlock tool for STM32 devices
Compiled May 10 2017 18:23:34
(c) 2009-2015 SEGGER Microcontroller GmbH & Co. KG, www.segger.com
Solutions for real time microcontroller applications

Options:
[0] Exit
[1] STM32F0xxxx
[2] STM32F1xxxx
[3] STM32F2xxxx
[4] STM32F3xxxx
[5] STM32F4xxxx
[6] STM32F74xxx, STM32F75xxx
[7] STM32F76xxx, STM32F77xxx
[8] STM32L1xxxx
[9] STM32L4x6xx

Please select the correct device family: 5
Connecting to J-Link via USB...O.K.
Using SWD as target interface.
Target interface speed: 1000 kHz.
VTarget = 3.298V
Reset target...O.K.
Reset option bytes (may take app. 20 seconds)...O.K.
Press any key to exit.

```

Command Line Options

Command line option	Explanation
<code>-IP</code>	Selects IP as host interface to connect to J-Link. Default host interface is USB.
<code>-SelectEmuBySN</code>	Connects to a J-Link with a specific S/N over USB
<code>-Speed</code>	Starts the J-Link STM32 Unlock Utility with a given initial interface speed.
<code>-SetPowerTarget</code>	Enables target power supply via pin 19.
<code>-SetDeviceFamily</code>	Specifies a device family

Command line option	Explanation
-Exit	J-Link STM32 Unlock will close automatically

3.12.2.1 -IP

Selects IP as host interface to connect to J-Link. Default host interface is USB.

Syntax

```
-IP <IPAddr>
```

Example

```
JLinkSTM32.exe -IP 192.168.1.17
```

Note

To select from a list of all available emulators on Ethernet, please use * as <IPAddr>.

3.12.2.2 -SelectEmuBySN

Connect to a J-Link with a specific serial number via USB. Useful if multiple J-Links are connected to the same PC.

Syntax

```
-SelectEmuBySN <SerialNo>
```

Example

```
JLinkSTM32.exe -SelectEmuBySN 580011111
```

3.12.2.3 -Speed

Starts J-Link STM32 Unlock Utility with a given initial speed. Available parameters are "adaptive", "auto" or a freely selectable integer value in kHz. It is recommended to use either a fixed speed or, if it is available on the target, adaptive speeds. Default interface speed is 1000 kHz.

Syntax

```
-Speed <Speed_kHz>
```

Example

```
-Speed 1000
```

3.12.2.4 -SetPowerTarget

The connected debug probe will power the target via pin 19 of the debug connector.

Syntax

```
-SetPowerTarget <Mode>
```

Example

```
JLinkSTM32.exe -SetPowerTarget 1 // Target power will be set
```

3.12.2.5 -SetDeviceFamily

This command allows to specify a device family, so that no user input is required to start the unlocking process.

Syntax

```
-SetDeviceFamily <Parameter>
```

Parameter

There are two different options to specify the device family to be used:

- Pass the list index from the list which shows all supported families on start up
- Pass the defined device name

ID	Device
1	STM32F0xxxx
2	STM32F1xxxx
3	STM32F2xxxx
4	STM32F3xxxx
5	STM32F4xxxx
6	STM32F72_F73xxx
7	STM32F74_F75xxx
8	STM32F76_F77xxx
9	STM32L0xxxx
10	STM32L1xxxx
11	STM32L4x6xx

Example

```
JLinkSTM32.exe -SetDeviceFamily 10 // Selects STM32L1 series
JLinkSTM32.exe -SetDeviceFamily STM32F2xxxx // Selects STM32F2 series
```

3.12.2.6 -Exit

In general, the J-Link STM32 utility waits at the end of the unlock process for any user input before application closes. This option allows to skip this step, so that the utility closes automatically.

Syntax

```
-Exit <Mode>
```

Example

```
JLinkSTM32.exe -Exit 1 // J-Link STM32 utility closes automatically
```

3.13 J-Link Software Developer Kit (SDK)

The J-Link Software Developer Kit is needed if you want to write your own program with J-Link / J-Trace. The J-Link DLL is a standard Windows DLL typically used from C programs (Visual Basic or Delphi projects are also possible). It makes the entire functionality of J-Link / J-Trace available through its exported functions, such as halting/stepping the CPU core, reading/writing CPU and ICE registers and reading/writing memory. Therefore it can be used in any kind of application accessing a CPU core. The standard DLL does not have API functions for flash programming. However, the functionality offered can be used to program flash. In this case, a flash loader is required. The table below lists some of the included files and their respective purpose.

Further information can be found on the SEGGER website:

[J-Link SDK](#)

The J-Link SDK requires an additional license and is available upon request from www.segger.com.

Chapter 4

J-Link GDB Server

The GNU Project Debugger (GDB) is a freely available and open source debugger. It can be used in command line mode, but is also integrated in many IDEs like emIDE or Eclipse.

J-Link GDB Server is a remote server for GDB making it possible for GDB to connect to and communicate with the target device via J-Link. GDB Server and GDB communicate via a TCP/IP connection, using the standard GDB remote protocol. GDB Server receives the GDB commands, does the J-Link communication and replies with the answer to GDB.

With J-Link GDB Server debugging in ROM and Flash of the target device is possible and the Unlimited Flash Breakpoints can be used. It also comes with some functionality not directly implemented in the GDB. These can be accessed via monitor commands, sent directly via GDB, too.

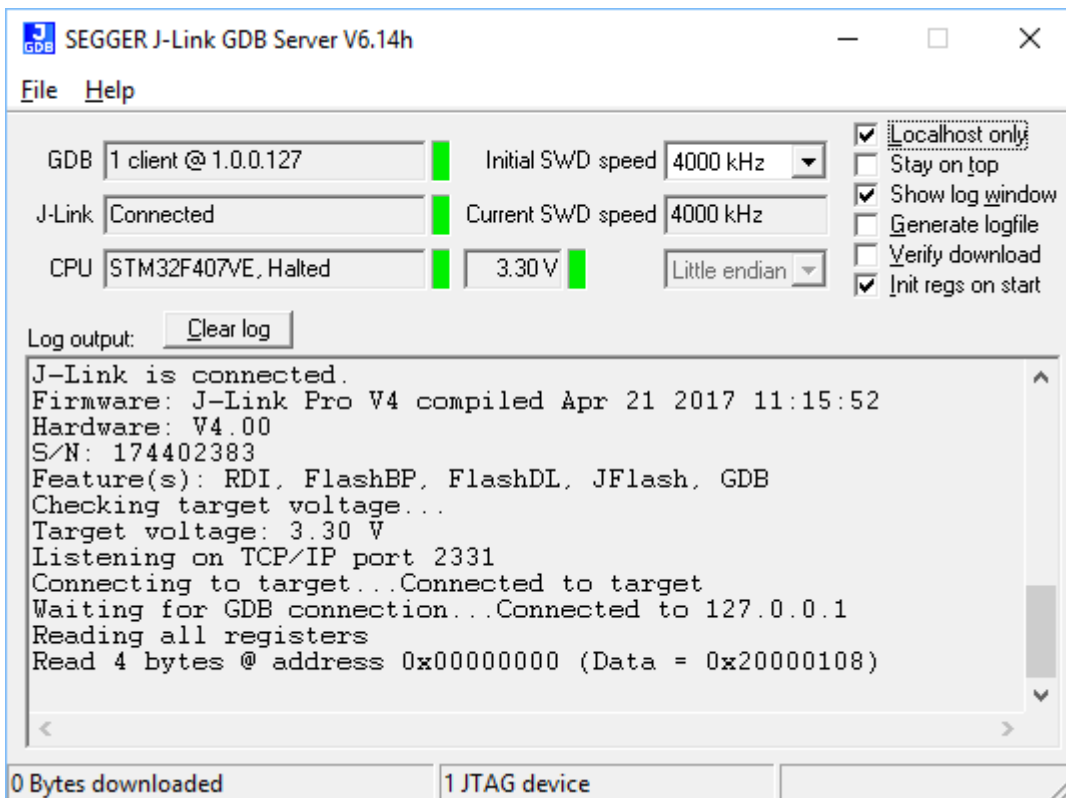

J-Link GDB Server

The GNU Project Debugger (GDB) is a freely available debugger, distributed under the terms of the GPL. The latest Unix version of the GDB is freely available from the GNU committee under: <http://www.gnu.org/software/gdb/download/>

J-Link GDB Server is distributed free of charge.

4.1 J-Link GDB Server CL (Windows, Linux, Mac)

J-Link GDB Server CL is a commandline-only version of the GDB Server. The command line version is part of the Software and Documentation Package and also included in the Linux and MAC versions.

Except for the missing GUI, J-Link GDB Server CL is identical to the normal version. All sub-chapters apply to the command line version, too.

4.2 Debugging with J-Link GDB Server

With J-Link GDB Server programs can be debugged via GDB directly on the target device like a normal application. The application can be loaded into RAM or flash of the device.

Before starting GDB Server make sure a J-Link and the target device are connected.

4.2.1 Setting up GDB Server GUI version

The GUI version of GDB Server is part of the Windows J-Link Software Package (JLinkGDBServer.exe).

When starting GDB Server a configuration dialog pops up, letting you select the needed configurations to connect to J-Link and the target.



J-Link GDB Server: Configuration

All configurations can optionally be given in the command line options.

Note

To make sure the connection to the target device can be established correctly, the device, as well as the interface and interface speed have to be given on start of GDB Server, either via command line options or the configuration dialog. If the target device option (-device) is given, the configuration dialog will not pop up.

4.2.2 Setting up GDB Server CL version

The command line version of GDB Server is part of the J-Link Software Package for all supported platforms. On Windows its name is JLinkGDBServerCL.exe, on Linux and Mac it is JLinkGDBServer.

Starting GDB Server on Windows

To start GDB Server CL on Windows, open the 'Run' prompt (Windows-R) or a command terminal (cmd) and enter
 <PathToJLinkSoftware>\JLinkGDBServerCL.exe <CommandLineOptions>.

Starting GDB Server on Linux / Mac

To start GDB Server CL on Linux / Mac, open a terminal and call JLinkGDBServer <CommandLineOptions>

Command Line Options

When using GDB Server CL, at least the mandatory command line options have to be given. Additional command line options can be given to change the default behavior of GDB Server. For more information about the available command line options, please refer to *Command line options* .

4.2.3 GDB Server user interface

The J-Link GDB Server's user interface shows information about the debugging process and the target and allows to configure some settings during execution.

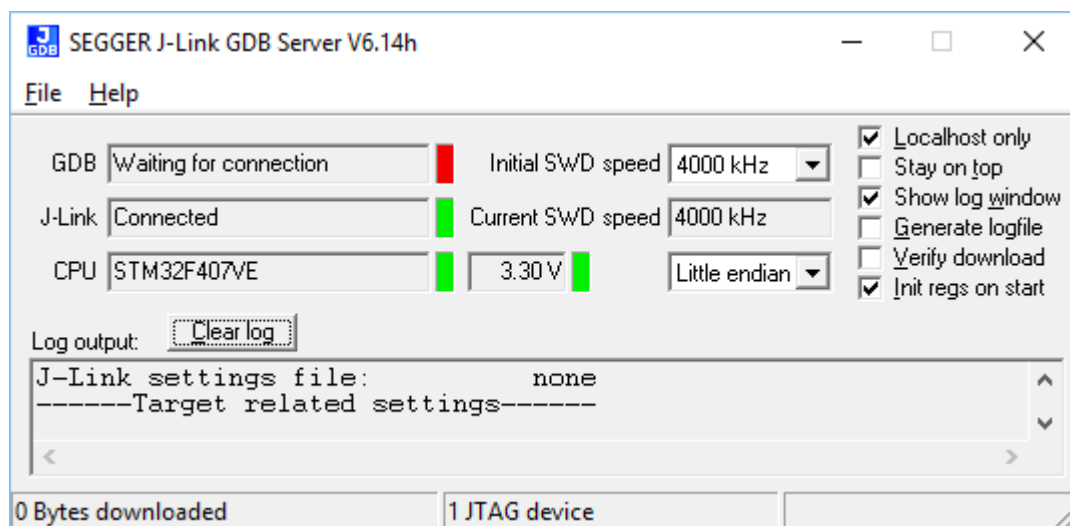

J-Link GDB Server: UI

It shows following information:

- The IP address of host running debugger.
- Connection status of J-Link.
- Information about the target core.
- Measured target voltage.
- Bytes that have been downloaded.
- Status of target.
- Log output of the GDB Server (optional, if **Show log window** is checked).
- Initial and current target interface speed.
- Target endianness.

These configurations can be made from inside GDB Server:

- Localhost only: If checked only connections from 127.0.0.1 are accepted.
- Stay on top
- Show log window.
- Generate logfile: If checked, a log file with the GDB <-> GDB Server <-> J-Link communication will be created.
- Verify download: If checked, the memory on the target will be verified after download.
- Init regs on start: If checked, the register values of the target will be set to a reasonable value before on start of GDB Server.

4.2.4 Running GDB from different programs

We assume that you already have a solid knowledge of the software tools used for building your application (assembler, linker, C compiler) and especially the debugger and the debugger frontend of your choice. We do not answer questions about how to install and use the chosen toolchain.

GDB is included in many IDEs and most commonly used in connection with the GCC compiler toolchain. This chapter shows how to configure some programs to use GDB and connect to GDB Server. For more information about any program using GDB, please refer to its user manual.

emIDE

emIDE is a full-featured, free and open source IDE for embedded development including support for debugging with J-Link.

To connect to GDB Server with emIDE, the GDB Server configurations need to be set in the project options at Project -> Properties... -> Debugger. Select the target device you are using, the target connection, endianness and speed and enter the additional GDB start commands. The typically required GDB commands are:

```
#Initially reset the target
monitor reset
#Load the application
load
```

Other commands to set up the target (e.g. Set PC to RAM, initialize external flashes) can be entered here, too.

emIDE will automatically start GDB Server on start of the debug session. If it does not, or an older version of GDB Server starts, in emIDE click on JLink -> Run the JLink-plugin configuration.

The screenshot below shows a debug session in IDE. For download and more information about emIDE, please refer to <http://emide.org> .

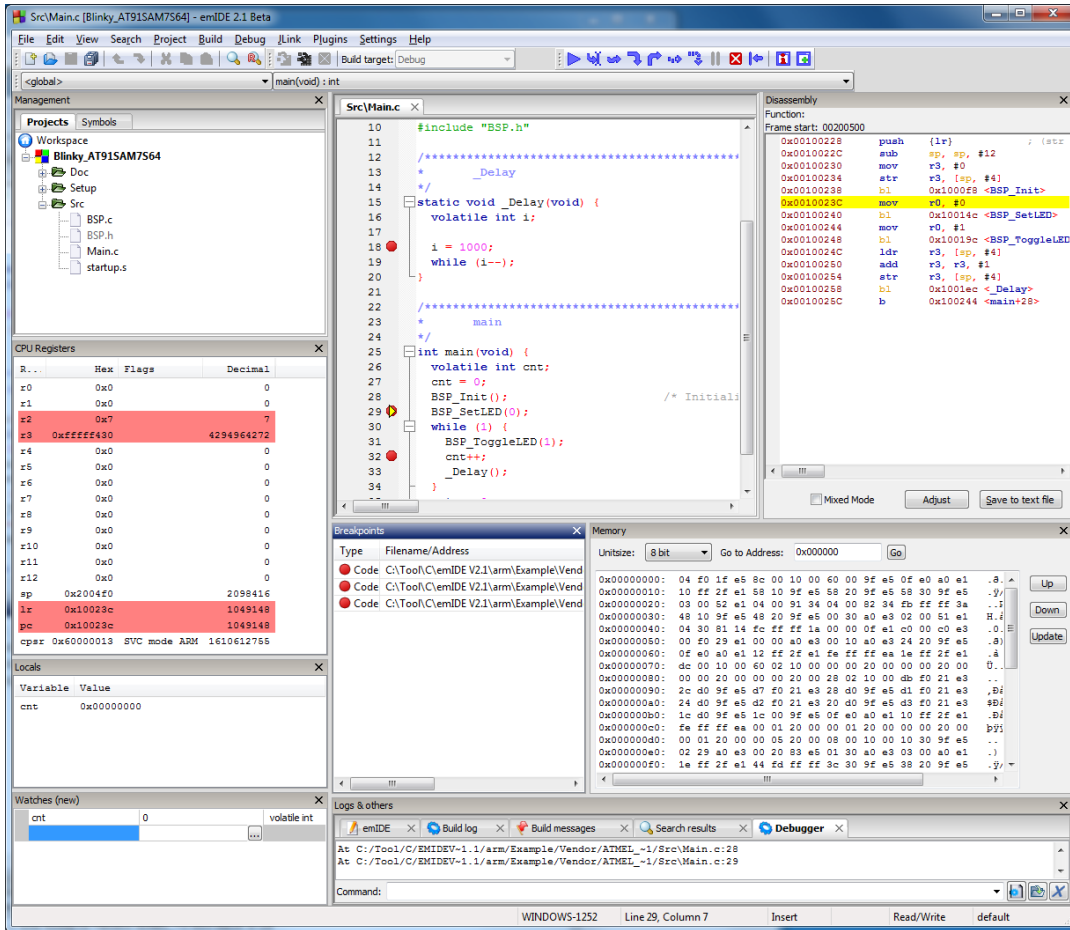

Console

GDB can be used stand-alone as a console application.

To connect GDB to GDB Server enter `target remote localhost:2331` into the running GDB. Within GDB all GDB commands and the remote monitor commands are available. For more information about debugging with GDB refer to its online manual available at <http://sourceware.org/gdb/current/onlinedocs/gdb/>.

A typical startup of a debugging session can be like:

```
(gdb) file C:/temp/Blinky.elf
Reading symbols from C:/temp/Blinky.elf...done.
(gdb) target remote localhost:2331
Remote debugging using localhost:2331
0x00000000 in ?? ()
(gdb) monitor reset
Resetting target
(gdb) load
Loading section .isr_vector, size 0x188 lma 0x8000000
Loading section .text, size 0x568 lma 0x8000188
Loading section .init_array, size 0x8 lma 0x80006f0
Loading section .fini_array, size 0x4 lma 0x80006f8
Loading section .data, size 0x428 lma 0x80006fc
Start address 0x8000485, load size 2852
Transfer rate: 146 KB/sec, 570 bytes/write.
(gdb) break main
Breakpoint 1 at 0x800037a: file Src/main.c, line 38.
(gdb) continue
Continuing.
Breakpoint 1, main () at Src/main.c:38
38 Cnt = 0;
(gdb)
```

Eclipse (CDT)

Eclipse is an open source platform-independent software framework, which has typically been used to develop integrated development environment (IDE). Therefore Eclipse can be used as C/C++ IDE, if you extend it with the CDT plug-in (<http://www.eclipse.org/cdt/>).

CDT means "C/C++ Development Tooling" project and is designed to use the GDB as default debugger and works without any problems with the GDB Server. Refer to <http://www.eclipse.org> for detailed information about Eclipse.

Note

We only support problems directly related to the GDB Server. Problems and questions related to your remaining toolchain have to be solved on your own.

4.3 Supported remote (monitor) commands

J-Link GDB Server comes with some functionalities which are not part of the standard GDB. These functions can be called either via a gdbinit file passed to GDB Server or via monitor commands passed directly to GDB, forwarding them to GDB Server.

To indicate to GDB to forward the command to GDB Server 'monitor' has to be prepended to the call. For example a reset can be triggered in the gdbinit file with "reset" or via GDB with "monitor reset".

The following remote commands are available:

Remote command	Explanation
clrbp	Removes an instruction breakpoint.
cp15	Reads or writes from/to cp15 register.
device	Select the specified target device.
DisableChecks	Do not check if an abort occurred after memory read (ARM7/9 only).
EnableChecks	Check if an abort occurred after memory read (ARM7/9 only).
flash breakpoints	Enables/Disables flash breakpoints.
flash erase	Erases the flash memory of the target device.
getargs	Get the arguments for the application.
go	Starts the target CPU.
halt	Halts the target CPU.
jtagconf	Configures a JTAG scan chain with multiple devices on it.
memU8	Reads or writes a byte from/to given address.
memU16	Reads or writes a halfword from/to given address.
memU32	Reads or writes a word from/to given address.
reg	Reads or writes from/to given register.
regs	Reads and displays all CPU registers.
reset	Resets and halts the target CPU.
semihosting breakOnError	Enable or disable halting the target on semihosting error.
semihosting enable	Enables semihosting.
semihosting IOClient	Set semihosting I/O to be handled via Telnet port or GDB.
semihosting ARMSWI	Sets the SWI number used for semihosting in ARM mode.
semihosting ThumbSWI	Sets the SWI number used for semihosting in thumb mode.
setargs	Set the arguments for the application.
setbp	Sets an instruction breakpoint at a given address.
sleep	Sleeps for a given time period.
speed	Sets the JTAG speed of J-Link / J-Trace.
step	Performs one or more single instruction steps.
SWO DisableTarget	Undo target configuration for SWO and disable it in J-Link.
SWO EnableTarget	Configure target for SWO and enable it in J-Link.
SWO GetMaxSpeed	Prints the maximum supported SWO speed for J-Link and Target CPU.
SWO GetSpeedInfo	Prints the available SWO speed and its minimum divider.
waithalt	Waits for target to halt code execution.

Remote command	Explanation
<code>wice</code>	Writes to given IceBreaker register.
<code>ReadAP</code>	Reads the specified CoreSight DAP-AP register.
<code>ReadDP</code>	Reads the specified CoreSight DAP-DP register.
<code>WriteAP</code>	Writes the specified CoreSight DAP-AP register.
<code>WriteDP</code>	Writes the specified CoreSight DAP-DP register.

The Following remote commands are deprecated and only available for backward compatibility:

Remote command	Explanation
<code>device</code>	Selects the specified target device. Note: Use command line option <code>-device</code> instead.
<code>interface</code>	Selects the target interface. Note: Use command line option <code>-if</code> instead.
<code>speed</code>	Sets the JTAG speed of J-Link / J-Trace. Note: For the initial connection speed, use command line option <code>-speed</code> instead.

Note

The remote commands are case-insensitive.

Note

Optional parameters are set into square brackets.

Note

The examples are described as follows:
 Lines starting with `'#'` are comments and not used in GDB / GDB Server.
 Lines starting with `'>'` are input commands from the GDB.
 Lines starting with `'<'` is the output from GDB Server as printed in GDB.

4.3.1 clrbp

Removes an instruction breakpoint, where `<BPHandle>` is the handle of breakpoint to be removed. If no handle is specified this command removes all pending breakpoints.

Syntax

```
ClrBP [<BPHandle>]
or
ci [<BPHandle>]
```

Example

```
> monitor clrbp 1
> monitor ci 1
```

4.3.2 cp15

Reads or writes from/to cp15 register. If <data> is specified, this command writes the data to the cp15 register. Otherwise this command reads from the cp15 register. For further information please refer to the ARM reference manual.

Syntax

```
cp15 <CRn>, <CRm>, <op1>, <op2> [= <data>]
```

The parameters of the function are equivalent to the MCR instructions described in the ARM documents.

Example

```
#Read:
> monitor cp15 1, 2, 6, 7
< Reading CP15 register (1,2,6,7 = 0x0460B77D)

#Write:
> monitor cp15 1, 2, 6, 7 = 0xFFFFFFFF
```

4.3.3 device

Note

Deprecated. Use command line option `-device` instead.

Selects the specified target device. This is necessary for the connection and some special handling of the device.

Note

The device should be selected via commandline option `-device` when starting GDB Server.

Syntax

```
device <DeviceName>
```

Example

```
> monitor device STM32F417IG
< Selecting device: STM32F417IG
```

4.3.4 DisableChecks

Disables checking if a memory read caused an abort (ARM7/9 devices only). On some CPUs during the init sequence for enabling access to the internal memory (for example on the TMS470) some dummy reads of memory are required which will cause an abort as long as the access-init is not completed.

Syntax

```
DisableChecks
```

4.3.5 EnableChecks

Enables checking if a memory read caused an abort (ARM7/9 devices only). On some CPUs during the init sequence for enabling access to the internal memory (for example on the TMS470) some dummy reads of memory are required which will cause an abort as long as the access-init is not completed. The default state is: Checks enabled.

Syntax

```
EnableChecks
```

4.3.6 flash breakpoints

This command enables/disables the Flash Breakpoints feature. By default Flash Breakpoints are enabled and can be used for evaluation.

Syntax

```
monitor flash breakpoints = <Value>
```

Example

```
#Disable Flash Breakpoints:  
> monitor flash breakpoints = 0  
< Flash breakpoints disabled  
  
#Enable Flash Breakpoints:  
> monitor flash breakpoints = 1  
< Flash breakpoints enabled
```

4.3.7 flash erase

This command erases the flash memory of the target device.

Syntax

```
flash erase
```

4.3.8 getargs

Get the currently set argument list which will be given to the application when calling semihosting command SYS_GET_CMDLINE (0x15). The argument list is given as one string.

Syntax

```
getargs
```

Example

```
#No arguments set via setargs:  
> monitor getargs  
< No arguments.  
#Arguments set via setargs:  
> monitor getargs  
< Arguments: test 0 1 2 arg0=4
```

4.3.9 go

Starts the target CPU.

Syntax

```
go
```

Example

```
> monitor go
```

4.3.10 halt

Halts the target CPU.

Syntax

```
halt
```

Example

```
> monitor halt
```

4.3.11 interface

Note

Deprecated. Use command line option `-if` instead.

Selects the target interface used by J-Link / J-Trace.

Syntax

```
interface <InterfaceIdentifier>
```

4.3.12 jtagconf

Configures a JTAG scan chain with multiple devices on it. <IRPre> is the sum of IRLens of all devices closer to TDI, where IRLen is the number of bits in the IR (Instruction Register) of one device. <DRPre> is the number of devices closer to TDI. For more detailed information of how to configure a scan chain with multiple devices please refer to *Determining values for scan chain configuration* .

Note

To make sure the connection to the device can be established correctly, it is recommended to configure the JTAG scan chain via command line options at the start of GDB Server.

Syntax

```
jtagconf <IRPre> <DRPre>
```

Example

```
#Select the second device, where there is 1 device in front with IRLen 4  
> monitor jtagconf 4 1
```

4.3.13 memU8

Reads or writes a byte from/to a given address. If <value> is specified, this command writes the value to the given address. Otherwise this command reads from the given address.

Syntax

```
memU8 <address> [= <value>]
```

Example

```
#Read:
> monitor memU8 0x50000000
< Reading from address 0x50000000 (Data = 0x04)

#Write:
> monitor memU8 0x50000000 = 0xFF
< Writing 0xFF @ address 0x50000000
```

4.3.14 memU16

Reads or writes a halfword from/to a given address. If <value> is specified, this command writes the value to the given address. Otherwise this command reads from the given address.

Syntax

```
memU16 <address> [= <value>]
```

Example

```
#Read:
> monitor memU16 0x50000000
< Reading from address 0x50000000 (Data = 0x3004)

#Write:
> monitor memU16 0x50000000 = 0xFF00
< Writing 0xFF00 @ address 0x50000000
```

4.3.15 memU32

Reads or writes a word from/to a given address. If <value> is specified, this command writes the value to the given address. Otherwise this command reads from the given address. This command is similar to the long command.

Syntax

```
memU32 <address> [= <value>]
```

Example

```
#Read:
> monitor memU32 0x50000000
< Reading from address 0x50000000 (Data = 0x10023004)

#Write:
> monitor memU32 0x50000000 = 0x10023004
< Writing 0x10023004 @ address 0x50000000
```

4.3.16 reg

Reads or writes from/to given register. If <value> is specified, this command writes the value into the given register. If <address> is specified, this command writes the memory content at address <address> to register <RegName>. Otherwise this command reads the given register.

Syntax

```
reg <RegName> [= <value>]
or
reg <RegName> [= (<address>)]
```

Example

```
#Write value to register:
> monitor reg pc = 0x00100230
< Writing register (PC = 0x00100230)

#Write value from address to register:
> monitor reg r0 = (0x00000040)
< Writing register (R0 = 0x14813004)

#Read register value:
> monitor reg PC
< Reading register (PC = 0x00100230)
```

4.3.17 regs

Reads all CPU registers.

Syntax

```
regs
```

Example

```
> monitor regs
< PC = 00100230, CPSR = 20000013 (SVC mode, ARM)
R0 = 14813004, R1 = 00000001, R2 = 00000001, R3 = 000003B5
R4 = 00000000, R5 = 00000000, R6 = 00000000, R7 = 00000000
USR: R8 =00000000, R9 =00000000, R10=00000000, R11 =00000000, R12 =00000000
R13=00000000, R14=00000000
FIQ: R8 =00000000, R9 =00000000, R10=00000000, R11 =00000000, R12 =00000000
R13=00200000, R14=00000000, SPSR=00000010
SVC: R13=002004E8, R14=0010025C, SPSR=00000010
ABT: R13=00200100, R14=00000000, SPSR=00000010
IRQ: R13=00200100, R14=00000000, SPSR=00000010
UND: R13=00200100, R14=00000000, SPSR=00000010
```

4.3.18 reset

Resets and halts the target CPU. Make sure the device is selected prior to using this command to make use of the correct reset strategy.

Note

There are different reset strategies for different CPUs. Moreover, the reset strategies which are available differ from CPU core to CPU core. J-Link can perform various reset strategies and always selects the best fitting strategy for the selected device.

Syntax

```
reset
```

Example

```
> monitor reset
< Resetting target
```

4.3.19 semihosting breakOnError

Enables or disables halting the target at the semihosting breakpoint / in SVC handler if an error occurred during a semihosting command, for example a bad file handle for SYS_WRITE. The GDB Server log window always shows a warning in these cases. breakOnError is disabled by default.

Syntax

```
semihosting breakOnerror <Value>
```

Example

```
#Enable breakOnError:
> monitor semihosting breakOnError 1
```

4.3.20 semihosting enable

Enables semihosting with the specified vector address. If no vector address is specified, the SWI vector (at address 0x8) will be used. GDBServer will output semihosting terminal data from the target via a separate connection on port 2333. Some IDEs already establish a connection automatically on this port and show terminal data in a specific window in the IDE. For IDEs which do not support semihosting terminal output directly, the easiest way to view semihosting output is to open a telnet connection to the GDBServer on port 2333. The connection on this port can be opened all the time as soon as GDBServer is started, even before this remote command is executed.

Syntax

```
semihosting enable [<VectorAddr>]
```

Example

```
> monitor semihosting enable
< Semihosting enabled (VectorAddr = 0x08)
```

4.3.21 semihosting IOClient

GDB itself can handle (file) I/O operations, too. With this command it is selected whether to print output via TELNET port (2333), GDB, or both.

<ClientMask> is

- 1 for TELNET Client (Standard port 2333) (Default)
- 2 for GDB Client
- or 3 for both (Input via GDB Client)

Syntax

```
semihosting IOClient <ClientMask>
```

Example

```
#Select TELNET port as output source
> monitor semihosting ioclient 1
< Semihosting I/O set to TELNET Client

#Select GDB as output source
> monitor semihosting ioclient 2
< Semihosting I/O set to GDB Client

#Select TELNET port and GDB as output source
> monitor semihosting ioclient 3
< Semihosting I/O set to TELNET and GDB Client
```

4.3.22 semihosting ARMSWI

Sets the SWI number used for semihosting in ARM mode. The default value for the ARMSWI is 0x123456.

Syntax

```
semihosting ARMSWI <Value>
```

Example

```
> monitor semihosting ARMSWI 0x123456
< Semihosting ARM SWI number set to 0x123456
```

4.3.23 semihosting ThumbSWI

Sets the SWI number used for semihosting in thumb mode. The default value for the ThumbSWI is 0xAB

Syntax

```
semihosting ThumbSWI <Value>
```

Example

```
> monitor semihosting ThumbSWI 0xAB
< Semihosting Thumb SWI number set to 0xAB
```

4.3.24 setargs

Set arguments for the application, where all arguments are in one <ArgumentString> separated by whitespaces. The argument string can be gotten by the application via semihosting command SYS_GET_CMDLINE (0x15). Semihosting has to be enabled for getting the argumentstring (see *semihosting enable*). "monitor setargs" can be used before enabling semihosting. The maximum length for <ArgumentString> is 512 characters.

Syntax

```
setargs <ArgumentString>
```

Example

```
> monitor setargs test 0 1 2 arg0=4
< Arguments: test 0 1 2 arg0=4
```

4.3.25 setbp

Sets an instruction breakpoint at the given address, where <Mask> can be 0x03 for ARM instruction breakpoints (Instruction width 4 Byte, mask out lower 2 bits) or 0x01 for THUMB instruction breakpoints (Instruction width 2 Byte, mask out lower bit). If no mask is given, an ARM instruction breakpoint will be set.

Syntax

```
setbp <Addr> [<Mask>]
```

Example

```
#Set a breakpoint (implicit for ARM instructions)
> monitor setbp 0x00000000

#Set a breakpoint on a THUMB instruction
> monitor setbp 0x00000100 0x01
```

4.3.26 sleep

Sleeps for a given time, where <Delay> is the time period in milliseconds to delay. While sleeping any communication is blocked until the command returns after the given period.

Syntax

```
sleep <Delay>
```

Example

```
> monitor sleep 1000
< Sleep 1000ms
```

4.3.27 speed

Note

Deprecated. For setting the initial connection speed, use command line option [-speed](#) instead.

Sets the JTAG speed of J-Link / J-Trace. Speed can be either fixed (in kHz), automatic recognition or adaptive. In general, Adaptive is recommended if the target has an RTCK signal which is connected to the corresponding RTCK pin of the device (S-cores only). For detailed information about the different modes, refer to *JTAG Speed*. The speed has to be set after selecting the interface, to change it from its default value.

Syntax

```
speed <kHz>|auto|adaptive
```

Example

```
> monitor speed auto
< Select auto target interface speed (8000 kHz)

> monitor speed 4000
< Target interface speed set to 4000 kHz

> monitor speed adaptive
< Select adaptive clocking instead of fixed JTAG speed
```

4.3.28 step

Performs one or more single instruction steps, where <NumSteps> is the number of instruction steps to perform. If <NumSteps> is not specified only one instruction step will be performed.

Syntax

```
step [<NumSteps>]
or
si [<NumSteps>]
```

Example

```
> monitor step 3
```

4.3.29 SWO DisableTarget

Disables the output of SWO data on the target (Undoes changes from SWO EnableTarget) and stops J-Link to capture it.

Syntax

```
SWO DisableTarget <PortMask[0x01-0xFFFFFFFF]>
```

Example

```
#Disable capturing SWO from stimulus ports 0 and 1
> monitor SWO DisableTarget 3
< SWO disabled successfully.
```

4.3.30 SWO EnableTarget

Configures the target to be able to output SWO data and starts J-Link to capture it. CPU and SWO frequency can be 0 for auto-detection.

If CPUFreq is 0, J-Link will measure the current CPU speed.

If SWOFreq is 0, J-Link will use the highest available SWO speed for the selected / measured CPU speed.

Note

CPUFreq has to be the speed at which the target will be running when doing SWO. If the speed is different from the current speed when issuing CPU speed auto-detection, getting SWO data might fail. SWOFreq has to be a quotient of the CPU and SWO speeds and their prescalers. To get available speed, use SWO GetSpeedInfo. PortMask can be a decimal or hexadecimal Value. Values starting with the Prefix "0x" are handled hexadecimal.

Syntax

```
SWO EnableTarget <CPUFreq[Hz]> <SWOFreq[Hz]> <PortMask[0x01-0xFFFFFFFF]
<Mode[0]>
```

Example

```
#Configure SWO for stimulus port 0, measure CPU frequency and calculate SWO
frequency
> monitor SWO EnableTarget 0 0 1 0
```



```

< SWO enabled successfully.

#Configure SWO for stimulus ports 0-2, fixed SWO frequency and measure CPU
frequency
> monitor SWO EnableTarget 0 1200000 5 0
< SWO enabled successfully.

#Configure SWO for stimulus ports 0-255, fixed CPU and SWO frequency
> monitor SWO EnableTarget 72000000 6000000 0xFF 0
< SWO enabled successfully.

```

4.3.31 SWO GetMaxSpeed

Prints the maximum SWO speed supported by and matching both, J-Link and the target CPU frequency.

Syntax

```
SWO GetMaxSpeed <CPUFrequency [Hz]>
```

Example

```

#Get SWO speed for 72MHz CPU speed
> monitor SWO GetMaxSpeed 72000000
< Maximum supported SWO speed is 6000000 Hz.

```

4.3.32 SWO GetSpeedInfo

Prints the base frequency and the minimum divider of the connected J-Link. With this information, the available SWO speeds for J-Link can be calculated and the matching one for the target CPU frequency can be selected.

Syntax

```
SWO GetSpeedInfo
```

Example

```

> monitor SWO GetSpeedInfo
< Base frequency: 60000000Hz, MinDiv: 8
# Available SWO speeds for J-Link are: 7.5MHz, 6.66MHz, 6MHz, ...

```

4.3.33 waithalt

Waits for target to halt code execution, where <Timeout> is the maximum time period in milliseconds to wait.

Syntax

```
waithalt <Timeout>
or
wh <Timeout>
```

Example

```

#Wait for halt with a timeout of 2 seconds
> monitor waithalt 2000

```

4.3.34 wice

Writes to given IceBreaker register, where <value> is the data to write.

Syntax

```
wice <RegIndex> <value>
or
rmib <RegIndex> <value>
```

Example

```
> monitor wice 0x0C 0x100
```

4.3.35 ReadAP

Reads the specified CoreSight DAP-AP register.

Note

- ARM specifies register addresses for JTAG (0x0, 0x4, 0x8, ...) and register indexes for SWD (0, 1, 2, ...).

This API always works with register indexes, so:

- Addr 0x0 = RegIndex 0
- Addr 0x4 = RegIndex 1
- Addr 0x8 = RegIndex 2
- Addr 0xC = RegIndex 3
- In case a WAIT response is received from the DAP, J-Link will retry the access until OK/FAULT is received or the operation times out (100ms).
- Performs a fully qualified read. This means that for AP accesses which are "registered", J-Link performs an implicit read of AP-RDBUFF after the AP access, to get the actual value.

Syntax

```
ReadAP [<RegIndex>]
```

Example

```
> # Select AP[0] (AHB-AP) AP bank 0
> monitor WriteDP 2 0x00000000
< O.K.
> # Read AHB-AP TAR
> monitor ReadAP 1
< O.K.:0x08000000
```

4.3.36 ReadDP

Reads the specified CoreSight DAP-DP register.

Note

- ARM specifies register addresses for JTAG (0x0, 0x4, 0x8, ...) and register indexes for SWD (0, 1, 2, ...).

This API always works with register indexes, so:

- Addr 0x0 = RegIndex 0
- Addr 0x4 = RegIndex 1

- Addr 0x8 = RegIndex 2
- Addr 0xC = RegIndex 3
- In case a WAIT response is received from the DAP, J-Link will retry the access until OK/FAULT is received or the operation times out (100ms).
- Performs a fully qualified read. This means that for AP accesses which are "registered", J-Link performs an implicit read of DP-RDBUFF after the DP access, to get the actual value.

Syntax

ReadDP [<RegIndex>]

Example

```
> # Read CTRL/STAT
> monitor ReadDP 1
< O.K.:0xF0000000
```

4.3.37 WriteAP

Writes the specified CoreSight DAP-AP register.

Note

- ARM specifies register addresses for JTAG (0x0, 0x4, 0x8, ...) and register indexes for SWD (0, 1, 2, ...).

This API always works with register indexes, so:

- Addr 0x0 = RegIndex 0
- Addr 0x4 = RegIndex 1
- Addr 0x8 = RegIndex 2
- Addr 0xC = RegIndex 3
- In case a WAIT response is received from the DAP, J-Link will retry the access until OK/FAULT is received or the operation times out (100ms).

Syntax

WriteAP [<RegIndex>, <Data>]

Example

```
> # Select AP[0] (AHB-AP) AP bank 0
> monitor WriteDP 2 0x00000000
< O.K.
> # Write AHB-AP TAR
> monitor WriteAP 1 0x08000000
< O.K.
```

4.3.38 WriteDP

Writes the specified CoreSight DAP-DP register.

Note

- ARM specifies register addresses for JTAG (0x0, 0x4, 0x8, ...) and register indexes for SWD (0, 1, 2, ...).

This API always works with register indexes, so:

- Addr 0x0 = RegIndex 0

- Addr 0x4 = RegIndex 1
- Addr 0x8 = RegIndex 2
- Addr 0xC = RegIndex 3
- In case a WAIT response is received from the DAP, J-Link will retry the access until OK/FAULT is received or the operation times out (100ms).

Syntax

```
WriteDP [<RegIndex>, <Data>]
```

Example

```
> # Write SELECT register: Select AP[0] (AHB-AP) AP bank 15  
> monitor WriteDP 2 0x000000F0  
< O.K.
```

4.4 SEGGER-specific GDB protocol extensions

J-Link GDB Server implements some functionality which are not part of the standard GDB remote protocol in general query packets. These SEGGER-specific general query packets can be sent to GDB Server on the low-level of GDB, via maintenance commands, or with a custom client connected to GDB Server.

As these extensions are not of interest for the regular user, they have been added to a separate manual that describes the SEGGER-specific GDB protocol extensions that have been added to J-Link GDB Server. The manual is available for download on the SEGGER website: [UM08036](#)

4.5 Command line options

There are several command line options available for the GDB Server which allow configuration of the GDB Server before any connection to a J-Link is attempted or any connection from a GDB client is accepted.

Note

Using GDB Server CL, device, interface, endian and speed are mandatory options to correctly connect to the target, and should be given before connection via GDB. Using GDB Server GUI the mandatory options can also be selected in the configuration dialog.

Command line option	Explanation
<code>-device</code>	Selects the connected target device.
<code>-endian</code>	Selects the device endianness.
<code>-if</code>	Selects the interface to connect to the target.
<code>-speed</code>	Selects the target communication speed.

Note

Using multiple instances of GDB Server, setting custom values for port, SWOPort and TelnetPort is necessary.

Command line option	Explanation
<code>-port</code>	Select the port to listen for GDB clients.
<code>-swoport</code>	Select the port to listen for clients for SWO RAW output.
<code>-telnetport</code>	Select the port to listen for clients for printf output.

The GDB Server GUI version uses persistent settings which are saved across different instances and sessions of GDB Server. These settings can be toggled via the checkboxes in the GUI.

Note

GDB Server CL always starts with the settings marked as default.

For GUI and CL, the settings can be changed with following command line options. For all persistent settings there is a pair of options to enable or disable the feature.

Command line option	Explanation
<code>-ir</code>	Initialize the CPU registers on start of GDB Server. (Default)
<code>-noir</code>	Do not initialize CPU registers on start of GDB Server.
<code>-localhostonly</code>	Allow only localhost connections (Windows default)
<code>-nolocalhostonly</code>	Allow connections from outside localhost (Linux default)
<code>-logtofile</code>	Generate a GDB Server log file.
<code>-nologtofile</code>	Do not generate a GDB Server log file. (Default)
<code>-halt</code>	Halt the target on start of GDB Server. (Default)
<code>-nohalt</code>	Do not halt the target on start of GDB Server.
<code>-silent</code>	Do not show log output.
<code>-nosilent</code>	Show log output. (Default)

Command line option	Explanation
<code>-stayontop</code>	Set the GDB Server GUI to be the topmost window.
<code>-nostayontop</code>	Do not be the topmost window. (Default)
<code>-timeout</code>	Set the time after which the target has to be connected.
<code>-notimeout</code>	Set infinite timeout for target connection.
<code>-vd</code>	Verify after downloading.
<code>-novd</code>	Do not verify after downloading. (Default)

Following additional command line options are available. These options are temporary for each start of GDB Server.

Command line option	Explanation
<code>-excdbg</code>	Enable exception debugging.
<code>-jtagconf</code>	Configures a JTAG scan chain with multiple devices on it.
<code>-log</code>	Logs the GDB Server communication to a specific file.
<code>-rtos</code>	Selects a RTOS plugin (DLL file)
<code>-singlerun</code>	Starts GDB Server in single run mode.
<code>-s</code>	Same as <code>-singlerun</code>
<code>-nosinglerun</code>	Starts GDB Server in no single run mode. (Default)
<code>-nos</code>	Same as <code>-nosinglerun</code>
<code>-noreset</code>	Starts GDB Server in no reset mode.
<code>-JLinkDevicesXMLPath</code>	Passes JLinkDevices.xml file to the DLL
<code>-powertarget</code>	Power target after specified delay (1-9). 0 turns off power.
<code>-gui</code>	Do not suppress DLL dialogs. (Default)
<code>-nogui</code>	Suppress DLL Dialogs.
<code>-jlinkscriptfile</code>	Specifies a J-Link script file.
<code>-select</code>	Selects the interface to connect to J-Link (USB/IP).
<code>-settingsfile</code>	Selects the J-Link Settings File.
<code>-strict</code>	Starts GDB Server in strict mode.
<code>-x</code>	Executes a gdb file on first connection.
<code>-xc</code>	Executes a gdb file on every connection.
<code>-cpu</code>	Selects the CPU core. Deprecated, use <code>-device</code> instead.

4.5.1 -cpu

Pre-select the CPU core of the connected device, so the GDB Server already knows the register set, even before having established a connection to the CPU.

Note

Deprecated, please use `-device` instead. Anyhow, it does not hurt if this option is set, too.

Syntax

```
-CPU <CPUCore>
```

Example

```
jlinkgdbserver -CPU ARM7_9
```

Add. information

The following table lists all valid values for <CPUCore> :

<CPUCore>	Supported CPU cores
CPU_FAMILY_ARM7_9	Pre-select ARM7 and ARM9 as CPU cores.
CPU_FAMILY_CORTEX_A_R	Pre-select Cortex-A and Cortex-R as CPU cores.
CPU_FAMILY_CORTEX_M	Pre-select Cortex-M as CPU core.
CPU_FAMILY_RX600	Pre-select Renesas RX600 as CPU core.

4.5.2 -device

Tells GDBServer to which device J-Link is connected before the connect sequence is actually performed. It is recommended to use the command line option to select the device instead of using the remote command since for some devices J-Link already needs to know the device at the time of connecting to it since some devices need special connect sequences (e.g. devices with TI ICEPick modules). In such cases, it is not possible to select the device via remote commands since they are configured after the GDB client already connected to GDBServer and requested the target registers which already requires a connection to the target.

Note

Using GDB Server CL this option is mandatory to correctly connect to the target, and should be given before connection via GDB.

Syntax

```
-device <DeviceName>
```

Example

```
jlinkgdbserver -device AT91SAM7SE256
```

Add. information

For a list of all valid values for <DeviceName> , please refer to [List of supported target devices](#) .

4.5.3 -endian

Sets the endianness of the target where endianness can either be "little" or "big".

Syntax

```
-endian <endianness>
```

Example

```
jlinkgdbserver -endian little
```

Note

When using GDB Server CL this option is mandatory to correctly connect to the target, and should be given before connection via GDB.

4.5.4 -gui

Do not suppress DLL dialogs.

Syntax

```
-gui
```

Example

```
jlinkgdbserver -gui
```

4.5.5 -if

Selects the target interface which is used by J-Link to connect to the device. The default value is JTAG.

Syntax

```
-if <Interface>
```

Example

```
jlinkgdbserver -if SWD
```

Add. information

Currently, the following values are accepted for <Interface> :

- JTAG
- SWD
- FINE
- 2-wire-JTAG-PIC32

4.5.6 -ir

Initializes the CPU register with default values on startup.

Note

For the GUI version, this setting is persistent for following uses of GDB Server until changed via -noir or the GUI.

Example

```
jlinkgdbserver -ir
```

4.5.7 -excdbg

Enables exception debugging. Exceptions on ARM CPUs are handled by exception handlers. Exception debugging makes the debugging of exceptions more user-friendly by passing a signal to the GDB client and returning to the causative instruction. In order to do this, a special exception handler is required as follows:

```
__attribute__((naked)) void OnHardFault(void){
  __asm volatile (
    " bkpt 10 \n"
    " bx lr \n"
  );
}
```

The signal passed to the GDB client is the immediate value (10 in the example) of the software breakpoint instruction. <nSteps> specifies, how many instructions need to be

executed until the exception return occurs. In most cases this will be 2 (which is the default value), if the handler function is set as the exception handler. If it is called indirectly as a subroutine from the exception handler, there may be more steps required. It is mandatory to have the function declared with the "naked" attribute and to have the `bx lr` instruction immediately after the software breakpoint instruction. Otherwise the software breakpoint will be treated as a usual breakpoint.

Syntax

```
-excdbg <nSteps>
```

Example

```
jlinkgdbserver -excdbg 4
```

4.5.8 -jtagconf

Configures a JTAG scan chain with multiple devices on it. `<IRPre>` is the sum of `IRLen`s of all devices closer to TDI, where `IRLen` is the number of bits in the IR (Instruction Register) of one device. `<DRPre>` is the number of devices closer to TDI. For more detailed information of how to configure a scan chain with multiple devices please refer to *Determining values for scan chain configuration*.

Syntax

```
-jtagconf <IRPre>,<DRPre>
```

Example

```
#Select the second device, where there is 1 device in front with IRLen 4
jlinkgdbserver -jtagconf 4,1
```

4.5.9 -localhostonly

Starts the GDB Server with the option to listen on localhost only (This means that only TCP/IP connections from localhost are accepted) or on any IP address. To allow remote debugging (connecting to GDBServer from another PC), deactivate this option. If no parameter is given, it will be set to 1 (active).

Note

For the GUI version, this setting is persistent for following uses of GDB Server until changed via command line option or the GUI.

Syntax

```
-LocalhostOnly <State>
```

Example

```
jlinkgdbserver -LocalhostOnly 0 //Listen on any IP address (Linux/MAC default)
jlinkgdbserver -LocalhostOnly 1 //Listen on localhost only (Windows default)
```

4.5.10 -log

Starts the GDB Server with the option to write the output into a given log file. The file will be created if it does not exist. If it exists the previous content will be removed. Paths including spaces need to be set between quotes.

Syntax

```
-log <LogFilePath>
```

Example

```
jlinkgdbserver -log "C:\my path\to\file.log"
```

4.5.11 -logtofile

Starts the GDB Server with the option to write the output into a log file. If no file is given via `-log`, the log file will be created in the GDB Server application directory.

Note

For the GUI version, this setting is persistent for following uses of GDB Server until changed via `-nologtofile` or the GUI.

Syntax

```
logtofile
```

Example

```
jlinkgdbserver -logtofile  
jlinkgdbserver -logtofile -log "C:\my path\to\file.log"
```

4.5.12 -halt

Halts the target after connecting to it on start of GDB Server. For most IDEs this option is mandatory since they rely on the target to be halted after connecting to GDB Server.

Note

For the GUI version, this setting is persistent for following uses of GDB Server until changed via `-nohalt` or the GUI.

Syntax

```
-halt
```

Example

```
jlinkgdbserver -halt
```

4.5.13 -nogui

Suppresses DLL dialogs.

Syntax

```
-nogui
```

Example

```
jlinkgdbserver -nogui
```

4.5.14 -noir

Do not initialize the CPU registers on startup.

Note

For the GUI version, this setting is persistent for following uses of GDB Server until changed via `-ir` or the GUI.

Syntax

`noir`

4.5.15 `-nolocalhostonly`

Starts GDB Server with the option to allow remote connections (from outside localhost). Same as `-localhostonly 0`

Note

For the GUI version, this setting is persistent for following uses of GDB Server until changed via command line option or the GUI.

Syntax

`-nolocalhostonly`

4.5.16 `-nologtofile`

Starts the GDB Server with the option to not write the output into a log file.

Note

For the GUI version, this setting is persistent for following uses of GDB Server until changed via `-nologtofile` or the GUI. When this option is used after `-log`, no log file will be generated, when `-log` is used after this option, a log file will be generated and this setting will be overridden.

Syntax

`-nologtofile`

Example

```
jlinkgdbserver -nologtofile // Will not generate a log file
jlinkgdbserver -nologtofile -log "C:\pathto\file.log" // Will generate a log
file
jlinkgdbserver -log "C:\pathto\file.log" -nologtofile // Will not generate
a log file
```

4.5.17 `-nohalt`

When connecting to the target after starting GDB Server, the target is not explicitly halted and the CPU registers will not be initied. After closing all GDB connections the target is started again and continues running. Some IDEs rely on the target to be halted after connect. In this case do not use `-nohalt`, but `-halt`.

Note

For the GUI version, this setting is persistent for following uses of GDB Server until changed via `-halt` or the GUI.

Syntax

```
-nohalt
```

Example

```
jlinkgdbserver -nohalt
```

4.5.18 -noreset

Perform no reset on connect, just halt the CPU

Syntax

```
-noreset
```

Example

```
jlinkgdbserver -noreset
```

4.5.19 -nosinglerun

Single run mode turned off. (Default)

Syntax

```
-nosinglerun
```

Example

```
jlinkgdbserver -nosinglerun
```

4.5.20 -nosilent

Starts the GDB Server in non-silent mode. All log window messages will be shown.

Note

For the GUI version, this setting is persistent for following uses of GDB Server until changed via command line option or the GUI.

Syntax

```
-nosilent
```

4.5.21 -nostayontop

Starts the GDB Server in non-topmost mode. All windows can be placed above it.

Note

For the CL version this setting has no effect. For the GUI version, this setting is persistent for following uses of GDB Server until changed via command line option or the GUI.

Syntax

```
-nostayontop
```

Example

4.5.22 -notimeout

GDB Server automatically closes after a timeout of 5 seconds when no target voltage can be measured or connection to target fails. This command line option prevents GDB Server from closing, to allow connecting a target after starting GDB Server.

Note

The recommended order is to power the target, connect it to J-Link and then start GDB Server.

Syntax

```
-notimeout
```

4.5.23 -novd

Do not explicitly verify downloaded data.

Note

For the GUI version, this setting is persistent for following uses of GDB Server until changed via command line option or the GUI.

Syntax

```
-vd
```

4.5.24 -port

Starts GDB Server listening on a specified port. This option overrides the default listening port of the GDB Server. The default port is 2331.

Note

Using multiple instances of GDB Server, setting custom values for this option is necessary.

Syntax

```
-port <Port>
```

Example

```
jlinkgdbserver -port 2345
```

4.5.25 -rtos

Specifies a RTOS plug-in (.DLL file for Windows, .SO file for Linux and Mac). If the file-name extension is not specified, it is automatically added depending on the PC's operating system. The J-Link Software and Documentation Package comes with RTOS plug-ins for embOS and FreeRTOS pre-installed in the sub-directory "GDBServer". A software development kit (SDK) for creating your own plug-ins is also available upon request.

Syntax

```
-rtos <filename>[.dll|.so]
```

Example

```
jlinkgdbserver -rtos GDBServer\RTOSPlugin_embOS
```

4.5.26 -JLinkDevicesXMLPath

Passes JLinkDevices.xml file to the DLL.

Syntax

```
-JLinkDevicesXMLPath <filename>[.xml]
```

Example

```
jlinkgdbserver -JLinkDevicesXMLPath.xml
```

4.5.27 -jlinkscriptfile

Passes the path of a J-Link script file to the GDB Server. This scriptfile is executed before the GDB Server starts the debugging / identifying communication with the target. J-Link scriptfiles are mainly used to connect to targets which need a special connection sequence before communication with the core is possible. For more information about J-Link script files, please refer to *J-Link script files* .

Syntax

```
-jlinkscriptfile <ScriptFilePath>
```

Example

```
-jlinkscriptfile "C:\My Projects\Default.JLinkScript"
```

4.5.28 -powertarget

Power target after specified delay (1-9 ms). 0 turns off power.

Syntax

```
-powertarget <Value>
```

Value can range from 0-9.

Example

```
jlinkgdbserver -powertarget 1
```

4.5.29 -select

Specifies the host interface to be used to connect to J-Link. Currently, USB and TCP/IP are available.

Syntax

```
-select <Interface#<SerialNo>/<IPAddr>
```

Example

```
jlinkgdbserver -select usb=580011111  
jlinkgdbserver -select ip=192.168.1.10
```

Additional information

For backward compatibility, when USB is used as interface serial numbers from 0-3 are accepted as USB=0-3 to support the old method of connecting multiple J-Links to a PC.

This method is no longer recommended to be used. Please use the “connect via emulator serial number” method instead.

4.5.30 -settingsfile

Select a J-Link settings file to be used for the target device. The settings file can contain all configurable options of the Settings tab in J-Link Control panel.

Syntax

```
-SettingsFile <PathToFile>
```

Example

```
jlinkgdbserver -SettingsFile "C:\Temp\GDB Server.jlink"
```

4.5.31 -silent

Starts the GDB Server in silent mode. No log window messages will be shown.

Note

For the GUI version, this setting is persistent for following uses of GDB Server until changed via command line option or the GUI.

Syntax

```
-silent
```

4.5.32 -singlerun

Starts GDB Server in single run mode. When active, GDB Server will close when all client connections are closed. In normal run mode GDB Server will stay open and wait for new connections. When started in single run mode GDB Server will close immediately when connecting to the target fails. Make sure it is powered and connected to J-Link before starting GDB Server.

Syntax

```
-s  
-singlerun
```

4.5.33 -speed

Starts GDB Server with a given initial speed. Available parameters are “adaptive”, “auto” or a freely selectable integer value in kHz. It is recommended to use either a fixed speed or, if it is available on the target, adaptive speeds.

Note

Using GDB Server CL this option is mandatory to correctly connect to the target, and should be given before connection via GDB.

Syntax

```
-speed <Speed_kHz>
```

Example

```
jlinkgdbserver -speed 2000
```

4.5.34 -stayontop

Starts the GDB Server in topmost mode. It will be placed above all non-topmost windows and maintains its position even when it is deactivated.

Note

For the CL version this setting has no effect. For the GUI version, this setting is persistent for following uses of GDB Server until changed via command line option or the GUI.

Syntax

```
-stayontop
```

4.5.35 -timeout

Set the timeout after which the target connection has to be established. If no connection could be established GDB Server will close. The default timeout is 5 seconds for the GUI version and 0 for the command line version.

Note

The recommended order is to power the target, connect it to J-Link and then start GDB Server.

Syntax

```
-timeout <Timeout[ms]>
```

Example

Allow target connection within 10 seconds.

```
jlinkgdbserver -timeout 10000
```

4.5.36 -strict

Starts GDB Server in strict mode. When strict mode is active GDB Server checks the correctness of settings and exits in case of a failure. Currently the device name is checked. If no device name is given or the device is unknown to the J-Link, GDB Server exits instead of selecting "Unspecified" as device or showing the device selection dialog.

Syntax

```
-strict
```

Example

Following executions of GDB Server (CL) will cause exit of GDB Server. `jlinkgdbserver -strict -device UnknownDeviceName`

```
jlinkgdbservercl -strict
```

Following execution of GDB Server will show the device selection dialog under Windows or select "Unspecified" directly under Linux / OS X.

```
jlinkgdbserver -device UnknownDeviceName
```

4.5.37 -swoport

Set up port on which GDB Server should listen for an incoming connection that reads the SWO data from GDB Server. Default port is 2332.

Note

Using multiple instances of GDB Server, setting custom values for this option is necessary.

Syntax

```
-SWOPort <Port>
```

Example

```
jlinkgdbserver -SWOPort 2553
```

4.5.38 -telnetport

Set up port on which GDB Server should listen for an incoming connection that gets target's printf data (Semihosting and analyzed SWO data). Default port is 2333.

Note

Using multiple instances of GDB Server, setting custom values for this option is necessary.

Syntax

```
-TelnetPort <Port>
```

Example

```
jlinkgdbserver -TelnetPort 2554
```

4.5.39 -vd

Verifies the data after downloading it.

Note

For the GUI version, this setting is persistent for following uses of GDB Server until changed via command line option or the GUI.

Syntax

```
-vd
```

4.5.40 -x

Starts the GDB Server with a gdbinit (configuration) file. In contrast to the -xc command line option the GDB Server runs the commands in the gdbinit file once only direct after the first connection of a client.

Syntax

```
-x <ConfigurationFilePath>
```

Example

```
jlinkgdbserver -x C:\MyProject\Sample.gdb
```

4.5.41 -xc

Starts the GDB Server with a gdbinit (configuration) file. GDB Server executes the commands specified in the gdbinit file with every connection of a client / start of a debugging session.

Syntax

```
-xc <ConfigurationFilePath>
```

Example

```
jlinkgdbserver -xc C:\MyProject\Sample.gdb
```

4.6 Program termination

J-Link GDB Server is normally terminated by a close or Ctrl-C event. When the single run mode is active it will also close when an error occurred during start or after all connections to GDB Server are closed.

On termination GDB Server will close all connections and disconnect from the target device, letting it run.

4.6.1 Exit codes

J-Link GDB Server terminates with an exit code indicating an error by a non-zero exit code. The following table describes the defined exit codes of GDB Server.

Exit code	Description
0	No error. GDB Server closed normally.
-1	Unknown error. Should not happen.
-2	Failed to open listener port (Default: 2331)
-3	Could not connect to target. No target voltage detected or connection failed.
-4	Failed to accept a connection from GDB.
-5	Failed to parse the command line options, wrong or missing command line parameter.
-6	Unknown or no device name set.
-7	Failed to connect to J-Link.

4.7 Semihosting

Semihosting can be used with J-Link GDBServer and GDB based debug environments but needs to be explicitly enabled. For more information, please refer to *Enabling semihosting in J-Link GDBServer* .

Chapter 5

J-Mem

J-Mem is a GUI application to display and modify the RAM and SFRs (Special Function Registers) of target systems while the target is running.

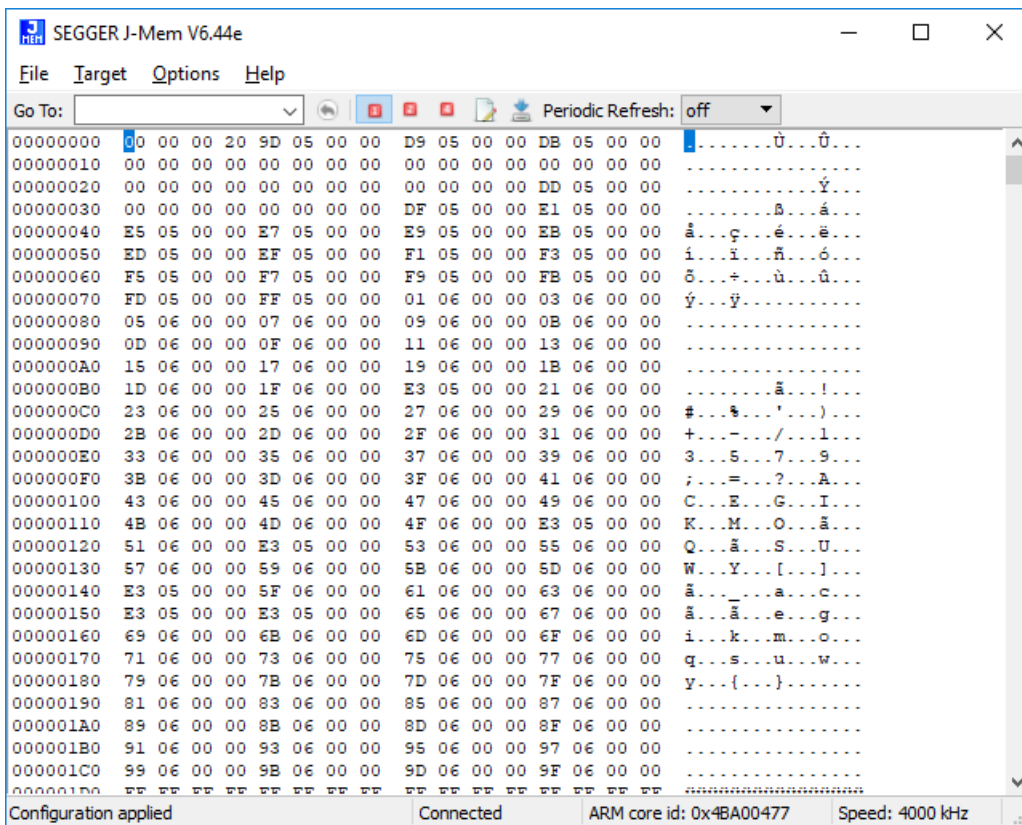

5.1 Setting up J-Mem

J-Mem is part of the J-Link Software Package and is available for Windows, Linux and macOS.

When starting J-Mem a configuration dialog pops up, letting you select the needed configurations to connect to J-Link and the target.

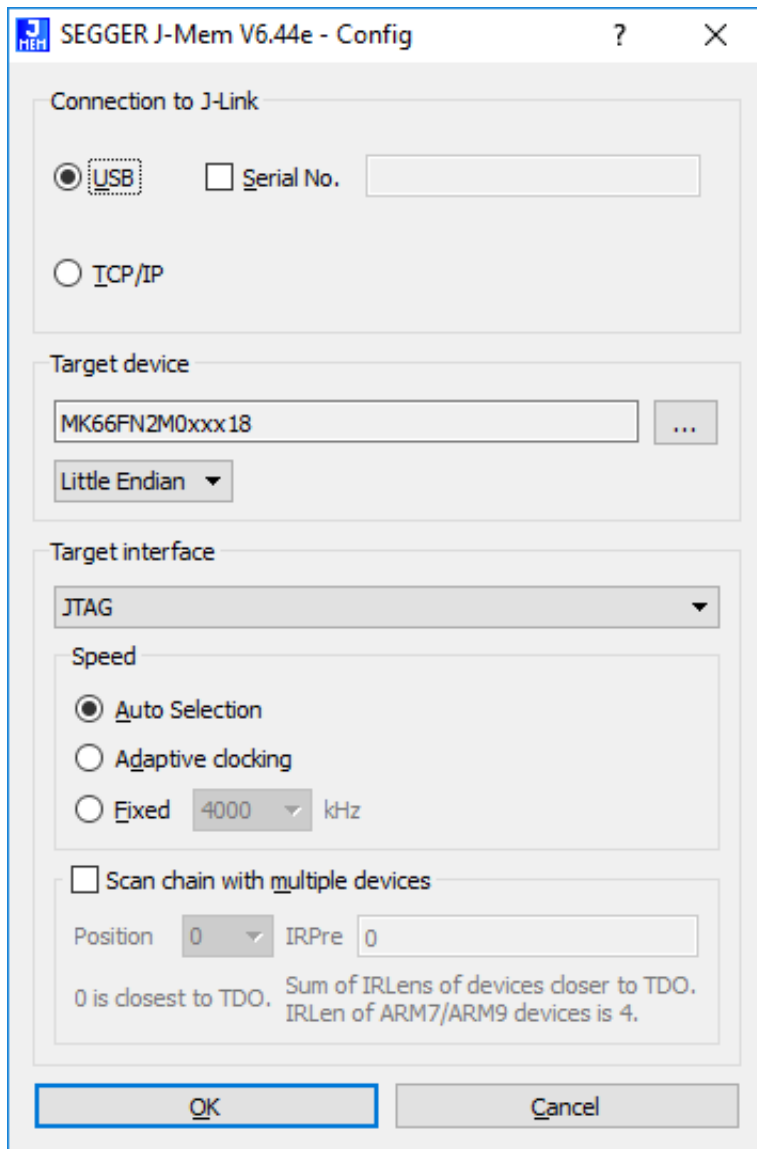

J-Mem: Configuration

Note

To make sure the connection to the target device can be established correctly, the device, as well as the interface and interface speed have to be given on start of J-Mem.

5.2 J-Mem user interface

The user interface of J-Mem shows the content of a memory region from the target that J-Link is connected to. Furthermore, details about the connection to the target are displayed in the status bar.

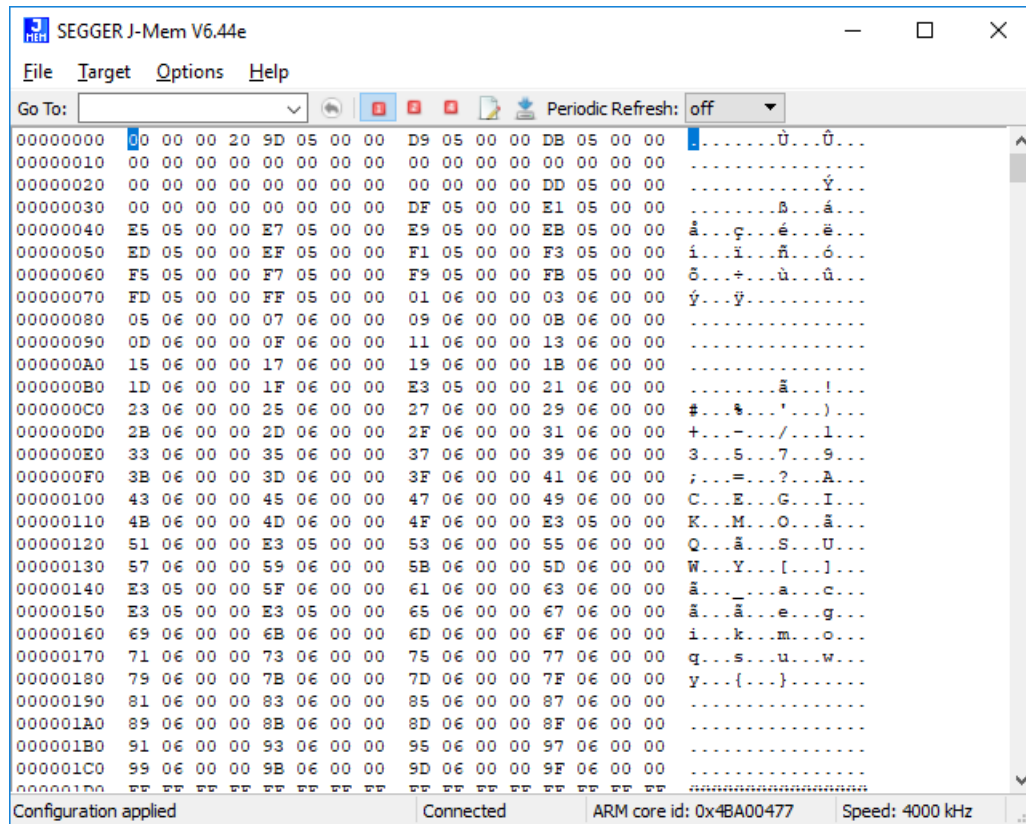

J-Mem: UI

The memory window provides a range of different options regarding the displayed memory.



J-Mem: Memory window options

In the following, these options are explained in detail from left to right (as seen in the screenshot above).

5.2.1 Go To

Using the “Go To” field, the first address shown in the memory window can be set. The button to the right of the edit-field returns to the previously selected address.

5.2.2 Access width

Using the red buttons to the right of the “Go To” field, the access width can be set. The number inside each button refers to the number of bytes that are accessed at once. This means that 1 refers to 8-bit access, 2 refers to 16-bit access and 4 refers to 32-bit access.

5.2.3 Fill memory

By clicking the icon next to the access width buttons, a range of memory can be filled with a custom value.

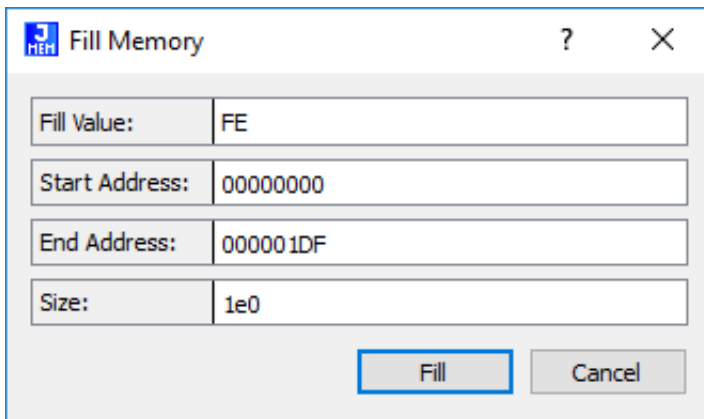

J-Mem: Fill memory

A custom *<Fill Value>* can be chosen that the selected memory region is filled with. The region to fill can be determined by setting the *<Start Address>* and either the *<End Address>* or *<Size>*.

5.2.4 Save memory data

The button to the right of the "Fill memory" icon makes it possible to save a memory range in a binary file.

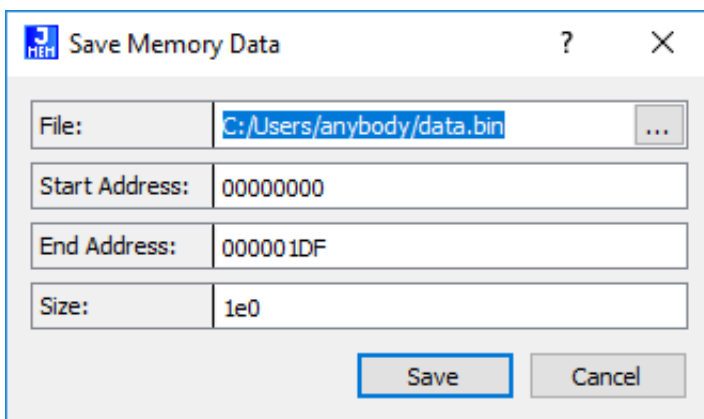

J-Mem: Save memory data

Similar to the "Fill memory" option, the memory region to be saved can be determined by setting the *<Start Address>* and either the *<End Address>* or *<Size>*.

5.2.5 Periodic Refresh

By default, J-Mem only reads the memory to be displayed once when it is shown for the first time. Using the "Periodic Refresh" option, a time interval for the refresh rate of the displayed data can be set.

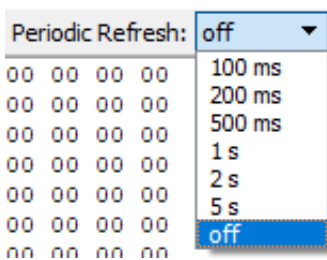

J-Mem: Periodic Refresh

One of the following intervals can be selected:

- 100 ms
- 200 ms
- 500 ms

- 1 s
- 2 s
- 5 s
- off

The time interval “off” is the default and does not refresh the displayed memory periodically.

5.2.6 Command line options

J-Mem has no command line options.

Chapter 6

Setup

This chapter describes the setup procedure required in order to work with J-Link / J-Trace. Primarily this includes the installation of the J-Link Software and Documentation Package, which also includes a kernel mode J-Link USB driver in your host system.

6.1 Installing the J-Link software and documentation pack

J-Link is shipped with a bundle of applications, corresponding manuals and some example projects and the kernel mode J-Link USB driver. Some of the applications require an additional license, free trial licenses are available upon request from www.segger.com. Refer to chapter *J-Link software and documentation package* on page 38 for an overview of the J-Link Software and Documentation Pack.

6.1.1 Setup procedure

To install the J-Link Software and Documentation Pack, follow this procedure:

Note

We recommend to check if a newer version of the J-Link Software and Documentation Pack is available for download before starting the installation. Check therefore the J-Link related download section of our website:
segger.com/jlink-software.html

The setup wizard will install the software and documentation pack that also includes the certified J-Link USB driver. Before you plug your J-Link / J-Trace into your computer's USB port, start the setup by double clicking Setup_JLinkARM_V<VersionNumber>.exe .

6.2 Setting up the USB interface

After installing the J-Link Software and Documentation Package it should not be necessary to perform any additional setup sequences in order to configure the USB interface of J-Link.

6.2.1 Verifying correct driver installation

To verify the correct installation of the driver, disconnect and reconnect J-Link / J-Trace to the USB port. During the enumeration process which takes about 2 seconds, the LED on J-Link / J-Trace is flashing. After successful enumeration, the LED stays on permanently. Start the provided sample application `JLink.exe`, which should display the compilation time of the J-Link firmware, the serial number, a target voltage of 0.000V, a complementary error message, which says that the supply voltage is too low if no target is connected to J-Link / J-Trace, and the speed selection. The screenshot below shows an example.

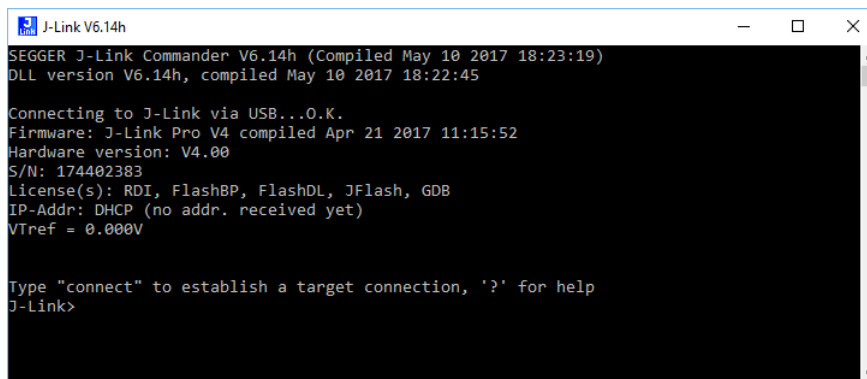

```
J-Link V6.14h
SEGGGER J-Link Commander V6.14h (Compiled May 10 2017 18:23:19)
DLL version V6.14h, compiled May 10 2017 18:22:45

Connecting to J-Link via USB...O.K.
Firmware: J-Link Pro V4 compiled Apr 21 2017 11:15:52
Hardware version: V4.00
S/N: 174402383
License(s): RDI, FlashBP, FlashDL, JFlash, GDB
IP-Addr: DHCP (no addr. received yet)
VTref = 0.000V

Type "connect" to establish a target connection, '?' for help
J-Link>
```

In addition you can verify the driver installation by consulting the Windows device manager. If the driver is installed and your J-Link / J-Trace is connected to your computer, the device manager should list the J-Link USB driver as a node below "Universal Serial Bus controllers" as shown in the following screenshot:

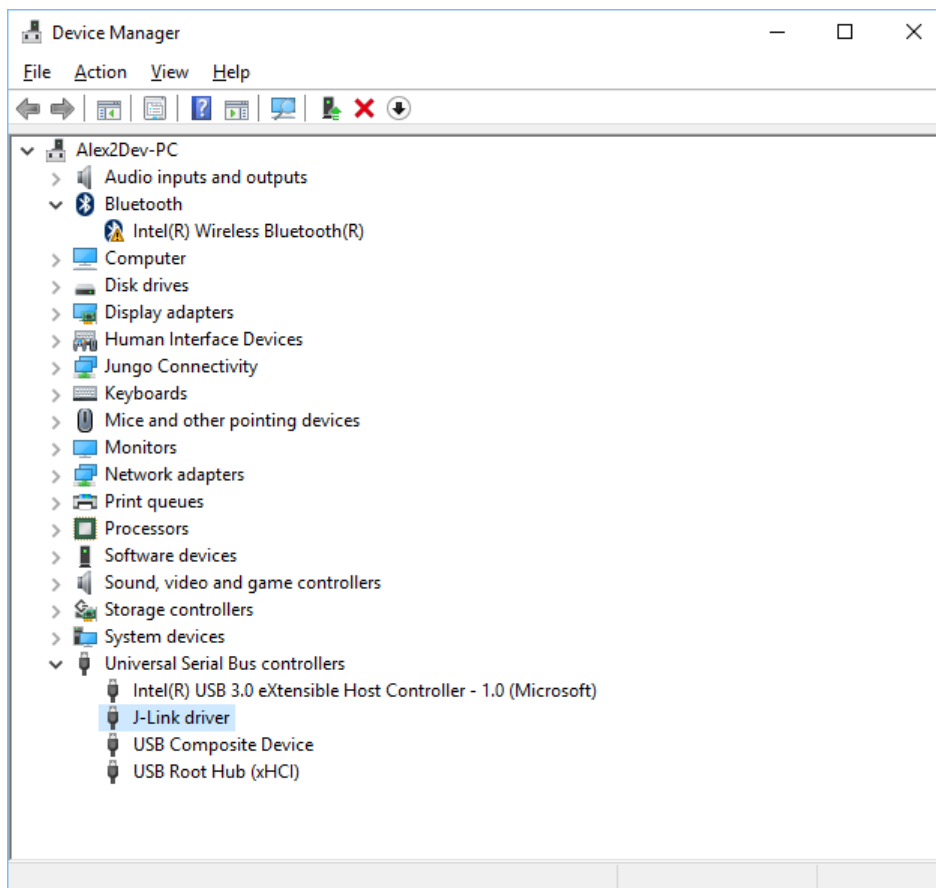

Right-click on the driver to open a context menu which contains the command Properties. If you select this command, a J-Link driver Properties dialog box is opened and should report: This device is working properly.

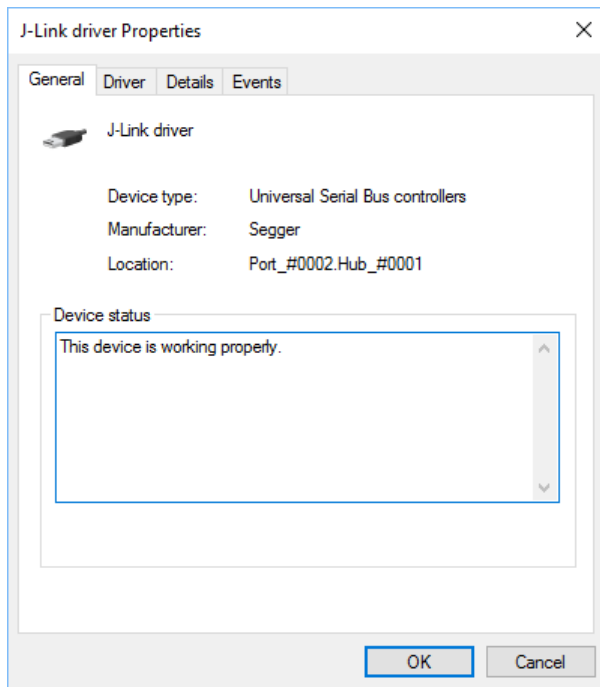

If you experience problems, refer to the chapter See Support and FAQs for help. You can select the Driver tab for detailed information about driver provider, version, date and digital signer.

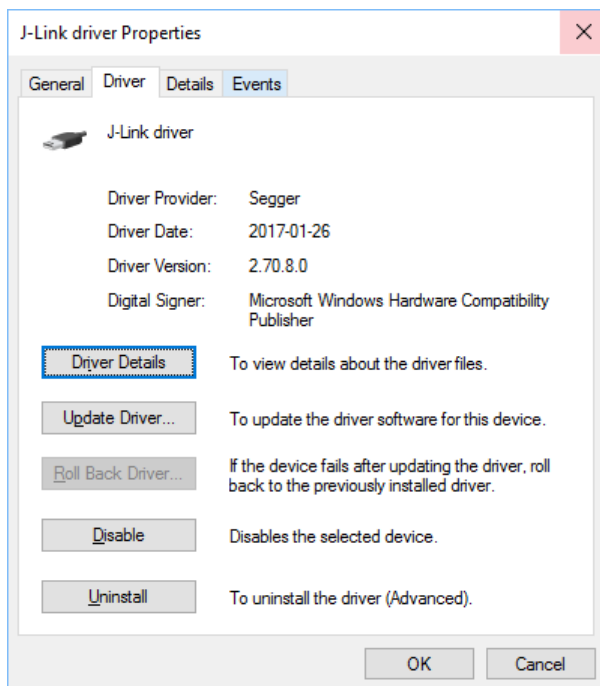

6.2.2 Uninstalling the J-Link USB driver

If J-Link / J-Trace is not properly recognized by Windows and therefore does not enumerate, it makes sense to uninstall the J-Link USB driver. This might be the case when:

- The LED on the J-Link / J-Trace is rapidly flashing.
- The J-Link / J-Trace is recognized as Unknown Device by Windows.

To have a clean system and help Windows to reinstall the J-Link driver, follow this procedure:

1. Disconnect J-Link / J-Trace from your PC.
2. Open the Add/Remove Programs dialog (Start > Settings > Control Panel > Add/Remove Programs) select Windows Driver Package - Segger (jlink) USB and click the Change/Remove button.

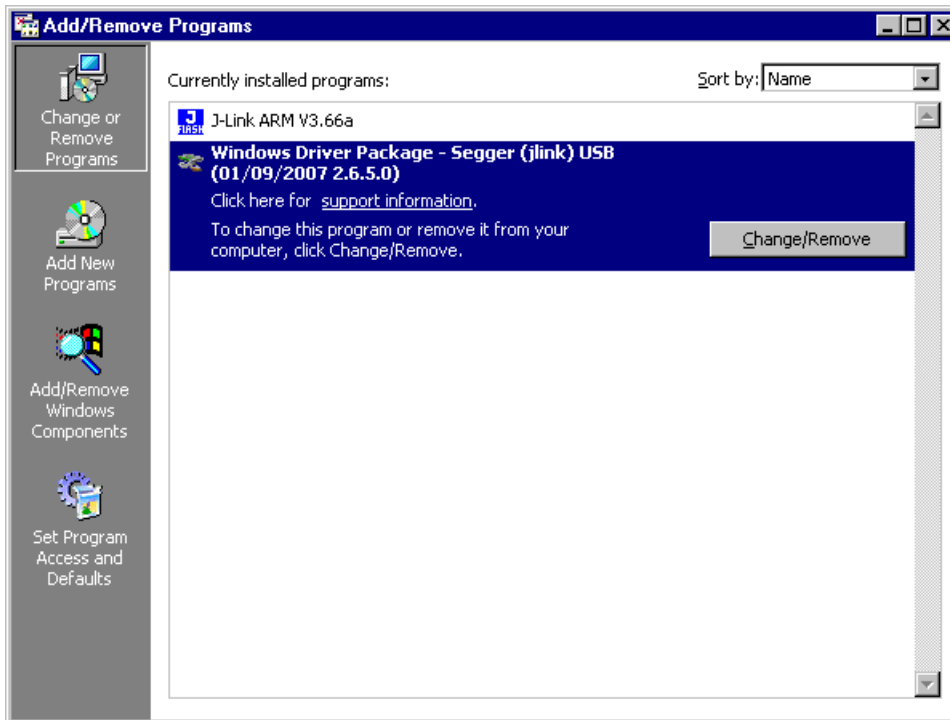

3. Confirm the uninstallation process.

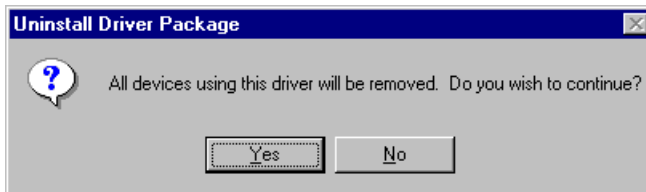

6.3 Setting up the IP interface

Some emulators of the J-Link family have (or future members will have) an additional Ethernet interface, to communicate with the host system. These emulators will also come with a built-in web server which allows configuration of the emulator via web interface. In addition to that, you can set a default gateway for the emulator which allows using it even in large intranets. For simplicity the setup process of J-Link Pro (referred to as J-Link) is described in this section.

6.3.1 Configuring J-Link using J-Link Configurator

The J-Link Software and Documentation Package comes with a free GUI-based utility called J-Link Configurator which auto-detects all J-Links that are connected to the host PC via USB & Ethernet. The J-Link Configurator allows the user to setup the IP interface of J-Link. For more information about how to use the J-Link Configurator, please refer to *J-Link Configurator* .

6.3.2 Configuring J-Link using the webinterface

All emulators of the J-Link family which come with an Ethernet interface also come with a built-in web server, which provides a web interface for configuration. This enables the user to configure J-Link without additional tools, just with a simple web browser. The Home page of the web interface shows the serial number, the current IP address and the MAC address of the J-Link.

The screenshot displays the web interface for the J-Link Pro. At the top, there is a blue header bar with the SEGGER logo on the left, the text 'J-Link Pro Webserver' in the center, and 'SEGGER Microcontroller' on the right. Below the header, the main content area is titled 'Home'. On the left side, there is a vertical sidebar with several blue links: 'Home', 'Network information', 'Network configuration', 'System information', 'Emulator status', and 'About'. The main content area contains the following information:

- Emulator information:**
 - Firmware build: Dec 22 2008 09:24:26
 - Serial Number: [redacted]
- Network information:**
 - Configuration type: User assigned
 - IP Address: 192.168.90.11 /16
 - Gateway: 192.168.1.1

On the right side of the main content area, there is a photograph of the J-Link Pro hardware device, which is a small black rectangular board with a USB connector at the bottom and two Ethernet ports at the top.

The Network configuration page allows configuration of network related settings (IP address, subnet mask, default gateway) of J-Link. The user can choose between automatic IP assignment (settings are provided by a DHCP server in the network) and manual IP assignment by selecting the appropriate radio button.

J-Link Pro WebserverSEGGER Microcontroller

[Home](#)
[Network information](#)
[Network configuration](#)
[System information](#)
[Emulator status](#)
[About](#)

Network configuration

Automatic Manual

DHCP

IP address: . . .

Subnet mask: . . .

Gateway: . . .

6.4 FAQs

Q: How can I use J-Link with GDB and Ethernet?

A: You have to use the J-Link GDB Server in order to connect to J-Link via GDB and Ethernet.

6.5 J-Link Configurator

Normally, no configuration is required, especially when using J-Link via USB. For special cases like having multiple older J-Links connected to the same host PC in parallel, they need to be re-configured to be identified by their real serial number when enumerating on the host PC. This is the default identification method for current J-Links (J-Link with hardware version 8 or later). For re-configuration of old J-Links or for configuration of the IP settings (use DHCP, IP address, subnet mask, ...) of a J-Link supporting the Ethernet interface, SEGGER provides a GUI-based tool, called J-Link Configurator. The J-Link Configurator is part of the J-Link Software and Documentation Package and can be used free of charge.

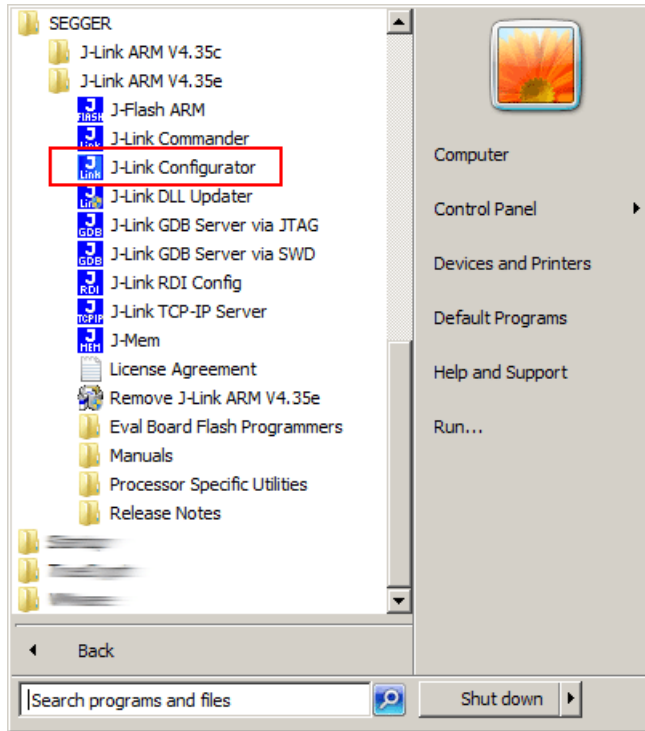

6.5.1 Configure J-Links using the J-Link Configurator

A J-Link can be easily configured by selecting the appropriate J-Link from the emulator list and using right click -> Configure.

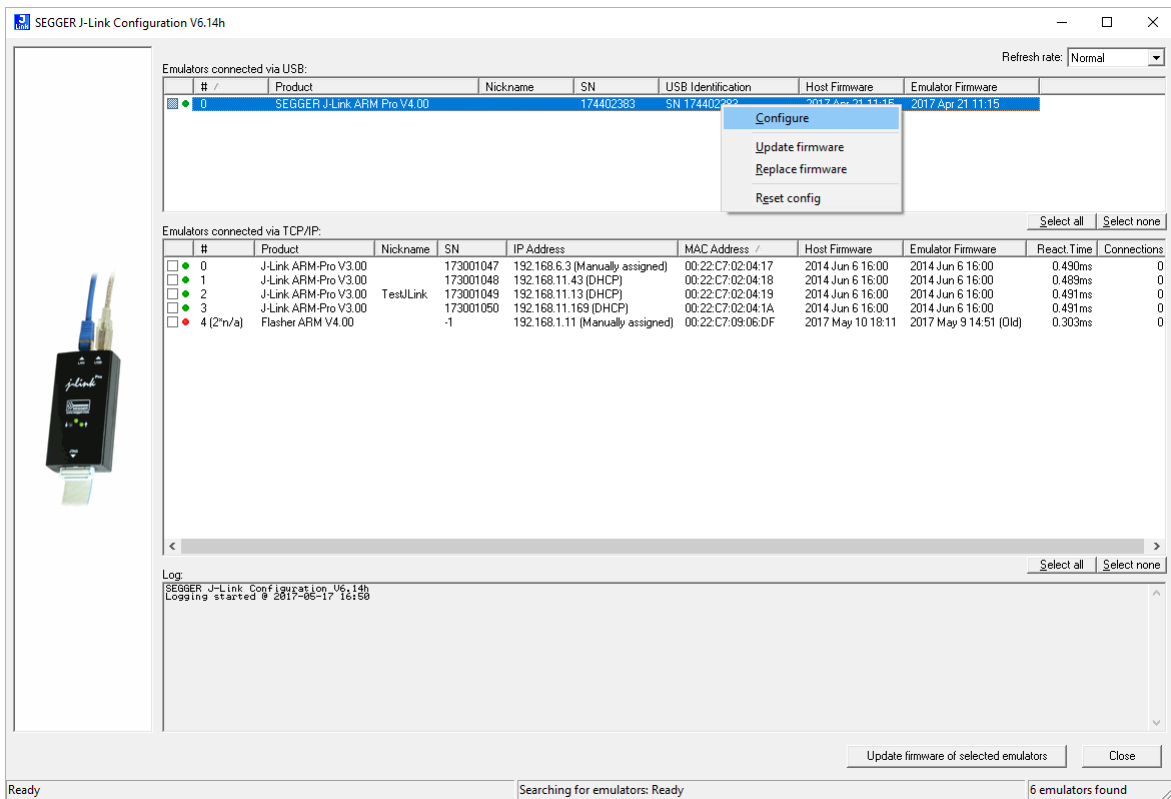

In order to configure an old J-Link, which uses the old USB 0 - 3 USB identification method, to use the new USB identification method (reporting the real serial number) simply select "Real SN" as USB identification method and click the OK button. The same dialog also allows configuration of the IP settings of the connected J-Link if it supports the Ethernet interface.

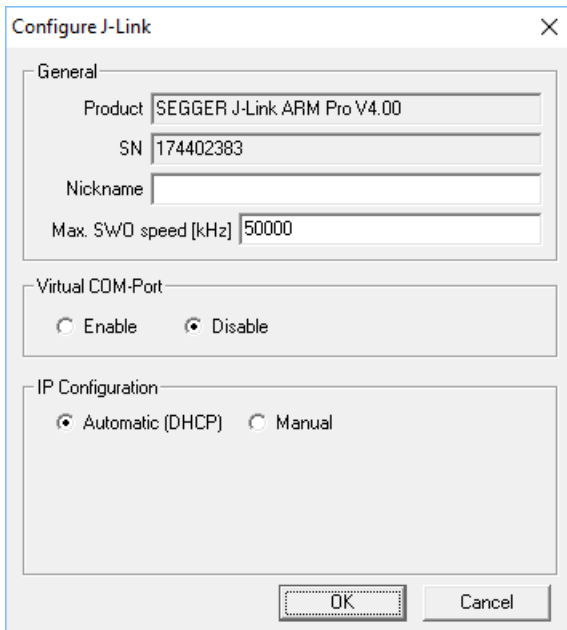

6.6 J-Link USB identification

In general, when using USB, there are two ways in which a J-Link can be identified:

- By serial number
- By USB address

Default configuration of J-Link is: Identification by serial number. Identification via USB address is used for compatibility and not recommended.

Background information

“USB address” really means changing the USB-Product ID (PID). The following table shows how J-Links enumerate in the different identification modes.

Identification	PID	Serial number
Serial number (default)	0x0101	Serial number is real serial number of the J-Link or user assigned.
USB address 0 (Deprecated)	0x0101	123456
USB address 1 (Deprecated)	0x0102	123456
USB address 2 (Deprecated)	0x0103	123456
USB address 3 (Deprecated)	0x0104	123456

6.6.1 Connecting to different J-Links connected to the same host PC via USB

In general, when having multiple J-Links connected to the same PC, the J-Link to connect to is explicitly selected by its serial number. Most software/debuggers provide an extra field to type-in the serial number of the J-Link to connect to.

A debugger / software which does not provide such a functionality, the J-Link DLL automatically detects that multiple J-Links are connected to the PC and shows a selection dialog which allows the user to select the appropriate J-Link to connect to.

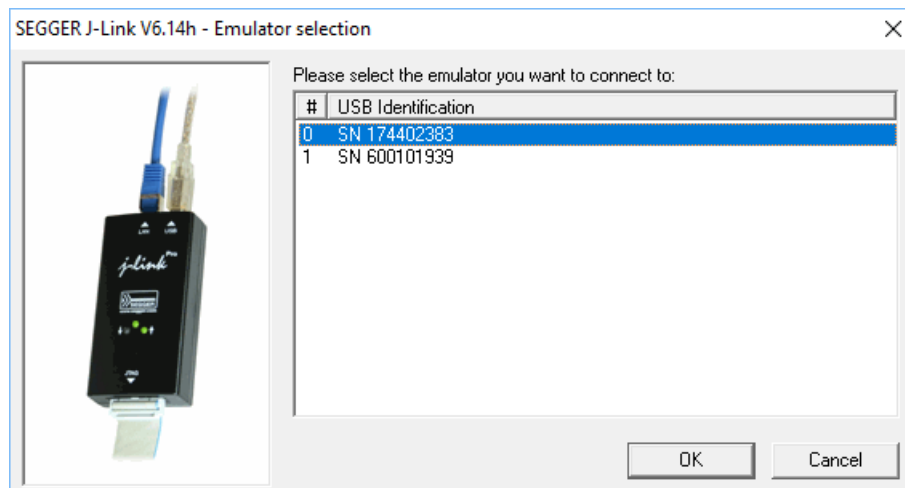

So even in IDEs which do not have an selection option for the J-Link, it is possible to connect to different J-Links.

6.7 Using the J-Link DLL

6.7.1 What is the JLink DLL?

The J-LinkARM.dll is a standard Windows DLL typically used from C or C++, but also Visual Basic or Delphi projects. It makes the entire functionality of the J-Link / J-Trace available through the exported functions. The functionality includes things such as halting/stepping the ARM core, reading/writing CPU and ICE registers and reading/writing memory. Therefore, it can be used in any kind of application accessing a CPU core.

6.7.2 Updating the DLL in third-party programs

The JLink DLL can be used by any debugger that is designed to work with it. Some debuggers are usually shipped with the J-Link DLL already installed. Anyhow it may make sense to replace the included DLL with the latest one available, to take advantage of improvements in the newer version.

6.7.2.1 Updating the J-Link DLL in the IAR Embedded Workbench for ARM (EWARM)

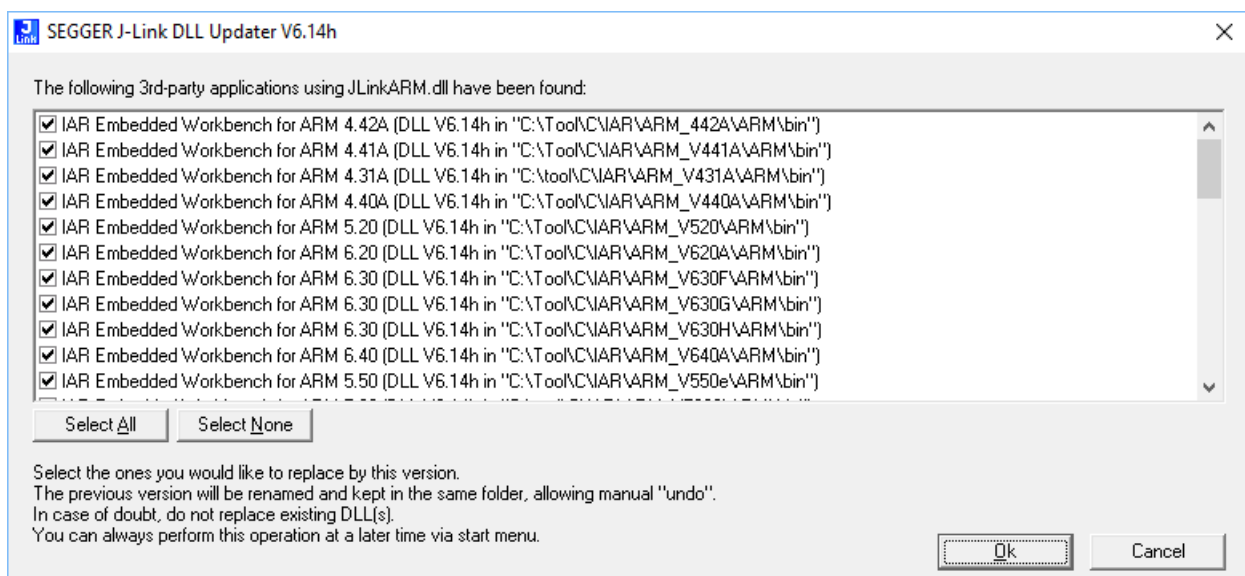

6.7.3 Determining the version of JLink DLL

To determine which version of the JLinkARM.dll you are using, the DLL version can be viewed by right clicking the DLL in explorer and choosing Properties from the context menu. Click the Version tab to display information about the product version.

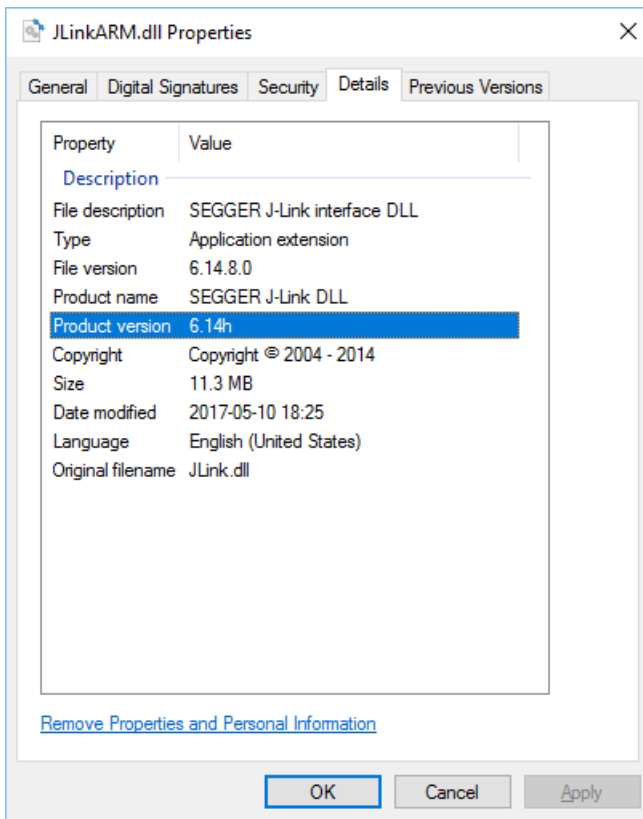

6.7.4 Determining which DLL is used by a program

To verify that the program you are working with is using the DLL you expect it to use, you can investigate which DLLs are loaded by your program with tools like Sysinternals' Process Explorer. It shows you details about the DLLs used by your program, such as manufacturer and version.

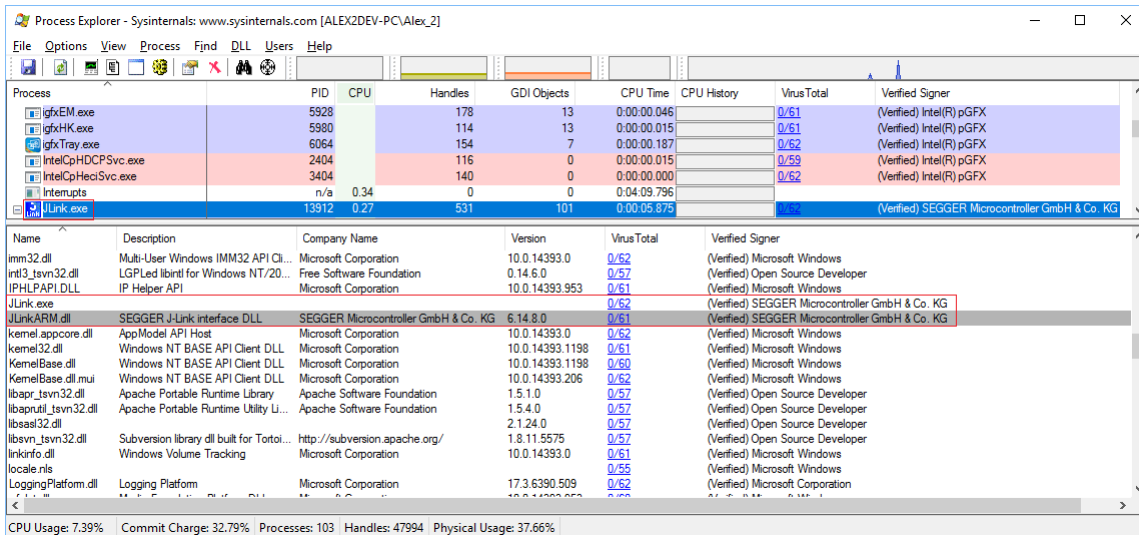

Process Explorer is - at the time of writing - a free utility which can be downloaded from www.sysinternals.com.

Chapter 7

Working with J-Link and J-Trace

This chapter describes functionality and how to use J-Link and J-Trace.

7.1 Supported IDEs

J-Link supports almost all popular IDEs available today. If support for a IDE is lacking, feel free to get in contact with SEGGER. (see *Contact Information*)

For a list of supported 3rd-party debuggers and IDEs and documentation on how to get started with those IDEs and J-Link / J-Trace es well as on how to use the advanced features of J-Link / J-Trace with any of them, please refer to:

[SEGGER Wiki: Getting Started with Various IDEs](#) and
[List of supported IDEs](#)

7.2 Connecting the target system

7.2.1 Power-on sequence

In general, J-Link / J-Trace should be powered on before connecting it with the target device. That means you should first connect J-Link / J-Trace with the host system via USB and then connect J-Link / J-Trace with the target device via JTAG. Power-on the device after you connected J-Link / J-Trace to it.

7.2.2 Verifying target device connection

If the USB driver is working properly and your J-Link / J-Trace is connected with the host system, you may connect J-Link / J-Trace to your target hardware. Then start JLink.exe which should now display the normal J-Link / J-Trace related information and in addition to that it should report that it found a JTAG target and the target's core ID. The screenshot below shows the output of JLink.exe . As can be seen, it reports a J-Link with one JTAG device connected.

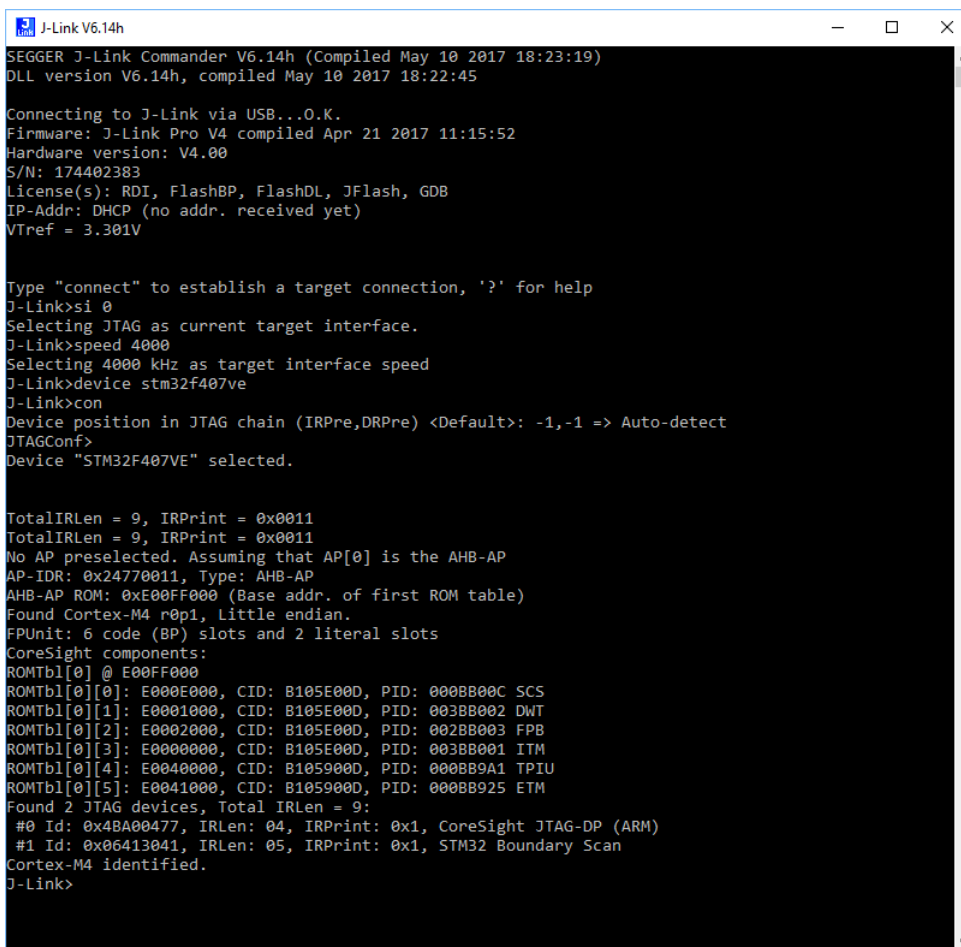

```

J-Link V6.14h
SEGGER J-Link Commander V6.14h (Compiled May 10 2017 18:23:19)
DLL version V6.14h, compiled May 10 2017 18:22:45

Connecting to J-Link via USB...O.K.
Firmware: J-Link Pro V4 compiled Apr 21 2017 11:15:52
Hardware version: V4.00
S/N: 174402383
License(s): RDI, FlashBP, FlashDL, JFlash, GDB
IP-Addr: DHCP (no addr. received yet)
VTref = 3.301V

Type "connect" to establish a target connection, '?' for help
J-Link>si 0
Selecting JTAG as current target interface.
J-Link>speed 4000
Selecting 4000 kHz as target interface speed
J-Link>device stm32f407ve
J-Link>con
Device position in JTAG chain (IRPre,DRPre) <Default>: -1,-1 => Auto-detect
JTAGConf>
Device "STM32F407VE" selected.

TotalIRLen = 9, IRPrint = 0x0011
TotalIRLen = 9, IRPrint = 0x0011
No AP preselected. Assuming that AP[0] is the AHB-AP
AP-IDR: 0x24770011, Type: AHB-AP
AHB-AP ROM: 0xE00FF000 (Base addr. of first ROM table)
Found Cortex-M4 r0p1, Little endian.
FPUnit: 6 code (BP) slots and 2 literal slots
CoreSight components:
ROMTbl[0] @ E00FF000
ROMTbl[0][0]: E000E000, CID: B105E00D, PID: 000BB00C SCS
ROMTbl[0][1]: E0001000, CID: B105E00D, PID: 003BB002 DWT
ROMTbl[0][2]: E0002000, CID: B105E00D, PID: 002BB003 FPB
ROMTbl[0][3]: E0000000, CID: B105E00D, PID: 003BB001 ITM
ROMTbl[0][4]: E0040000, CID: B105900D, PID: 000BB9A1 TPIU
ROMTbl[0][5]: E0041000, CID: B105900D, PID: 000BB925 ETM
Found 2 JTAG devices, Total IRLen = 9:
#0 Id: 0x4BA00477, IRLen: 04, IRPrint: 0x1, CoreSight JTAG-DP (ARM)
#1 Id: 0x06413041, IRLen: 05, IRPrint: 0x1, STM32 Boundary Scan
Cortex-M4 identified.
J-Link>

```

7.2.3 Problems

If you experience problems with any of the steps described above, read the chapter *Support and FAQs* for troubleshooting tips. If you still do not find appropriate help there and your J-Link / J-Trace is an original SEGGER product, you can contact SEGGER support via e-mail. Provide the necessary information about your target processor, board etc. and we will try to solve your problem. A checklist of the required information together with the contact information can be found in chapter *Support and FAQs* as well.

7.3 Indicators

J-Link uses indicators (LEDs) to give the user some information about the current status of the connected J-Link. All J-Links feature the main indicator. Some newer J-Links such as the J-Link Pro / Ultra come with additional input/output Indicators. In the following, the meaning of these indicators will be explained.

7.3.1 Main indicator

For J-Links up to V7, the main indicator is single color (Green). J-Link V8 comes with a bi-color indicator (Green & Red LED), which can show multiple colors: green, red and orange.

7.3.1.1 Single color indicator (J-Link V7 and earlier)

Indicator status	Meaning
GREEN, flashing at 10 Hz	Emulator enumerates.
GREEN, flickering	Emulator is in operation. Whenever the emulator is executing a command, the LED is switched off temporarily. Flickering speed depends on target interface speed. At low interface speeds, operations typically take longer and the "OFF" periods are typically longer than at fast speeds.
GREEN, constant	Emulator has enumerated and is in idle mode.
GREEN, switched off for 10ms once per second	J-Link heart beat. Will be activated after the emulator has been in idle mode for at least 7 seconds.
GREEN, flashing at 1 Hz	Emulator has a fatal error. This should not normally happen.

7.3.1.2 Bi-color indicator (J-Link V8)

Indicator status	Meaning
GREEN, flashing at 10 Hz	Emulator enumerates.
GREEN, flickering	Emulator is in operation. Whenever the emulator is executing a command, the LED is switched off temporarily. Flickering speed depends on target interface speed. At low interface speeds, operations typically take longer and the "OFF" periods are typically longer than at fast speeds.
GREEN, constant	Emulator has enumerated and is in idle mode.
GREEN, switched off for 10ms once per second	J-Link heart beat. Will be activated after the emulator has been in idle mode for at least 7 seconds.
ORANGE	Reset is active on target.
RED, flashing at 1 Hz	Emulator has a fatal error. This should not normally happen.

7.3.2 Input indicator

Some newer J-Links such as the J-Link Pro/Ultra come with additional input/output indicators. The input indicator is used to give the user some information about the status of the target hardware.

7.3.2.1 Bi-color input indicator

Indicator status	Meaning
GREEN	Target voltage could be measured. Target is connected.
ORANGE	Target voltage could be measured. RESET is pulled low (active) on target side.

Indicator status	Meaning
RED	RESET is pulled low (active) on target side. If no target is connected, reset will also be active on target side.

7.3.3 Output indicator

Some newer J-Links such as the J-Link Pro/Ultra come with additional input/output indicators. The output indicator is used to give the user some information about the emulator-to-target connection.

7.3.3.1 Bi-color output indicator

Indicator status	Meaning
OFF	Target power supply via Pin 19 is not active.
GREEN	Target power supply via Pin 19 is active.
ORANGE	Target power supply via Pin 19 is active. Emulator pulls RESET low (active).
RED	Emulator pulls RESET low (active).

7.4 JTAG interface

By default, only one device is assumed to be in the JTAG scan chain. If you have multiple devices in the scan chain, you must properly configure it. To do so, you have to specify the exact position of the CPU that should be addressed. Configuration of the scan is done by the target application. A target application can be a debugger such as the IAR C-SPY® debugger, ARM's AXD using RDI, a flash programming application such as SEGGER's J-Flash, or any other application using J-Link / J-Trace. It is the application's responsibility to supply a way to configure the scan chain. Most applications offer a dialog box for this purpose.

7.4.1 Multiple devices in the scan chain

J-Link / J-Trace can handle multiple devices in the scan chain. This applies to hardware where multiple chips are connected to the same JTAG connector. As can be seen in the following figure, the TCK and TMS lines of all JTAG device are connected, while the TDI and TDO lines form a bus.

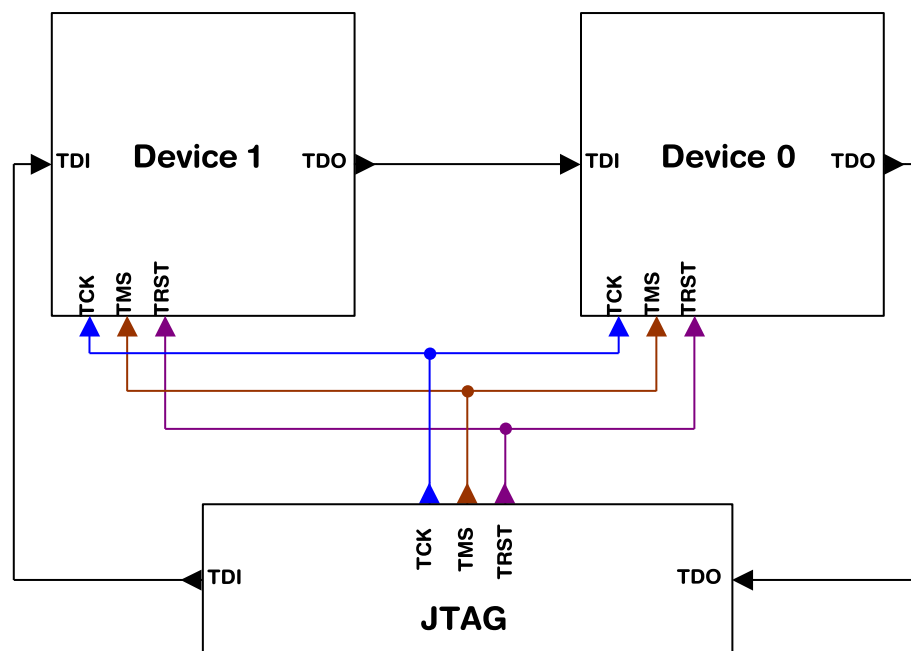

Currently, up to 8 devices in the scan chain are supported. One or more of these devices can be CPU cores; the other devices can be of any other type but need to comply with the JTAG standard.

7.4.1.1 Configuration

The configuration of the scan chain depends on the application used. Read *JTAG interface* for further instructions and configuration examples.

7.4.2 Sample configuration dialog boxes

As explained before, it is the responsibility of the application to allow the user to configure the scan chain. This is typically done in a dialog box; some sample dialog boxes are shown below.

SEGGER J-Flash configuration dialog

This dialog box can be found at Options|Project settings.

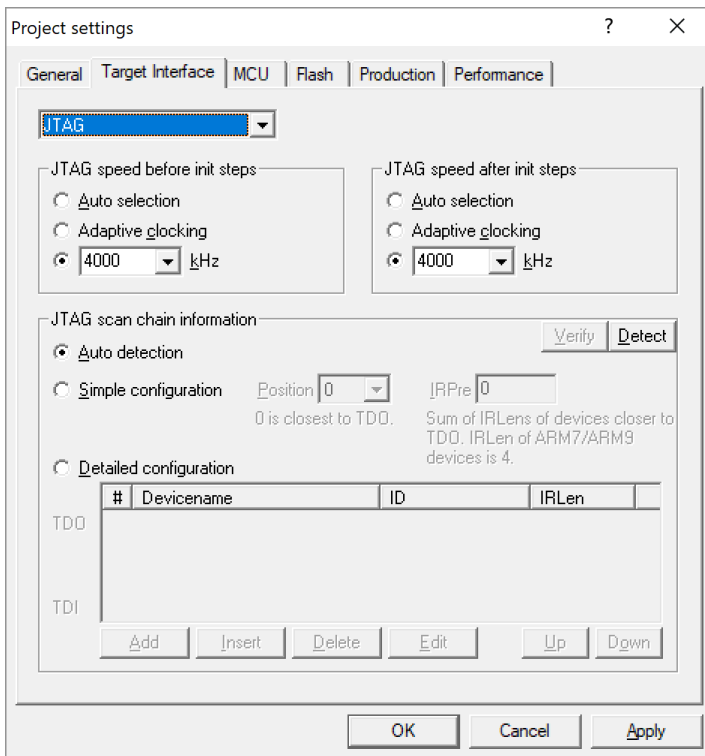

SEGGER J-Link RDI configuration dialog box

This dialog can be found under RDI|Configure for example in IAR Embedded Workbench®. For detailed information check the IAR Embedded Workbench user guide.

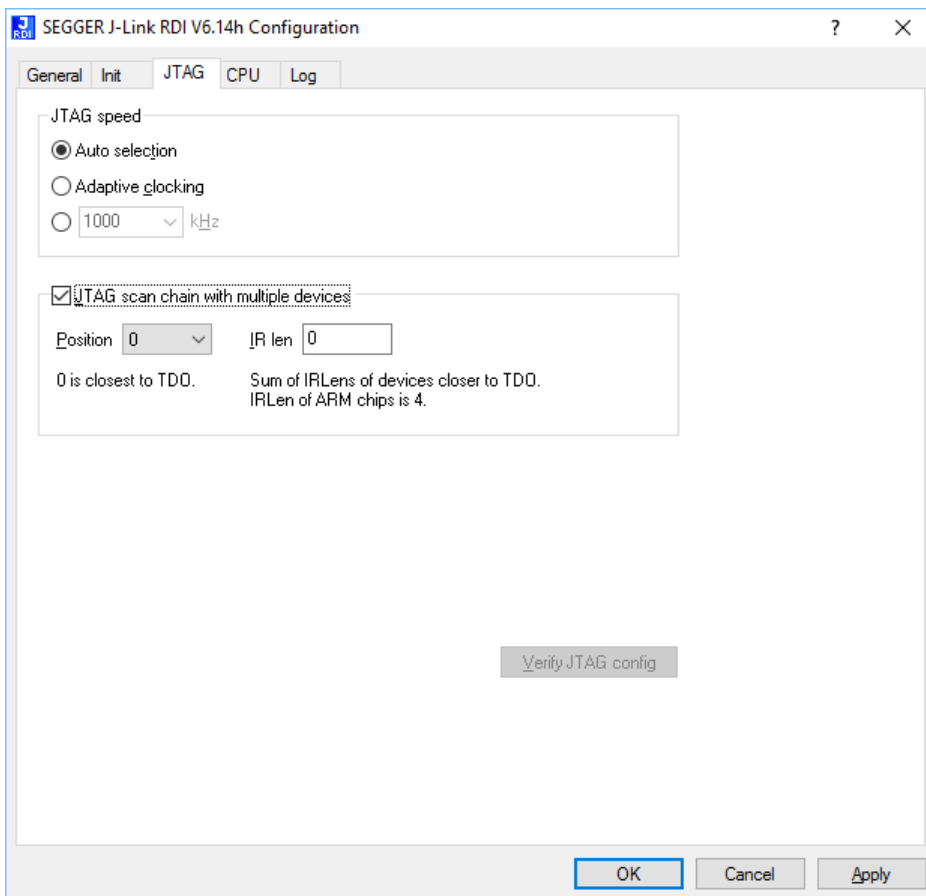

7.4.3 Determining values for scan chain configuration

If only one device is connected to the scan chain, the default configuration can be used. In other cases, J-Link / J-Trace may succeed in automatically recognizing the devices on the scan chain, but whether this is possible depends on the devices present on the scan chain.

How do I configure the scan chain?

2 values need to be known:

- The position of the target device in the scan chain.
- The total number of bits in the instruction registers of the devices before the target device (IR len).

The position can usually be seen in the schematic; the IR len can be found in the manual supplied by the manufacturers of the others devices. ARM7/ARM9 have an IR len of four.

Sample configurations

The diagram below shows a scan chain configuration sample with 2 devices connected to the JTAG port.

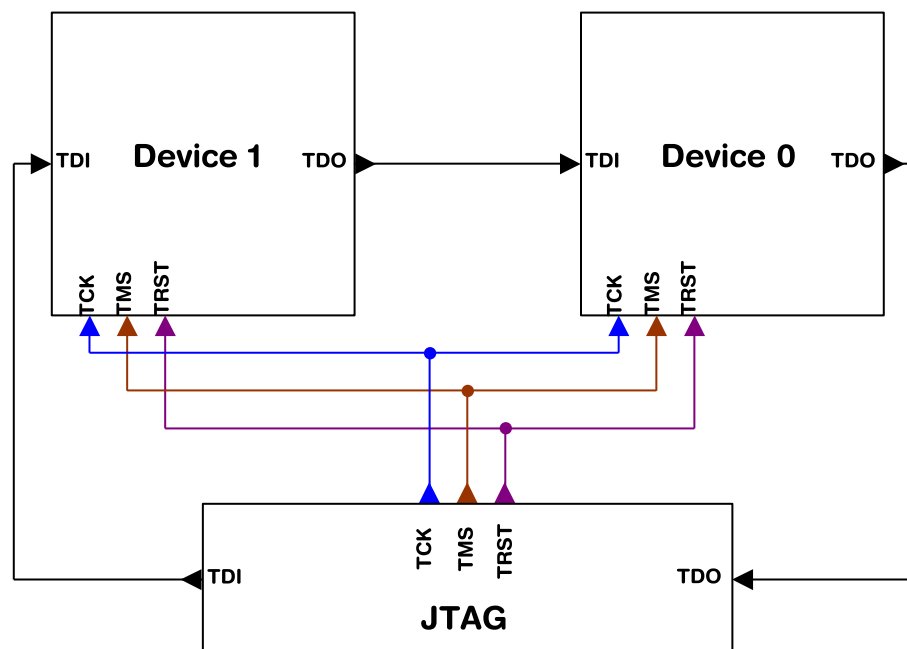

Examples

The following table shows a few sample configurations with 1, 2 and 3 devices in different configurations.

Device 0 Chip(IR len)	Device 1 Chip(IR len)	Device 2 Chip(IR len)	Position	IR len
ARM(4)	-	-	0	0
ARM(4)	Xilinx(8)	-	0	0
Xilinx(8)	ARM(4)	-	1	8
Xilinx(8)	Xilinx(8)	ARM(4)	2	16
ARM(4)	Xilinx(8)	ARM(4)	0	0
ARM(4)	Xilinx(8)	ARM(4)	2	12
Xilinx(8)	ARM(4)	Xilinx(8)	1	8

The target device is marked in blue.

7.4.4 JTAG Speed

There are basically three types of speed settings:

- Fixed JTAG speed.
- Automatic JTAG speed.
- Adaptive clocking. These are explained below.

7.4.4.1 Fixed JTAG speed

The target is clocked at a fixed clock speed. The maximum JTAG speed the target can handle depends on the target itself. In general CPU cores without JTAG synchronization logic (such as ARM7-TDMI) can handle JTAG speeds up to the CPU speed, ARM cores with JTAG synchronization logic (such as ARM7-TDMI-S, ARM946E-S, ARM966EJ-S) can handle JTAG speeds up to 1/6 of the CPU speed. JTAG speeds of more than 10 MHz are not recommended.

7.4.4.2 Automatic JTAG speed

Selects the maximum JTAG speed handled by the TAP controller.

Note

On ARM cores without synchronization logic, this may not work reliably, because the CPU core may be clocked slower than the maximum JTAG speed.

7.4.4.3 Adaptive clocking

If the target provides the RTCK signal, select the adaptive clocking function to synchronize the clock to the processor clock outside the core. This ensures there are no synchronization problems over the JTAG interface. If you use the adaptive clocking feature, transmission delays, gate delays, and synchronization requirements result in a lower maximum clock frequency than with non-adaptive clocking.

7.5 SWD interface

The J-Link support ARMs Serial Wire Debug (SWD). SWD replaces the 5-pin JTAG port with a clock (SWDCLK) and a single bi-directional data pin (SWDIO), providing all the normal JTAG debug and test functionality. SWDIO and SWCLK are overlaid on the TMS and TCK pins. In order to communicate with a SWD device, J-Link sends out data on SWDIO, synchronous to the SWCLK. With every rising edge of SWCLK, one bit of data is transmitted or received on the SWDIO.

7.5.1 SWD speed

Currently only fixed SWD speed is supported by J-Link. The target is clocked at a fixed clock speed. The SWD speed which is used for target communication should not exceed target CPU speed * 10 . The maximum SWD speed which is supported by J-Link depends on the hardware version and model of J-Link. For more information about the maximum SWD speed for each J-Link / J-Trace model, please refer to *J-Link / J-Trace models* on page 33.

7.5.2 SWO

Serial Wire Output (SWO) support means support for a single pin output signal from the core. The Instrumentation Trace Macrocell (ITM) and Serial Wire Output (SWO) can be used to form a Serial Wire Viewer (SWV). The Serial Wire Viewer provides a low cost method of obtaining information from inside the MCU. Usually it should not be necessary to configure the SWO speed because this is usually done by the debugger.

7.5.2.1 Max. SWO speeds

The supported SWO speeds depend on the connected emulator. They can be retrieved from the emulator. To get the supported SWO speeds for your emulator, use J-Link Commander:

```
J-Link> si 1 //Select target interface SWD
J-Link> SWOSpeed
```

Currently, following speeds are supported:

Emulator	Speed formula	Resulting max. speed
J-Link V9	60MHz/n, n ≥ 8	7.5 MHz
J-Link Pro/ULTRA V4	3.2GHz/n, n ≥ 64	50 MHz

7.5.2.2 Configuring SWO speeds

The max. SWO speed in practice is the max. speed which both, target and J-Link can handle. J-Link can handle the frequencies described in *SWO* whereas the max. deviation between the target and the J-Link speed is about 3%. The computation of possible SWO speeds is typically done in the debugger. The SWO output speed of the CPU is determined by TRACECLKIN, which is normally the same as the CPU clock.

Example 1

```
Target CPU running at 72 MHz. n is between 1 and 8192.
Possible SWO output speeds are:
72MHz, 36MHz, 24MHz, ...
J-Link V9: Supported SWO input speeds are: 60MHz / n, n>= 8:
7.5MHz, 6.66MHz, 6MHz, ...
```

Permitted combinations are:

SWO output	SWO input	Deviation percent
6MHz, n = 12	6MHz, n = 10	0

SWO output	SWO input	Deviation percent
4MHz, n = 18	4MHz, n = 15	0
...	...	≤ 3
2MHz, n = 36	2MHz, n = 30	0
...
TEXT	TEXT	TEXT
TEXT	TEXT	TEXT
TEXT	TEXT	TEXT
TEXT	TEXT	TEXT

Example 2

```

Target CPU running at 10 MHz.
Possible SWO output speeds are:
10MHz, 5MHz, 3.33MHz, ...
J-Link V7: Supported SWO input speeds are: 6MHz / n, n>= 1:
6MHz, 3MHz, 2MHz, 1.5MHz, ...

```

Permitted combinations are:

SWO output	SWO input	Deviation percent
2MHz, n = 5	2MHz, n = 3	0
1MHz, n = 10	1MHz, n = 6	0
769kHz, n = 13	750kHz, n = 8	2.53
...

7.6 Multi-core debugging

J-Link / J-Trace is able to debug multiple cores on one target system connected to the same scan chain. Configuring and using this feature is described in this section.

7.6.1 How multi-core debugging works

Multi-core debugging requires multiple debuggers or multiple instances of the same debugger. Two or more debuggers can use the same J-Link / J-Trace simultaneously. Configuring a debugger to work with a core in a multi-core environment does not require special settings. All that is required is proper setup of the scan chain for each debugger. This enables J-Link / J-Trace to debug more than one core on a target at the same time. The following figure shows a host, debugging two CPU cores with two instances of the same debugger.

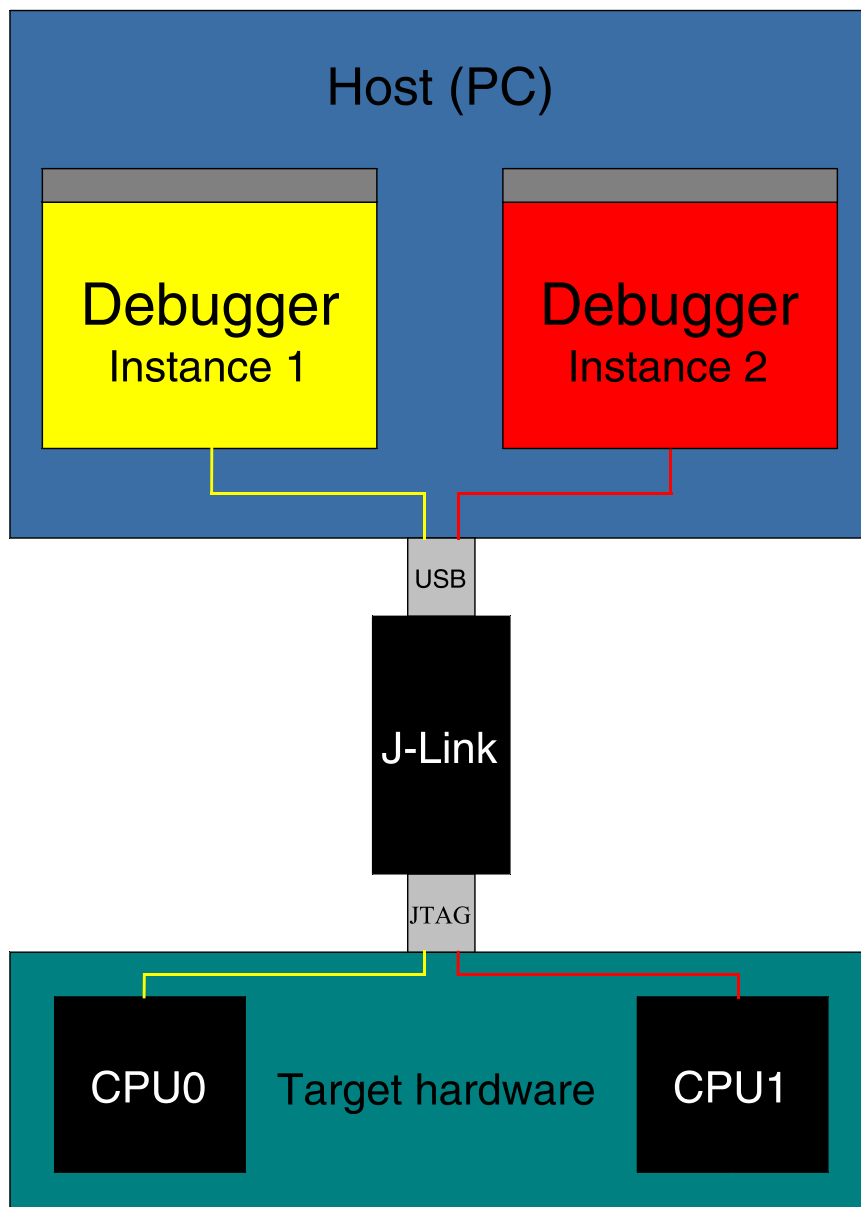

Both debuggers share the same physical connection. The core to debug is selected through the JTAG-settings as described below.

7.6.2 Using multi-core debugging in detail

1. Connect your target to J-Link / J-Trace.
2. Start your debugger, for example IAR Embedded Workbench for ARM.
3. Choose Project|Options and configure your scan chain. The picture below shows the configuration for the first CPU core on your target.

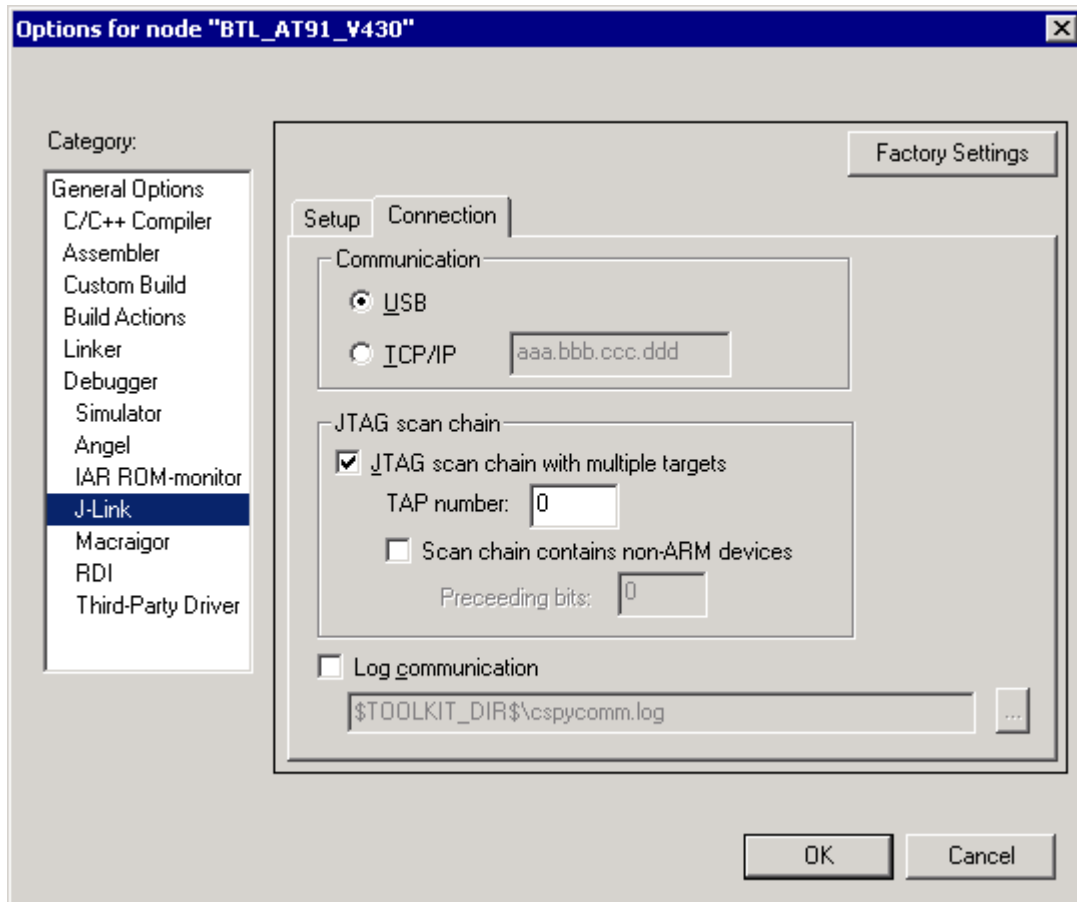

4. Start debugging the first core.
5. Start another debugger, for example another instance of IAR Embedded Workbench for ARM.
6. Choose Project|Options and configure your second scan chain. The following dialog box shows the configuration for the second ARM core on your target.

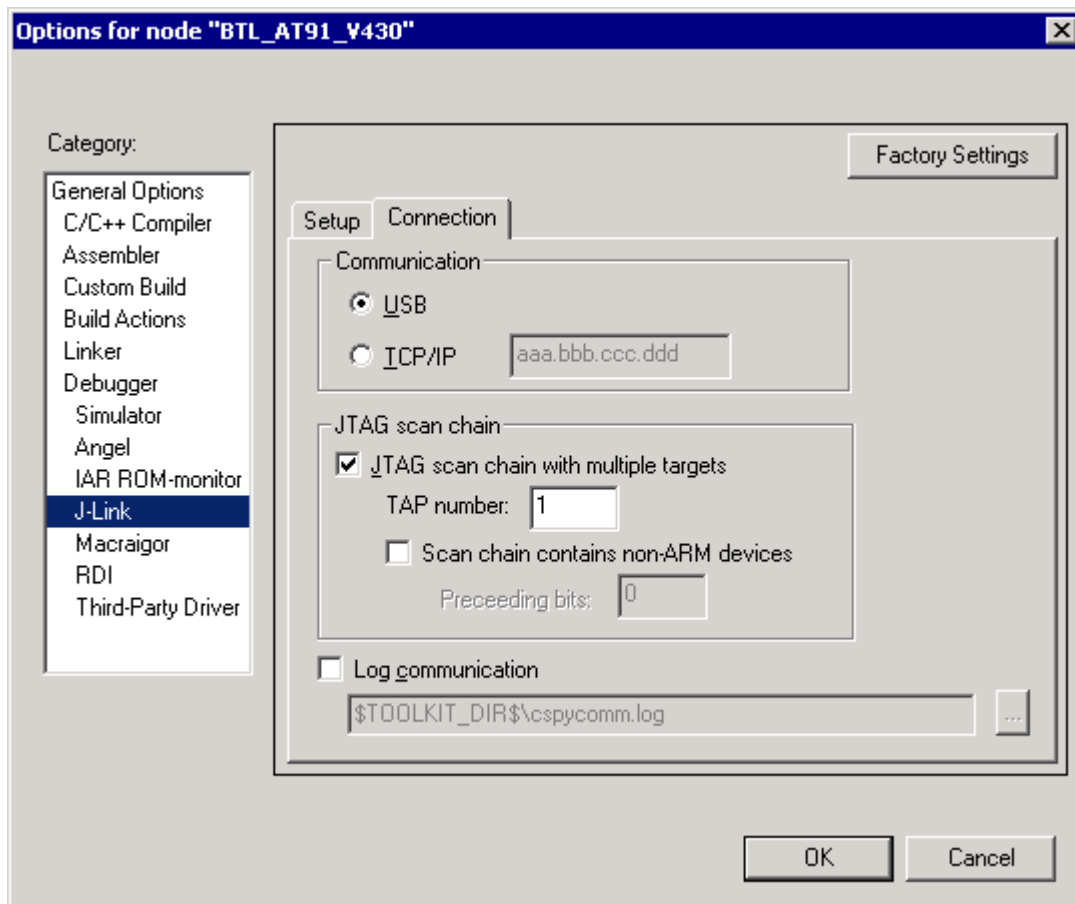

7. Start debugging your second core.

Core #1	Core #2	Core #3	TAP number debugger #1	TAP number debugger #2
ARM7TDMI	ARM7TDMI-S	ARM7TDMI	0	1
ARM7TDMI	ARM7TDMI	ARM7TDMI	0	2
ARM7TDMI-S	ARM7TDMI-S	ARM7TDMI-S	1	2

7.6.3 Things you should be aware of

Multi-core debugging is more difficult than single-core debugging. You should be aware of the pitfalls related to JTAG speed and resetting the target.

7.6.3.1 JTAG speed

Each core has its own maximum JTAG speed. The maximum JTAG speed of all cores in the same chain is the minimum of the maximum JTAG speeds. For example:

- Core #1: 2MHz maximum JTAG speed
- Core #2: 4MHz maximum JTAG speed
- Scan chain: 2MHz maximum JTAG speed

7.6.3.2 Resetting the target

All cores share the same RESET line. You should be aware that resetting one core through the RESET line means resetting all cores which have their RESET pins connected to the RESET line on the target.

7.7 Connecting multiple J-Links / J-Traces to your PC

In general, it is possible to have an unlimited number of J-Links / J-Traces connected to the same PC. Current J-Link models are already factory-configured to be used in a multi-J-Link environment, older J-Links can be re-configured to use them in a multi-J-link environment.

7.7.1 How does it work?

USB devices are identified by the OS by their product ID, vendor id and serial number. The serial number reported by current J-Links is a unique number which allows to have an almost unlimited number of J-Links connected to the same host at the same time. In order to connect to the correct J-Link, the user has to make sure that the correct J-Link is selected (by SN or IP). In cases where no specific J-Link is selected, following pop up will show and allow the user to select the proper J-Link:

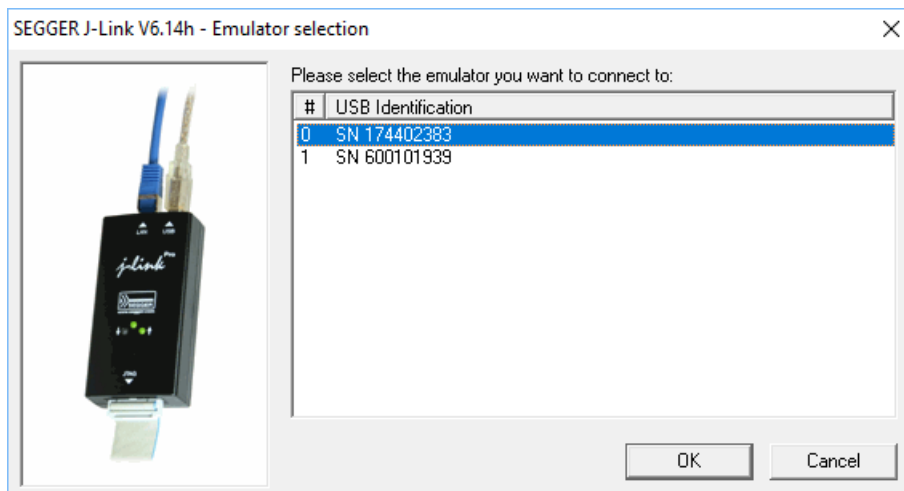

The sketch below shows a host, running two application programs. Each application communicates with one CPU core via a separate J-Link.

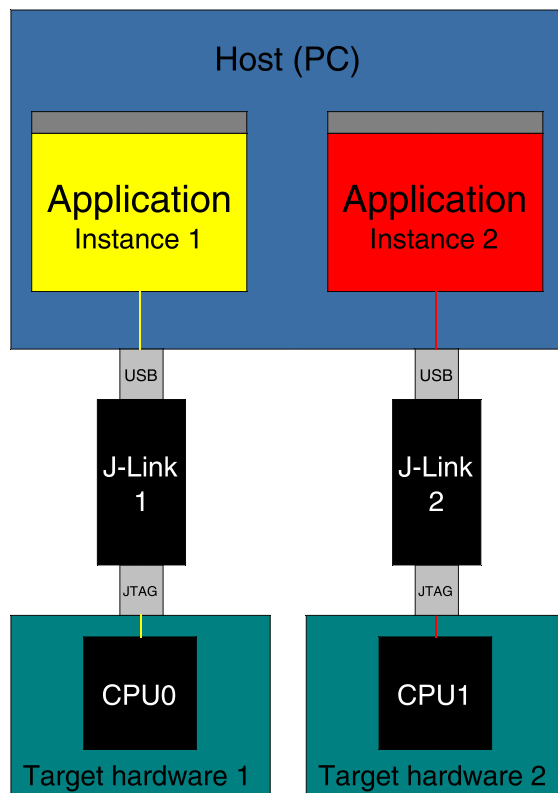

Older J-Links may report USB0-3 instead of unique serial number when enumerating via USB. For these J-Links, we recommend to re-configure them to use the new enumeration method (report real serial number) since the USB0-3 behavior is obsolete.

Re-configuration can be done by using the J-Link Configurator, which is part of the J-Link Software and Documentation Package. For further information about the J-Link Configurator and how to use it, please refer to *J-Link Configurator* .

Re-configuration to the old USB 0-3 enumeration method

In some special cases, it may be necessary to switch back to the obsolete USB 0-3 enumeration method. For example, old IAR EWARM versions supports connecting to a J-Link via the USB0-3 method only. As soon as more than one J-Link is connected to the pc, there is no opportunity to pre-select the J-Link which should be used for a debug session.

Below, a small instruction of how to re-configure J-Link to enumerate with the old obsolete enumeration method in order to prevent compatibility problems, a short instruction is give on how to set USB enumeration method to USB 2 is given:

Config area byte	Meaning
0	USB-Address. Can be set to 0-3, 0xFF is default which means USB-Address 0.
1	Enumeration method 0x00 / 0xFF: USB-Address is used for enumeration. 0x01: Real-SN is used for enumeration.

Example for setting enumeration method to USB 2:

1. Start J-Link Commander (JLink.exe) which is part of the J-Link software
2. Enter wconf 0 02 // Set USB-Address 2
3. Enter wconf 1 00 // Set enumeration method to USB-Address
4. Power-cycle J-Link in order to apply new configuration. Re-configuration to REAL-SN enumeration can be done by using the J-Link Configurator, which is part of the J-Link Software and Documentation Package. For further information about the J-Link Configurator and how to use it, please refer to *J-Link Configurator* .

7.8 J-Link control panel

Since software version V3.86 J-Link the J-Link control panel window allows the user to monitor the J-Link status and the target status information in real-time. It also allows the user to configure the use of some J-Link features such as flash download, flash breakpoints and instruction set simulation. The J-Link control panel window can be accessed via the J-Link tray icon in the tray icon list. This icon is available when the debug session is started.



To open the status window, simply click on the tray icon.

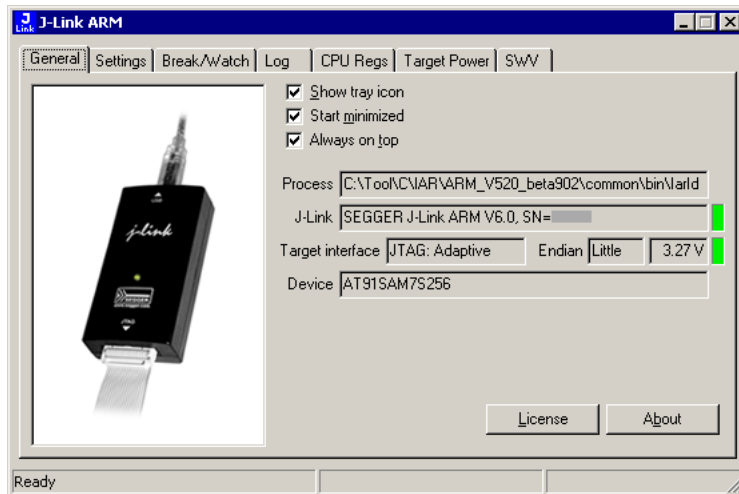

7.8.1 Tabs

The J-Link status window supports different features which are grouped in tabs. The organization of each tab and the functionality which is behind these groups will be explained in this section

7.8.1.1 General

In the General section, general information about J-Link and the target hardware are shown. Moreover the following general settings can be configured:

- Show tray icon: If this checkbox is disabled the tray icon will not show from the next time the DLL is loaded.
- Start minimized: If this checkbox is disabled the J-Link status window will show up automatically each time the DLL is loaded.
- Always on top: If this checkbox is enabled the J-Link status window is always visible even if other windows will be opened.

The general information about target hardware and J-Link which are shown in this section, are:

- Process: Shows the path of the file which loaded the DLL.
- J-Link: Shows OEM of the connected J-Link, the hardware version and the Serial number. If no J-Link is connected it shows "not connected" and the color indicator is red.
- Target interface: Shows the selected target interface (JTAG/SWD) and the current JTAG speed. The target current is also shown. (Only visible if J-Link is connected)
- Endian: Shows the target endianness (Only visible if J-Link is connected)
- Device: Shows the selected device for the current debug session.
- License: Opens the J-Link license manager.
- About: Opens the about dialog.

7.8.1.2 Settings

In the Settings section project- and debug-specific settings can be set. It allows the configuration of the use of flash download and flash breakpoints and some other target specific settings which will be explained in this topic. Settings are saved in the configuration file. This configuration file needs to be set by the debugger. If the debugger does not set it, settings can not be saved. All settings which are modified during the debug session have to be saved by pressing Save settings, otherwise they are lost when the debug session is closed.

Section: Flash download

In this section, settings for the use of the J-Link FlashDL feature and related settings can be configured. When a license for J-Link FlashDL is found, the color indicator is green and "License found" appears right to the J-Link FlashDL usage settings.

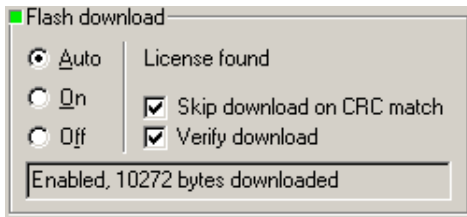

- Auto: This is the default setting of J-Link FlashDL usage. If a license is found J-Link FlashDL is enabled. Otherwise J-Link FlashDL will be disabled internally.
- On: Enables the J-Link FlashDL feature. If no license has been found an error message appears.
- Off: Disables the J-Link FlashDL feature.
- Skip download on CRC match: J-Link checks the CRC of the flash content to determine if the current application has already been downloaded to the flash. If a CRC match occurs, the flash download is not necessary and skipped. (Only available if J-Link FlashDL usage is configured as Auto or On)
- Verify download: If this checkbox is enabled J-Link verifies the flash content after the download. (Only available if J-Link FlashDL usage is configured as Auto or On)

Section: Flash breakpoints:

In this section, settings for the use of the FlashBP feature and related settings can be configured. When a license for FlashBP is found, the color indicator is green and "License found" appears right to the FlashBP usage settings.

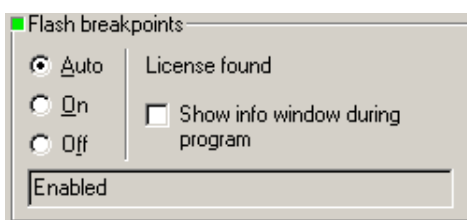

- Auto: This is the default setting of FlashBP usage. If a license has been found the FlashBP feature will be enabled. Otherwise FlashBP will be disabled internally.
- On: Enables the FlashBP feature. If no license has been found an error message appears.
- Off: Disables the FlashBP feature.
- Show window during program : When this checkbox is enabled the "Programming flash" window is shown when flash is re-programmed in order to set/clear flash breakpoints.

Flash download and flash breakpoints independent settings

These settings do not belong to the J-Link flash download and flash breakpoints settings section. They can be configured without any license needed.

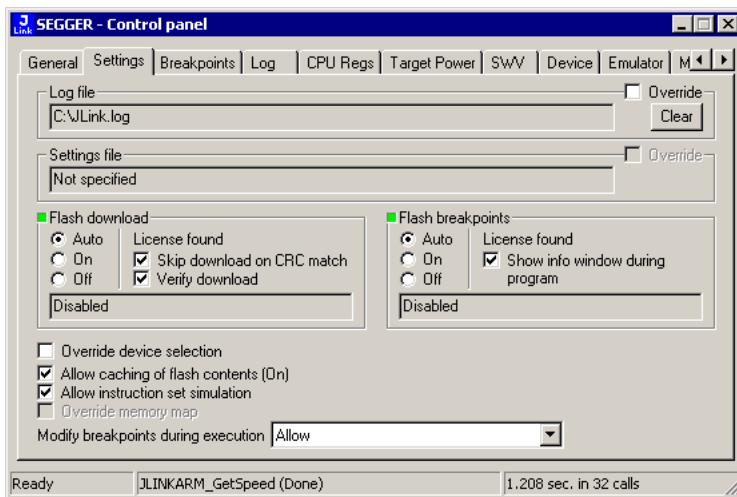

- **Log file:** Shows the path where the J-Link log file is placed. It is possible to override the selection manually by enabling the Override checkbox. If the Override checkbox is enabled a button appears which let the user choose the new location of the log file.
- **Settings file:** Shows the path where the configuration file is placed. This configuration file contains all the settings which can be configured in the Settings tab.
- **Override device selection:** If this checkbox is enabled, a dropdown list appears, which allows the user to set a device manually. This especially makes sense when J-Link can not identify the device name given by the debugger or if a particular device is not yet known to the debugger, but to the J-Link software.
- **Allow caching of flash contents :** If this checkbox is enabled, the flash contents are cached by J-Link to avoid reading data twice. This speeds up the transfer between debugger and target.
- **Allow instruction set simulation:** If this checkbox is enabled, instructions will be simulated as far as possible. This speeds up single stepping, especially when FlashBPs are used.
- **Save settings:** When this button is pushed, the current settings in the Settings tab will be saved in a configuration file. This file is created by J-Link and will be created for each project and each project configuration (e.g. Debug_RAM, Debug_Flash). If no settings file is given, this button is not visible.
- **Modify breakpoints during execution:** This dropdown box allows the user to change the behavior of the DLL when setting breakpoints if the CPU is running. The following options are available:
 - Allow:** Allows settings breakpoints while the CPU is running. If the CPU needs to be halted in order to set the breakpoint, the DLL halts the CPU, sets the breakpoints and restarts the CPU.
 - Allow if CPU does not need to be halted:** Allows setting breakpoints while the CPU is running, if it does not need to be halted in order to set the breakpoint. If the CPU has to be halted the breakpoint is not set.
 - Ask user if CPU needs to be halted:** If the user tries to set a breakpoint while the CPU is running and the CPU needs to be halted in order to set the breakpoint, the user is asked if the breakpoint should be set. If the breakpoint can be set without halting the CPU, the breakpoint is set without explicit confirmation by the user.
 - Do not allow:** It is not allowed to set breakpoints while the CPU is running.

7.8.1.3 Break/Watch

In the Break/Watch section all breakpoints and watchpoints which are in the DLL internal breakpoint and watchpoint list are shown.

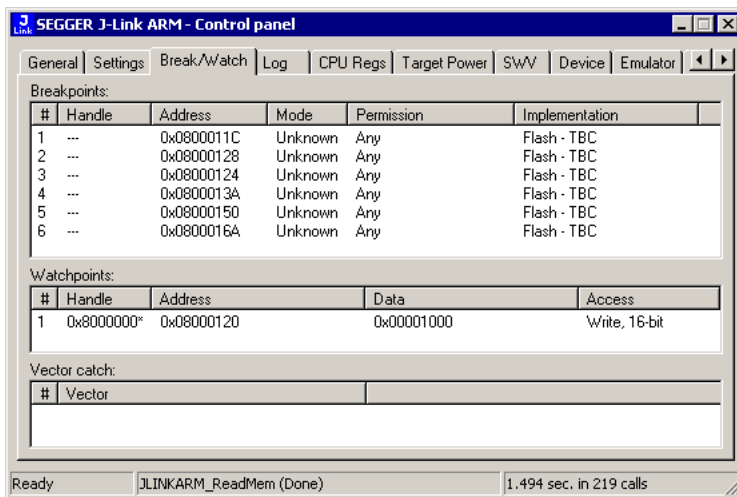

Section: Code

Lists all breakpoints which are in the DLL internal breakpoint list are shown.

- Handle: Shows the handle of the breakpoint.
- Address: Shows the address where the breakpoint is set.
- Mode: Describes the breakpoint type (ARM/THUMB)
- Permission: Describes the breakpoint implementation flags.
- Implementation: Describes the breakpoint implementation type. The breakpoint types are: RAM, Flash, Hard. An additional TBC (to be cleared) or TBS (to be set) gives information about if the breakpoint is (still) written to the target or if it's just in the breakpoint list to be written/cleared.

Note

It is possible for the debugger to bypass the breakpoint functionality of the J-Link software by writing to the debug registers directly. This means for ARM7/ARM9 cores write accesses to the ICE registers, for Cortex-M3 devices write accesses to the memory mapped flash breakpoint registers and in general simple write accesses for software breakpoints (if the program is located in RAM). In these cases, the J-Link software cannot determine the breakpoints set and the list is empty.

Section: Data

In this section, all data breakpoints which are listed in the DLL internal breakpoint list are shown.

- Handle: Shows the handle of the data breakpoint.
- Address: Shows the address where the data breakpoint is set.
- AddrMask: Specifies which bits of Address are disregarded during the comparison for a data breakpoint match. (A 1 in the mask means: disregard this bit)
- Data: Shows on which data to be monitored at the address where the data breakpoint is set.
- Data Mask: Specifies which bits of Data are disregarded during the comparison for a data breakpoint match. (A 1 in the mask means: disregard this bit)
- Ctrl: Specifies the access type of the data breakpoint (read/write).
- CtrlMask: Specifies which bits of Ctrl are disregarded during the comparison for a data breakpoint match.

7.8.1.4 Log

In this section the log output of the DLL is shown. The user can determine which function calls should be shown in the log window. Available function calls to log: Register read/write, Memory read/write, set/clear breakpoint, step, go, halt, is halted.

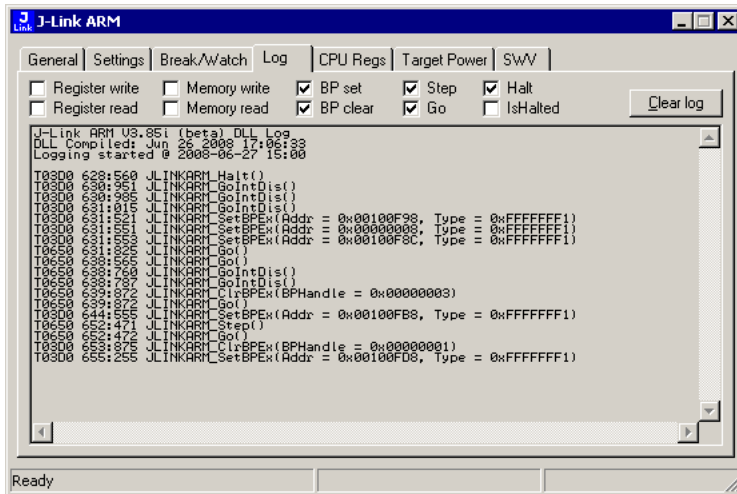

7.8.1.5 CPU Regs

In this section the name and the value of the CPU registers are shown.

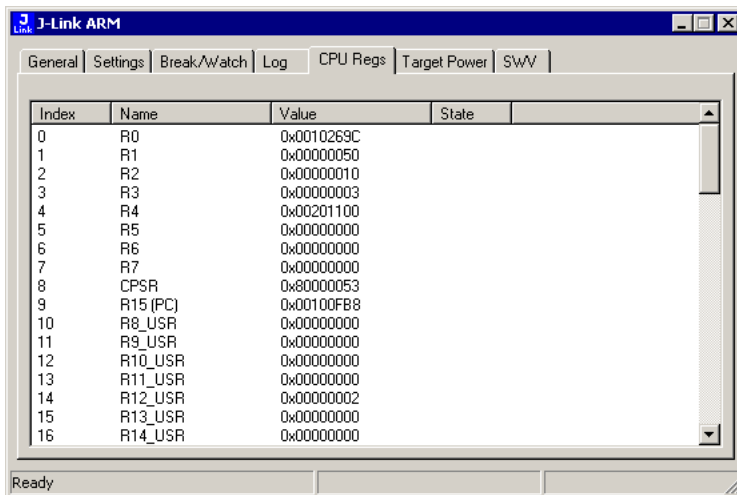

7.8.1.6 Target Power

In this section currently just the power consumption of the target hardware is shown.

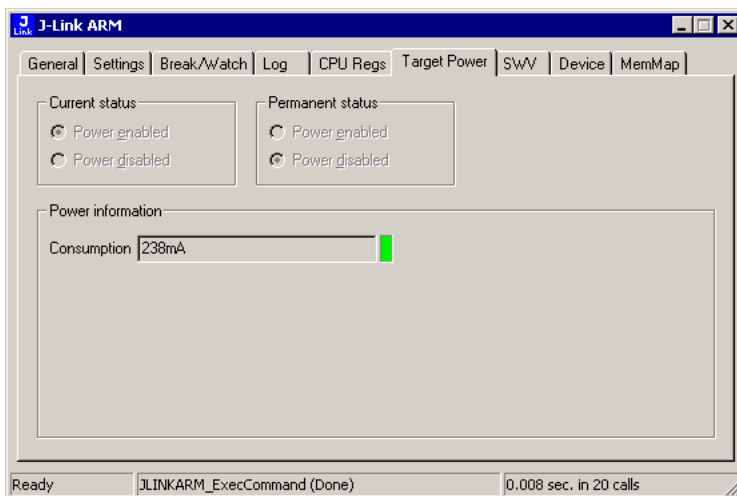

7.8.1.7 SWV

In this section SWV information are shown.

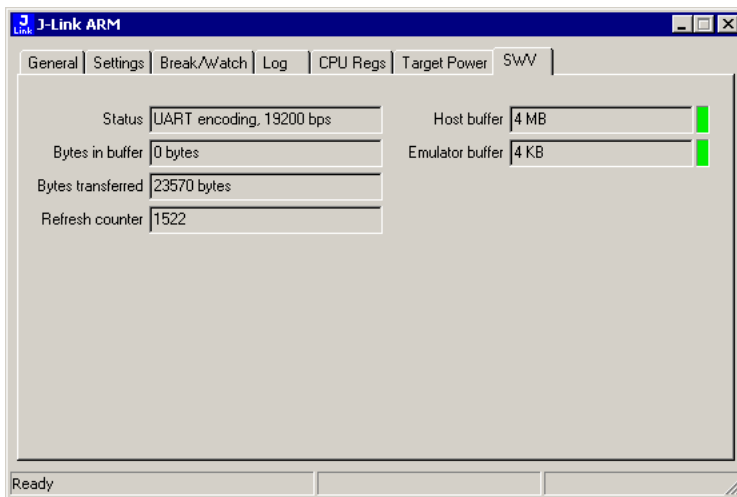

- Status: Shows the encoding and the baudrate of the SWV data received by the target (Manchester/UART, currently J-Link only supports UART encoding).
- Bytes in buffer: Shows how many bytes are in the DLL SWV data buffer.
- Bytes transferred: Shows how many bytes have been transferred via SWV, since the debug session has been started.
- Refresh counter: Shows how often the SWV information in this section has been updated since the debug session has been started.
- Host buffer: Shows the reserved buffer size for SWV data, on the host side.
- Emulator buffer: Shows the reserved buffer size for SWV data, on the emulator side.

7.9 Reset strategies

J-Link / J-Trace supports different reset strategies. This is necessary because there is no single way of resetting and halting a CPU core before it starts to execute instructions. For example reset strategies which use the reset pin can not succeed on targets where the reset pin of the CPU is not connected to the reset pin of the JTAG connector. Reset strategy 0 is always the recommended one because it has been adapted to work on every target even if the reset pin (Pin 15) is not connected.

What is the problem if the core executes some instructions after RESET?

The instructions which are executed can cause various problems. Some cores can be completely "confused", which means they can not be switched into debug mode (CPU can not be halted). In other cases, the CPU may already have initialized some hardware components, causing unexpected interrupts or worse, the hardware may have been initialized with illegal values. In some of these cases, such as illegal PLL settings, the CPU may be operated beyond specification, possibly locking the CPU.

7.9.1 Strategies for ARM 7/9 devices

7.9.1.1 Type 0: Hardware, halt after reset (normal)

The hardware reset pin is used to reset the CPU. After reset release, J-Link continuously tries to halt the CPU. This typically halts the CPU shortly after reset release; the CPU can in most systems execute some instructions before it is halted. The number of instructions executed depends primarily on the JTAG speed: the higher the JTAG speed, the faster the CPU can be halted.

Some CPUs can actually be halted before executing any instruction, because the start of the CPU is delayed after reset release. If a pause has been specified, J-Link waits for the specified time before trying to halt the CPU. This can be useful if a bootloader which resides in flash or ROM needs to be started after reset.

This reset strategy is typically used if nRESET and nTRST are coupled. If nRESET and nTRST are coupled, either on the board or the CPU itself, reset clears the breakpoint, which means that the CPU can not be stopped after reset with the BP@0 reset strategy.

7.9.1.2 Type 1: Hardware, halt with BP@0

The hardware reset pin is used to reset the CPU. Before doing so, the ICE breaker is programmed to halt program execution at address 0; effectively, a breakpoint is set at address 0. If this strategy works, the CPU is actually halted before executing a single instruction. This reset strategy does not work on all systems for two reasons:

- If nRESET and nTRST are coupled, either on the board or the CPU itself, reset clears the breakpoint, which means the CPU is not stopped after reset.
- Some MCUs contain a bootloader program (sometimes called kernel), which needs to be executed to enable JTAG access.

7.9.1.3 Type 2: Software, for Analog Devices ADuC7xxx MCUs

This reset strategy is a software strategy. The CPU is halted and performs a sequence which causes a peripheral reset. The following sequence is executed:

- The CPU is halted.
- A software reset sequence is downloaded to RAM.
- A breakpoint at address 0 is set.
- The software reset sequence is executed.

This sequence performs a reset of CPU and peripherals and halts the CPU before executing instructions of the user program. It is the recommended reset sequence for Analog Devices ADuC7xxx MCUs and works with these chips only.

7.9.1.4 Type 3: No reset

No reset is performed. Nothing happens.

7.9.1.5 Type 4: Hardware, halt with WP

The hardware RESET pin is used to reset the CPU. After reset release, J-Link continuously tries to halt the CPU using a watchpoint. This typically halts the CPU shortly after reset release; the CPU can in most systems execute some instructions before it is halted.

The number of instructions executed depends primarily on the JTAG speed: the higher the JTAG speed, the faster the CPU can be halted. Some CPUs can actually be halted before executing any instruction, because the start of the CPU is delayed after reset release.

7.9.1.6 Type 5: Hardware, halt with DBGRQ

The hardware RESET pin is used to reset the CPU. After reset release, J-Link continuously tries to halt the CPU using the DBGRQ. This typically halts the CPU shortly after reset release; the CPU can in most systems execute some instructions before it is halted.

The number of instructions executed depends primarily on the JTAG speed: the higher the JTAG speed, the faster the CPU can be halted. Some CPUs can actually be halted before executing any instruction, because the start of the CPU is delayed after reset release.

7.9.1.7 Type 6: Software

This reset strategy is only a software reset. "Software reset" means basically no reset, just changing the CPU registers such as PC and CPSR. This reset strategy sets the CPU registers to their after-Reset values:

- PC = 0
- CPSR = 0xD3 (Supervisor mode, ARM, IRQ / FIQ disabled)
- All SPSR registers = 0x10
- All other registers (which are unpredictable after reset) are set to 0.
- The hardware RESET pin is not affected.

7.9.1.8 Type 7: Reserved

Reserved reset type.

7.9.1.9 Type 8: Software, for ATMEL AT91SAM7 MCUs

The reset pin of the device is disabled by default. This means that the reset strategies which rely on the reset pin (low pulse on reset) do not work by default. For this reason a special reset strategy has been made available.

It is recommended to use this reset strategy. This special reset strategy resets the peripherals by writing to the RSTC_CR register. Resetting the peripherals puts all peripherals in the defined reset state. This includes memory mapping register, which means that after reset flash is mapped to address 0. It is also possible to achieve the same effect by writing 0x4 to the RSTC_CR register located at address 0xfffffd00.

7.9.1.10 Type 9: Hardware, for NXP LPC MCUs

After reset a bootloader is mapped at address 0 on ARM 7 LPC devices. This reset strategy performs a reset via reset strategy Type 1 in order to reset the CPU. It also ensures that flash is mapped to address 0 by writing the MEMMAP register of the LPC. This reset strategy is the recommended one for all ARM 7 LPC devices.

7.9.2 Strategies for Cortex-M devices

J-Link supports different specific reset strategies for the Cortex-M cores. All of the following reset strategies are available in JTAG and in SWD mode. All of them halt the CPU after the reset.

Note

It is recommended that the correct device is selected in the debugger so the debugger can pass the device name to the J-Link DLL which makes it possible for J-Link to detect what is the best reset strategy for the device. Moreover, we recommend that the debugger uses reset type 0 to allow J-Link to dynamically select what reset is the best for the connected device.

7.9.2.1 Type 0: Normal

This is the default strategy. It does whatever is the best way to reset the target device. If the correct device is selected in the debugger this reset strategy may also perform some special handling which might be necessary for the connected device. This for example is the case for devices which have a ROM bootloader that needs to run after reset and before the user application is started (especially if the debug interface is disabled after reset and needs to be enabled by the ROM bootloader).

For most devices, this reset strategy does the same as reset strategy 8 does:

1. Make sure that the device halts immediately after reset (before it can execute any instruction of the user application) by setting the VC_CORERESET in the DEMCR .
2. Reset the core and peripherals by setting the SYSRESETREQ bit in the AIRCR .
3. Wait for the S_RESET_ST bit in the DHCSR to first become high (reset active) and then low (reset no longer active) afterwards.
4. Clear VC_CORERESET.

7.9.2.2 Type 1: Core

Only the core is reset via the VECTRESET bit. The peripherals are not affected. After setting the VECTRESET bit, J-Link waits for the S_RESET_ST bit in the Debug Halting Control and Status Register (DHCSR) to first become high and then low afterwards. The CPU does not start execution of the program because J-Link sets the VC_CORERESET bit before reset, which causes the CPU to halt before execution of the first instruction.

Note

In most cases it is not recommended to reset the core only since most target applications rely of the reset state of some peripherals (PLL, External memory interface etc.) and may be confused if they boot up but the peripherals are already configured.

7.9.2.3 Type 2: ResetPin

J-Link pulls its RESET pin low to reset the core and the peripherals. This normally causes the CPU RESET pin of the target device to go low as well, resulting in a reset of both CPU and peripherals. This reset strategy will fail if the RESET pin of the target device is not pulled low. The CPU does not start execution of the program because J-Link sets the VC_CORERESET bit before reset, which causes the CPU to halt before execution of the first instruction.

7.9.2.4 Type 3: Connect under Reset

J-Link connects to the target while keeping Reset active (reset is pulled low and remains low while connecting to the target). This is the recommended reset strategy for STM32 devices. This reset strategy has been designed for the case that communication with the core is not possible in normal mode so the VC_CORERESET bit can not be set in order to guarantee that the core is halted immediately after reset.

7.9.2.5 Type 4: Reset core & peripherals, halt after bootloader

Same as type 0, but bootloader is always executed. This reset strategy has been designed for MCUs/CPUs which have a bootloader located in ROM which needs to run at first, after

reset (since it might initialize some target settings to their reset state). When using this reset strategy, J-Link will let the bootloader run after reset and halts the target immediately after the bootloader and before the target application is started. This is the recommended reset strategy for LPC11xx and LPC13xx devices where a bootloader should execute after reset to put the chip into the “real” reset state.

7.9.2.6 Type 5: Reset core & peripherals, halt before bootloader

Basically the same as reset type 8. Performs a reset of core & peripherals and halts the CPU immediately after reset. The ROM bootloader is NOT executed.

7.9.2.7 Type 6: Reset for Freescale Kinetis devices

Performs a via reset strategy 0 (normal) first in order to reset the core & peripherals and halt the CPU immediately after reset. After the CPU is halted, the watchdog is disabled, since the watchdog is running after reset by default. If the target application does not feed the watchdog, J-Link loses connection to the device since it is reset permanently.

7.9.2.8 Type 7: Reset for Analog Devices CPUs (ADI Halt after kernel)

Performs a reset of the core and peripherals by setting the SYSRESETREQ bit in the AIRCR. The core is allowed to perform the ADI kernel (which enables the debug interface) but the core is halted before the first instruction after the kernel is executed in order to guarantee that no user application code is performed after reset.

7.9.2.9 Type 8: Reset core and peripherals

J-Link tries to reset both, core and peripherals by setting the SYSRESETREQ bit in the AIRCR. VC_CORERESET in the DEMCR is also set to make sure that the CPU is halted immediately after reset and before executing any instruction.

Reset procedure:

1. Make sure that the device halts immediately after reset (before it can execute any instruction of the user application) by setting the VC_CORERESET in the DEMCR .
2. Reset the core and peripherals by setting the SYSRESETREQ bit in the AIRCR .
3. Wait for the S_RESET_ST bit in the DHCSR to first become high (reset active) and then low (reset no longer active) afterwards.
4. Clear VC_CORERESET. This type of reset may fail if:
 - J-Link has no connection to the debug interface of the CPU because it is in a low power mode.
 - The debug interface is disabled after reset and needs to be enabled by a device internal bootloader. This would cause J-Link to lose communication after reset since the CPU is halted before it can execute the internal bootlader.

7.9.2.10 Type 9: Reset for LPC1200 devices

On the NXP LPC1200 devices the watchdog is enabled after reset and not disabled by the bootloader, if a valid application is in the flash memory. Moreover, the watchdog keeps counting if the CPU is in debug mode. When using this reset strategy, J-Link performs a reset of the CPU and peripherals, using the SYSRESETREQ bit in the AIRCR and halts the CPU after the bootloader has been performed and before the first instruction of the user code is executed. Then the watchdog of the LPC1200 device is disabled. This reset strategy is only guaranteed to work on “modern” J-Links (J-Link V8, J-Link Pro, J-link ULTRA, J-Trace for Cortex-M, J-Link Lite) and if a SWD speed of min. 1 MHz is used. This reset strategy should also work for J-Links with hardware version 6, but it can not be guaranteed that these J-Links are always fast enough in disabling the watchdog.

7.9.2.11 Type 10: Reset for Samsung S3FN60D devices

On the Samsung S3FN60D devices the watchdog may be running after reset (if the watchdog is active after reset or not depends on content of the smart option bytes at addr 0xC0). The watchdog keeps counting even if the CPU is in debug mode (e.g. halted by a halt re-

quest or halted by vector catch). When using this reset strategy, J-Link performs a reset of the CPU and peripherals, using the SYSRESETREQ bit and sets VC_CORERESET in order to halt the CPU after reset, before it executes a single instruction. Then the watchdog of the S3FN60D device is disabled.

7.10 Using DCC for memory access

The ARM7/9 architecture requires cooperation of the CPU to access memory when the CPU is running (not in debug mode). This means that memory cannot normally be accessed while the CPU is executing the application program. The normal way to read or write memory is to halt the CPU (put it into debug mode) before accessing memory. Even if the CPU is restarted after the memory access, the real time behavior is significantly affected; halting and restarting the CPU costs typically multiple milliseconds. For this reason, most debuggers do not even allow memory access if the CPU is running.

However, there is one other option: DCC (Direct communication channel) can be used to communicate with the CPU while it is executing the application program. All that is required is the application program to call a DCC handler from time to time. This DCC handler typically requires less than 1 s per call.

The DCC handler, as well as the optional DCC abort handler, is part of the J-Link software package and can be found in the Samples\DCC\IAR directory of the package.

7.10.1 What is required?

- An application program on the host (typically a debugger) that uses DCC.
- A target application program that regularly calls the DCC handler.
- The supplied abort handler should be installed (optional).

An application program that uses DCC is JLink.exe .

7.10.2 Target DCC handler

The target DCC handler is a simple C-file taking care of the communication. The function `DCC_Process()` needs to be called regularly from the application program or from an interrupt handler. If an RTOS is used, a good place to call the DCC handler is from the timer tick interrupt. In general, the more often the DCC handler is called, the faster memory can be accessed. On most devices, it is also possible to let the DCC generate an interrupt which can be used to call the DCC handler.

7.10.3 Target DCC abort handler

An optional DCC abort handler (a simple assembly file) can be included in the application. The DCC abort handler allows data aborts caused by memory reads/writes via DCC to be handled gracefully. If the data abort has been caused by the DCC communication, it returns to the instruction right after the one causing the abort, allowing the application program to continue to run. In addition to that, it allows the host to detect if a data abort occurred.

In order to use the DCC abort handler, 3 things need to be done:

- Place a branch to `DCC_Abort` at address `0x10` ("vector" used for data aborts).
- Initialize the Abort-mode stack pointer to an area of at least 8 bytes of stack memory required by the handler.
- Add the DCC abort handler assembly file to the application.

7.11 The J-Link settings file

Most IDEs provide a path to a J-Link settings file on a per-project-per-debug-configuration basis. This file is used by J-Link to store various debug settings that shall survive between debug sessions of a project. It also allows the user to perform some override of various settings. If a specific behavior / setting can be overridden via the settings file, is explained in the specific sections that describe the behavior / setting. Since the location and name of the settings file is different for various IDEs, in the following the location and naming convention of the J-Link settings file for various IDEs is explained.

7.11.1 SEGGER Embedded Studio

Settings file with default settings is created on first start of a debug session. There is one settings file per build configuration for the project.

Naming is: `_<ProjectName>_<DebugConfigName>.jlink`

The settings file is created in the same directory where the project file (*.emProject) is located.

Example: The SES project is called "MyProject" and has two configurations "Debug" and "Release". For each of the configurations, a settings file will be created at the first start of the debug session:

`_MyProject_Debug.jlink` `_MyProject_Release.jlink`

7.11.2 Keil MDK-ARM (uVision)

Settings file with default settings is created on first start of a debug session. There is one settings file per project.

Naming is: `JLinksettings.ini`

The settings file is created in the same directory where the project file (*.uvprojx) is located.

7.11.3 IAR EWARM

Settings file with default settings is created on first start of a debug session. There is one settings file per build configuration for the project.

Naming is: `<ProjectName>_<DebugConfig>.jlink`

The settings file is created in a "settings" subdirectory where the project file is located.

7.11.4 Mentor Sourcery CodeBench for ARM

CodeBench does not directly specify a J-Link settings file but allows the user to specify a path to one in the project settings under Debugger -> Settings File . We recommend to copy the J-Link settings file template from `$JLINK_INST_DIR\Samples\JLink\Settings-Files\Sample.jlinksettings` to the directory where the CodeBench project is located, once when creating a new project. Then select this file in the project options.

7.12 J-Link script files

In some situations it is necessary to customize some actions performed by J-Link. In most cases it is the connection sequence and/or the way in which a reset is performed by J-Link, since some custom hardware needs some special handling which cannot be integrated into the generic part of the J-Link software. J-Link script files are written in C-like syntax in order to have an easy start to learning how to write J-Link script files. The script file syntax supports most statements (if-else, while, declaration of variables, ...) which are allowed in C, but not all of them. Moreover, there are some statements that are script file specific. The script file allows maximum flexibility, so almost any target initialization which is necessary can be supported.

7.12.1 Actions that can be customized

The script file support allows customizing of different actions performed by J-Link. Depending on whether the corresponding function is present in the script file or not, a generically implemented action is replaced by an action defined in a script file. In the following all J-Link actions which can be customized using a script file are listed and explained.

Action	Prototype
<code>ConfigTargetSettings()</code>	<code>int ConfigTargetSettings (void);</code>
<code>InitTarget()</code>	<code>int InitTarget (void);</code>
<code>SetupTarget()</code>	<code>int SetupTarget (void);</code>
<code>ResetTarget()</code>	<code>int ResetTarget (void);</code>
<code>InitEmu()</code>	<code>int InitEMU (void);</code>
<code>OnTraceStop()</code>	<code>int OnTraceStop (void);</code>
<code>OnTraceStart()</code>	<code>int OnTraceStart (void);</code>
<code>AfterResetTarget()</code>	<code>int AfterResetTarget (void);</code>
<code>SWO_EnableTarget()</code>	<code>int SWO_EnableTarget (void);</code>
<code>SWO_GetSWOBaseClock()</code>	<code>U32 SWO_GetSWOBaseClock (U32 CPUclock);</code>
<code>HandleBeforeFlashProg()</code>	<code>int HandleBeforeFlashProg (void);</code>
<code>HandleAfterFlashProg()</code>	<code>int HandleAfterFlashProg (void);</code>
<code>StartETM()</code>	<code>int StartETM (void);</code>
<code>StopETM()</code>	<code>int StopETM (void);</code>
<code>StartTPIU()</code>	<code>int StartTPIU (void);</code>
<code>StopTPIU()</code>	<code>int StopTPIU (void);</code>
<code>StartTMC()</code>	<code>int StartTMC (void);</code>
<code>StopTMC()</code>	<code>int StopTMC (void);</code>
<code>StartPTM()</code>	<code>int StartPTM (void);</code>
<code>StopPTM()</code>	<code>int StopPTM (void);</code>
<code>StartTF()</code>	<code>int StartTF (void);</code>
<code>StopTF()</code>	<code>int StopTF (void);</code>
<code>StartETB()</code>	<code>int StartETB (void);</code>
<code>StopETB()</code>	<code>int StopETB (void);</code>

7.12.1.1 ConfigTargetSettings()

Called before `InitTarget()`. Mainly used to set some global DLL variables to customize the normal connect procedure. For ARM CoreSight devices this may be specifying the base address of some CoreSight components (ETM, ...) that cannot be auto-detected by J-Link

due to erroneous ROM tables etc. May also be used to specify the device name in case debugger does not pass it to the DLL.

Prototype

```
int ConfigTargetSettings(void);
```

Notes / Limitations

- May not, under absolutely NO circumstances, call any API functions that perform target communication.
- Should only set some global DLL variables

7.12.1.2 InitTarget()

Replaces the target-CPU-auto-find procedure of the J-Link DLL. Useful for target CPUs that are not accessible by default and need some special steps to be executed before the normal debug probe connect procedure can be executed successfully. Example devices are MCUs from TI which have a so-called ICEPick JTAG unit on them that needs to be configured via JTAG, before the actual CPU core is accessible via JTAG.

Prototype

```
int InitTarget(void);
```

Notes / Limitations

- If target interface JTAG is used: JTAG chain has to be specified manually before leaving this function (meaning all devices and their TAP IDs have to be specified by the user). Also appropriate JTAG TAP number to communicate with during the debug session has to be manually specified in this function.
- MUST NOT use any MEM_ API functions
- Global DLL variable "CPU" MUST be set when implementing this function, so the DLL knows which CPU module to use internally.

7.12.1.3 SetupTarget()

If present, called after InitTarget() and after general debug connect sequence has been performed by J-Link. Usually used for more high-level CPU debug setup like writing certain memory locations, initializing PLL for faster download etc.

Prototype

```
int SetupTarget(void);
```

Notes / Limitations

- Does not replace any DLL functionality but extends it.
- May use MEM_ API functions

7.12.1.4 ResetTarget()

Replaces reset strategies of DLL. No matter what reset type is selected in the DLL, if this function is present, it will be called instead of the DLL internal reset.

Prototype

```
int ResetTarget(void);
```

Notes / Limitations

- DLL expects target CPU to be halted / in debug mode, when leaving this function
- May use MEM_ API functions

7.12.1.5 InitEMU()

This function can be used to initialize the emulator settings like for example the host interface (e.g. in case of it cannot be selected in the IDE). This function should be used thoughtful and only if you know exactly what you are doing as there are many things which needs to be taken into account. Currently this function is only used to override the host interface (USB or IP). It will be called right before the connection to the emulator is opened.

Allowed J-Link Command Strings

- [SetHostIF](#)

Prototype

```
int InitEMU(void);
```

7.12.1.6 OnTraceStop()

Called right before capturing of trace data is stopped on the J-Link / J-Trace. On some target, an explicit flush of the trace FIFOs is necessary to get the latest trace data. If such a flush is not performed, the latest trace data may not be output by the target

Prototype

```
int OnTraceStop(void);
```

Notes / Limitations

- May use MEM_ functions

7.12.1.7 OnTraceStart()

If present, called right before trace is started. Used to initialize MCU specific trace related things like configuring the trace pins for alternate function.

Prototype

```
int OnTraceStart(void);
```

Return value	Meaning
# 0	O.K.
< 0	Error

Notes / Limitations

- May use high-level API functions like JLINK_MEM_ etc.
- Should not call JLINK_TARGET_Halt(). Can rely on target being halted when entering this function.

7.12.1.8 AfterResetTarget()

If present, called after ResetTarget(). Usually used to initialize peripherals which have been reset during reset, disable watchdogs which may be active after reset, etc... Apart from this, for some cores it is necessary to perform some special operations after reset to guarantee proper device functionality after reset. This is mainly the case on devices which have some bugs that occur at the time of a system reset (not power on reset).

Prototype

```
int AfterResetTarget(void);
```

Notes / Limitations

- DLL expects target CPU to be halted / in debug mode, when leaving this function
- May use MEM_ API functions

7.12.1.9 SWO_EnableTarget()

If present, called before SWO_GetSWOBaseClock(). Used for target device that need additional init steps to enable SWO. For example if there are none CoreSight registers that need to be enabled or more than one pin can be configured to be the SWO pin.

Prototype

```
int SWO_EnableTarget(void);
```

Notes / Limitations

- This function should only be called if the target device needs extra initialization of SWO registers that are not generic.

7.12.1.10 SWO_GetSWOBaseClock()

Determines the actual SWO base clock that is supplied by the device to the SWO CoreSight logic. On most devices it is CPUClock / 1 but there are exceptions for which this function can be used for.

Prototype

```
U32 SWO_GetSWOBaseClock(U32 CPUClock);
```

Parameter	Description
CPUClock	Measured CPU clock speed in Hz

<ReturnValue>

The return value is the actual SWO base clock speed.

Notes / Limitations

- This function should only be called if the target device has some other SWO base clock than CPUClock / 1.

7.12.1.11 HandleBeforeFlashProg()

If present, called right before flash programming is performed Usually used to initialize peripherals which are used during the flash download like for example clocks or port pins (e.g. QSPI alternate function)

Prototype

```
int HandleBeforeFlashProg(void);
```

Notes / Limitations

- DLL expects target CPU to be halted / in debug mode, when leaving this function
- May use MEM_ API functions

7.12.1.12 HandleAfterFlashProg()

If present, called right after flash programming Usually used to restore initialized peripherals which have been used during the flash download like for example clocks or port pins (e.g. QSPI alternate function)

Prototype

```
int HandleAfterFlashProg(void);
```

Notes / Limitations

- DLL expects target CPU to be halted / in debug mode, when leaving this function
- May use MEM_ API functions

7.12.1.13 StartETM()

If present, replaces generic initialization of Embedded Trace Macrocell (ETM) trace settings. Used for target devices that need different init steps for ETM which are not set automatically by J-Link/J-Trace.

Prototype

```
int StartETM(void);
```

Notes / Limitations

- Only to be used if you are familiar with trace initializations. If the generic initialization from J-Link software produces a trace output, do not use this function!
- May use high-level API functions like JLINK_MEM_ etc.
- Should not call JLINK_TARGET_Halt(). Can rely on target being halted when entering this function.

7.12.1.14 StopETM()

If present, replaces generic deinitialization of Embedded Trace Macrocell (ETM) trace settings. Used for target devices that need different deinit steps for ETM which are not set automatically by J-Link/J-Trace.

Prototype

```
int StopETM(void);
```

Notes / Limitations

- Only to be used if you are familiar with trace initializations. If the generic initialization from J-Link software produces a trace output, do not use this function!
- May use high-level API functions like JLINK_MEM_ etc.
- Should not call JLINK_TARGET_Halt(). Can rely on target being halted when entering this function.

7.12.1.15 StartETB()

If present, replaces generic initialization of Embedded Trace Buffer (ETB) trace settings. Used for target devices that need different init steps for ETB which are not set automatically by J-Link/J-Trace.

Prototype

```
int StartETB(void);
```

Notes / Limitations

- Only to be used if you are familiar with trace initializations. If the generic initialization from J-Link software produces a trace output, do not use this function!
- May use high-level API functions like JLINK_MEM_ etc.
- Should not call JLINK_TARGET_Halt(). Can rely on target being halted when entering this function.

7.12.1.16 StopETB()

If present, replaces generic deinitialization of Embedded Trace Buffer (ETB) trace settings. Used for target devices that need different deinit steps for ETB which are not set automatically by J-Link/J-Trace.

Prototype

```
int StopETB(void);
```

Notes / Limitations

- Only to be used if you are familiar with trace initializations. If the generic initialization from J-Link software produces a trace output, do not use this function!
- May use high-level API functions like `JLINK_MEM_` etc.
- Should not call `JLINK_TARGET_Halt()`. Can rely on target being halted when entering this function.

7.12.1.17 StartTPIU()

If present, replaces generic initialization of Trace Port Interface Unit (TPIU) trace settings. Used for target devices that need different init steps for TPIU which are not set automatically by J-Link/J-Trace.

Prototype

```
int StartTPIU(void);
```

Notes / Limitations

- Only to be used if you are familiar with trace initializations. If the generic initialization from J-Link software produces a trace output, do not use this function!
- May use high-level API functions like `JLINK_MEM_` etc.
- Should not call `JLINK_TARGET_Halt()`. Can rely on target being halted when entering this function.

7.12.1.18 StopTPIU()

If present, replaces generic deinitialization of Trace Port Interface Unit (TPIU) trace settings. Used for target devices that need different deinit steps for TPIU which are not set automatically by J-Link/J-Trace.

Prototype

```
int StopTPIU(void);
```

Notes / Limitations

- Only to be used if you are familiar with trace initializations. If the generic initialization from J-Link software produces a trace output, do not use this function!
- May use high-level API functions like `JLINK_MEM_` etc.
- Should not call `JLINK_TARGET_Halt()`. Can rely on target being halted when entering this function.

7.12.1.19 StartTMC()

If present, replaces generic initialization of Trace Memory Controller (TMC) trace settings. Used for target devices that need different init steps for TMC which are not set automatically by J-Link/J-Trace.

Prototype

```
int StartTMC(void);
```

Notes / Limitations

- Only to be used if you are familiar with trace initializations. If the generic initialization from J-Link software produces a trace output, do not use this function!
- May use high-level API functions like `JLINK_MEM_` etc.
- Should not call `JLINK_TARGET_Halt()`. Can rely on target being halted when entering this function.

7.12.1.20 StopTMC()

If present, replaces generic deinitialization of Trace Memory Controller (TMC) trace settings. Used for target devices that need different deinit steps for TMC which are not set automatically by J-Link/J-Trace.

Prototype

```
int StopTMC(void);
```

Notes / Limitations

- Only to be used if you are familiar with trace initializations. If the generic initialization from J-Link software produces a trace output, do not use this function!
- May use high-level API functions like JLINK_MEM_ etc.
- Should not call JLINK_TARGET_Halt(). Can rely on target being halted when entering this function.

7.12.1.21 StartTF()

If present, replaces generic initialization of Trace Funnel (TF) trace settings. Used for target devices that need different init steps for TF which are not set automatically by J-Link/J-Trace.

Prototype

```
int StartTF(void);
```

Notes / Limitations

- Only to be used if you are familiar with trace initializations. If the generic initialization from J-Link software produces a trace output, do not use this function!
- May use high-level API functions like JLINK_MEM_ etc.
- Should not call JLINK_TARGET_Halt(). Can rely on target being halted when entering this function.

7.12.1.22 StopTF()

If present, replaces generic deinitialization of Trace Funnel (TF) trace settings. Used for target devices that need different deinit steps for TF which are not set automatically by J-Link/J-Trace.

Prototype

```
int StopTF(void);
```

Notes / Limitations

- Only to be used if you are familiar with trace initializations. If the generic initialization from J-Link software produces a trace output, do not use this function!
- May use high-level API functions like JLINK_MEM_ etc.
- Should not call JLINK_TARGET_Halt(). Can rely on target being halted when entering this function.

7.12.1.23 StartPTM()

If present, replaces generic initialization of Program Flow Trace (PTM) trace settings. Used for target devices that need different init steps for PTM which are not set automatically by J-Link/J-Trace.

Prototype

```
int StartPTM(void);
```

Notes / Limitations

- Only to be used if you are familiar with trace initializations. If the generic initialization from J-Link software produces a trace output, do not use this function!
- May use high-level API functions like `JLINK_MEM_` etc.
- Should not call `JLINK_TARGET_Halt()`. Can rely on target being halted when entering this function.

7.12.1.24 StopPTM()

If present, replaces generic initialization of Program Flow Trace (PTM) trace settings. Used for target devices that need different init steps for PTM which are not set automatically by J-Link/J-Trace.

Prototype

```
int StopPTM(void);
```

Notes / Limitations

- Only to be used if you are familiar with trace initializations. If the generic initialization from J-Link software produces a trace output, do not use this function!
- May use high-level API functions like `JLINK_MEM_` etc.
- Should not call `JLINK_TARGET_Halt()`. Can rely on target being halted when entering this function.

7.12.2 Script file API functions

In the following, the API functions which can be used in a script file to communicate with the DLL are explained.

Returns	Function	Parameters
int	<code>JLINK_C2_ReadAddr()</code>	(U32* pAddr);
int	<code>JLINK_C2_WriteAddr()</code>	(U32 Addr);
int	<code>JLINK_C2_ReadData()</code>	(U8* pData, int NumItems);
int	<code>JLINK_C2_WriteData()</code>	(const U8* pData, int NumItems);
int	<code>JLINK_CORESIGHT_AddAP()</code>	(int Index, U32 Type);
int	<code>JLINK_CORESIGHT_Configure()</code>	(const char* sConfig);
int	<code>JLINK_CORESIGHT_ReadAP()</code>	(int RegIndex);
int	<code>JLINK_CORESIGHT_ReadDP()</code>	(int RegIndex);
int	<code>JLINK_CORESIGHT_ReadDAP()</code>	(int RegIndex, int APnDP, U32* Data);
int	<code>JLINK_CORESIGHT_WriteAP()</code>	(int RegIndex, U32 Data);
int	<code>JLINK_CORESIGHT_WriteDP()</code>	(int RegIndex, U32 Data);
int	<code>JLINK_CORESIGHT_WriteDAP()</code>	(int RegIndex, int APnDP, U32 Data);
int	<code>JLINK_ExecCommand()</code>	(const char* sMsg);
int	<code>JLINK_GetTime()</code>	(void);
int	<code>JLINK_GetPinState()</code>	(U8 iPin);
int	<code>JLINK_JTAG_GetDeviceId()</code>	(int DeviceIndex);
int	<code>JLINK_JTAG_GetU32()</code>	(int BitPos);
int	<code>JLINK_JTAG_ReadWriteBits()</code>	(const U8 * pTDI, U8 * pTMS, U8 * pTDO, unsigned NumBits);
int	<code>JLINK_JTAG_Reset()</code>	(void);
int	<code>JLINK_JTAG_SetDeviceId()</code>	(int DeviceIndex, U32 Id);
int	<code>JLINK_JTAG_StartDR()</code>	(void);

Returns	Function	Parameters
int	JLINK_JTAG_Store()	(U32 tms, U32 tdi, U32 NumBits);
int	JLINK_JTAG_StoreClocks()	(int NumClocks);
int	JLINK_JTAG_StoreDR()	(U32 tdi, int NumBits);
int	JLINK_JTAG_StoreIR()	(U32 Cmd);
int	JLINK_JTAG_Write()	(U32 tms, U32 tdi, U32 NumBits);
int	JLINK_JTAG_WriteClocks()	(int NumClocks);
int	JLINK_JTAG_WriteDR()	(U32 tdi, int NumBits);
int	JLINK_JTAG_WriteDRCont()	(U32 Data, int NumBits);
int	JLINK_JTAG_WriteDREnd()	(U32 Data, int NumBits);
int	JLINK_JTAG_WriteIR()	(U32 Cmd);
int	JLINK_PIN_Override()	(const U32* paMode, U32* paState);
int	JLINK_MemRegion()	(const char* sConfig);
int	JLINK_MEM_WriteU8()	(U32 Addr, U32 Data);
int	JLINK_MEM_WriteU16()	(U32 Addr, U32 Data);
int	JLINK_MEM_WriteU32()	(U32 Addr, U32 Data);
U8	JLINK_MEM_ReadU8()	(U32 Addr);
U16	JLINK_MEM_ReadU16()	(U32 Addr);
U32	JLINK_MEM_ReadU32()	(U32 Addr);
int	JLINK_MEM_Preserve()	(U32 Addr, U32 NumBytes);
int	JLINK_MEM_Restore()	(int Handle);
int	JLINK_MEM_Fill()	(U32 Addr, U32 NumBytes, U32 FillVal);
void	JLINK_SelectTIF()	(U32 tif);
int	JLINK_SetDevice()	(const char* sDevice);
int	JLINK_SWD_ReadWriteBits()	(const U8* pDataIn, const U8* pDirection, U8* pDataOut, int NumBits);
int	JLINK_SYS_MessageBox()	(const char* sMsg);
int	JLINK_SYS_MessageBox1()	(const char* sMsg, int v);
int	JLINK_SYS_Report()	(const char* sMsg);
int	JLINK_SYS_Report1()	(const char* sMsg, int v);
int	JLINK_SYS_Sleep()	(int Delayms);
int	JLINK_SYS_UnsecureDialog()	(const char* sText, const char* sQuestion, const char* sIdent, int DefaultAnswer, U32 Flags);
int	JLINK_TARGET_IsHalted()	(void);
int	JLINK_TARGET_Halt()	(void);
void	JLINK_TIF_ActivateTargetReset()	(void);
void	JLINK_TIF_ReleaseTargetReset()	(void);
void	JLINK_TIF_SetClrTCK()	(int OnOff);
void	JLINK_TIF_SetClrTMS()	(int OnOff);
void	JLINK_TIF_SetClrTDI()	(int OnOff);
void	JLINK_TIF_SetSpeed()	(U32 Speed);

7.12.2.1 JLINK_C2_ReadAddr()

Reads the address register of the C2 interface.

Prototype

```
int JLINK_C2_ReadAddr(U32* pAddr);
```

Return Value

Return value	Description
≥ 0	O.K.
< 0	Error

7.12.2.2 JLINK_C2_WriteAddr()

Writes the address register of the C2 interface.

Prototype

```
int JLINK_C2_WriteAddr(U32 Addr);
```

Return Value

Return value	Description
≥ 0	O.K.
< 0	Error

7.12.2.3 JLINK_C2_ReadData()

Reads the data register of the C2 interface.

Prototype

```
int JLINK_C2_ReadData(U8* pData, int NumItems);
```

Parameter	Description
pData	Pointer to buffer to read to
NumItems	NumBytes to read

Return Value

Return value	Description
≥ 0	O.K.
< 0	Error

7.12.2.4 JLINK_C2_WriteData()

Writes the data register of the C2 interface.

Prototype

```
int JLINK_C2_WriteData(const U8* pData, int NumItems);
```

Parameter	Description
pData	Pointer to data to write
NumItems	NumBytes to write

Return Value

Return value	Description
≥ 0	O.K.
< 0	Error

7.12.2.5 JLINK_CORESIGHT_AddAP()

Allows the user to manually configure the AP-layout of the device J-Link is connected to. This makes sense on targets on which J-Link can not perform a auto-detection of the APs which are present on the target system. Type can only be a known global J-Link DLL AP constant. For a list of all available constants, please refer to *Global DLL constants* .

Prototype

```
int JLINK_CORESIGHT_AddAP(int Index, U32 Type);
```

Parameter	Description
Index	AP Index
Type	AP Type

Return Value

Return value	Description
≥ 0	O.K.
< 0	Error

Example

```
JLINK_CORESIGHT_AddAP(0, CORESIGHT_AHB_AP); // First AP is a AHB-AP
JLINK_CORESIGHT_AddAP(1, CORESIGHT_APB_AP); // Second AP is a APB-AP
JLINK_CORESIGHT_AddAP(2, CORESIGHT_JTAG_AP); // Third AP is a JTAG-AP
```

7.12.2.6 JLINK_CORESIGHT_Configure()

Has to be called once, before using any other `_CORESIGHT_` function that accesses the DAP. Takes a configuration string to prepare target and J-Link for CoreSight function usage. Configuration string may contain multiple setup parameters that are set. Setup parameters are separated by a semicolon.

At the end of the `JLINK_CORESIGHT_Configure()`, the appropriate target interface switching sequence for the currently active target interface is output, if not disabled via setup parameter.

This function has to be called again, each time the JTAG chain changes (for dynamically changing JTAG chains like those which include a TI ICEPick), in order to setup the JTAG chain again.

For JTAG

The SWD -> JTAG switching sequence is output. This also triggers a TAP reset on the target (TAP controller goes through -> Reset -> Idle state) The IRPre, DRPre, IRPost, DRPost parameters describe which device inside the JTAG chain is currently selected for communication.

For SWD

The JTAG -> SWD switching sequence is output. It is also made sure that the "overrun mode enable" bit in the SW-DP CTRL/STAT register is cleared, as in SWD mode J-Link always assumes that overrun detection mode is disabled.

Make sure that this bit is NOT set by accident when writing the SW-DP CTRL/STAT register via the `_CORESIGHT_` functions.

Prototype

```
int JLINK_CORESIGHT_Configure(const char* sConfig);
```

Return Value

Return value	Description
≥ 0	O.K.
< 0	Error
$= -2$	Not supported by the current CPU + target interface combination

Example

```
if (JLINK_ActiveTIF == JLINK_TIF_JTAG) {
    // Simple setup where we have TDI -> Cortex-M (4-bits IRLen) -> TDO
    JLINK_CORESIGHT_Configure("IRPre=0;DRPre=0;IRPost=0;DRPost=0;IRLenDevice=4");
} else {
    // For SWD, no special setup is needed, just output the switching sequence
    JLINK_CORESIGHT_Configure("");
}
v = JLINK_CORESIGHT_ReadDP(JLINK_CORESIGHT_DP_REG_CTRL_STAT);
JLINK_SYS_Report1("DAP-CtrlStat: " v);
// Complex setup where we have
// TDI -> ICEPick (6-bits IRLen) -> Cortex-M (4-bits IRLen) -> TDO
JLINK_CORESIGHT_Configure("IRPre=0;DRPre=0;IRPost=6;DRPost=1;IRLenDevice=4");
v = JLINK_CORESIGHT_ReadDP(JLINK_CORESIGHT_DP_REG_CTRL_STAT);
JLINK_SYS_Report1("DAP-CtrlStat: " v);
```

Known setup parameters

Parameter	Type	Explanation
IRPre	DecValue	Sum of IRLen of all JTAG devices in the JTAG chain, closer to TDO than the actual one J-Link shall communicate with.
DRPre	DecValue	Number of JTAG devices in the JTAG chain, closer to TDO than the actual one, J-Link shall communicate with.
IRPost	DecValue	Sum of IRLen of all JTAG devices in the JTAG chain, following the actual one, J-Link shall communicate with.
DRPost	DecValue	Number of JTAG devices in the JTAG chain, following the actual one, J-Link shall communicate with.
IRLenDevice	DecValue	IRLen of the actual device, J-Link shall communicate with.
PerformTIFInit	DecValue	0: Do not output switching sequence etc. once JLINK_CORESIGHT_Configure() completes.

7.12.2.7 JLINK_CORESIGHT_ReadAP()

Reads a specific AP register. For JTAG, makes sure that AP is selected automatically. Makes sure that actual data is returned, meaning for register read-accesses which usually only return data on the second access, this function performs this automatically, so the user will always see valid data.

Prototype

```
int JLINK_CORESIGHT_ReadAP(int RegIndex);
```

Parameter	Description
RegIndex	Specifies the index of the AP register to read.

Return value	Description
≠ -1	Data read
= -1	Error

Example

```
v = JLINK_CORESIGHT_ReadAP(JLINK_CORESIGHT_AP_REG_DATA);
JLINK_SYS_Report1("DATA: " v);
```

7.12.2.8 JLINK_CORESIGHT_ReadDP()

Reads a specific DP register. For JTAG, makes sure that DP is selected automatically. Makes sure that actual data is returned, meaning for register read-accesses which usually only return data on the second access, this function performs this automatically, so the user will always see valid data.

Prototype

```
int JLINK_CORESIGHT_ReadDP(int RegIndex);
```

Parameter	Description
RegIndex	Specifies the index of the DP register to read.

Return value	Description
≠ -1	Data read
= -1	Error

Example

```
v = JLINK_CORESIGHT_ReadDP(JLINK_CORESIGHT_DP_REG_IDCODE);
JLINK_SYS_Report1("DAP-IDCODE: " v);
```

7.12.2.9 JLINK_CORESIGHT_ReadDAP()

Reads a specific AP/DP register. For JTAG, makes sure that AP/DP is selected automatically. Makes sure that actual data is returned, meaning for register read-accesses which usually only return data on the second access, this function performs this automatically, so the user will always see valid data.

Prototype

```
int JLINK_CORESIGHT_ReadDAP(int RegIndex, int APnDP, U32* Data);
```

Parameter	Description
RegIndex	Specifies the index of the AP/DP register to read.
APnDP	0: DP register 1: AP register
Data	Pointer to buffer for data read

Return Value

Return value	Description
≥ 0	O.K. (Number of repetitions needed before read was accepted / returned valid data)
< 0	Error

Example

```
JLINK_CORESIGHT_ReadDAP(JLINK_CORESIGHT_DP_REG_IDCODE, 0, v);
JLINK_SYS_Report1("DAP-IDCODE: " v);
```

7.12.2.10 JLINK_CORESIGHT_WriteAP()

Writes a specific AP register. For JTAG, makes sure that AP is selected automatically.

Prototype

```
int JLINK_CORESIGHT_WriteAP(int RegIndex, U32 Data);
```

Parameter	Description
RegIndex	Specifies the index of the AP register to write.
Data	Data to be written

Return Value

Return value	Description
≥ 0	O.K. (Number of repetitions needed before write was accepted)
< 0	Error
$= -2$	Not supported by the current CPU + target interface combination

Example

```
JLINK_CORESIGHT_WriteAP(JLINK_CORESIGHT_AP_REG_BD1, 0x1E);
```

7.12.2.11 JLINK_CORESIGHT_WriteDP()

Writes a specific DP register. For JTAG, makes sure that DP is selected automatically.

Prototype

```
int JLINK_CORESIGHT_WriteDP(int RegIndex, U32 Data);
```

Parameter	Description
RegIndex	Specifies the index of the DP register to write.
Data	Data to be written

Return Value

Return value	Description
≥ 0	O.K. (Number of repetitions needed before write was accepted)
< 0	Error
$= -2$	Not supported by the current CPU + target interface combination

Example

```
JLINK_CORESIGHT_WriteDP(JLINK_CORESIGHT_DP_REG_ABORT, 0x1E);
```

7.12.2.12 JLINK_CORESIGHT_WriteDAP()

Writes to a CoreSight AP/DP register. This function performs a full-qualified write which means that it tries to write until the write has been accepted or too many WAIT responses have been received.

Prototype

```
int JLINK_CORESIGHT_WriteDAP(int RegIndex, int APnDP, U32 Data);
```

Parameter	Description
RegIndex	Specifies the index of the AP/DP register to write.
APnDP	0: DP register 1: AP register
Data	Data to be written

Return Value

Return value	Description
≥ 0	O.K. (Number of repetitions needed before write was accepted)
< 0	Error
$= -2$	Not supported by the current CPU + target interface combination

Example

```
JLINK_CORESIGHT_WriteDAP(JLINK_CORESIGHT_DP_REG_ABORT, 0, 0x1E);
```

7.12.2.13 JLINK_ExecCommand()

Gives the option to use *J-Link Command Strings* in the J-Link script file.

Prototype

```
int JLINK_ExecCommand(const char* sMsg);
```

Return Value

Return value	Description
≥ 0	O.K.
< 0	Error

Example

```
JLINK_ExecCommand("TraceSampleAdjust TD=2000");
```

Note

Has no effect when executed in Flasher stand-alone mode or when calling this function from a function that implements the `__probe` attribute.

7.12.2.14 JLINK_GetTime()

Returns J-Link (DLL) uptime in milliseconds.
Intended usage: timeouts and time measurements.

Prototype

```
int JLINK_GetTime(void);
```

7.12.2.15 JLINK_GetPinState()

Gets the state of a specific pin.

Prototype

```
int JLINK_GetPinState(U8 iPin);
```

Parameter	Description
iPin	Specifies the pin to get the state from

Parameter iPin

Value	Description
0	Pin 3
1	Pin 5
2	Pin 7
3	Pin 9
4	Pin 11
5	Pin 13
6	Pin 15
7	Pin 17

Return Value

Return value	Description
= 1	Pin state is HIGH
= 0	Pin state is LOW
< 0	Getting state for this pin is not supported by this J-Link

7.12.2.16 JLINK_JTAG_GetDeviceId()

Retrieves the JTAG ID of a specified device, in the JTAG chain. The index of the device depends on its position in the JTAG chain. The device closest to TDO has index 0.

Prototype

```
int JLINK_JTAG_GetDeviceId(int DeviceIndex);
```

Return Value

Return value	Description
> 0	Device ID
= 0	No JTAG device found at Index

Example

```

/*****
 *
 *     SetupTarget
 */
int SetupTarget(void) {
    int r;
    r = JLINK_JTAG_GetDeviceId(0);
    JLINK_SYS_Report1("Device 0: ", r);
    r = JLINK_JTAG_GetDeviceId(1);
    JLINK_SYS_Report1("Device 1: ", r);

    return 0;
}

```

Example output on STM32F103ZG:

```

Device 0: 0x3BA00477
Device 1: 0x06430041

```

7.12.2.17 JLINK_JTAG_GetU32()

Gets 32 bits JTAG data, starting at given bit position.

Prototype

```
int JLINK_JTAG_GetU32(int BitPos);
```

7.12.2.18 JLINK_JTAG_ReadWriteBits()

This function stores the specified number of bits in the output buffers, transfers the whole content of the output buffers to the JTAG device(s) and stores the received data in the input buffer.

Prototype

```
int JLINK_JTAG_ReadWriteBits(const U8 * pTDI, U8 * pTMS, U8 * pTDO, unsigned NumBits);
```

Parameter	Description
pTDI	Pointer to input buffer
pTMS	Pointer to mode select buffer
pTDO	Pointer to output buffer
NumBits	Number of bits to read and write

Return Value

Return value	Description
≥ 0	O.K.
< 0	Error

7.12.2.19 JLINK_JTAG_Reset()

Performs a TAP reset and tries to auto-detect the JTAG chain (Total IRLen, Number of devices). If auto-detection was successful, the global DLL variables which determine the JTAG chain configuration, are set to the correct values. For more information about the known global DLL variables, please refer to *Global DLL variables* .

Note

This will not work for devices which need some special init (for example to add the core to the JTAG chain), which is lost at a TAP reset.

Prototype

```
int JLINK_JTAG_Reset(void);
```

Return Value

Return value	Description
≥ 0	O.K.
< 0	Error

7.12.2.20 JLINK_JTAG_SetDeviceId()

Sets the JTAG ID of a specified device, in the JTAG chain. The index of the device depends on its position in the JTAG chain. The device closest to TDO has index 0. The Id is used by the DLL to recognize the device. Before calling this function, please make sure that the JTAG chain has been configured correctly by setting the appropriate global DLL variables. For more information about the known global DLL variables, please refer to *Global DLL variables*.

Prototype

```
int JLINK_JTAG_SetDeviceId(int DeviceIndex, U32 Id);
```

Return Value

Return value	Description
≥ 0	O.K.
< 0	Error

7.12.2.21 JLINK_JTAG_StartDR()

Brings the state machine of the selected device in the JTAG-chain in SHIFT-DR state.

Prototype

```
int JLINK_JTAG_StartDR(void);
```

Return Value

Return value	Description
≥ 1	Bit position in JTAG buffer
$= 0$	Error

7.12.2.22 JLINK_JTAG_Store()

Stores a JTAG sequence (max. 64 bits per pin) in the DLL JTAG buffer.

Prototype

```
int JLINK_JTAG_Store(U32 tms, U32 tdi, U32 NumBits);
```

Parameter	Description
tms	Bitmask to output on TMS
tdi	Bitmask to output on TDI
NumBits	NumBits to store for each pin. Maximum 32.

Return Value

Return value	Description
≥ 0	O.K.
< 0	Error

7.12.2.23 JLINK_JTAG_StoreClocks()

Stores a given number of clocks in the DLL JTAG buffer.

Prototype

```
int JLINK_JTAG_StoreClocks(int NumClocks);
```

Return Value

Return value	Description
≥ 0	O.K.
< 0	Error

7.12.2.24 JLINK_JTAG_StoreDR()

Stores JTAG data in the DLL JTAG buffer.

Before calling this function, please make sure that the JTAG chain has been configured correctly by setting the appropriate global DLL variables. For more information about the known global DLL variables, please refer to *Global DLL variables* .

Prototype

```
int JLINK_JTAG_StoreDR(U32 tdi, int NumBits);
```

Parameter	Description
tdi	Bitmask to output on TDI
NumBits	NumBits to store

Return Value

Returns the bit position.

7.12.2.25 JLINK_JTAG_StoreIR()

Stores a JTAG instruction in the DLL JTAG buffer.

Before calling this function, please make sure that the JTAG chain has been configured correctly by setting the appropriate global DLL variables. For more information about the known global DLL variables, please refer to *Global DLL variables* .

Prototype

```
int JLINK_JTAG_StoreIR(U32 Cmd);
```

Return Value

Returns the bit position.

7.12.2.26 JLINK_JTAG_Write()

Writes a JTAG sequence (max. 64 bits per pin).

Prototype

```
int JLINK_JTAG_Write(U32 tms, U32 tdi, U32 NumBits);
```

Parameter	Description
tms	Bitmask to output on TMS
tdi	Bitmask to output on TDI
NumBits	NumBits to write

Return Value

Return value	Description
≥ 0	O.K.
< 0	Error

7.12.2.27 JLINK_JTAG_WriteClocks()

Writes a given number of clocks.

Prototype

```
int JLINK_JTAG_WriteClocks(int NumClocks);
```

Return Value

Return value	Description
≥ 0	O.K.
< 0	Error

7.12.2.28 JLINK_JTAG_WriteDR()

Writes JTAG data. Before calling this function, please make sure that the JTAG chain has been configured correctly by setting the appropriate global DLL variables. For more information about the known global DLL variables, please refer to *Global DLL variables* .

Prototype

```
int JLINK_JTAG_WriteDR(U32 tdi, int NumBits);
```

Parameter	Description
tdi	Bitmask to output on TDI
NumBits	NumBits to store

Return Value

Returns the bit position.

7.12.2.29 JLINK_JTAG_WriteDRCont()

Writes data of variable length and remains in UPDATE-DR state. This function expects that the JTAG chain has already be configured before. It does not try to perform any JTAG identification before sending the DR-data.

Prototype

```
int JLINK_JTAG_WriteDRCont(U32 Data, int NumBits);
```

Return Value

Returns the bit position.

7.12.2.30 JLINK_JTAG_WriteDREnd()

Writes data of variable length and remains in UPDATE-DR state. This function expects that the JTAG chain has already be configured before. It does not try to perform any JTAG identification before sending the DR-data.

Prototype

```
int JLINK_JTAG_WriteDREnd(U32 Data, int NumBits);
```

Return Value

Returns the bit position.

7.12.2.31 JLINK_JTAG_WriteIR()

Writes a JTAG instruction.

Before calling this function, please make sure that the JTAG chain has been configured correctly by setting the appropriate global DLL variables. For more information about the known global DLL variables, please refer to *Global DLL variables* .

Prototype

```
int JLINK_JTAG_WriteIR(U32 Cmd);
```

Return Value

Returns the bit position.

7.12.2.32 JLINK_PIN_Override()

This function allows to override some of the J-Link pins and assign a special functionality to them (GPIO, UART, ...). For example setting the functionality to GPIO allows to implement almost any protocol on these pins which can give some extra flexibility in some cases.

Prototype

```
int JLINK_PIN_Override(const U32* paMode, U32* paState);
```

Parameter	Description
paMode	Pointer to JLINK_PIN_MAX_NUM_PINS-element array that holds the configuration to be assigned to the pins. Each element of the array describes a pin that can be overridden, resulting in a total of JLINK_PIN_MAX_NUM_PINS pins that can be overridden.
paState	Pointer to JLINK_PIN_MAX_NUM_PINS-element array that is used to store the state of each pin. This for example can be used to read the current data on the pin, if it is configured as JLINK_PIN_OVERRIDE_MODE_PIO_IN. State may be = 0 for LOW or = 1 for HIGH.

Array offset of paMode / paState to Pin No mapping

Array element	Description
0	Pin 3
1	Pin 5
2	Pin 7
3	Pin 9
4	Pin 11
5	Pin 13
6	Pin 15
7	Pin 17

Possible values passed via paMode

Value	Description
JLINK_PIN_OVERRIDE_MODE_RELEASE	Releases the override on this pin. It returns to its original functionality.
JLINK_PIN_OVERRIDE_MODE_PIO_IN	Configures the pin as GPIO input.
JLINK_PIN_OVERRIDE_MODE_PIO_OUT_LOW	Configures the pin as GPIO output state LOW.
JLINK_PIN_OVERRIDE_MODE_PIO_OUT_HIGH	Configures the pin as GPIO output state HIGH.
JLINK_PIN_OVERRIDE_MODE_UART_TX	Configures the pin as UART Tx pin.
JLINK_PIN_OVERRIDE_MODE_UART_RX	Configures the pin as UART rx pin.
JLINK_PIN_OVERRIDE_MODE_UART_RTX	Configures pin for half-duplex UART functionality which means this pin in Tx and Rx. Cannot be used together with other UART defines.

Return Value

Return value	Description
≥ 0	O.K.
< 0	Error

Example

The following example shows how to output a default->low->(wait 2500ms)->high->(wait 2500ms)->default signal on pin 15 (= nRESET) after InitTarget()

```

U32 _aPINMode[8]; // JLINK_PIN_MAX_NUM_PINS
U32 _aPINState[8]; // JLINK_PIN_MAX_NUM_PINS

/*****
 *
 *     SetupTarget
 */
int SetupTarget(void) {
    int i;

```

```

int r;

i = 0;
do {
    _aPINMode[i] = JLINK_PIN_OVERRIDE_MODE_RELEASE;
    // Do not override any pin by default
    i += 1;
} while(i < JLINK_PIN_MAX_NUM_PINS);
//
// Initially, we check if pin override is supported
//
r = JLINK_PIN_Override(&_amp;PINMode[0], &_amp;PINState[0]);
if (r < 0) {
    JLINK_SYS_Report("ERROR: Pin override is not supported by the connected J-
Link");
    return r;
}
_aPINMode[6] = JLINK_PIN_OVERRIDE_MODE_PIO_OUT_LOW;
r = JLINK_PIN_Override(&_amp;PINMode[0], &_amp;PINState[0]);
JLINK_SYS_Sleep(2500);
_aPINMode[6] = JLINK_PIN_OVERRIDE_MODE_PIO_OUT_HIGH;
r = JLINK_PIN_Override(&_amp;PINMode[0], &_amp;PINState[0]);
JLINK_SYS_Sleep(2500);
//
// Restore pin configuration of J-Link
//
i = 0;
do {
    _aPINMode[i] = JLINK_PIN_OVERRIDE_MODE_RELEASE;
    // Do not override any pin by default
    i += 1;
} while(i < JLINK_PIN_MAX_NUM_PINS);
JLINK_PIN_Override(&_amp;PINMode[0], &_amp;PINState[0]);
return 0;
}

```

7.12.2.33 JLINK_MemRegion()

This command is used to specify memory areas with various region types.

Prototype

```
int JLINK_MemRegion(const char* sConfig);
```

Syntax of sConfig

```
<StartAddressOfArea>-<EndAddressOfArea> <RegionType>
```

Parameter RegionType

Region type	Description
N	Normal
C	Cacheable
X	Excluded
XI	Excluded & Illegal
I	Indirect access
A	Alias (static, e.g. RAM/flash that is aliased multiple times in one area. Does not change during the debug session.)
AD	Alias (dynamic, e.g. memory areas where different memories can be mapped to.)

Return value	Description
≥ 0	O.K.
< 0	Error

Example

```
JLINK_MemRegion("0x100000-0x1FFFFFF C")
```

Note

Has no effect when executed in Flasher stand-alone mode or when calling this function from a function that implements the `__probe` attribute.

7.12.2.34 JLINK_MEM_WriteU8()

Writes a byte to the specified address.

Prototype

```
int JLINK_MEM_WriteU8(U32 Addr, U32 Data);
```

Return value	Description
≥ 0	O.K.
< 0	Error

7.12.2.35 JLINK_MEM_WriteU16()

Writes a halfword to the specified address.

Prototype

```
int JLINK_MEM_WriteU16(U32 Addr, U32 Data);
```

Return value	Description
≥ 0	O.K.
< 0	Error

7.12.2.36 JLINK_MEM_WriteU32()

Writes a word to the specified address.

Prototype

```
int JLINK_MEM_WriteU32(U32 Addr, U32 Data);
```

Return value	Description
≥ 0	O.K.
< 0	Error

7.12.2.37 JLINK_MEM_ReadU8()

Reads a byte from the specified address.

Prototype

```
U8 MEM_ReadU8 (U32 Addr);
```

7.12.2.38 JLINK_MEM_ReadU16()

Reads a halfword from the specified address.

Prototype

```
U16 MEM_ReadU16(U32 Addr);
```

7.12.2.39 JLINK_MEM_ReadU32()

Reads a word from the specified address.

Prototype

```
U32 MEM_ReadU32(U32 Addr);
```

7.12.2.40 JLINK_MEM_Preserve()

Preserves selected memory area in amount of set size.

Prototype

```
int JLINK_MEM_Preserve(U32 Addr, U32 NumBytes);
```

Parameter	Description
Addr	Specifies the address starting point which to preserve
NumBytes	Number of bytes to preserve

Return Value

Return value	Description
≥ 0	O.K., handle to preserved area (may be used by JLINK_MEM_Restore())
< 0	Error
-1	Unspecified error
-2	Failed to read memory to preserve

7.12.2.41 JLINK_MEM_Restore()

Restore memory that has been previously preserved via JLINK_MEM_Preserve(). Returned handle is used to identify the restore region.

Prototype

```
int JLINK_MEM_Restore(int Handle);
```

Parameter	Description
Handle	Specifies handle to identify the restore region

Return Value

Return value	Description
≥ 0	O.K.
< 0	Error
-1	Unspecified error
-2	Failed to write memory to restore

7.12.2.42 JLINK_MEM_Fill()

Fill memory with given value. Only the lowest byte of <FillVal> is taken into account.

Prototype

```
int JLINK_MEM_Fill(U32 Addr, U32 NumBytes, U32 FillVal);
```

Parameter	Description
Addr	Specifies the address starting point which to preserve
NumBytes	Number of bytes to preserve
FillVal	Value used for filling

Return Value

Return value	Description
≥ 0	O.K., handle to preserved area (may be used by JLINK_MEM_Restore())
< 0	Error
-1	Unspecified error
-2	Failed to read memory to fill

7.12.2.43 JLINK_SelectTIF()

Selects a target interface. For a list of all available constants, please refer to [Constants for global variable "JLINK_ActiveTIF"](#).

Prototype

```
void JLINK_SelectTIF(U32 tif);
```

7.12.2.44 JLINK_SetDevice()

Selects / specifies the target device.

Prototype

```
int JLINK_SetDevice(const char* sDevice);
```

sDevice has to be a valid device identifier. For a list of all available device identifiers, please refer to *Supported devices* .

Return Value

Return value	Description
≥ 0	O.K.

Return value	Description
< 0	Error

Example

```
JLINK_SetDevice("AT91SAM7S256");
```

7.12.2.45 JLINK_SWD_ReadWriteBits()

This function stores the specified number of bits in the output buffers, transfers the whole content of the output buffers to the SWD device and stores the received data in the input buffer.

Prototype

```
int JLINK_SWD_ReadWriteBits(const U8 * pDataIn, const U8 * pDirection, U8 *
pDataOut, int NumBits);
```

Parameter	Description
pDataIn	Pointer to data to be send to the target
pDirection	Pointer to direction buffer
pDataOut	Pointer to buffer for receiving data from target
NumBits	Number of bits to read and write

Return Value

Return value	Description
≥ 0	O.K.
< 0	Error

7.12.2.46 JLINK_SYS_MessageBox()

Outputs a string in a message box.

Prototype

```
int JLINK_SYS_MessageBox(const char * sMsg);
```

Return value	Description
≥ 0	O.K.
< 0	Error

7.12.2.47 JLINK_SYS_MessageBox1()

Outputs a constant character string in a message box. In addition to that, a given value (can be a constant value, the return value of a function or a variable) is added, right behind the string.

Prototype

```
int JLINK_SYS_MessageBox1(const char * sMsg, int v);
```

Return value	Description
≥ 0	O.K.

Return value	Description
< 0	Error

7.12.2.48 JLINK_SYS_Report()

Outputs a constant character string on stdio.

Prototype

```
int JLINK_SYS_Report(const char * sMsg);
```

Return value	Description
≥ 0	O.K.
< 0	Error

7.12.2.49 JLINK_SYS_Report1()

Outputs a constant character string on stdio. In addition to that, a given value (can be a constant value, the return value of a function or a variable) is added, right behind the string.

Prototype

```
int JLINK_SYS_Report1(const char * sMsg, int v);
```

Return value	Description
≥ 0	O.K.
< 0	Error

7.12.2.50 JLINK_SYS_Sleep()

Waits for a given number of milliseconds. During this time, J-Link does not communicate with the target.

Prototype

```
int JLINK_SYS_Sleep(int Delayms);
```

Return value	Description
≥ 0	O.K.
< 0	Error

7.12.2.51 JLINK_SYS_UnsecureDialog()

Informs the user that the device needs to be unsecured for further debugging. This is usually done via a message box where possible (except on Linux & Mac).

Prototype

```
int JLINK_SYS_UnsecureDialog (const char* sText, const char* sQuestion, const char* sIdent, int DefaultAnswer, U32 Flags);
```

Parameter	Description
sText	Text printed to the logfile or presented in a message box
sQuestion	Question printed in the message box after sText

Parameter	Description
sIdent	Unique ID for the request. User settings like "Do not show again" are saved per Unique ID.
DefaultAnswer	Default answer for messages with timeout or non-GUI versions. Only used if not setting is saved for the Unique ID.
Flags	Please consult the table below for valid values. Specifying a valid JLINK_DLG_TYPE flag is mandatory.

Parameter Flags

Value	Description
JLINK_DLG_TYPE_PROT_READ	Read protection dialog
JLINK_DLG_TYPE_PROT_WRITE	Write protection dialog

Return Value

Return value	Description
= 1	User selected to unsecure the device
= 0	User selected to NOT unsecure the device

Note

If executed in Flasher stand-alone mode or when calling this function from a function that implements the __probe attribute, no dialog is shown but the default answer is used

7.12.2.52 JLINK_TARGET_IsHalted()

Checks if the target device is halted.

Prototype

```
int JLINK_TARGET_IsHalted(void);
```

Return Value

Return value	Description
= 1	O.K. CPU is halted
= 0	O.K. CPU is not halted
< 0	Error

Example

```

/*****
 *
 *      SetupTarget
 */
int SetupTarget(void) {
    int r;

    r = JLINK_TARGET_IsHalted();
    if (r == 0) {
        JLINK_SYS_Report("Target is not halted!");
    } else if (r == 1) {
        JLINK_SYS_Report("Target is halted!");
    }
}

```

```

    } else {
        JLINK_SYS_Report("Error occurred!");
    }
    return 0;
}

```

7.12.2.53 JLINK_TARGET_Halt()

Halt the target device. Returns O.K. if the target is already halted.

Prototype

```
int JLINK_TARGET_Halt(void);
```

Return Value

Return value	Description
=> 1	Error
= 0	O.K.

Example

```

/*****
 *
 *      SetupTarget
 */
int SetupTarget(void) {
    int r;

    r = JLINK_TARGET_Halt();
    if (r == 0) {
        JLINK_SYS_Report("Target is halted!");
    } else {
        JLINK_SYS_Report("Error occurred!");
    }
    return 0;
}

```

7.12.2.54 JLINK_TIF_ActivateTargetReset()

Sets nReset LOW.

Prototype

```
void JLINK_TIF_ActivateTargetReset(void);
```

7.12.2.55 JLINK_TIF_ReleaseTargetReset()

Sets nReset HIGH.

Prototype

```
void JLINK_TIF_ReleaseTargetReset(void);
```

7.12.2.56 JLINK_TIF_SetClrTCK()

Sets or clears the TCK pin.

Prototype

```
void JLINK_TIF_SetClrTCK(int OnOff);
```

Parameter	Description
OnOff	Desired state of TCK

Parameter OnOff

Value	Description
≥ 1	Set pin to HIGH
= 0	Set pin to LOW

7.12.2.57 JLINK_TIF_SetClrTMS()

Sets or clears the TMS pin.

Prototype

```
void JLINK_TIF_SetClrTMS(int OnOff);
```

Parameter	Description
OnOff	Desired state of TMS

Parameter OnOff

Value	Description
≥ 1	Set pin to HIGH
= 0	Set pin to LOW

7.12.2.58 JLINK_TIF_SetClrTDI()

Sets or clears the TCK pin.

Prototype

```
void JLINK_TIF_SetClrTDI(int OnOff);
```

Parameter	Description
OnOff	Desired state of TDI

Parameter OnOff

Value	Description
≥ 1	Set pin to HIGH
= 0	Set pin to LOW

7.12.2.59 JLINK_TIF_SetSpeed()

Sets the target interface speed.

Prototype

```
void JLINK_TIF_SetSpeed(U32 Speed);
```

Parameter	Description
Speed	Speed in kHz.

7.12.3 Global DLL variables

The script file feature also provides some global variables which are used for DLL configuration. Some of these variables can only be set to some specific values, others can be

set to the whole data type with. In the following all global variables and their value ranges are listed and described.

Note

All global variables are treated as unsigned 32-bit values and are zero-initialized.

Legend

Abbreviation	Description
RO:	Variable is read-only
WO:	Variable is write-only
R/W:	Variable is read-write

Variable	Description	R/W
CPU	Pre-selects target CPU J-Link is communicating with. Used in InitTarget() to skip the core autodetection of J-Link. This variable can only be set to a known global J-Link DLL constant. For a list of all valid values, please refer to <i>Global DLL constants</i> Example CPU = ARM926EJS;	WO
JTAG_IRPre	Used for JTAG chain configuration. Sets the number of IR-bits of all devices which are closer to TDO than the one we want to communicate with. Example JTAG_IRPre = 6;	R/W
JTAG_DRPre	Used for JTAG chain configuration. Sets the number of devices which are closer to TDO than the one we want to communicate with. Example JTAG_DRPre = 2;	RO
JTAG_IRPost	Used for JTAG chain configuration. Sets the number of IR-bits of all devices which are closer to TDI than the one we want to communicate with. Example JTAG_IRPost = 6;	RO
JTAG_DRPost	Used for JTAG chain configuration. Sets the number of devices which are closer to TDI than the one we want to communicate with. Example JTAG_DRPost = 0;	RO
JTAG_IRLen	IR-Len (in bits) of the device we want to communicate with. Example JTAG_IRLen = 4	RO
JTAG_TotalIRLen	Computed automatically, based on the values of JTAG_IRPre, JTAG_DRPre, JTAG_IRPost and JTAG_DRPost. Example v = JTAG_TotalIRLen;	RO
JTAG_AllowTAPReset	En-/Disables auto-JTAG-detection of J-Link. Has to be disabled for devices which need some special init (for example to add the core to the JTAG chain), which is lost at a TAP reset. Allowed values	WO

Variable	Description	R/W
	0 Auto-detection is enabled. 1 Auto-detection is disabled.	
JTAG_Speed	Sets the JTAG interface speed. Speed is given in kHz. Example JTAG_Speed = 2000; // 2MHz JTAG speed	R/W
JTAG_ResetPin	Pulls reset pin low / Releases nRST pin. Used to issue a reset of the CPU. Value assigned to reset pin reflects the state. 0 = Low, 1 = high. Example JTAG_ResetPin = 0; SYS_Sleep(5); // Give pin some time to get low JTAG_ResetPin = 1;	WO
JTAG_TRSTPin	Pulls reset pin low / Releases nTRST pin. Used to issue a reset of the debug logic of the CPU. Value assigned to reset pin reflects the state. 0 = Low, 1 = high. Example JTAG_TRSTPin = 0; SYS_Sleep(5); // Give pin some time to get low JTAG_TRSTPin = 1;	WO
JTAG_TCKPin	Pulls TCK pin LOW / HIGH. Value assigned to reset pin reflects the state. 0 = LOW, 1 = HIGH. Example JTAG_TCKPin = 0;	R/W
JTAG_TDIpin	Pulls TDI pin LOW / HIGH. Value assigned to reset pin reflects the state. 0 = LOW, 1 = HIGH. Example JTAG_TDIpin = 0;	R/W
JTAG_TMSpin	Pulls TMS pin LOW / HIGH. Value assigned to reset pin reflects the state. 0 = LOW, 1 = HIGH. Example JTAG_TMSpin = 0;	R/W
JLINK_TRACE_Portwidth	Sets or reads Trace Port width. Possible values: 1,2, 4. Default value is 4. Example JLINK_TRACE_Portwidth = 4;	R/W
EMU_ETB_IsPresent	If the connected device has an ETB and you want to use it with J-Link, this variable should be set to 1. Setting this variable in another function as InitEmu() does not have any effect. Example void InitEmu(void) { EMU_ETB_IsPresent = 1; }	WO
EMU_ETB_UseETB	Uses ETB instead of RAWTRACE capability of the emulator. Setting this variable in another function as InitEmu() does not have any effect. Example EMU_ETB_UseETB = 0;	RO
EMU_ETM_IsPresent	Selects whether an ETM is present on the target or not. Setting this variable in another function as InitEmu() does not have any effect. Example EMU_ETM_IsPresent= 0;	R/W
EMU_ETM_UseETM	Uses ETM as trace source. Setting this variable in another function as InitEmu() does not have any effect.	WO

Variable	Description	R/W
	<p>Example EMU_ETM_UseETM = 1;</p>	
EMU_JTAG_DisableHW-Transmissions	<p>Disables use of hardware units for JTAG transmissions since this can cause problems on some hardware designs.</p> <p>Example EMU_JTAG_DisableHWTransmissions = 1;</p>	WO
CORESIGHT_CoreBaseAddr	<p>Sets base address of core debug component for CoreSight compliant devices. Setting this variable disables the J-Link auto-detection of the core debug component base address. Used on devices where auto-detection of the core debug component base address is not possible due to incorrect CoreSight information.</p> <p>Example CORESIGHT_CoreBaseAddr = 0x80030000;</p>	R/W
CORESIGHT_IndexAHBAPToUse	<p>Pre-selects an AP as an AHB-AP that J-Link uses for debug communication (Cortex-M). Setting this variable is necessary for example when debugging multi-core devices where multiple AHB-APs are present (one for each device). This function can only be used if a AP-layout has been configured via <i>JLINK_CORESIGHT_AddAP()</i> .</p> <p>Example JLINK_CORESIGHT_AddAP(0, CORESIGHT_AHB_AP); JLINK_CORESIGHT_AddAP(1, CORESIGHT_AHB_AP); JLINK_CORESIGHT_AddAP(2, CORESIGHT_APB_AP); // // Use second AP as AHB-AP // for target communication // CORESIGHT_IndexAHBAPToUse = 1;</p>	WO
CORESIGHT_IndexAPBAPToUse	<p>Pre-selects an AP as an APB-AP that J-Link uses for debug communication (Cortex-A/R). Setting this variable is necessary for example when debugging multi-core devices where multiple APB-APs are present (one for each device). This function can only be used if an AP-layout has been configured via <i>JLINK_CORESIGHT_AddAP()</i> .</p> <p>Example JLINK_CORESIGHT_AddAP(0, CORESIGHT_AHB_AP); JLINK_CORESIGHT_AddAP(1, CORESIGHT_APB_AP); JLINK_CORESIGHT_AddAP(2, CORESIGHT_APB_AP); // // Use third AP as APB-AP // for target communication // CORESIGHT_IndexAPBAPToUse = 2;</p>	WO
CORESIGHT_AHBAPCSWDefaultSettings	<p>Overrides the default settings to be used by the DLL when configuring the AHB-AP CSW register. By default, the J-Link DLL will use the following settings for the CSW:</p> <p>Cortex-M0, M0+, M3, M4 [30] = 0 [28] = 0 [27] = 0 [26] = 0 [25] = 1 [24] = 1</p>	WO

Variable	Description	R/W
	<p>Configurable settings</p> <p>[30] = SPROT: 0 = secure transfer request [28] = HRPOT[4]: Always 0 [27] = HRPOT[3]: 0 = uncachable [26] = HRPOT[2]: 0 = unbufferable [25] = HRPOT[1]: 0 = unprivileged [24] = HRPOT[0]: 1 = Data access</p>	
MAIN_ResetType	<p>Used to determine what reset type is currently selected by the debugger. This is useful, if the script has to behave differently in case a specific reset type is selected by the debugger and the script file has a ResetTarget() function which overrides the J-Link reset strategies.</p> <p>Example</p> <pre>if (MAIN_ResetType = 2) { [...] } else { [...] }</pre>	RO
JLINK_ActiveTIF	<p>Returns the currently used target interface used by the DLL to communicate with the target. Useful in cases where some special setup only needs to be done for a certain target interface, e.g. JTAG. For a list of possible values this variable may hold, please refer to Constants for global variable "JLINK_ActiveTIF".</p>	RO
MAIN_IsFirstIdentify	<p>Used to check if this is the first time we are running into InitTarget(). Useful if some init steps only need to be executed once per debug session.</p> <p>Example</p> <pre>if (MAIN_IsFirstIdentify = 1) { [...] } else { [...] }</pre>	RO
JLINK_TargetEndianness	<p>Sets the target data and instruction endianness. For a list of possible values this variable may hold, please refer to Constants for global variable "JLINK_TargetEndianness"</p> <p>Example</p> <pre>JLINK_TargetEndianness = JLINK_TARGET_ENDIANNESS_I_LITTLE_D_LITTLE</pre>	RW
JLINK_SkipInitECCRAMOnConnect	<p>Used to disable ECC RAM init on connect, e.g. in case only a attach to a running CPU shall be performed. Allowed values are 0 (do not skip) or 1 (skip).</p> <p>Example</p> <pre>SetSkipInitECCRAMOnConnect = 1</pre>	RW

7.12.4 Global DLL constants

Currently there are only global DLL constants to set the global DLL variable [CPU](#). If necessary, more constants will be implemented in the future.

7.12.4.1 Constants for global variable: CPU

The following constants can be used to set the global DLL variable [CPU](#):

- ARM7
- ARM7TDMI

- ARM7TDMIR3
- ARM7TDMIR4
- ARM7TDMIS
- ARM7TDMISR3
- ARM7TDMISR4
- ARM9
- ARM9TDMIS
- ARM920T
- ARM922T
- ARM926EJS
- ARM946EJS
- ARM966ES
- ARM968ES
- ARM11
- ARM1136
- ARM1136J
- ARM1136JS
- ARM1136JF
- ARM1136JFS
- ARM1156
- ARM1176
- ARM1176J
- ARM1176JS
- ARM1176IF
- ARM1176JFS
- CORTEX_M0
- CORTEX_M1
- CORTEX_M3
- CORTEX_M3R1P0
- CORTEX_M3R1P1
- CORTEX_M3R2P0
- CORTEX_M4
- CORTEX_M7
- CORTEX_A5
- CORTEX_A7
- CORTEX_A8
- CORTEX_A9
- CORTEX_A12
- CORTEX_A15
- CORTEX_A17
- CORTEX_R4
- CORTEX_R5

7.12.4.2 Constants for "JLINK_CORESIGHT_xxx" functions

APs

- CORESIGHT_AHB_AP
- CORESIGHT_APB_AP
- CORESIGHT_JTAG_AP
- CORESIGHT_CUSTOM_AP

DP/AP register indexes

- JLINK_CORESIGHT_DP_REG_IDCODE
- JLINK_CORESIGHT_DP_REG_ABORT
- JLINK_CORESIGHT_DP_REG_CTRL_STAT
- JLINK_CORESIGHT_DP_REG_SELECT
- JLINK_CORESIGHT_DP_REG_RDBUF
- JLINK_CORESIGHT_AP_REG_CTRL
- JLINK_CORESIGHT_AP_REG_ADDR
- JLINK_CORESIGHT_AP_REG_DATA

- JLINK_CORESIGHT_AP_REG_BD0
- JLINK_CORESIGHT_AP_REG_BD1
- JLINK_CORESIGHT_AP_REG_BD2
- JLINK_CORESIGHT_AP_REG_BD3
- JLINK_CORESIGHT_AP_REG_ROM
- JLINK_CORESIGHT_AP_REG_IDR

7.12.4.3 Constants for global variable "JLINK_ActiveTIF"

- JLINK_TIF_JTAG
- JLINK_TIF_SWD

7.12.4.4 Constants for global variable "JLINK_TargetEndianness"

- JLINK_TARGET_ENDIANNESSE_I_LITTLE_D_LITTLE
- JLINK_TARGET_ENDIANNESSE_I_LITTLE_D_BIG
- JLINK_TARGET_ENDIANNESSE_I_BIG_D_LITTLE
- JLINK_TARGET_ENDIANNESSE_I_BIG_D_BIG

7.12.5 Script file language

The syntax of the J-Link script file language follows the conventions of the C-language, but it does not support all expressions and operators which are supported by the C-language. In the following, the supported operators and expressions are listed.

7.12.5.1 Supported Operators

The following operators are supported by the J-Link script file language:

- Multiplicative operators: *, /, %
- Additive operators: +, -
- Bitwise shift operators: <<, >>
- Relational operators: <, >, ≤, ≥
- Equality operators: =, ≠
- Bitwise operators: &, |, ^
- Logical operators: &&, ||
- Assignment operators: =, *=, /=, +=, -=, <≤, >≥, &=, ^=, |=

7.12.5.2 Supported basic type specifiers

The following basic type specifiers are supported by the J-Link script file language:

Name	Size (Bit)	Signed
void	N/A	N/A
char	8	signed
short	16	signed
int	32	signed
long	32	signed
U8	8	unsigned
U16	16	unsigned
U32	32	unsigned
I8	8	signed
I16	16	signed
I32	32	signed

7.12.5.3 Supported type qualifiers

The following type qualifiers are supported by the J-Link script file language:

- const
- signed
- unsigned

7.12.5.4 Supported declarators

The following declarators are supported by the J-Link script file language:

- Array declarators

7.12.5.5 Supported selection statements

The following selection statements are supported by the J-Link script file language:

- if-statements
- if-else-statements

7.12.5.6 Supported iteration statements

The following iteration statements are supported by the J-Link script file language:

- while
- do-while

7.12.5.7 Jump statements

The following jump statements are supported by the J-Link script file language:

- return

7.12.5.8 Sample script files

The J-Link Software and Documentation Package comes with sample script files for different devices. The sample script files can be found at `$JLINK_INST_DIR$\Samples\JLink\Scripts`.

7.12.6 Script file writing example

In the following, a short example of how a J-Link script file could look like. In this example we assume a JTAG chain with two devices on it (Cortex-A8 4 bits IRLen, custom device 5-bits IRLen).

```
void InitTarget(void) {
    JLINK_SYS_Report("J-Link script example.");
    JTAG_Reset(); // Perform TAP reset and J-Link JTAG auto-detection
    if (JTAG_TotalIRLen != 9) { // Basic check if JTAG chain information matches
        MessageBox("Can not find xxx device");
        return 1;
    }
    JTAG_DRPre = 0; // Cortex-A8 is closest to TDO, no no pre devices
    JTAG_DRPost = 1; // 1 device (custom device) comes after the Cortex-A8
    JTAG_IRPre = 0; // Cortex-A8 is closest to TDO, no no pre IR bits
    JTAG_IRPost = 5; // Custom device after Cortex-A8 has 5 bits IR len
    JTAG_IRLen = 4; // We selected the Cortex-A8, it has 4 bits IRLen
    CPU = CORTEX_A8; // We are connected to a Cortex-A8
    JTAG_AllowTAPReset = 1; // We are allowed to enter JTAG TAP reset
    //
    // We have a non-CoreSight compliant Cortex-A8 here
    // which does not allow auto-detection of the Core debug components base address.
    // so set it manually to overwrite the DLL auto-detection
    //
    CORESIGHT_CoreBaseAddr = 0x80030000;
}
```

7.12.7 Executing J-Link script files

For instructions on how to execute J-Link script files depending on the debug environment used, please refer to:

[SEgger Wiki: Using J-Link Script Files](#)

7.13 J-Link Command Strings

The behavior of the J-Link can be customized via J-Link Command Strings passed to the JLinkARM.dll which controls J-Link. Applications such as J-Link Commander, but also other IDEs, allow passing one or more J-Link Command Strings. Command line strings can be used for passing commands to J-Link (such as switching on target power supply), as well as customize the behavior (by defining memory regions and other things) of J-Link. The use of J-Link Command Strings enables options which are not configurable via dialogs or settings (e.g. in an IDE).

7.13.1 List of available commands

The table below lists and describes the available J-Link Command Strings.

Command	Description
AppendToLogFile	Enables/Disables always appending new loginfo to logfile.
CORESIGHT_SetIndexAHBAP-ToUse	Selects a specific AHB-AP to be used to connect to a Cortex-M device.
CORESIGHT_SetIndexAPBAP-ToUse	Selects a specific APB-AP to be used to connect to a Cortex-A or Cortex-R device.
CORESIGHT_SetETBBaseAddr	Sets ETB base address.
CORESIGHT_SetMTBBaseAddr	Sets MTB base address.
CORESIGHT_SetETMBaseAddr	Sets ETM base address.
CORESIGHT_SetPTMBaseAddr	Sets PTM base address.
CORESIGHT_SetCSTFBaseAddr	Sets Trace Funnel base address.
CORESIGHT_SetTMCBaseAddr	Sets TMC base address.
CORESIGHT_SetTPIUBaseAddr	Sets TPIU base address.
device	Selects the target device.
DisableAutoUpdateFW	Disables automatic firmware update.
DisableCortexMXPSRAutoCorrect-TBit	Disables auto-correction of XPSR T-bit for Cortex-M devices.
DisableFlashBPs	Disables the FlashBP feature.
DisableFlashDL	Disables the J-Link FlashDL feature.
DisableInfoWinFlashBPs	Disables info window for programming FlashBPs.
DisableInfoWinFlashDL	Disables info window for FlashDL.
DisableLowPowerHandlingMode	Disables low-power handling mode
DisableMOEHandling	Disables output of additional information about mode of entry in case the target CPU is halted / entered debug mode.
DisablePowerSupplyOnClose	Disables power supply on close.
EnableAutoUpdateFW	Enables automatic firmware update.
EnableEraseAllFlashBanks	Enables erase for all accessible flash banks.
EnableFlashBPs	Enables the FlashBP feature.
EnableFlashDL	Enables the J-Link FlashDL feature.
EnableInfoWinFlashBPs	Enables info window for programming FlashBPs.
EnableInfoWinFlashDL	Enables info window for FlashDL.
EnableLowPowerHandlingMode	Enables low-power handling mode
EnableMOEHandling	Enables output of additional information about mode of entry in case the target CPU is halted / entered debug mode.
EnableRemarks	Enable detailed output during CPU-detection / connection process.

Command	Description
ExcludeFlashCacheRange	Invalidate flash ranges in flash cache, that are configured to be excluded from flash cache.
HideDeviceSelection	Hide device selection dialog.
HSSLogFile	Logs all HSS-Data to file, regardless of the application using HSS.
InvalidateCache	Invalidates Cache.
InvalidateFW	Invalidating current firmware.
map exclude	Ignores all memory accesses to specified area.
map illegal	Marks a specified memory region as an illegal memory area. Memory accesses to this region are ignored.
map indirectread	Specifies an area which should be read indirect.
map ram	Specifies location of target RAM.
map region	Specifies a memory region.
map reset	Restores the default mapping, which means all memory accesses are permitted.
MemPreserveOnReset	Adds a memory preserve area to the internal list of memory areas.
ProjectFile	Specifies a file or directory which should be used by the J-Link DLL to save the current configuration.
ReadIntoTraceCache	Reads the given memory area into the streaming trace instruction cache.
RTTtelnetAllowNonLocalClient	Allows non local clients to connect to RTT over Telnet.
ScriptFile	Set script file path.
SelectTraceSource	Selects which trace source should be used for tracing.
SetAllowStopMode	Allows/Disallows usage of stop mode for RTT and memory accesses.
SetAllowFlashCache	Enables/Disables flash cache usage.
SetHostIF	Can be used to override the host interface. Please refer to <i>InitEMU()</i> .
SetAllowSimulation	Enables/Disables instruction set simulation.
SetBatchMode	Enables/Disables batch mode.
SetCFIFlash	Specifies CFI flash area.
SetCheckModeAfterRead	Enables/Disables CPSR check after read operations.
SetCompareMode	Specifies the compare mode to be used.
SetCPUConnectIDCODE	Specifies an CPU IDCODE that is used to authenticate the debug probe, when connecting to the CPU.
SetDbgPowerDownOnClose	Used to power-down the debug unit of the target CPU when the debug session is closed.
SetEnableMemCache	Enables/Disables DLL internal memory caching mechanisms that improve performance
SetETBIsPresent	Selects if the connected device has an ETB.
SetETMIsPresent	Selects if the connected device has an ETM.
SetFlashDLNoRMWThreshold	Specifies a threshold when writing to flash memory does not cause a read-modify-write operation.
SetFlashDLThreshold	Set minimum amount of data to be downloaded.
SetIgnoreReadMemErrors	Specifies if read memory errors will be ignored.
SetIgnoreWriteMemErrors	Specifies if write memory errors will be ignored.

Command	Description
SetMonModeDebug	Enables/Disables monitor mode debugging.
SetResetPulseLen	Defines the length of the RESET pulse in milliseconds.
SetResetType	Selects the reset strategy.
SetRestartOnClose	Specifies restart behavior on close.
SetRTTAddr	Set address of the RTT buffer.
SetRTTSearchRanges	Set ranges to be searched for RTT buffer.
SetRTTtelnetPort	Set the port used for RTT telnet.
SetRXIDCode	Specifies an ID Code for Renesas RX devices to be used by the J-Link DLL.
SetSysPowerDownOnIdle	Used to power-down the target CPU, when there are no transmissions between J-Link and target CPU, for a specified time frame.
SetVerifyDownload	Specifies the verify option to be used.
SetWorkRAM	Specifies RAM area to be used by the J-Link DLL.
ShowControlPanel	Opens control panel.
SilentUpdateFW	Update new firmware automatically.
SupplyPower	Activates/Deactivates power supply over pin 19 of the JTAG connector.
SupplyPowerDefault	Activates/Deactivates power supply over pin 19 of the JTAG connector permanently.
SuppressControlPanel	Suppress pop up of the control panel.
SuppressInfoUpdateFW	Suppress information regarding firmware updates.
SWOSetConversionMode	Set SWO Conversion mode.
TraceSampleAdjust	Allows to adjust the sampling timing on the specified pins, inside the J-Trace firmware

7.13.1.1 AppendToLogFile

This command can be used to configure the AppendToLogFile feature. If enabled, new log data will always be appended to an existing logfile. Otherwise, each time a new connection will be opened, existing log data will be overwritten. By default new log data will not be always appended to an existing logfile.

Syntax

```
AppendToLogFile = 0 | 1
```

Example

```
AppendToLogFile 1 // Enables AppendToLogFile
```

7.13.1.2 CORESIGHT_SetIndexAHBAPToUse

This command is used to select a specific AHB-AP to be used when connected to an ARM Cortex-M device. Usually, it is not necessary to explicitly select an AHB-AP to be used, as J-Link auto-detects the AP automatically. For multi-core systems with multiple AHB-APs it might be necessary.

The index selected here is an absolute index. For example, if the connected target provides the following AP layout:

- AP[0]: AHB-AP
- AP[1]: APB-AP
- AP[2]: AHB-AP
- AP[3]: JTAG-AP

In order to select the second AHB-AP to be used, use "2" as index.

Syntax

```
CORESIGHT_SetIndexAHBAPToUse = <Index>
```

Example

```
CORESIGHT_SetIndexAHBAPToUse = 2
```

7.13.1.3 CORESIGHT_SetIndexAPBAPToUse

This command is used to select a specific APB-AP to be used when connected to an ARM Cortex-A or Cortex-R device. Usually, it is not necessary to explicitly select an AHB-AP to be used, as J-Link auto-detects the AP automatically. For multi-core systems with multiple APB-APs it might be necessary.

The index selected here is an absolute index. For example, if the connected target provides the following AP layout:

- AP[0]: APB-AP
- AP[1]: AHB-AP
- AP[2]: APB-AP
- AP[3]: JTAG-AP

In order to select the second APB-AP to be used, use "2" as index.

Syntax

```
CORESIGHT_SetIndexAPBAPToUse = <Index>
```

Example

```
CORESIGHT_SetIndexAPBAPToUse = 2
```

7.13.1.4 CORESIGHT_SetETBBaseAddr

This command can be used to set the Coresight ETB base address if the debug probe could not get this information from the target devices ROM table.

Syntax

```
CORESIGHT_SetETBBaseAddr = <Addr>
```

Example

```
CORESIGHT_SetETBBaseAddr = 0xE0041000
```

7.13.1.5 CORESIGHT_SetMTBBaseAddr

This command can be used to set the Coresight MTB base address if the debug probe could not get this information from the target devices ROM table.

Syntax

```
CORESIGHT_SetMTBBaseAddr = <Addr>
```

Example

```
CORESIGHT_SetMTBBaseAddr = 0xE0041000
```

7.13.1.6 CORESIGHT_SetETMBaseAddr

This command can be used to set the Coresight ETM base address if the debug probe could not get this information from the target devices ROM table.

Syntax

```
CORESIGHT_SetETMBaseAddr = <Addr>
```

Example

```
CORESIGHT_SetETMBaseAddr = 0xE0041000
```

7.13.1.7 CORESIGHT_SetPTMBaseAddr

This command can be used to set the Coresight PTM base address if the debug probe could not get this information from the target devices ROM table.

Syntax

```
CORESIGHT_SetPTMBaseAddr = <Addr>
```

Example

```
CORESIGHT_SetPTMBaseAddr = 0xE0041000
```

7.13.1.8 CORESIGHT_SetCSTFBaseAddr

This command can be used to set the Coresight TF(Trace Funnel) base address if the debug probe could not get this information from the target devices ROM table.

Syntax

```
CORESIGHT_SetCSTFBaseAddr = <Addr>
```

Example

```
CORESIGHT_SetCSTFBaseAddr = 0xE0041000
```

7.13.1.9 CORESIGHT_SetTMCBaseAddr

This command can be used to set the Coresight TMC base address if the debug probe could not get this information from the target devices ROM table.

Syntax

```
CORESIGHT_SetTMCBaseAddr = <Addr>
```

Example

```
CORESIGHT_SetTMCBaseAddr = 0xE0041000
```

7.13.1.10 CORESIGHT_SetTPIUBaseAddr

This command can be used to set the Coresight TPIU base address if the debug probe could not get this information from the target devices ROM table.

Syntax

```
CORESIGHT_SetTPIUBaseAddr = <Addr>
```

Example

```
CORESIGHT_SetTPIUBaseAddr = 0xE0041000
```

7.13.1.11 device

This command selects the target device.

Syntax

```
device = <DeviceID>
```

DeviceID has to be a valid device identifier. For a list of all available device identifiers, please refer to *Supported devices* .

Example

```
device = AT91SAM7S256
```

7.13.1.12 DisableAutoUpdateFW

This command is used to disable the automatic firmware update if a new firmware is available.

Syntax

```
DisableAutoUpdateFW
```

7.13.1.13 DisableCortexMXPSRAutoCorrectTBit

Usually, the J-Link DLL auto-corrects the T-bit of the XPSR register to 1, for Cortex-M devices. This is because having it set as 0 is an invalid state and would cause several problems during debugging, especially on devices where the erased state of the flash is 0x00 and therefore on empty devices the T-bit in the XPSR would be 0. Anyhow, if for some reason explicit disable of this auto-correction is necessary, this can be achieved via the following J-Link Command String.

Syntax

```
DisableCortexMXPSRAutoCorrectTBit
```

7.13.1.14 DisableFlashBPs

This command disables the FlashBP feature.

Syntax

```
DisableFlashBPs
```

7.13.1.15 DisableFlashDL

This command disables the J-Link FlashDL feature.

Syntax

```
DisableFlashDL
```

7.13.1.16 DisableInfoWinFlashBPs

This command is used to disable the flash download window for the flash breakpoint feature. Enabled by default.

Syntax

```
DisableInfoWinFlashBPs
```

7.13.1.17 DisableInfoWinFlashDL

This command is used to disable the flash download information window for the flash download feature. Enabled by default.

Syntax

```
DisableInfoWinFlashDL
```

7.13.1.18 DisableLowPowerHandlingMode

This command is used to disable low-power handling mode. For further information, please refer to *Activating low power mode handling for J-Link* . Disabled by default.

Syntax

```
DisableLowPowerHandlingMode
```

7.13.1.19 DisableMOEHandling

The J-Link DLL outputs additional information about mode of entry (MOE) in case the target CPU halted / entered debug mode. Disabled by default.

Syntax

```
DisableMOEHandling
```

7.13.1.20 DisablePowerSupplyOnClose

This command is used to ensure that the power supply for the target will be disabled on close.

Syntax

```
DisablePowerSupplyOnClose
```

7.13.1.21 EnableAutoUpdateFW

This command is used to enable the automatic firmware update if a new firmware is available.

Syntax

```
EnableAutoUpdateFW
```

7.13.1.22 EnableEraseAllFlashBanks

Used to enable erasing of other flash banks than the internal, like (Q)SPI flash or CFI flash.

Syntax

```
EnableEraseAllFlashBanks
```

7.13.1.23 EnableFlashBPs

This command enables the FlashBP feature.

Syntax

```
EnableFlashBPs
```

7.13.1.24 EnableFlashDL

This command enables the J-Link ARM FlashDL feature.

Syntax

```
EnableFlashDL
```

7.13.1.25 EnableInfoWinFlashBPs

This command is used to enable the flash download window for the flash breakpoint feature. Enabled by default.

Syntax

```
EnableInfoWinFlashBPs
```

7.13.1.26 EnableInfoWinFlashDL

This command is used to enable the flash download information window for the flash download feature.

Syntax

```
EnableInfoWinFlashDL
```

7.13.1.27 EnableLowPowerHandlingMode

Puts the DLL in low-power handling mode. For further information, please refer to *Activating low power mode handling for J-Link* .

Disabled by default.

Syntax

```
EnableLowPowerHandlingMode
```

7.13.1.28 EnableMOEHandling

The J-Link DLL outputs additional information about mode of entry (MOE) in case the target CPU halted / entered debug mode. Disabled by default. Additional information is output via log-callback set with `JLINK_OpenEx(JLINK_LOG* pfLog, JLINK_LOG* pfErrorOut)`

Syntax

```
EnableMOEHandling
```

7.13.1.29 EnableRemarks

The J-Link DLL provides more detailed output during CPU-detection / connection process. Kind of "verbose" option. Disabled by default, therefore only an enable option. Will be reset to "disabled" on each call to `JLINK_Open()` (reconnect to J-Link).

Syntax

```
EnableRemarks
```

7.13.1.30 ExcludeFlashCacheRange

This command is used to invalidate flash ranges in flash cache, that are configured to be excluded from the cache. Per default, all areas that J-Link knows to be Flash memory, are cached. This means that it is assumed that the contents of this area do not change during program execution. If this assumption does not hold true, typically because the target program modifies the flash content for data storage, then the affected area should be excluded. This will slightly reduce the debugging speed.

Syntax

```
ExcludeFlashCacheRange <Range>
```

Example

```
ExcludeFlashCacheRange 0x10000000-0x100FFFFF
```

7.13.1.31 Hide device selection

This command can be used to suppress the device selection dialog. If enabled, the device selection dialog will not be shown in case an unknown device is selected.

Syntax

```
HideDeviceSelection = 0 | 1
```

Example

```
HideDeviceSelection 1 // Device selection will not show up
```

7.13.1.32 HSSLogFile

This command enables HSS-Logging. Separate to the application using HSS, all HSS Data will be stored in the specified file.

Syntax

```
HSSLogFile = <Path>
```

Example

```
HSSLogFile = C:\Test.log
```

7.13.1.33 InvalidateCache

This command is used to invalidate cache.

Syntax

```
InvalidateCache
```

7.13.1.34 InvalidateFW

This command is used to invalidate the current firmware of the J-Link / J-Trace. Invalidating the firmware will force a firmware update. Can be used for downdating. For more information please refer to *J-Link / J-Trace firmware* .

Syntax

```
InvalidateFW
```

7.13.1.35 map exclude

This command excludes a specified memory region from all memory accesses. All subsequent memory accesses to this memory region are ignored.

Memory mapping

Some devices do not allow access of the entire 4GB memory area. Ideally, the entire memory can be accessed; if a memory access fails, the CPU reports this by switching to abort mode. The CPU memory interface allows halting the CPU via a WAIT signal. On some devices, the WAIT signal stays active when accessing certain unused memory areas. This halts the CPU indefinitely (until RESET) and will therefore end the debug session. This is exactly what happens when accessing critical memory areas. Critical memory areas should not be present in a device; they are typically a hardware design problem. Nevertheless, critical memory areas exist on some devices.

To avoid stalling the debug session, a critical memory area can be excluded from access: J-Link will not try to read or write to critical memory areas and instead ignore the access silently. Some debuggers (such as IAR C-SPY) can try to access memory in such areas by dereferencing non-initialized pointers even if the debugged program (the debuggee) is working perfectly. In situations like this, defining critical memory areas is a good solution.

Syntax

```
map exclude <SAddr>-<EAddr>
```

Example

This is an example for the map exclude command in combination with an NXP LPC2148 MCU.

Memory map

Range	Description
0x00000000-0x0007FFFF	On-chip flash memory
0x00080000-0x3FFFFFFF	Reserved
0x40000000-0x4007FFF	On-chip SRAM
0x40080000-0x7FCFFFFF	Reserved
0x7FD00000-0x7FD01FFF	On-chip USB DMA RAM
0x7FD02000-0x7FD02000	Reserved
0x7FFFD000-0x7FFFFFFF	Boot block (remapped from on-chip flash memory)
0x80000000-0xDFFFFFFF	Reserved
0xE0000000-0xEFFFFFFF	VPB peripherals
0xF0000000-0xFFFFFFFF	AHB peripherals

The “problematic” memory areas are:

Range	Description
0x00080000-0x3FFFFFFF	Reserved
0x40080000-0x7FCFFFFF	Reserved
0x7FD02000-0x7FD02000	Reserved
0x80000000-0xDFFFFFFF	Reserved

To exclude these areas from being accessed through J-Link the map exclude command should be used as follows:

```
map exclude 0x00080000-0x3FFFFFFF
map exclude 0x40080000-0x7FCFFFFF
map exclude 0x7FD02000-0x7FD02000
map exclude 0x80000000-0xDFFFFFFF
```

7.13.1.36 map illegal

This command marks a specified memory region as an illegal memory area. All subsequent memory accesses to this memory region produces a warning message and the memory access is ignored. This command can be used to mark more than one memory region as an illegal area by subsequent calls.

Syntax

Map Illegal <SAddr>-<EAddr>

Example

```
Map Illegal 0xF0000000-0xFFDFFFFFFF
```

Additional information

- SAddr has to be a 256-byte aligned address.

The region size has to be a multiple of 256 bytes.

7.13.1.37 map indirectread

This command can be used to read a memory area indirectly. Indirect reading means that a small code snippet is downloaded into RAM of the target device, which reads and transfers

the data of the specified memory area to the host. Before map indirectread can be called a RAM area for the indirect read code snippet has to be defined. Use therefor the map ram command and define a RAM area with a size of ≥ 256 byte.

Typical applications

Syntax

```
map indirectread <StartAddressOfArea>-<EndAddress>
```

Example

```
map indirectread 0x3fffc000-0x3fffcfff
```

Additional information

- StartAddressOfArea has to be a 256-byte aligned address.

The region size has to be a multiple of 256 bytes.

7.13.1.38 map ram

This command should be used to define an area in RAM of the target device. The area must be 256-byte aligned. The data which was located in the defined area will not be corrupted. Data which resides in the defined RAM area is saved and will be restored if necessary. This command has to be executed before map indirectread will be called.

Typical applications

Syntax

```
map ram <StartAddressOfArea>-<EndAddressOfArea>
```

Example

```
map ram 0x40000000-0x40003fff;
```

Additional information

- StartAddressOfArea has to be a 256-byte aligned address.

The region size has to be a multiple of 256 bytes.

7.13.1.39 map region

This command is used to specify memory areas with various region types.

Syntax

```
map region <StartAddressOfArea>-<EndAddressOfArea> <RegionType>
```

in case of using alias region type:

```
map region <StartAddressOfArea>-<EndAddressOfArea> <RegionType> <StartAliasedAddress> <AliasedAreaSize>
```

Region type	Description
N	Normal
C	Cacheable
X	Excluded
XI	Excluded & Illegal
I	Indirect access
A	Alias (static, e.g. RAM/flash that is aliased multiple times in one area. Does not change during the debug session.)

Region type	Description
AD	Alias (dynamic, e.g. memory areas where different memories can be mapped to.)

Example

```
map region 0x100000-0x1FFFFFF C
map region 0x0-0x1ffff A 0x08000000 0x20000
```

7.13.1.40 map reset

This command restores the default memory mapping, which means all memory accesses are permitted.

Typical applications

Used with other "map" commands to return to the default values. The map reset command should be called before any other "map" command is called.

Syntax

```
map reset
```

Example

```
map reset
```

7.13.1.41 MemPreserveOnReset

This command is used to add a memory preserve area to the internal list of memory areas that need to be preserved before reset and need to be restored after reset. The memory area specified must be readable by the CPU before reset and must be writeable by the CPU immediately after reset. This is mainly used for SRAM debug configurations etc.

Note

Required software version: V6.32 or later

Syntax

```
MemPreserveOnReset <Addr> <Size>[ <Addr> <Size> ...]
```

Example

```
MemPreserveOnReset 0x20000000 0x1000
```

7.13.1.42 ProjectFile

This command is used to specify a file used by the J-Link DLL to save the current configuration.

Using this command is recommended if settings need to be saved. This is typically the case if Flash breakpoints are enabled and used. It is recommended that an IDE uses this command to allow the JLinkARM.dll to store its settings in the same directory as the project and settings file of the IDE. The recommended extension for project files is *.jlink.

Assuming the Project is saved under C:\Work\Work and the project contains targets name Debug and Release, the debug version could set the file name

```
C:\Work\Work\Debug.jlink .
```

The release version could use

```
C:\Work\Work\Release.jlink .
```

Note

Spaces in the filename are permitted.

Syntax

```
ProjectFile = <FullFileName>
```

Example

```
ProjectFile = C:\Work\Release.jlink
```

7.13.1.43 ReadIntoTraceCache

This command is used to read a given memory area into the trace instruction cache. It is mainly used for cases where the download address of the application differs from the execution address. As for trace analysis only cached memory contents are used as memory accesses during trace (especially streaming trace) cause an overhead that is too big, by default trace will only work if execution address is identical to the download address. For other cases, this command can be used to read specific memory areas into the trace instruction cache.

Note

This command causes an immediate read from the target, so it should only be called at a point where memory contents at the given area are known to be valid.

Syntax

```
ReadIntoTraceCache <Addr> <NumBytes>
```

Example

```
ReadIntoTraceCache 0x08000000 0x2000
```

7.13.1.44 RTTtelnetAllowNonLocalClient

This command is used to set allowance for non local telnet clients to access RTT data. Per default this value is 0 and only local connections are accepted. It can be set to 1 to enable non local connections as well.

Note

This command is allowed to be used before `JLINKARM_Open()` was called. This can be achieved using J-Link SDK. For more information visit our website.

Syntax

```
RTTtelnetAllowNonLocalClient = 0 | 1
```

Example

```
RTTtelnetAllowNonLocalClient = 1 // enables non local clients
```

7.13.1.45 ScriptFile

This command is used to set the path to a J-Link script file which shall be executed. J-Link scriptfiles are mainly used to connect to targets which need a special connection sequence before communication with the core is possible.

Syntax

```
ScriptFile = <FullFileName>
```

Example

```
ScriptFile = C:\Work\Default.JLinkScript
```

7.13.1.46 SelectTraceSource

This command selects the trace source which shall be used for tracing.

Note

This is only relevant when tracing on a target that supports trace via pins as well as trace via on-chip trace buffer and a J-Trace (which supports both) is connected to the PC.

Syntax

```
SelectTraceSource = <SourceNumber>
```

Trace source number	Description
0	ETB
1	ETM
2	MTB

Example

```
SelectTraceSource = 0 // Select ETB
```

7.13.1.47 SetAllowStopMode

This command is used to allow / disallow stop mode for RTT and memory accesses. Enabled by default, should only be disabled for testing purposes. For more information about different RTT and memory access modes, please refer to:

[Wiki article RTT modes](#)

[Wiki article memory access modes](#)

Syntax

```
SetAllowStopMode = 0 | 1
```

Example

```
SetAllowStopMode = 0 // Disable usage of stop mode
```

7.13.1.48 SetAllowFlashCache

This command is used to enable / disable caching of flash contents. Enabled by default.

Syntax

```
SetAllowFlashCache = 0 | 1
```

Example

```
SetAllowFlashCache = 1 // Enables flash cache
```

7.13.1.49 SetHostIF

This command can be used to override the host interface. This function should be used used thoughtful and only if you know exactly what you are doing as there are many things which needs to be taken into account. For further information regarding this please refer to *InitEmu()*

Syntax

```
SetHostIF USB = <SerialNumber>  
SetHostIF IP = <IP address>
```

Example

```
SetHostIF USB = 123456           // Connect to J-Link via USB (SN 123456)  
SetHostIF IP = 192.168.0.133    // Connect to J-link with specified IP addr.
```

7.13.1.50 SetAllowSimulation

This command can be used to enable or disable the instruction set simulation. By default the instruction set simulation is enabled.

Syntax

```
SetAllowSimulation = 0 | 1
```

Example

```
SetAllowSimulation 1 // Enables instruction set simulation
```

7.13.1.51 SetBatchMode

This command is used to tell the J-Link DLL that it is used in batch-mode / automatized mode, so some dialogs etc. will automatically close after a given timeout. Disabled by default.

Syntax

```
SetBatchMode = 0 | 1
```

Example

```
SetBatchMode 1 // Enables batch mode
```

7.13.1.52 SetCFIFlash

This command can be used to set a memory area for CFI compliant flashes.

Syntax

```
SetCFIFlash <StartAddressOfArea>-<EndAddressOfArea>
```

Example

```
SetCFIFlash 0x10000000-0x100FFFFFF
```

7.13.1.53 SetCheckModeAfterRead

This command is used to enable or disable the verification of the CPSR (current processor status register) after each read operation. By default this check is enabled. However this can cause problems with some CPUs (e.g. if invalid CPSR values are returned). Please note that if this check is turned off (*SetCheckModeAfterRead* = 0), the success of read operations cannot be verified anymore and possible data aborts are not recognized.

Typical applications

This verification of the CPSR can cause problems with some CPUs (e.g. if invalid CPSR values are returned). Note that if this check is turned off (SetCheckModeAfterRead = 0), the success of read operations cannot be verified anymore and possible data aborts are not recognized.

Syntax

```
SetCheckModeAfterRead = 0 | 1
```

Example

```
SetCheckModeAfterRead = 0
```

7.13.1.54 SetCompareMode

This command is used to configure the compare mode.

Syntax

```
SetCompareMode = <Mode>
```

<Mode>	Description
0	Skip
1	Using fastest method (default)
2	Using CRC
3	Using readback

Example

```
SetCompareMode = 1 // Select using fastest method
```

7.13.1.55 SetCPUConnectIDCODE

Used to specify an IDCODE that is used by J-Link to authenticate itself when connecting to a specific device. Some devices allow the user to lock out a debugger by default, until a specific unlock code is provided that allows further debugging. This function allows to automate this process, if J-Link is used in a production environment.

The IDCODE stream is expected as a hex-encoded byte stream. If the CPU e.g. works on a word-basis for the IDCODE, this stream is interpreted as a little endian formatted stream where the J-Link library then loads the words from and passes them to the device during connect.

Syntax

```
SetCPUConnectIDCODE = <IDCODE_Stream>
```

Example

```
CPU has a 64-bit IDCODE (on word-basis) and expects 0x11223344 0x55667788 as IDCODE.
SetCPUConnectIDCODE = 4433221188776655
```

7.13.1.56 SetDbgPowerDownOnClose

When using this command, the debug unit of the target CPU is powered-down when the debug session is closed.

Note

This command works only for Cortex-M3 devices

Typical applications

This feature is useful to reduce the power consumption of the CPU when no debug session is active.

Syntax

```
SetDbgPowerDownOnClose = <value>
```

Example

```
SetDbgPowerDownOnClose = 1 // Enables debug power-down on close.  
SetDbgPowerDownOnClose = 0 // Disables debug power-down on close.
```

7.13.1.57 SetEnableMemCache

Enables/Disables DLL internal memory cache mechanisms that are used to improve performance. By default, memory cache mechanisms are enabled.

Syntax

```
SetEnableMemCache = 0 | 1
```

Example

```
SetEnableMemCache = 0 // Disable memory caching mechanisms
```

Notes

This command may not be used by any IDE, listed as a supported IDE, to disable memory cache mechanisms by default. It may only be used by specific customers for very specific test cases that needs the cache mechanisms to be disabled.

7.13.1.58 SetETBIsPresent

This command is used to select if the connected device has an ETB.

Syntax

```
SetETBIsPresent = 0 | 1
```

Example

```
SetETBIsPresent = 1 // ETB is available  
SetETBIsPresent = 0 // ETB is not available
```

7.13.1.59 SetETMIsPresent

This command is used to select if the connected device has an ETM.

Syntax

```
SetETMIsPresent = 0 | 1
```

Example

```
SetETMIsPresent = 1 // ETM is available  
SetETMIsPresent = 0 // ETM is not available
```

7.13.1.60 SetFlashDLNoRMWThreshold

This command sets the J-Link DLL internal threshold when a write to flash memory does not cause a read-modify-write (RMW) operation. For example, when setting this value to `0x800`, all writes of amounts of data < 2 KB will cause the DLL to perform a read-modify-write operation on incomplete sectors.

Default: Writing amounts of < 1 KB (`0x400`) to flash causes J-Link to perform a read-modify-write on the flash.

Example 1 with default config

- Flash has 2 * 1 KB sectors
- Debugger writes 512 bytes

J-Link will perform a read-modify-write on the first sector, preserving contents of 512 - 1023 bytes. Second sector is left untouched.

Example 2 with default config

- Flash has 2 * 1 KB sectors
- Debugger writes 1280 bytes

J-Link will erase + program 1 KB of first sector.

J-Link will erase + program 256 bytes of second sector.

Previous 768 bytes from second sector are lost.

The default makes sense for flash programming where old contents in remaining space of affected sectors are usually not needed anymore. Writes of < 1 KB usually mean that the user is performing flash manipulation from within a memory window in a debugger to manipulate the application behavior during runtime (e.g. by writing some constant data used by the application). In such cases, it is important to preserve the remaining data in the sector to allow the application to further work correctly.

Syntax

```
SetFlashDLNoRMWThreshold = <value>
```

Example

```
SetFlashDLNoRMWThreshold = 0x100 // 256 Bytes
```

7.13.1.61 SetFlashDLThreshold

This command is used to set a minimum amount of data to be downloaded by the flash download feature.

Syntax

```
SetFlashDLThreshold = <value>
```

Example

```
SetFlashDLThreshold = 0x100 // 256 Bytes
```

7.13.1.62 SetIgnoreReadMemErrors

This command can be used to ignore read memory errors. Disabled by default.

Syntax

```
SetIgnoreReadMemErrors = 0 | 1
```

Example

```
SetIgnoreReadMemErrors = 1 // Read memory errors will be ignored
SetIgnoreReadMemErrors = 0 // Read memory errors will be reported
```

7.13.1.63 SetIgnoreWriteMemErrors

This command can be used to ignore read memory errors. Disabled by default.

Syntax

```
SetIgnoreWriteMemErrors = 0 | 1
```

Example

```
SetIgnoreWriteMemErrors = 1 // Write memory errors will be ignored
SetIgnoreWriteMemErrors = 0 // Write memory errors will be reported
```

7.13.1.64 SetMonModeDebug

This command is used to enable / disable monitor mode debugging. Disabled by default.

Syntax

```
SetMonModeDebug = 0 | 1
```

Example

```
SetMonModeDebug = 1 // Monitor mode debugging is enabled
SetMonModeDebug = 0 // Monitor mode debugging is disabled
```

7.13.1.65 TraceSampleAdjust

Allows to adjust the sample point for the specified trace data signals inside the J-Trace firmware. This can be useful to compensate certain delays on the target hardware (e.g. caused by routing etc.).

Syntax

```
TraceSampleAdjust <PinName> = <Adjust_Ps>[ <PinName#<Adjust_Ps> ...]
```

<PinName>	Description
TD	Adjust all trace data signals
TD0	Adjust trace data 0
TD1	Adjust trace data 1
TD2	Adjust trace data 2
TD3	Adjust trace data 3
TD3..0	Adjust trace data 0-3
TD2..1	Adjust trace data 1-2
TDx..y	Adjust trace data x-y

<Adjust_Ps>	Description
-5000 to 5000	Adjustment in [ps]

Example

```
TraceSampleAdjust TD = 1000
```

7.13.1.66 SetResetPulseLen

This command defines the length of the RESET pulse in milliseconds. The default for the RESET pulse length is 20 milliseconds.

Syntax

```
SetResetPulseLen = <value>
```

Example

```
SetResetPulseLen = 50
```

7.13.1.67 SetResetType

This command selects the reset strategy which shall be used by J-Link, to reset the device. The value which is used for this command is analog to the reset type which shall be selected. For a list of all reset types which are available, please refer to *Reset strategies*. Please note that there different reset strategies for ARM 7/9 and Cortex-M devices.

Syntax

```
SetResetType = <value>
```

Example

```
SetResetType = 0 // Selects reset strategy type 0: normal
```

7.13.1.68 SetRestartOnClose

This command specifies whether the J-Link restarts target execution on close. The default is to restart target execution. This can be disabled by using this command.

Syntax

```
SetRestartOnClose = 0 | 1
```

Example

```
SetRestartOnClose = 1
```

7.13.1.69 SetRTTAddr

In some cases J-Link cannot locate the RTT buffer in known RAM. This command is used to set the exact address manually.

Syntax

```
SetRTTAddr <RangeStart>
```

Example

```
SetRTTAddr 0x20000000
```

7.13.1.70 SetRTTTelnetPort

This command alters the RTT telnet port. Default is 19021. This command must be called before a connection to a J-Link is established. In J-Link Commander, J-Link Command Strings ("exec <JLinkCommandString>") can only be executed after a connection to J-Link is established, therefore this command string has no effect in J-Link Commander. The *-RTTTelnetPort* command line parameter can be used instead.

Syntax

```
SetRTTTelnetPort <value>
```

Example

```
SetRTTTelnetPort 9100
```

7.13.1.71 SetRTTSearchRanges

In some cases J-Link cannot locate the RTT buffer in known RAM. This command is used to set (multiple) ranges to be searched for the RTT buffer.

Syntax

```
SetRTTSearchRanges <RangeAddr> <RangeSize> [, <RangeAddr1> <RangeSize1>, ..]
```

Example

```
SetRTTSearchRanges 0x10000000 0x1000, 0x20000000 0x1000,
```

7.13.1.72 SetRXIDCode

This command is used to set the ID Code for Renesas RX devices to be used by the J-Link DLL.

Syntax

```
SetRXIDCode = <RXIDCode_String>
```

Example

Set 16 IDCode Bytes (32 Characters).

```
SetRXIDCode = 112233445566778899AABBCCDDEEFF00
```

7.13.1.73 SetSkipProgOnCRCMatch

Note

Deprecated. Use [SetCompareMode](#) instead.

This command is used to configure the CRC match / compare mode.

Syntax

```
SetSkipProgOnCRCMatch = <CompareMode>
```

Compare mode	Description
0	Skip
1	Using fastest method (default)
2	Using CRC
3	Using readback

Example

```
SetSkipProgOnCRCMatch = 1 // Select using fastest method
```

7.13.1.74 SetSysPowerDownOnIdle

When using this command, the target CPU is powered-down when no transmission between J-Link and the target CPU was performed for a specific time. When the next command is given, the CPU is powered-up.

Note

This command works only for Cortex-M3 devices.

Typical applications

This feature is useful to reduce the power consumption of the CPU.

Syntax

```
SetSysPowerDownOnIdle = <value>
```

Note

A 0 for <value> disables the power-down on idle functionality.

Example

```
SetSysPowerDownOnIdle = 10; // The target CPU is powered-down when there is no
                             // transmission between J-Link and target CPU for
                             // at least 10ms
```

7.13.1.75 SetVerifyDownload

This command is used to configure the verify mode.

Syntax

```
SetVerifyDownload = <VerifyMode>
```

Compare mode	Description
0	Skip
1	Programmed sectors, fastest method (default)
2	Programmed sectors using CRC
3	Programmed sectors using readback
4	All sectors using fastest method
5	All sectors using CRC
6	All sectors using read back
7	Programmed sectors using checksum
8	All sectors using checksum

Example

```
SetVerifyDownload = 1 // Select programmed sectors, fastest method
```

7.13.1.76 SetWorkRAM

This command can be used to configure the RAM area which will be used by J-Link.

Syntax

```
SetWorkRAM <StartAddressOfArea>-<EndAddressOfArea>
```

Example

```
SetWorkRAM 0x10000000-0x100FFFFFF
```

7.13.1.77 ShowControlPanel

Executing this command opens the control panel.

Syntax

```
ShowControlPanel
```

7.13.1.78 SilentUpdateFW

After using this command, new firmware will be updated automatically without opening a message box.

Syntax

```
SilentUpdateFW
```

7.13.1.79 SupplyPower

This command activates power supply over pin 19 of the JTAG connector. The KS (Kickstart) versions of J-Link have the V5 supply over pin 19 activated by default.

Typical applications

This feature is useful for some eval boards that can be powered over the JTAG connector.

Syntax

```
SupplyPower = 0 | 1
```

Example

```
SupplyPower = 1
```

7.13.1.80 SupplyPowerDefault

This command activates power supply over pin 19 of the JTAG connector permanently. The KS (Kickstart) versions of J-Link have the V5 supply over pin 19 activated by default.

Typical applications

This feature is useful for some eval boards that can be powered over the JTAG connector.

Syntax

```
SupplyPowerDefault = 0 | 1
```

Example

```
SupplyPowerDefault = 1
```

7.13.1.81 SuppressControlPanel

Using this command ensures, that the control panel will not pop up automatically.

Syntax

```
SuppressControlPanel
```

7.13.1.82 SuppressInfoUpdateFW

After using this command information about available firmware updates will be suppressed.

Note

We strongly recommend not to use this command, latest firmware versions should always be used!

Syntax

```
SuppressInfoUpdateFW
```

7.13.1.83 SWOSetConversionMode

This command is used to set the SWO conversion mode.

Syntax

```
SWOSetConversionMode = <ConversionMode>
```

Conversion mode	Description
0	If only '\n' is received, make it "\\r\n" to make the line end Windows-compliant. (Default behavior)
1	Leave everything as it is, do not add any characters.

Example

```
SWOSetConversionMode = 0
```

7.13.2 Using J-Link Command Strings

For instructions on how to execute J-Link script files depending on the debug environment used, please refer to: [SEGGER Wiki: Using J-Link Command Strings](#)

7.14 Switching off CPU clock during debug

We recommend not to switch off CPU clock during debug. However, if you do, you should consider the following:

Non-synthesizable cores (ARM7TDMI, ARM9TDMI, ARM920, etc.)

With these cores, the TAP controller uses the clock signal provided by the emulator, which means the TAP controller and ICE-Breaker continue to be accessible even if the CPU has no clock.

Therefore, switching off CPU clock during debug is normally possible if the CPU clock is periodically (typically using a regular timer interrupt) switched on every few ms for at least a few us. In this case, the CPU will stop at the first instruction in the ISR (typically at address 0x18).

Synthesizable cores (ARM7TDMI-S, ARM9E-S, etc.)

With these cores, the clock input of the TAP controller is connected to the output of a three-stage synchronizer, which is fed by clock signal provided by the emulator, which means that the TAP controller and ICE-Breaker are not accessible if the CPU has no clock.

If the RTCK signal is provided, adaptive clocking function can be used to synchronize the JTAG clock (provided by the emulator) to the processor clock. This way, the JTAG clock is stopped if the CPU clock is switched off.

If adaptive clocking is used, switching off CPU clock during debug is normally possible if the CPU clock is periodically (typically using a regular timer interrupt) switched on every few ms for at least a few us. In this case, the CPU will stop at the first instruction in the ISR (typically at address 0x18).

7.15 Cache handling

Most target systems with external memory have at least one cache. Typically, ARM7 systems with external memory come with a unified cache, which is used for both code and data. Most ARM9 systems with external memory come with separate caches for the instruction bus (I-Cache) and data bus (D-Cache) due to the hardware architecture.

7.15.1 Cache coherency

When debugging or otherwise working with a system with processor with cache, it is important to maintain the cache(s) and main memory coherent. This is easy in systems with a unified cache and becomes increasingly difficult in systems with hardware architecture. A write buffer and a D-Cache configured in write-back mode can further complicate the problem.

ARM9 chips have no hardware to keep the caches coherent, so that this is the responsibility of the software.

7.15.2 Cache clean area

J-Link / J-Trace handles cache cleaning directly through JTAG commands. Unlike other emulators, it does not have to download code to the target system. This makes setting up J-Link / J-Trace easier. Therefore, a cache clean area is not required.

7.15.3 Cache handling of ARM7 cores

Because ARM7 cores have a unified cache, there is no need to handle the caches during debug

7.15.4 Cache handling of ARM9 cores

ARM9 cores with cache require J-Link / J-Trace to handle the caches during debug. If the processor enters debug state with caches enabled, J-Link / J-Trace does the following:

When entering debug state

J-Link / J-Trace performs the following:

- It stores the current write behavior for the D-Cache.
- It selects write-through behavior for the D-Cache.

When leaving debug state

J-Link / J-Trace performs the following:

- It restores the stored write behavior for the D-Cache.
- It invalidates the D-Cache.

Note

The implementation of the cache handling is different for different cores. However, the cache is handled correctly for all supported ARM9 cores.

7.16 Virtual COM Port (VCOM)

7.16.1 Configuring Virtual COM Port

In general, the VCOM feature can be disabled and enabled for debug probes which comes with support for it via J-Link Commander and J-Link Configurator. Below, a small description of how to use use them to configure the feature is given.

Note

VCOM can only be used when debugging via SWD target interface. Pin 5 = J-Link-Tx (out), Pin 17 = J-Link-Rx (in).

Note

Currently, only J-Link models with hardware version 9 or newer comes with VCOM capabilities.

7.16.1.1 Via J-Link Configurator

The J-Link Software and Documentation Package comes with a free GUI-based utility called J-Link Configurator which auto-detects all J-Links that are connected to the host PC via USB & Ethernet. The J-Link Configurator allows the user to enable and disable the VCOM. For more information about the J-Link Configurator, please refer to *J-Link Configurator* .

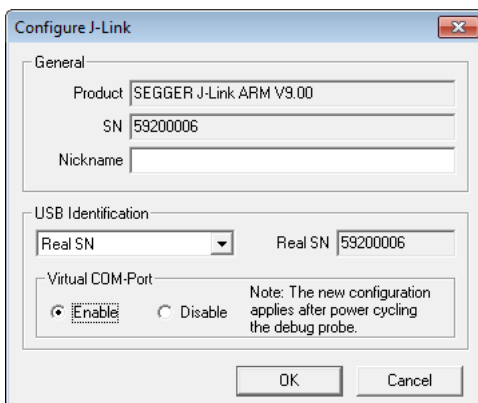

7.16.1.2 Via J-Link Commander

Simply start J-Link Commander, which is part of the J-Link Software and Documentation Package and enter the `vcom enable|disable` command as in the screenshot below. After changing the configuration a power on cycle of the debug probe is necessary in order to use the new configuration. For feature information about how to use the J-Link Commander, please refer to *J-Link Commander (Command line tool)* .

```
C:\WINDOWS\system32\cmd.exe - jlink
C:\Program Files (x86)\SEGGER\JLink_V614h>jlink
SEGGER J-Link Commander V6.14h (Compiled May 10 2017 18:23:19)
DLL version V6.14h, compiled May 10 2017 18:22:45

Connecting to J-Link via USB...O.K.
Firmware: J-Link Pro V4 compiled Apr 21 2017 11:15:52
Hardware version: V4.00
S/N: 174402383
License(s): RDI, FlashBP, FlashDL, JFlash, GDB
IP-Addr: DHCP (no addr. received yet)
VTref = 3.300V

Type "connect" to establish a target connection, '?' for help
J-Link>vcom enable
The new configuration applies after power cycling the debug probe.
J-Link>
```

Chapter 8

Flash download

This chapter describes how the flash download feature of the DLL can be used in different debugger environments.

8.1 Introduction

The J-Link DLL comes with a lot of flash loaders that allow direct programming of internal flash memory for popular microcontrollers. Moreover, the J-Link DLL also allows programming of CFI-compliant external NOR flash memory. The flash download feature of the J-Link DLL does not require an extra license and can be used free of charge.

Why should I use the J-Link flash download feature?

Being able to download code directly into flash from the debugger or integrated IDE significantly shortens the turn-around times when testing software. The flash download feature of J-Link is very efficient and allows fast flash programming. For example, if a debugger splits the download image into several pieces, the flash download software will collect the individual parts and perform the actual flash programming right before program execution. This avoids repeated flash programming. Moreover, the J-Link flash loaders make flash behave like RAM. This means that the debugger only needs to select the correct device which enables the J-Link DLL to automatically activate the correct flash loader if the debugger writes to a specific memory address.

This also makes it very easy for debugger vendors to make use of the flash download feature because almost no extra work is necessary on the debugger side since the debugger does not have to differ between memory writes to RAM and memory writes to flash.

8.2 Licensing

No extra license required. The flash download feature can be used free of charge.

8.3 Supported devices

J-Link supports download into the internal flash of a large number of microcontrollers. You can always find the latest list of supported devices on our website:

[*List of supported target devices*](#)

In general, J-Link can be used with any ARM7/ARM9/ARM11, Cortex-M0/M1/M3/M4/M7/M23/M33, Cortex-A5/A7/A8/A9/A12/A15/A17 and Cortex-R4/R5 core even if it does not provide internal flash.

Furthermore, flash download is also available for all CFI-compliant external NOR-flash devices.

8.4 Setup for various debuggers (internal flash)

The J-Link flash download feature can be used by different debuggers, such as IAR Embedded Workbench, Keil MDK, GDB based IDEs, For different debuggers there are different steps required to enable J-Link flash download.

Most debuggers will use the J-Link flashloader by default if the target device is specified. A few debuggers come with their own flashloaders and need to be configured to use the J-Link flashloader in order to achieve the maximum possible performance.

For further information on how to specify the target device and on how to use the J-Link flashloader in different debuggers, please refer to:

[SEGGER Wiki: Getting Started with Various IDEs](#)

Note

While using flashloaders of a 3rd party applications works in most cases, SEGGER can neither offer support for those nor guarantee that other features won't be impaired as a side effect of not using the J-Link flashloader

8.5 Setup for various debuggers (CFI flash)

The setup for download into CFI-compliant memory is different from the one for internal flash. Initialization of the external memory interface the CFI flash is connected to, is user's responsibility and is expected by the J-Link software to be done prior to performing accesses to the specified CFI area.

Specifying of the CFI area is done in a J-Link script file, as explained below.

For further information on J-Link script files, please refer to *J-Link Script Files* and for further information on how to use J-Link script files with different debuggers, please refer to: [SEGGER Wiki: Getting Started with Various IDEs](#) .

8.6 Setup for various debuggers (SPIFI flash)

The J-Link DLL supports programming of SPIFI flash and the J-Link flash download feature can be used therefore by different debuggers, such as IAR Embedded Work bench, Keil MDK, GDB based IDEs, ...

There is nothing special to be done by the user to also enable download into SPIFI flash. The setup and behavior is the same as if download into internal flash. For more information about how to setup different debuggers for downloading into SPIFI flash memory, please refer to *Setup for various debuggers (internal flash)* on page 252.

8.7 QSPI flash support

The J-Link DLL also supports programming of any (Q)SPI flash connected to a device that is supported by the J-Link DLL, if the device allows memory-mapped access to the flash. Most modern MCUs / CPUs provide a so called "QSPI area" in their memory-map which allows the CPU to read-access a (Q)SPI flash as regular memory (RAM, internal flash etc.).

8.7.1 Setup the DLL for QSPI flash download

There is nothing special to be done by the user to also enable download into a QSPI flash connected to a specific device. The setup and behavior is the same as if download into internal flash, which mainly means the device has to be selected and nothing else, would be performed. For more information about how to setup the J-Link DLL for download into internal flash memory, please refer to *Setup for various debuggers (internal flash)* on page 252.

The sectorization, command set and other flash parameters are fully auto-detected by the J-Link DLL, so no special user setup is required.

8.8 Using the DLL flash loaders in custom applications

The J-Link DLL flash loaders make flash behave as RAM from a user perspective, since flash programming is triggered by simply calling the J-Link API functions for memory reading / writing. For more information about how to setup the J-Link API for flash programming please refer to the J-Link SDK documentation (UM08002) (available for *J-Link SDK* customers only).

8.9 Debugging applications that change flash contents at runtime

The J-Link DLL caches flash contents in order to improve overall performance and therefore provide the best debugging experience possible. In case the debugged application does change the flash contents, it is necessary to disable caching of the effected flash range. This can be done using the J-Link command string *ExcludeFlashCacheRange* .

The SEGGER Wiki provides an article about this topic that provides further information, which can be found here:

[*SEGGER Wiki: Debugging self-modifying code in flash*](#)

Chapter 9

Flash breakpoints

This chapter describes how the flash breakpoints feature of the DLL can be used in different debugger environments.

9.1 Introduction

The J-Link DLL supports a feature called flash breakpoints which allows the user to set an unlimited number of breakpoints in flash memory rather than only being able to use the hardware breakpoints of the device. Usually when using hardware breakpoints only, a maximum of 2 (ARM 7/9/11) to 8 (Cortex-A/R) breakpoints can be set. The flash memory can be the internal flash memory of a supported microcontroller or external CFI-compliant flash memory. In the following sections the setup for different debuggers for use of the flash breakpoints feature is explained.

How do breakpoints work?

There are basically 2 types of breakpoints in a computer system: Hardware breakpoints and software breakpoints. Hardware breakpoints require a dedicated hardware unit for every breakpoint. In other words, the hardware dictates how many hardware breakpoints can be set simultaneously. ARM 7/9 cores have 2 breakpoint units (called "watchpoint units" in ARM's documentation), allowing 2 hardware breakpoints to be set. Hardware breakpoints do not require modification of the program code. Software breakpoints are different: The debugger modifies the program and replaces the breakpointed instruction with a special value. Additional software breakpoints do not require additional hardware units in the processor, since simply more instructions are replaced. This is a standard procedure that most debuggers are capable of, however, this usually requires the program to be located in RAM.

What is special about software breakpoints in flash?

Flash breakpoints allows setting an unlimited number of breakpoints even if the user application is not located in RAM. On modern microcontrollers this is the standard scenario because on most microcontrollers the internal RAM is not big enough to hold the complete application. When replacing instructions in flash memory this requires re-programming of the flash which takes much more time than simply replacing a instruction when debugging in RAM. The J-Link flash breakpoints feature is highly optimized for fast flash programming speed and in combination with the instruction set simulation only re-programs flash that is absolutely necessary. This makes debugging in flash using flash breakpoints almost as flawless as debugging in RAM.

What performance can I expect?

Flash algorithm, specially designed for this purpose, sets and clears flash breakpoints extremely fast; on microcontrollers with fast flash the difference between software breakpoints in RAM and flash is hardly noticeable.

How is this performance achieved?

We have put a lot of effort in making flash breakpoints really usable and convenient. Flash sectors are programmed only when necessary; this is usually the moment execution of the target program is started. A lot of times, more than one breakpoint is located in the same flash sector, which allows programming multiple breakpoints by programming just a single sector. The contents of program memory are cached, avoiding time consuming reading of the flash sectors. A smart combination of software and hardware breakpoints allows us to use hardware breakpoints a lot of times, especially when the debugger is source level-stepping, avoiding re-programming the flash in these situations. A built-in instruction set simulator further reduces the number of flash operations which need to be performed. This minimizes delays for the user, while maximizing the life time of the flash. All resources of the ARM microcontroller are available to the application program, no memory is lost for debugging.

9.2 Licensing

In order to use the flash breakpoints feature a separate license is necessary for each J-Link. For some devices J-Link comes with a device-based license and some J-Link models also come with a full license for flash breakpoints but the normal J-Link comes without any licenses. For more information about licensing itself and which devices have a device-based license, please refer to *J-Link Model overview* .

9.2.1 Free for evaluation and non-commercial use

In general, the unlimited flash breakpoints feature of the J-Link DLL can be used free of charge for evaluation and non-commercial use. If used in a commercial project, a license needs to be purchased when the evaluation is complete. There is no time limit on the evaluation period. This feature allows setting an unlimited number of breakpoints even if the application program is located in flash memory, thereby utilizing the debugging environment to its fullest.

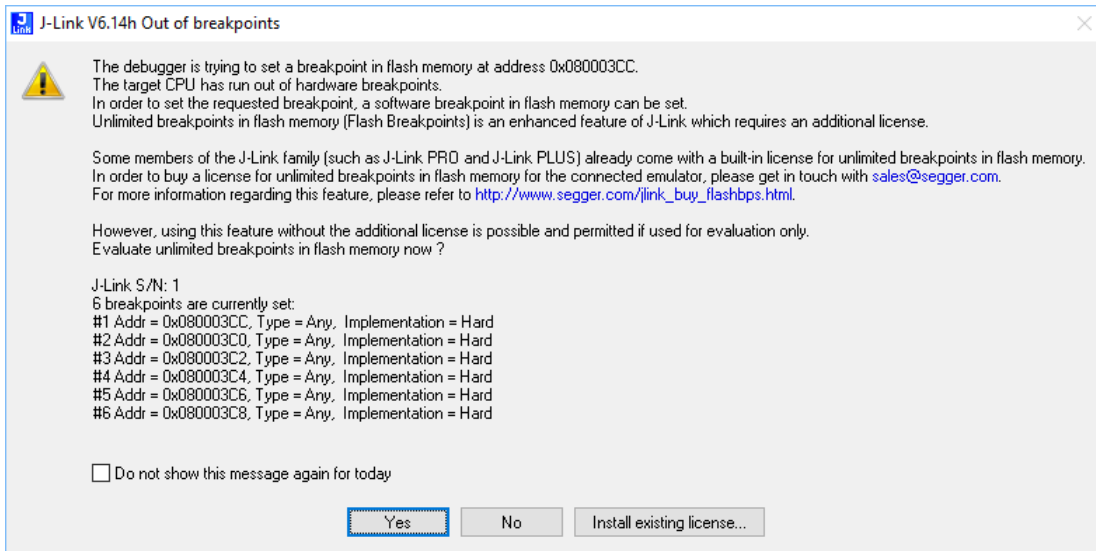

9.3 Supported devices

J-Link supports flash breakpoints for a large number of microcontrollers. You can always find the latest list of supported devices on our website:

[*List of supported target devices*](#)

In general, J-Link can be used with any ARM7/ARM9/ARM11, Cortex-M0/M1/M3/M4/M7/M23/M33, Cortex-A5/A7/A8/A9/A12/A15/A17 and Cortex-R4/R5 core even if it does not provide internal flash.

Furthermore, flash breakpoints are also available for all CFI compliant external NOR-flash devices.

9.4 Setup & compatibility with various debuggers

9.4.1 Setup

In compatible debuggers, flash breakpoints work if the J-Link flash loader works and a license for flash breakpoints is present. No additional setup is required. The flash breakpoint feature is available for internal flashes and for external flash (parallel NOR CFI flash as well as QSPI flash). For more information about how to setup various debuggers for flash download, please refer to *Setup for various debuggers (internal flash)* . Whether flash breakpoints are available can be verified using the J-Link control panel:

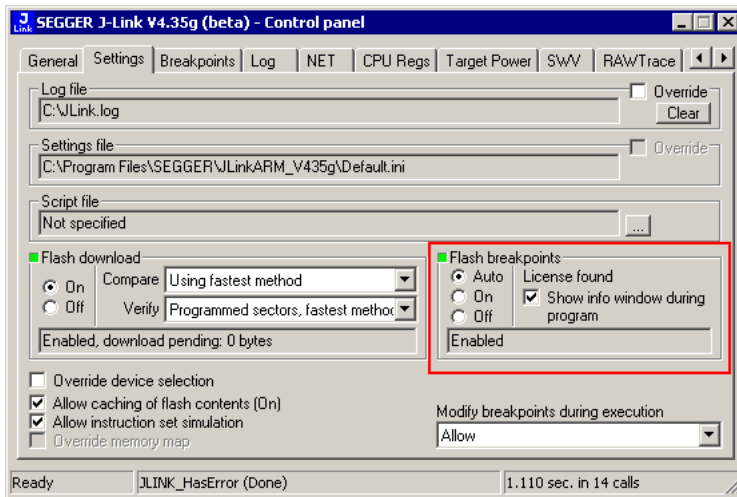

9.4.2 Compatibility with various debuggers

Flash breakpoints can be used in all debugger which use the proper J-Link API to set breakpoints. Compatible debuggers/ debug interfaces are:

- IAR Embedded Workbench
- Keil MDK
- GDB-based debuggers
- Freescale Codewarrior
- Mentor Graphics Sourcery CodeBench
- RDI-compliant debuggers

Incompatible debuggers / debug interfaces:

- Rowley Crossworks

9.5 Flash Breakpoints in QSPI flash

Many modern CPUs allow direct execution from QSPI flash in a so-called “QSPI area” in their memory-map. This feature is called execute-in-place (XIP). On some cores like Cortex-M where hardware breakpoints are only available in a certain address range, sometimes J-Link flash breakpoints are the only possibility to set breakpoints when debugging code running in QSPI flash.

9.5.1 Setup

The setup for the debugger is the same as for downloading into QSPI flash. For more information please refer to *QSPI flash support* .

9.6 FAQ

Why can flash breakpoints not be used with Rowley Crossworks? Because Rowley Crossworks does not use the proper J-Link API to set breakpoints. Instead of using the breakpoint-API, Crossworks programs the debug hardware directly, leaving J-Link no choice to use its flash breakpoints.

Chapter 10

Monitor Mode Debugging

This chapter describes how to use monitor mode debugging support with J-Link.

10.1 Introduction

In general, there are two standard debug modes available for CPUs:

1. Halt mode
2. Monitor mode

Halt mode is the default debug mode used by J-Link. In this mode the CPU is halted and stops program execution when a breakpoint is hit or the debugger issues a halt request. This means that no parts of the application continue running while the CPU is halted (in debug mode) and peripheral interrupts can only become pending but not taken as this would require execution of the debug interrupt handlers. In circumstances halt mode may cause problems during debugging specific systems:

1. Certain parts of the application need to keep running in order to make sure that communication with external components does not break down. This is the case for Bluetooth applications where the Bluetooth link needs to be kept up while the CPU is in debug mode, otherwise the communication would fail and a resume or single stepping of the user application would not be possible
2. Some peripherals are also stopped when the CPU enters debug mode. For example; Pulse-width modulation (PWM) units for motor control applications may be halted while in an undefined / or even dangerous state, resulting in unwanted side-effects on the external hardware connected to these units.

This is where monitor mode debugging becomes effective. In monitor debug mode the CPU is not halted but takes a specific debug exception and jumps into a defined exception handler that executes (usually in a loop) a debug monitor software that performs communication with J-Link (in order to read/write CPU registers and so on). The main effect is the same as for halting mode: the user application is interrupted at a specific point but in contrast to halting mode, the fact that the CPU executes a handler also allows it to perform some specific operations on debug entry / exit or even periodically during debug mode with almost no delay. This enables the handling of such complex debug cases as those explained above.

10.2 Enable Monitor Debugging

As explained before, by default J-Link uses halt mode debugging. In order to enable monitor mode debugging, the J-Link software needs to be explicitly told to use monitor mode debugging. This is done slightly differently from IDE to IDE. In general, the IDE does not notice any difference between halting and monitor debug mode. If J-Link is unable to locate a valid monitor in the target memory, it will default back to halt mode debugging in order to still allow debugging in general.

For instructions on how to enable Monitor Mode Debugging, please refer to:
[SEGGER Wiki: Enable Monitor Mode Debugging](#)

10.3 Availability and limitations of monitor mode

Many CPUs only support one of these debug modes, halt mode or monitor mode. In the following it is explained for which CPU cores monitor mode is available and any limitations, if any.

10.3.1 Cortex-M3

See *Cortex-M4* on page 268.

10.3.2 Cortex-M4

For Cortex-M4, monitor mode debugging is supported. The monitor code provided by SEGGER can easily be linked into the user application.

Considerations & Limitations

The user-specific monitor functions must not block the generic monitor for more than 100ms. Manipulation of the stack pointer register (SP) from within the IDE is not possible as the stack pointer is necessary for resuming the user application on Go(). The unlimited number of flash breakpoints feature cannot be used in monitor mode. This restriction may be removed in a future version. It is not possible to debug the monitor itself, when using monitor mode.

10.4 Monitor code

A CPU core-specific monitor code is necessary to perform monitor mode debugging with J-Link. This monitor performs the communication with J-Link while the CPU is in debug mode (meaning in the monitor exception). The monitor code needs to be compiled and linked as a normal part of the application. Monitors for different cores are available from SEGGER upon request at support_jlink@segger.com.

In general, the monitor code consists of three files:

- `JLINK_MONITOR.c`: Contains user-specific functions that are called on debug mode entry, exit and periodically while the CPU is in debug mode. Functions can be filled with user-specific code. None of the functions must block the generic monitor for more than 100ms.
- `JLINK_MONITOR.h`: Header file to populate `JLINK_MONITOR_` functions.
- `JLINK_MONITOR_ISR.s`: Generic monitor assembler file. (Should not be modified by the user) Do NOT touch.

10.5 Debugging interrupts

In general it is possible to debug interrupts when using monitor mode debugging but there are some things that need to be taken care of when debugging interrupts in monitor mode:

- Only interrupts with a lower priority than the debug/monitor interrupt can be debugged / stepped.
- Setting breakpoints in interrupt service routines (ISRs) with higher priority than the debug/monitor interrupt will result in malfunction because the CPU cannot take the debug interrupt when hitting the breakpoint.

10.6 Having servicing interrupts in debug mode

Under some circumstances it may be useful or even necessary to have some servicing interrupts still firing while the CPU is “halted” for the debugger (meaning it has taken the debug interrupt and is executing the monitor code). This can be for keeping motor controls active or a Bluetooth link etc. In general it is possible to have such interrupts by just assigning a higher priority to them than the debug interrupt has. Please keep in mind that there are some limitations for such interrupts:

- They cannot be debugged
- No breakpoints must be set in any code used by these interrupts

10.7 Forwarding of Monitor Interrupts

In some applications, there might be an additional software layer that takes all interrupts in the first place and forwards them to the user application by explicitly calling the ISRs from the user application vector table. For such cases, it is impossible for J-Link to automatically check for the existence of a monitor mode handler as the handler is usually linked in the user application and not in the additional software layer, so the DLL will automatically switch back to halt mode debugging. In order to enable monitor mode debugging for such cases, the base address of the vector table of the user application that includes the actual monitor handler needs to be manually specified. For more information about how to do this for various IDEs, please refer to *Enable Monitor Debugging* .

10.8 Target application performs reset (Cortex-M)

For Cortex-M based target CPUs if the target application contains some code that issues a reset (e.g. a watchdog reset), some special care needs to be taken regarding breakpoints. In general, a target reset will leave the debug logic of the CPU untouched meaning that breakpoints etc. are left intact, however monitor mode gets disabled (bits in DEMCR get cleared). J-Link automatically restores the monitor bits within a few microseconds, after they have been detected as being cleared without explicitly being cleared by J-Link.

However, there is a small window in which it can happen that a breakpoint is hit before J-Link has restored the monitor bits. If this happens, instead of entering debug mode, a HardFault is triggered. To avoid hanging of the application, a special version of the HardFault_Handler is needed which detects if the reason for the HardFault was a breakpoint and if so, just ignores it and resumes execution of the target application. A sample for such a HardFault handler can be downloaded from the SEGGER website: <https://www.segger.com/downloads/apnotes> "Generic SEGGER HardFault handler".

Chapter 11

Low Power Debugging

This chapter describes how to debug low power modes on a supported target CPU.

11.1 Introduction

As power consumption is an important factor for embedded systems, CPUs provide different kinds of low power modes to reduce power consumption of the target system. The usefulness of this for the application, the problematic it is during debug. In general, how far debugging target applications that make use of low power modes is possible, heavily depends on the device being used as several behaviors are implementation defined and differ from device to device. The following cases are the most common ones:

1. The device provides specific special function registers for debugging to keep some clocks running necessary for debugging, while the device is in a low power mode.
2. The device wakes up automatically, as soon as there is a request by the debug probe on the debug interface
3. The device powers off the debug interface partially, allowing the debug probe to read-access certain parts but does not allow to control the CPU.
4. The device powers off the debug interface completely and the debug probe loses the connection to the device (temporarily)

While cases 1-3 are the most convenient ones from the debug perspective because the low power mode is transparent to the end user, they do not provide a real-world scenario because certain things cannot be really tested if certain clocks are still active which would not be in the release configuration with no debug probe attached. In addition to that, the power consumption is significantly higher than in the release config which may cause problems on some hardware designs which are specifically designed for very low power consumption.

The last case (debug probe temporarily loses connection) usually causes the end of a debug session because the debugger would get errors on accesses like "check if CPU is halted/hit a BP". To avoid this, there is a special setting for J-Link that can be activated, to handle such cases in a better way, which is explained in the following.

11.2 Activating low power mode handling for J-Link

While usually the J-Link DLL handles communication losses as errors, there is a possibility to enable low power mode handling in the J-Link DLL, which puts the DLL into a less restrictive mode (low-power handling mode) when it comes to such loss-cases. The low-power handling mode is disabled by default to allow the DLL to react on target communication breakdowns but this behavior is not desired when debugging cases where the target is unresponsive temporarily. How the low-power mode handling mode is enabled, depends on the debug environment.

Please refer to [SEGGER Wiki: Low power mode handling](#) for instructions on how to enable low power mode handling.

11.3 Restrictions

As the connection to the target is temporary lost while it is in low power mode, some restrictions during debug apply:

- Make sure that the IDE does not perform periodic accesses to memory while the target is in a low power mode. E.g.: Disable periodic refresh of memory windows, close live watch windows etc.
- Avoid issuing manual halt requests to the target while it is in a low power mode.
- Do not try to set breakpoints while the target already is in a low power mode. If a breakpoint in a wake-up routine shall be hit as soon as the target wakes up from low power mode, set this breakpoint before the target enters low power mode.
- Single stepping instructions that enter a low power mode (e.g. WFI/WFE on Cortex-M) is not possible/supported.
- Debugging low power modes that require a reset to wake-up can only be debugged on targets where the debug interface is not reset by such a reset. Otherwise breakpoints and other settings are lost which may result in unpredictable behavior.

J-Link does it's best to handle cases where one or more of the above restrictions is not considered but depending on how the IDE reacts to specific operations to fail, error messages may appear or the debug session will be terminated by the IDE.

Chapter 12

Open Flashloader

This chapter describes how to add support for new devices to the J-Link DLL and software that uses the J-Link DLL using the Open Flashloader concept.

12.1 Introduction

As the number of devices being available is steadily growing and sometimes in an early stage of the MCU development only a few samples/boards are available that may not be provided to third parties (e.g. SEGGER) to add support for a new device. Also the existence of the device may have confidential status, so it might not be mentioned as being supported in public releases yet. Therefore it might be desirable to be able to add support for new devices on your own, without depending on SEGGER and a new release of the J-Link software package being available.

The J-Link DLL allows customers to add support for new devices on their own. It is also possible to edit/extend existing devices of the device database by for example adding new flash banks (e.g. to add support for internal EEPROM programming or SPIFI programming etc.). This chapter explains how new devices can be added to the DLL and how existing ones can be edited/extended.

12.2 General procedure

By default, the J-Link DLL comes with a build-in device database that defines which device names are known and therefore officially supported by the J-Link DLL and software that uses the J-Link DLL. This list can also be viewed on our website:

[List of supported target devices](#)

It is possible to add new devices to the currently used DLL by specifying them in an XML file, named JLinkDevices.xml . It is also possible to edit/extend an device from the built-in device database via this XML file. The DLL is looking for this file in the same directory where the J-Link settings file is located. The location of the settings file depends on the IDE / software being used. For more information about where the settings file is located for various IDEs and software that use the J-Link DLL, please refer to [SEGGER Wiki: Getting Started with Various IDEs](#) .

12.3 Adding a new device

In order to add support for a new device to the J-Link DLL, the following needs to be added to the JLinkDevices.xml :

```
<Database>
  <Device>
    <ChipInfo Vendor="..."
              Name="..."
              WorkRAMAddr="..."
              WorkRAMSize="..."
              Core="..." />
    <FlashBankInfo Name="..."
                   BaseAddr="..."
                   MaxSize="..."
                   Loader="..."
                   LoaderType="..."
                   AlwaysPresent="..." />
  </Device>
</Database>
```

When adding a new device, the following attributes for the `<ChipInfo>` tag are mandatory:

- Vendor
- Name
- Core

In case a `<FlashBankInfo>` tag is also added, the following attributes in addition to the ones mentioned before, become mandatory:

ChipInfo-Tag

- WorkRAMAddr
- WorkRAMSize
- FlashBankInfo

FlashBankInfo-Tag

- Name
- BaseAddr
- MaxSize
- Loader
- LoaderType
- AlwaysPresent

For more information about the tags and their attributes, please refer to *XML Tags and Attributes* .

In order to add more than one device to the device database, just repeat the `<Device>` ... `</Device>` tag structure from above for each device.

12.4 Editing/Extending an Existing Device

In order to edit/extend a device that is already in the built-in device database of the J-Link DLL, the following needs to be added to the JLinkDevices.xml :

```
<Database>
  <Device>
    <ChipInfo Vendor="..."
              Name="..." />
    <FlashBankInfo Name="..."
                   BaseAddr="..."
                   MaxSize="..."
                   Loader="..."
                   LoaderType="..."
                   AlwaysPresent="..." />
  </Device>
</Database>
```

The attribute Name of the tag <ChipInfo> must specify exactly the same name as the device in the built-in device database specifies. In case the value of the attribute BaseAddr specifies an address of an existing flash bank for the existing device, in the built-in device database, the flash bank from the built-in database is replaced by the one from the XML file.

When adding new flash banks or if the device in the built-in database does not specify any flash banks so far, the same attribute requirements as for adding a new device, apply. For more information, please refer to *Adding a new device* .

In order to add more than one flash bank, just repeat the <FlashBankInfo ... />> tag structure from above, inside the same <Device> tag.

For more information about the tags and their attributes, please refer to *XML Tags and Attributes* .

12.5 XML Tags and Attributes

In the following, the valid XML tags and their possible attributes are explained.

General rules

- Attributes may only occur inside an opening tag
- Attribute values must be enclosed by quotation marks

Tag	Description
<Database>	Opens the XML file top-level tag.
<Device>	Opens the description for a new device.
<ChipInfo>	Specifies basic information about the device to be added, like the core it incorporates etc.
<FlashBankInfo>	Specifies a flash bank for the device.

12.5.1 <Database>

Opens the XML file top-level tag. Only present once per XML file.

Valid attributes

This tag has no attributes

Notes

- Must only occur once per XML file
- Must be closed via </Database>

12.5.2 <Device>

Opens the description for a new device.

Valid attributes

This tag has no attributes

Notes

- Must be closed via </Device> .
- May occur multiple times in an XML file

12.5.3 <ChipInfo>

Specifies basic information about the device to be added, like the core it incorporates etc.

Valid attributes

Parameter	Meaning
Vendor	String that specifies the name of the vendor of the device. This attribute is mandatory. E.g. Vendor="ST".
Name	Name of the device. This attribute is mandatory. E.g. Name="STM32F407IE"
WorkRAMAddr	Hexadecimal value that specifies the address of a RAM area that can be used by J-Link during flash programming etc. Should not be used by any DMAs on the device. Cannot exist without also specifying WorkRAMSize. If no flash banks are added for the new device, this attribute is optional. E.g. WorkRAMAddr="0x20000000"

Parameter	Meaning
WorkRAMSize	Hexadecimal value that specifies the size of the RAM area that can be used by J-Link during flash programming etc. Cannot exist without also specifying WorkRAMAddr . If no flash banks are added for the new device, this attribute is optional. E.g. WorkRAMSize="0x10000"
Core	Specifies the core that the device incorporates. If a new device added, this attribute is mandatory. E.g. Core="JLINK_CORE_CORTEX_M0" For a list of valid attribute values, please refer to <i>Attribute values - Core</i> .
JLinkScriptFile	String that specifies the path to a J-Link script file if required for the device. Path can be relative or absolute. If path is relative, is relative to the location of the JLinkDevices.xml file. This attribute is mandatory. E.g. JLinkScriptFile="ST/Example.jlinkscript"
Aliases	String that is a list of aliases for the specified device. Every alias creates an entry in the target device list with the alias as device name. The different aliases are separated by semicolons (";"). E.g. Aliases="Device_1;Device_2;Device_3;Device_4"

Notes

- No separate closing tag.
Directly closed after attributes have been specified: <ChipInfo ... />
- Must not occur outside a <Device> tag.

12.5.3.1 Attribute values - Core

The following values are valid for the [Core](#) attribute:

- JLINK_CORE_CORTEX_M1
- JLINK_CORE_CORTEX_M3
- JLINK_CORE_CORTEX_M3_R1P0
- JLINK_CORE_CORTEX_M3_R1P1
- JLINK_CORE_CORTEX_M3_R2P0
- JLINK_CORE_CORTEX_M3_R2P1
- JLINK_CORE_CORTEX_M0
- JLINK_CORE_CORTEX_M_V8BASEL
- JLINK_CORE_ARM7
- JLINK_CORE_ARM7TDMI
- JLINK_CORE_ARM7TDMI_R3
- JLINK_CORE_ARM7TDMI_R4
- JLINK_CORE_ARM7TDMI_S
- JLINK_CORE_ARM7TDMI_S_R3
- JLINK_CORE_ARM7TDMI_S_R4
- JLINK_CORE_CORTEX_A8
- JLINK_CORE_CORTEX_A7
- JLINK_CORE_CORTEX_A9
- JLINK_CORE_CORTEX_A12
- JLINK_CORE_CORTEX_A15
- JLINK_CORE_CORTEX_A17
- JLINK_CORE_ARM9
- JLINK_CORE_ARM9TDMI_S
- JLINK_CORE_ARM920T
- JLINK_CORE_ARM922T
- JLINK_CORE_ARM926EJ_S
- JLINK_CORE_ARM946E_S
- JLINK_CORE_ARM966E_S

- JLINK_CORE_ARM968E_S
- JLINK_CORE_ARM11
- JLINK_CORE_ARM1136
- JLINK_CORE_ARM1136J
- JLINK_CORE_ARM1136J_S
- JLINK_CORE_ARM1136JF
- JLINK_CORE_ARM1136JF_S
- JLINK_CORE_ARM1156
- JLINK_CORE_ARM1176
- JLINK_CORE_ARM1176J
- JLINK_CORE_ARM1176J_S
- JLINK_CORE_ARM1176JF
- JLINK_CORE_ARM1176JF_S
- JLINK_CORE_CORTEX_R4
- JLINK_CORE_CORTEX_R5
- JLINK_CORE_RX
- JLINK_CORE_RX62N
- JLINK_CORE_RX62T
- JLINK_CORE_RX63N
- JLINK_CORE_RX630
- JLINK_CORE_RX63T
- JLINK_CORE_RX621
- JLINK_CORE_RX62G
- JLINK_CORE_RX631
- JLINK_CORE_RX65N
- JLINK_CORE_RX21A
- JLINK_CORE_RX220
- JLINK_CORE_RX230
- JLINK_CORE_RX231
- JLINK_CORE_RX23T
- JLINK_CORE_RX24T
- JLINK_CORE_RX110
- JLINK_CORE_RX113
- JLINK_CORE_RX130
- JLINK_CORE_RX71M
- JLINK_CORE_CORTEX_M4
- JLINK_CORE_CORTEX_M7
- JLINK_CORE_CORTEX_M_V8MAINL
- JLINK_CORE_CORTEX_A5
- JLINK_CORE_POWER_PC
- JLINK_CORE_POWER_PC_N1
- JLINK_CORE_POWER_PC_N2
- JLINK_CORE_MIPS
- JLINK_CORE_MIPS_M4K
- JLINK_CORE_MIPS_MICROAPTIV
- JLINK_CORE_EFM8_UNSPEC
- JLINK_CORE_CIP51

12.5.4 <FlashBankInfo>

Specifies a flash bank for the device. This allows to use the J-Link flash download functionality with IDEs, debuggers and other software that uses the J-Link DLL (e.g. J-Link Commander) for this device. The flash bank can then be programmed via the normal flash download functionality of the J-Link DLL. For more information about flash download, please refer to *Flash download* . For possible limitations etc. regarding newly added flash banks, please refer to *Add. Info / Considerations / Limitations* .

Valid attributes

Parameter	Meaning
Name	String that specifies the name of the flash bank. Only used for visualization. Can be freely chosen. This attribute is mandatory. E.g. Name="SPIFI flash"
BaseAddr	Hexadecimal value that specifies the start address of the flash bank. The J-Link DLL uses this attribute together with MaxSize to determine which memory write accesses performed by the debugger, shall be redirected to the flash loader instead of being written directly to the target as normal memory access. This attribute is mandatory. E.g. BaseAddr="0x08000000"
MaxSize	Hexadecimal value that specifies the max. size of the flash bank in bytes. For many flash loader types the real bank size may depend on the actual flash being connected (e.g. SPIFI flash where the loader can handle different SPIFI flashes so size may differ from hardware to hardware). Also, for some flash loaders the sectorization is extracted from the flash loader at runtime. The real size of the flash bank may be smaller than MaxSize but must never be bigger. The J-Link DLL uses this attribute together with BaseAddr to determine which memory write accesses performed by the debugger, shall be redirected to the flash loader instead of being written directly to the target as normal memory access. This attribute is mandatory. E.g. MaxSize="0x80000"
Loader	String that specifies path to the ELF file that holds the flash loader. Path can be relative or absolute. If path is relative, it is relative to the location of the JLinkDevices.xml file. This attribute is mandatory. E.g. Loader="ST/MyFlashLoader.elf" For CMSIS flash loaders the file extension is usually FLM, however any extension is accepted by the J-Link DLL.
LoaderType	Specifies the type of the loader specified by Loader . This attribute is mandatory. E.g. LoaderType="FLASH_ALGO_TYPE_OPEN" For a list of valid attribute values, please refer to <i>Attribute values LoaderType</i> .
AlwaysPresent	Specifies if a flash bank is always present (e.g. internal flash). If this element is set to one, this flash bank will be affected by the "erase" command. This attribute is optional. E.g. AlwaysPresent="1".

Notes

- No separate closing tag. Directly closed after attributes have been specified: `<FlashBankInfo ... />`
- Must not occur outside a `<Device>` tag

12.5.4.1 Attribute values - LoaderType

The following values are valid for the [LoaderType](#) attribute:

- FLASH_ALGO_TYPE_OPEN
Describes that the used algorithm is an Open Flashloader algorithm. CMSIS based algorithms are also supported via the Open Flashloader concept. For additional information, see *Add. Info / Considerations / Limitations* .

12.6 Example XML file

```

<Database>
  <Device>
    <ChipInfo Vendor="Vendor0"
      Name="Device0"
      WorkRAMAddr="0x20000000"
      WorkRAMSize="0x4000"
      Core="JLINK_CORE_CORTEX_M0" />
    <FlashBankInfo Name="Int. Flash"
      BaseAddr="0x0"
      MaxSize="0x10000"
      Loader="Vendor0/Loader0.FLM"
      LoaderType="FLASH_ALGO_TYPE_OPEN" />
    <FlashBankInfo Name="SPIFI Flash"
      BaseAddr="0x30000000"
      MaxSize="0x100000"
      Loader="Vendor0/Loader1.FLM"
      LoaderType="FLASH_ALGO_TYPE_OPEN" />
  </Device>
  <Device>
    <ChipInfo Vendor="Vendor1"
      Name="Device1"
      WorkRAMAddr="0x20000000"
      WorkRAMSize="0x4000"
      JLinkScriptFile="Vendor1/Device1.jlinkscript"
      Core="JLINK_CORE_CORTEX_M0" />
    <FlashBankInfo Name="Int. Flash"
      BaseAddr="0x70000000"
      MaxSize="0x10000"
      Loader="Vendor1/Loader0.FLM"
      LoaderType="FLASH_ALGO_TYPE_OPEN" />
  </Device>
  <Device>
    <ChipInfo Vendor="ST"
      Name="STM32F746NGH6" />
    <FlashBankInfo Name="SPIFI Flash"
      BaseAddr="0x30000000"
      MaxSize="0x80000"
      Loader="ST/STM32F7xx_SPIFI.FLM"
      LoaderType="FLASH_ALGO_TYPE_OPEN" />
  </Device>
</Database>

```

12.7 Add. Info / Considerations / Limitations

Note

SEGGER does not give any guarantee for correct functionality nor provide any support for customized devices / flash banks. Using J-Link support for customized devices that have been added via a XML device description file is done at user's own risk.

In the following, some considerations / limitations when adding support for a new device or editing/extending an existing device, are given:

12.7.1 CMSIS Flash Algorithms Compatibility

CMSIS flash algorithms are also supported by the Open Flashloader concept. Therefore, an existing *.FLM file can be simply referenced in a J-Link XML device description file. The `LoaderType` attribute needs to be set to `FLASH_ALGO_TYPE_OPEN` .

12.7.2 Supported Cores

Currently, the Open Flashloader supports the following cores:

- Cortex-M
- Cortex-A
- Cortex-R

12.7.3 Information for Silicon Vendors

SEGGER offers the opportunity to hand in custom created flash algorithms which will then be included in the official J-Link Software and Documentation Package hence distributed to any J-Link customer who is using the latest software package.

The following files need to be provided to SEGGER:

- JLinkDevices.xml - including the device entry / entries
- Flash loader file - referenced in the JLinkDevices.xml (source code is optional)
- Readme.txt which may includes additional information or at least a contact e-mail address which can be used by customers in case support is needed.

12.7.4 Template Projects and How To's

SEGGER provides template projects for Cortex-M as well as Cortex-A/R based on the SEGGER Embedded Studio IDE plus an detailed step-by-step instruction and further information are provided on a separate SEGGER wiki page: [SEGGER Wiki: Adding Support for New Devices](#)

Chapter 13

J-Flash SPI

This chapter describes J-Flash SPI and J-Flash SPI CL, which are separate software (executables) which allow direct programming of SPI flashes, without any additional hardware. Both, J-Flash SPI and J-Flash SPI CL are part of the J-Link Software and Documentation Package which is available free of charge. This chapter assumes that you already possess working knowledge of the J-Link device.

13.1 Introduction

The following chapter introduces J-Flash SPI, highlights some of its features, and lists its requirements on host and target systems.

13.1.1 What is J-Flash SPI?

J-Flash SPI is a stand-alone flash programming software for PCs running Microsoft Windows, which allows direct programming of SPI flashes, without any additional hardware. J-Flash SPI has an intuitive user interface and makes programming flash devices convenient. J-Flash SPI requires a J-Link or Flasher to interface to the hardware. It is able to program all kinds of SPI flashes, even if the CPU they are connected to, is not supported by J-Link / Flasher because J-Flash SPI communicates directly with the SPI flash bypassing all other components of the hardware.

13.1.1.1 Supported OS

The following Microsoft Windows versions are supported by J-Flash SPI:

- Microsoft Windows 2000
- Microsoft Windows XP
- Microsoft Windows XP x64
- Microsoft Windows 2003
- Microsoft Windows 2003 x64
- Microsoft Windows Vista
- Microsoft Windows Vista x64
- Microsoft Windows 7
- Microsoft Windows 7 x64
- Microsoft Windows 8
- Microsoft Windows 8 x64
- Microsoft Windows 10
- Microsoft Windows 10 x64

13.1.2 J-Flash SPI CL (Windows, Linux, Mac)

J-Flash SPI CL is a commandline-only version of the J-Flash SPI programming tool. The command line version is included in the J-Link Software and Documentation Package for Windows, Linux and Mac (cross-platform). Except from the missing GUI, J-Flash SPI CL is identical to the normal version. The commands, used to configure / control J-Flash SPI CL, are exactly the same as for the command line interface of the J-Flash SPI GUI version. For further information, please refer to *Command Line Interface* on page 303.

13.1.2.1 Supported OS

The following operating systems are supported by J-Flash CL:

- Microsoft Windows 2000
- Microsoft Windows XP
- Microsoft Windows XP x64
- Microsoft Windows 2003
- Microsoft Windows 2003 x64
- Microsoft Windows Vista
- Microsoft Windows Vista x64
- Microsoft Windows 7
- Microsoft Windows 7 x64
- Microsoft Windows 8
- Microsoft Windows 8 x64
- Microsoft Windows 10
- Microsoft Windows 10 x64
- Linux
- macOS 10.5 and higher

13.1.3 Features

- Directly communicates with the SPI flash via SPI protocol, no MCU in between needed.
- Programming of all kinds of SPI flashes is supported.
- Can also program SPI flashes that are connected to CPUs that are not supported by J-Link.
- Supports any kind of custom command sequences (e.g. write protection register)
- Verbose logging of all communication.
- .hex, .mot, .srec, and .bin support.
- Intuitive user interface.

13.1.4 Requirements

13.1.4.1 Host

J-Flash SPI requires a PC running one of the supported operating system (see above) with a free USB port dedicated to a J-Link. A network connection is required only if you want to use J-Flash SPI together with J-Link Remote Server.

13.1.4.2 Target

The flash device must be an SPI flash that supports standard SPI protocols.

13.2 Licensing

The following chapter provides an overview of J-Flash SPI related licensing options.

13.2.1 Introduction

A J-Link PLUS, ULTRA+, PRO or Flasher ARM/PRO is required to use J-Flash SPI. No additional license is required / available.

13.3 Getting Started

This chapter presents an introduction to J-Flash SPI. It provides an overview of the included sample projects and describes the menu structure of J-Flash SPI in detail.

13.3.1 Setup

For J-Link setup procedure required in order to work with J-Flash SPI, please refer to chapter *Setup* on page 139.

13.3.1.1 What is included?

Tons of defines. The following table shows the contents of all subdirectories of the J-Link Software and Documentation Pack with regard to J-Flash SPI:

Directory	Contents
.	The J-Flash SPI application. Please refer to the J-Link Manual (UM08001) for more information about the other J-Link related tools.
.\Doc	Contains the J-Flash SPI documentation (part of J-Link Manual (UM08001)) and the other J-Link related manuals.
.\Samples\JFlashSPI \ProjectFiles	Contains sample projects for J-Flash SPI.

13.3.2 Using J-Flash SPI for the first time

Start J-Flash SPI from the Windows Start menu. The main window will appear, which contains a log window at the bottom and the **Project window** of a default project on the left. The application log will initially display:

- The version and time of compilation for the application.
- The version and time of compilation for the J-Link DLL.
- The location of the default project.

The Project window contains an overview of the current project settings (initially, a default project is opened).

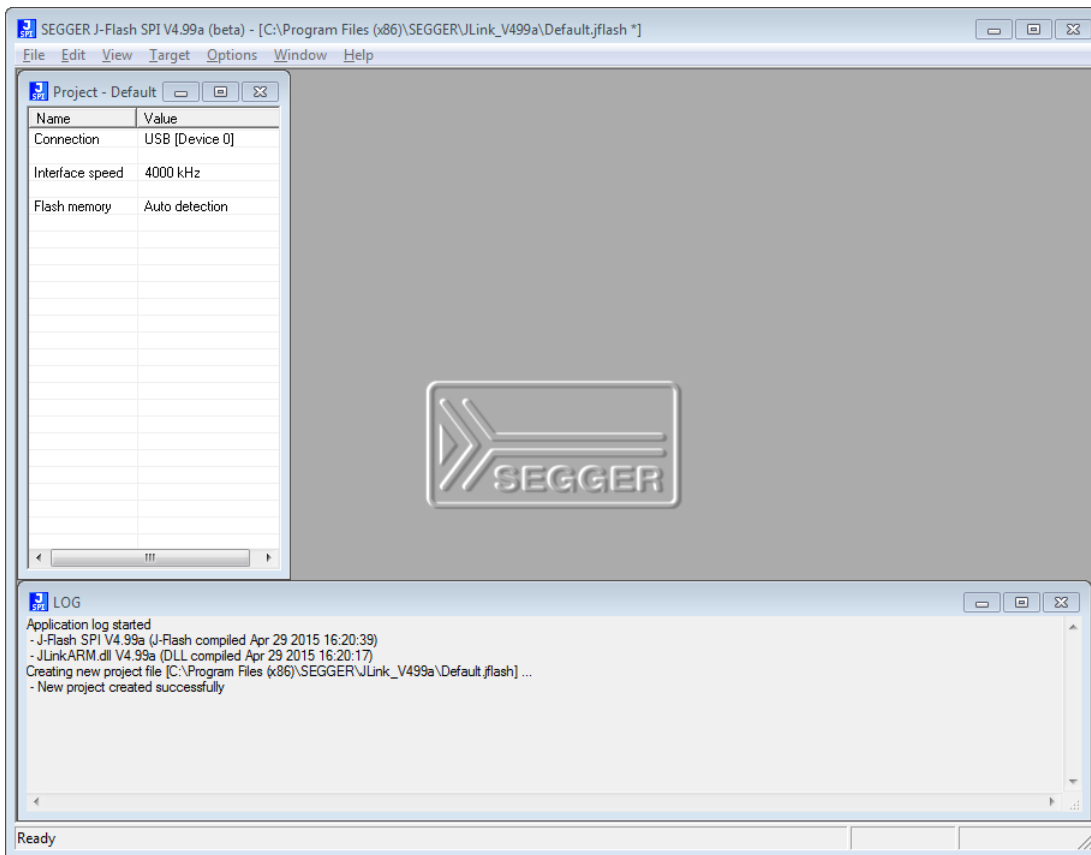

13.3.3 Menu structure

The main window of J-Flash SPI contains seven drop-down menus (**File, Edit, View, Target, Options, Window, Help**). Any option within these drop-down menus that is followed by a three period ellipsis (...), is an option that requires more information before proceeding.

File menu elements

Command	Description
Open data file...	Opens a data file that may be used to flash the target device. The data file must be an Intel HEX file, a Motorola S file, or a Binary file (.hex, .mot, .srec, or .bin).
Merge data file	Merges two data files (.hex, .mot, .srec, or .bin). All gaps will be filled with FF. Find below a short example of merging two data files named, File0.bin and File1.bin into File3.bin. File0.bin -> Addr 0x0200 - 0x02FF File1.bin -> Addr 0x1000 - 0x13FF Merge File0.bin & File1.bin 0x0200 - 0x02FF Data of File0.bin 0x0300 - 0x0FFF gap (will be filled with 0xFF if image is saved as *.bin file) 0x1000 - 0x13FF Data of File1.bin Can be saved in new data file (File3.bin).
Save data file	Saves the data file that currently has focus.
Save data file as...	Saves the data file that currently has focus using the name and location given.
New Project	Creates a new project using the default settings.

Command	Description
Open Project...	Opens a project file. Note that only one project file may be open at a time. Opening a project will close any other project currently open.
Save Project	Saves a project file.
Save Project as...	Saves a project file using the name and location given.
Close Project	Closes a project file.
Recent Files >	Contains a list of the most recently open data files.
Recent Projects >	Contains a list of the most recently open project files.
Exit Exits	Exits the application.

Edit menu elements

Command...	Description
Relocate...	Relocates the start of the data file to the supplied hex offset from the current start location.
Delete range...	Deletes a range of values from the data file, starting and ending at given addresses. The End address must be greater than the Start address otherwise nothing will be done.
Eliminate blank areas...	Eliminates blank regions within the data file.

View menu elements

Command	Description
Log	Opens and/or sets the focus to the log window.
Project	Opens and/or sets the focus to the project window.

Target menu elements

Command	Description
Connect	Creates a connection through the J-Link using the configuration options set in the Project settings... of the Options dropdown menu.
Disconnect	Disconnects a current connection that has been made through the J-Link.
Test > Generate test data	Generates data which can be used to test if the flash can be programmed correctly. The size of the generated data file can be defined.
Erase Sectors	Erases all selected flash sectors.
Erase Chip	Erases the entire chip.
Program	Programs the chip using the currently active data file.
Program & Verify	Programs the chip using the currently active data file and then verifies that it was written successfully.
Auto	Performs a sequence of steps, which can be configured in the Production tab of the Project settings. Additionally, the first step executed are the init steps and the last step executed are the exit steps, which both can be configured in the MCU tab of the project settings. The range of sectors to be erased can be configured through the Global settings dialog.

Command	Description
Verify	Verifies the data found on the chip with the data file.
Read back > Entire chip	Reads back the data found on the chip and creates a new data file to store this information.
Read back > Range	Reads back the data found in a range specified by the user and creates a new data file to store this information.

Options menu elements

Command	Description
Project settings...	Location of the project settings that are displayed in the snapshot view found in the Project window of the J-Flash SPI application. Furthermore various settings needed to locate the J-Link and pass specified commands needed for chip initialization.
Global settings...	Settings that influence the general operation of J-Flash SPI.

Window menu elements

Command	Description
Cascade	Arranges all open windows, one above the other, with the active window at the top
Tile Horizontal	Tiles the windows horizontally with the active window at the top.
Tile Vertical	Tiles the windows vertically with the active window at the left.
<List of currently open windows>	A entry of the list can be selected to move the focus to the respective window.

Help menu elements

Command	Description
J-Link User Guide	Opens the J-Link Manual (UM08001) in the default .PDF application of the system.
About...	J-Flash SPI and company information.

13.4 Settings

The following chapter provides an overview of the program settings. Both general and per project settings are considered.

13.4.1 Project Settings

Project settings are available from the Options menu in the main window or by using the ALT-F7 keyboard shortcut.

13.4.1.1 General Settings

This dialog is used to choose the connection to J-Link. The J-Link can either be connected over USB or via TCP/IP to the host system. Refer to the J-Link Manual (UM08001) for more information regarding the operation of J-Link and J-Link Remote Server.

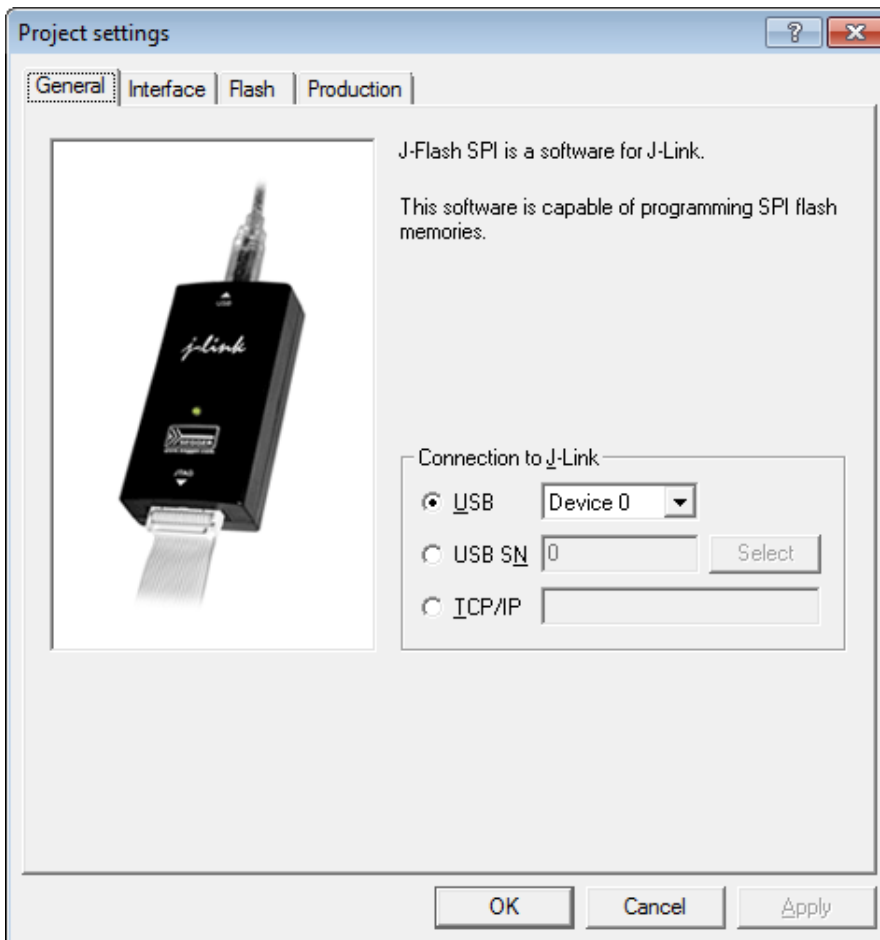

USB

If this option is checked, J-Flash SPI will connect to J-Link over the USB port. You may change the device number if you want to connect more than one J-Link to your PC. The default device number is 0. For more information about how to use multiple J-Links on one PC, please see also the chapter “Working with J-Link” of the J-Link Manual (UM08001).

TCP/IP

If this option is selected, J-Flash SPI will connect to J-Link via J-Link Remote Server. You have to specify the hostname of the remote system running the J-Link Remote Server.

13.4.1.2 Setup

This dialog is used to configure the SPI interface settings like SPI communication speed and allows to add Init steps and Exit steps which can be used to execute custom command sequences.

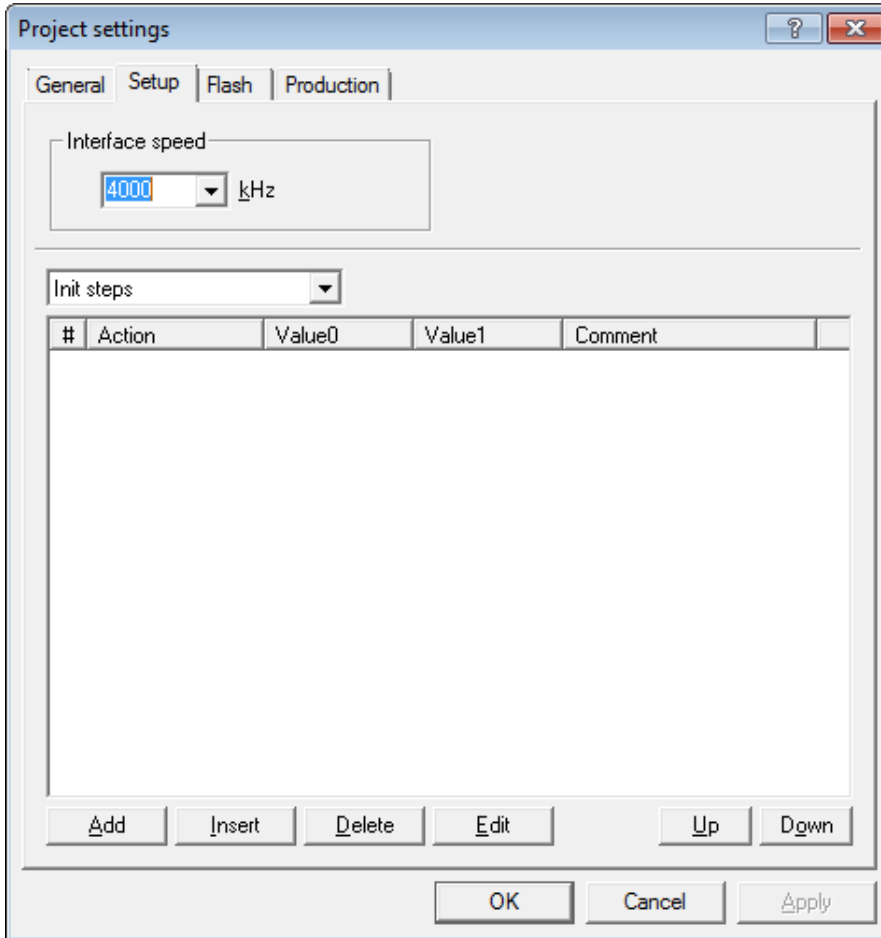

Interface Speed

Specifies the SPI communication speed J-Link uses to communicate with the SPI flash.

Init and Exit steps

Can be used to add custom command sequences like for example write protection register. For further information regarding this, please refer to *Custom Command Sequences* on page 309.

13.4.1.3 Flash Settings

This dialog is used to select and configure the parameters of the SPI flash that J-Flash SPI will connect to. Examples for flash parameters are: Sector size (Smallest erasable unit), page size (smallest programmable unit), Flash ID, etc. There is also the option to try to auto-detect the connected flash device. The latter option will prompt J-Flash SPI to try to identify the flash by its Flash ID, looking up in an internal list of known flash devices.

Project settings

General | Setup | Flash | Production

Automatically detect SPI flash

General Settings

Flash ID

NumPages PageSize

NumAddrBytes SectorSize

Control Instructions

WriteEnable ReadStatus ReadID

WriteDisable WriteStatus

Dedicated 4-byte addr. mode

Enter instruction

Exit instruction

Status Register

Ready Bit Busy Bit Bit Pos.

Programming Instructions

EraseSector WritePage

EraseBulk ReadData

13.4.1.4 Production Settings

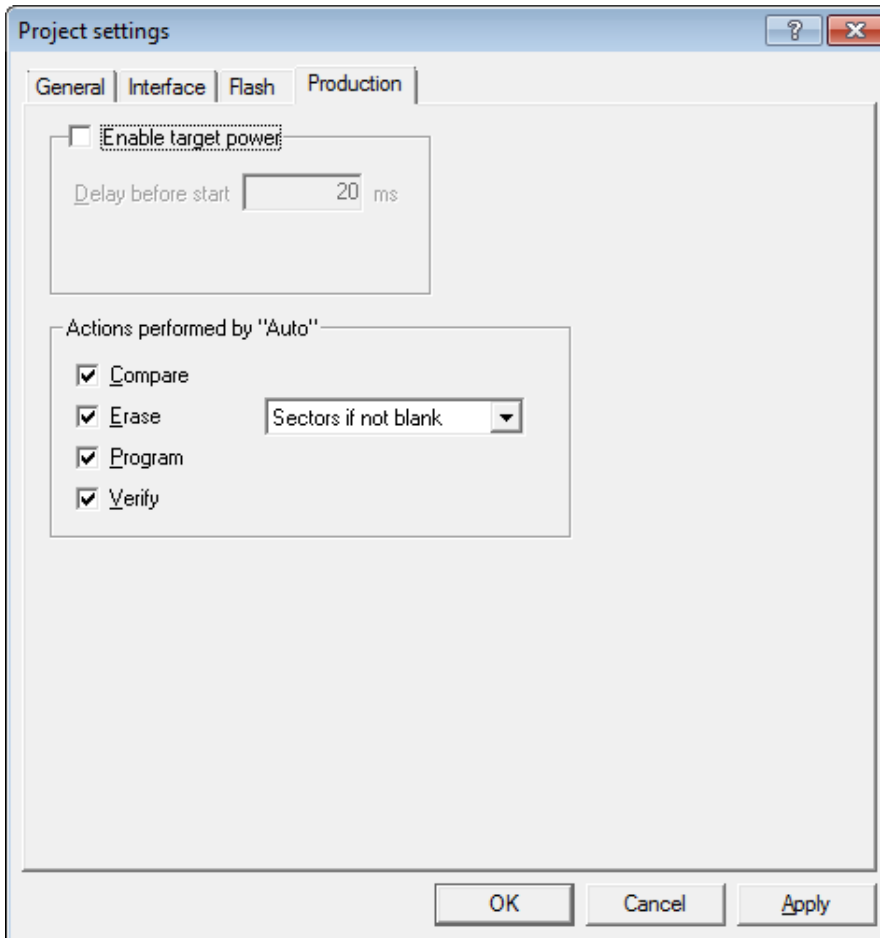

Enable target power

Enables 5V target power supply via pin 19 of the emulator. Can be used for targets which can be powered through the emulator for production. Delay before start defines the delay (in ms) after enabling the target power supply and before starting to communicate with the target.

Actions performed by "Auto"

The checked options will be performed when auto programming a target (Target -> Auto, shortcut: F7). The default behavior is Compare, Erase sectors if not blank, Program and Verify. Find below a table which describes the commands:

Command	Description
Compare	Performs a compare of the current flash content and the data to be programmed. Sectors which do already match will be skipped by Erase / Program operation. Note: If Erase is enabled and Erase type is "Chip", the compare will be skipped as after mass erase, the entire device is empty and needs to be re-programmed.
Erase	Performs an erase depending on the settings, selected in the drop down box: <ul style="list-style-type: none"> • Sectors: Erases all sectors which are effected by the image to be programmed. • Sectors if not blank: Erases all sectors which are both, effected by the image to be programmed and not already blank. • Chip: Erase the entire chip independent of the content.
Program	Programs the data file.

Command	Description
Verify	Verifies the programmed data by reading them back.

13.4.2 Global Settings

Global settings are available from the Options menu in the main window.

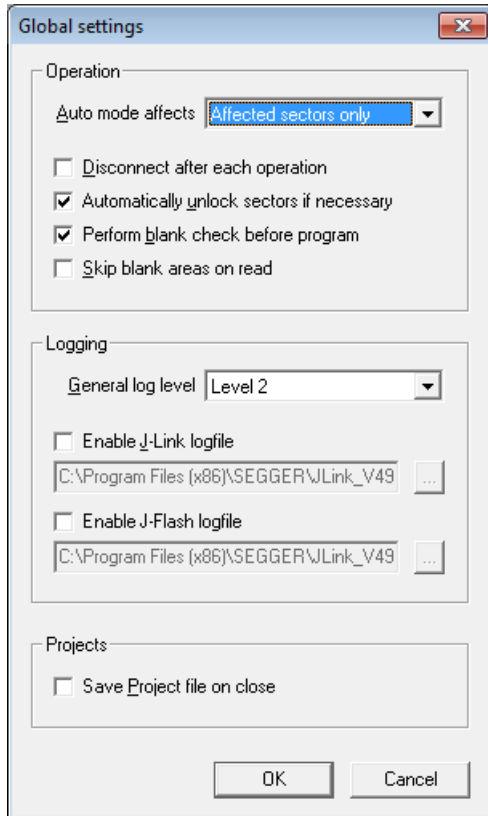

13.4.2.1 Operation

You may define the behavior of some operations such as "Auto" or "Program & Verify".

Disconnect after each operation

If this option is checked, connection to the target will be closed at the end of each operation.

Automatically unlock sectors

If this option is checked, all sectors affected by an erase or program operation will be automatically unlocked if necessary.

Perform blank check

If this option is checked, a blank check is performed before any program operation to examine if the affected flash sectors are completely empty. The user will be asked to erase the affected sectors if they are not empty.

Skip blank areas on read

If this option is checked, a blank check is performed before any read back operation to examine which flash areas need to be read back from target. This improves performance of read back operations since it minimizes the amount of data to be transferred via JTAG and USB.

13.4.2.2 Logging

You may set some logging options to customize the log output of J-Flash SPI.

General log level

This specifies the log level of J-Flash SPI. Increasing log levels result in more information logged in the log window.

Enable J-Link logfile

If this option is checked, you can specify a file name for the J-Link logfile. The J-Link logfile differs from the log window output of J-Flash SPI. It does not log J-Flash SPI operations performed. Instead of that, it logs the J-Link ARM DLL API functions called from within J-Flash SPI.

13.5 Command Line Interface

This chapter describes the J-Flash SPI command line interface. The command line allows using J-Flash SPI in batch processing mode and other advanced uses.

13.5.1 Overview

In addition to its traditional Windows graphical user interface (GUI), J-Flash SPI supports a command line mode as well. This makes it possible to use J-Flash SPI for batch processing purposes. All important options accessible from the menus are available in command line mode as well. If you provide command line options, J-Flash SPI will still start its GUI, but processing will start immediately.

The screenshot below shows the command line help dialog, which is displayed if you start J-Flash SPI in a console window with `JFlashSPI.exe -help` or `JFlashSPI.exe -?`.

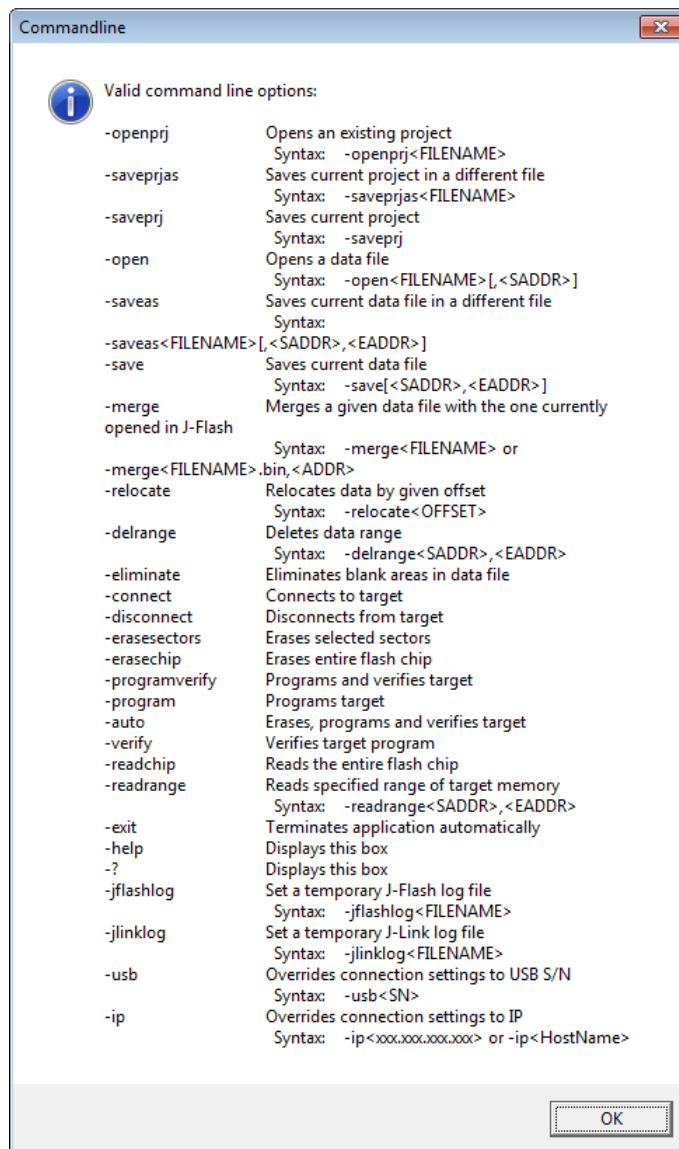

13.5.2 Command line options

This section lists and describes all available command line options. Some options accept additional parameters which are enclosed in angle brackets, e.g. <FILENAME>. If these parameters are optional they are enclosed in square brackets too, e.g. [<SADDR>]. Neither the angle nor the square brackets must be typed on the command line, they are used here only to denote (optional) parameters. Also, note that a parameter must follow immediately after the option, e.g. `JFlashSPI.exe -openprjC:\Projects\Default.jflash`.

The command line options are evaluated in the order they are passed to J-Flash, so please ensure that a project and data file has already been opened when evaluating a command line option which requires this.

It is recommended to always use `-open<FILENAME>[, <SADDR>]` to make sure the right data file is opened.

All command line options return 0 if the processing was successful. A return value unequal 0 means that an error occurred.

Note: Entries marked with "*" Do not work for J-Flash SPI_CL

Option	Description
-?	Displays the help dialog.
-auto	Executes the steps selected in Production Programming. Default: Erases, programs and verifies target.
-connect	Connects to the target.
-delrange<SADDR>,<EADDR>	* Deletes data in the given range.
-disconnect	Disconnects from the target.
-eliminate	* Eliminates blank areas in data file.
-erasechip	Erases the entire flash chip.
-erasesectors	Erases selected sectors.
-exit	* Exits J-Flash SPI.
-help	Displays the help dialog.
-jflashlog<FILENAME>	Sets a temporary J-Flash SPI logfile.
-jlinklog<FILENAME>	Sets a temporary J-Link logfile.
<ul style="list-style-type: none"> • -merge<FILENAME> • -merge<FILENAME>.bin,<ADDR> 	* Saves the current data file into the specified file. Please note that the parameters <SADDR>,<EADDR> apply only if the data file is a *.bin file or *.c file.
-min	* Starts application minimized
-open<FILENAME>[,<SADDR>]	Opens a data file. Please note that the <SADDR> parameter applies only if the data file is a *.bin file
-openprj<FILENAME>	Opens an existing project file. This will also automatically open the data file that has been recently used with this project.
-program	Programs the target.
-programverify	Programs and verify the target.
-readchip	Reads the entire flash chip.
-readrange<SADDR>,<EADDR>	Reads specified range of target memory.
-relocate<Offset>	* Relocate data by <Offset>.
-save[<SADDR>,<EADDR>]	Saves the current data file. Please note that the parameters <SADDR>,<EADDR> apply only if the data file is a *.bin file or *.c file.
-saveas<FILENAME>[,<SADDR>,<EADDR>]	Saves the current data file into the specified file. Please note that the parameters <SADDR>,<EADDR> apply only if the data file is a *.bin file or *.c file.
-saveprj	* Saves the current project.
-saveprjas<FILENAME>	* Saves the current project in the specified file.
-verify	Verifies the target memory.

Option	Description
-usb<SN>	Overrides connection settings to USB S/N.
<ul style="list-style-type: none"> -ip<xxx.xxx.xxx.xxx> -ip<HostName> 	Overrides connection settings to IP.
-speed<SpeedInKHZ>	Sets the connection speed NOTE: Only J-Flash SPI_CL
-verbose<Level>	Sets the log verbosity level to <Level>. <Level>-range is from 0-9 NOTE: Only J-Flash SPI_CL

13.5.3 Batch processing

J-Flash SPI can be used for batch processing purposes. All important options are available in command line mode as well. When providing command line options, the application does not wait for manual user input. All command line operations will be performed in exactly the order they are passed. So, for example issuing a program command before a project has been opened will cause the program command to fail.

The example batchfile below will cause J-Flash SPI to perform the following operations:

1. Open project C:\Projects\Default.jflash
2. Open bin file C:\Data\data.bin and set start address to 0x100000
3. Perform "Auto" operation in J-Flash (by default this performs erase, program, verify)
4. Close J-Flash SPI

The return value will be checked and in case of an error message will be displayed. Adapt the example according to the requirements of your project.

```
@ECHO OFF

ECHO Open a project and data file, start auto processing and exit
JFlashSPI.exe -openprjC:\Projects\Default.jflash -openC:\Data
\data.bin,0x100000 -auto -exit
IF ERRORLEVEL 1 goto ERROR

goto END

:ERROR
ECHO J-Flash SPI: Error!
pause

:END
```

Starting J-Flash minimized

Adapt this example call to start J-Flash SPI minimized:

```
start /min /wait "J-Flash" "JFlashSPI.exe" -openprjC:\Projects\Default.jflash \
-openC:\Data\data.bin,0x100000 -auto -exit
```

Note

Every call of JFlashSPI.exe has to be completed with the -exit option, otherwise the execution of the batch file stops and the following commands will not be processed.

13.5.4 Programming multiple targets in parallel

In order to program multiple targets in parallel using J-Flash SPI, the following is needed:

- Multiple J-Flash SPI projects, each configured to connect to a specific J-Link / Flasher (emulator to connect to is selected by serial number).

The easiest way is to setup the appropriate project once and then make multiple copies of this project. Now modify the [Connection to J-Link](#) setting in each project, in order to let J-Flash SPI connect to the different programmers as shown in the screenshot below: Find below a small sample which shows how to program multiple targets in parallel:

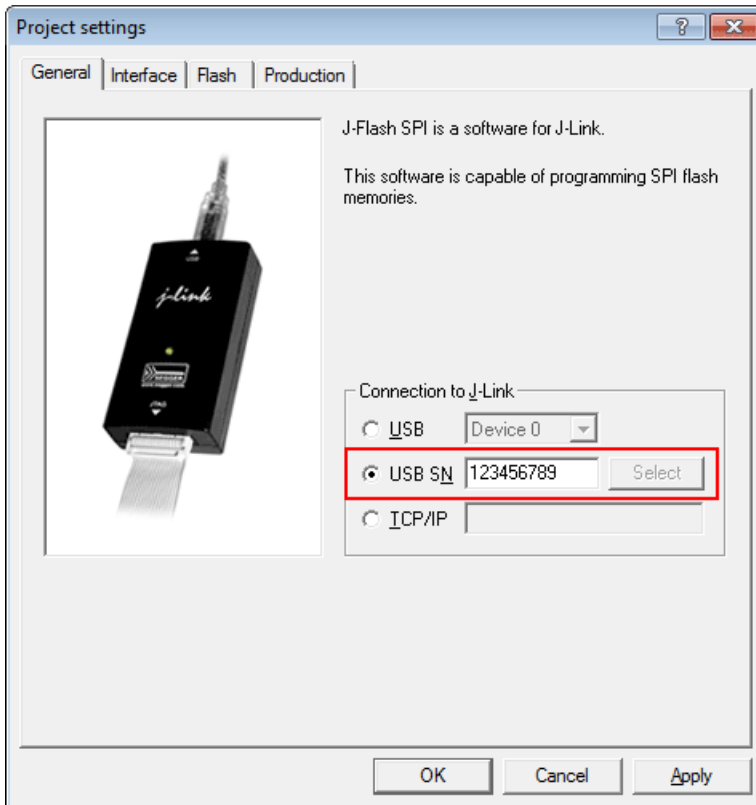

```
@ECHO OFF
```

```
ECHO Open first project which is configured to connect to the first J-Link.
ECHO Open data file, start auto processing and exit
open JFlashSPI.exe -openprjC:\Projects\Project01.jflash -openC:\Data\data.bin,
0x100000 -auto -exit
IF ERRORLEVEL 1 goto ERROR
```

```
ECHO Open second project which is configured to connect to the second J-Link.
ECHO Open data file, start auto processing and exit
open JFlashSPI.exe -openprjC:\Projects\Project02.jflash -openC:\Data\data.bin,
0x100000 -auto -exit
IF ERRORLEVEL 1 goto ERROR
```

```
ECHO Open third project which is configured to connect to the third J-Link.
ECHO Open data file, start auto processing and exit
open JFlashSPI.exe -openprjC:\Projects\Project03.jflash -openC:\Data\data.bin,
0x100000 -auto -exit
IF ERRORLEVEL 1 goto ERROR
```

```
goto END
```

```
:ERROR
ECHO J-Flash SPI: Error!
pause
:END
```

Note

Every call of `JFlashSPI.exe` has to be completed with the `-exit` option, otherwise the execution of the batch file stops and the following commands will not be processed.

13.6 Creating a new J-Flash SPI project

Creating a new project for J-Flash is pretty simple. In the following, all necessary steps to create a project file are explained.

1. Select **File -> New Project** to create a new project with default settings.
2. Open the **Project Settings** context menu. Select **Options -> Project Settings** to open the **Project settings** dialog and select the type of connection to J-Link.

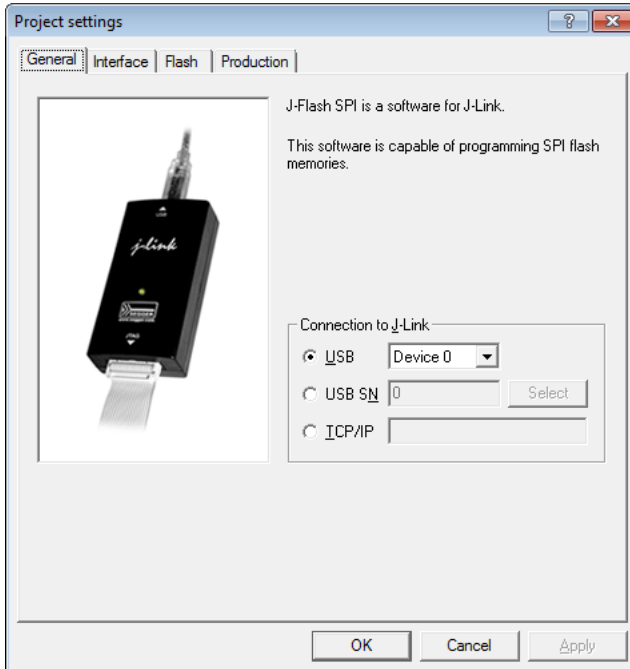

3. Define the **SPI communication speed**. The default settings work without any problem for most targets, but to achieve the last quantum of performance, manual tuning may be necessary.

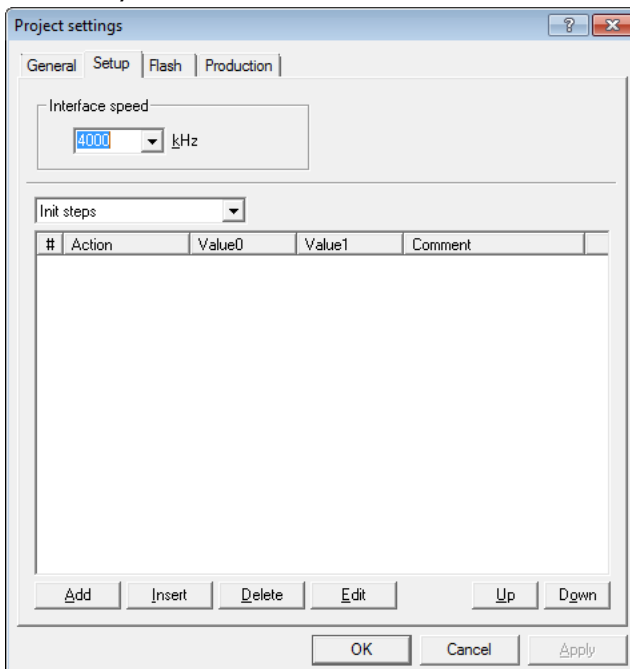

4. Open the **Flash** and either select **Automatically detect SPI flash** or manually enter the flash parameters.
5. Save the project (**File -> Save Project**) and test it.

13.7 Custom Command Sequences

J-Flash SPI supports sending custom command sequences, which may be different for different SPI flashes (e.g. program OTP, program security register, etc...), via the SPI interface. Due to the generic syntax, this feature can be used to implement any kind of required command sequence. The sequence is stored in the J-Flash SPI project file (*.jflash) and therefore it can be included in automated production environments without any problems and be used with the command line version of J-Flash SPI as well.

The custom command sequence can be configured in the `Setup` tab of the J-Flash project settings as part of the `Init / Exit Steps` which allow to enter custom sequences using a pre-defined list of operations. The following list shows all valid commands which can be used:

Command	Value0	Value1	Description
Delay	Delay in ms	--	Waits a given time
Activate CS	--	--	Sets the CS signal low
Deactivate CS	--	--	Sets the CS signal high
Write data	NumByte(s)	ByteStream separated by commas (hex)	Sends a number of bytes via the SPI interface to the SPI. (e.g.: 9F,13,CA)
Var Read Data	OffInVarBuffer	NumByte(s) max. 16 bytes	Reads the specified number of bytes via the SPI interface into the Var-Buffer which is 16 bytes in size.
Var Write Data	OffInVarBuffer	NumByte(s) max. 16 bytes	Writes the specified number of bytes via the SPI interface from the Var-Buffer (filled via Var Read).
Var AND	ByteIndex	Value (hex)	Logical AND combination of the internal var buffer at the specified index with a given value.
Var OR	ByteIndex	Value (hex)	Logical OR combination of the internal var buffer at the specified index with a given value.
Var XOR	ByteIndex	Value (hex)	Logical XOR combination of the internal var buffer at the specified index with a given value.

13.7.1 Init / Exit steps

The init sequence will be performed as part of the connect sequence, for example to disable security, while the exit sequence will be executed after programming, for example to enable the security in order to secure the SPI flash.

13.7.2 Example

The example below demonstrates how to use the custom command sequence feature to implement a read-modify-write security register on the Winbond W25Q128FVSI SPI flash using the init steps. To make sure that the output of the example is exactly the same, the sample erases the security register to have defined values.

Step #0 to Step#2: Set Write Enable
 Step #3 to Step#6: Erase security register to have a defined values (0xFF)
 Step #7 to Step#11: Read 16 byte security register into Var buffer
 Step #12 to Step#19: Modify the data in the Var buffer
 Step #20 to Step#22: Set Write Enable
 Step #23 to Step#27: Program security register with values from Var buffer
 Step #28 to Step#32: Read back security register to verify successful programming

#	Action	Value0	Value1	Comment
0	Activate CS	--	--	Activate CS
1	Write Data	1	06	Send command: Write Enable
2	Deactivate CS	--	--	Deactivate CS
3	Activate CS	--	--	Activate CS
4	Write Data	4	44,00,10,00	Send command: Erase Security Register 1
5	Deactivate CS	--	--	Deactivate CS
6	Delay	200ms	--	Wait until security register 1 has been erased
7	Activate CS	--	--	Activate CS
8	Write Data	4	48,00,10,00	Send Read Security Register: 1b command + 3b addr
9	Write Data	1	FF	Send 8 dummy clocks
10	Var Read Data	0	16	Read actual security register data (16 byte) into Varbuffer[0]
11	Deactivate CS	--	--	Deactivate CS
12	Var AND	0	0x00	Set byte 0 to 0x00 using Var AND
13	Var OR	0	0x12	Set byte 0 to 0x12 using Var OR
14	Var AND	6	0x00	Set byte 6 to 0x00 using Var AND
15	Var OR	6	0x12	Set byte 6 to 0xAB using Var OR
16	Var AND	12	0x00	Set byte 12 to 0x00 using Var AND
17	Var OR	12	0x12	Set byte 12 to 0xCC using Var OR
18	Var AND	15	0x00	Set byte 15 to 0x00 using Var AND
19	Var OR	15	0x12	Set byte 15 to 0x4E using Var OR
20	Activate CS	--	--	Activate CS
21	Write Data	1	06	Send command: Write Enable
22	Deactivate CS	--	--	Deactivate CS
23	Activate CS	--	--	Activate CS
24	Write Data	4	42,00,10,00	Send command: Program Security Register 1
25	Var Write Data	0	16	Send data: Program sec reg 1_1
26	Deactivate CS	--	--	Deactivate CS
27	Delay	200ms	--	Wait until security register 1 has been erased
28	Activate CS	--	--	Activate CS
29	Write Data	4	48,00,10,00	Send Read Security Register: 1b command + 3b addr
30	Write Data	1	FF	Send 8 dummy clocks
31	Var Read Data	0	16	Read actual security register data (16 byte) into Varbuffer[0]
32	Deactivate CS	--	--	Deactivate CS

13.7.3 J-Flash SPI Command Line Version

As the Init / Exit Steps are stored in the J-Flash project file, which is evaluated in the command line version of J-Flash SPI too, the custom command sequence feature can be used under Linux / MAC, as well. The project can be either created using the GUI version of J-Flash SPI or by editing the *.jflash project, manually. The expected format of the custom command sequences in the J-Flash project file is described below.

13.7.3.1 J-Flash project layout

Basically, the custom sequence is separated into different steps where each step contains the fields as in the table below. Some commands require to pass parameter to it. They are stored in Value0 and Value1 as described in the table below.

Step	Description
ExitStepX_Action = "\$Action\$"	Any action as described in the table below.
ExitStepX_Comment = "\$Comment\$"	User can specify any comment here. This field is optional and not taken into account.
ExitStepX_Value0 = "\$Value0\$"	Value depends on the action. See table below
ExitStepX_Value1 = "\$Value1\$"	Value depends on the action. See table below

The number of exit steps needs to be specified right behind the ExitStep sequence with the line "NumExitSteps = <NumExitSteps>" (see example below).

Actions	Parameter	Description
Activate CS	none	Set CS signal low
Deactivate CS	none	Set CS signal high
Write data	Value0=NumBytes Value1[x]=ByteStream max. NumBytes is 16	Send a number of bytes via the SPI interface to the SPI. Please note, that the number of bytes has to be specified right behind Value1 in square brackets (e.g.: ExitStep4_Value1[3] = 0x44,0x00,0x10)
Delay	Value0=Delay in ms	Waits a given time

Below is a small example excerpt from a J-Flash project, which shows an example sequence to erase sector 0 of the SPI flash using the 0xD8 command. Further examples can be found in the installation directory of the J-Link software and documentation package.

```
[CPU]
//
// Set write enable
//
ExitStep0_Action = "Activate CS"
ExitStep0_Value0 = 0x00000000
ExitStep0_Value1 = 0x00000000
ExitStep1_Action = "Write data"
ExitStep1_Comment = "Set write enable"
ExitStep1_Value0 = 1
ExitStep1_Value1[1] = 0x06
ExitStep2_Action = "Deactivate CS"
ExitStep2_Comment = "Deactivate CS"
ExitStep2_Value0 = 0x00000000
ExitStep2_Value1 = 0x00000000
//
// Erase sector 0
//
ExitStep3_Action = "Activate CS"
ExitStep3_Comment = "Activate CS"
ExitStep3_Value0 = 0x00000000
ExitStep3_Value1 = 0x00000000
ExitStep4_Action = "Write data"
ExitStep4_Comment = "Set write enable"
ExitStep4_Value0 = 4
ExitStep4_Value1[4] = 0xD8,0x00,0x00,0x00
ExitStep5_Action = "Deactivate CS"
ExitStep5_Comment = "Deactivate CS"
ExitStep5_Value0 = 0x00000000
ExitStep5_Value1 = 0x00000000
//
// Wait until sector has been erased
```

```
//  
ExitStep6_Action = "Delay"  
ExitStep6_Comment = "Wait until sector has been erased"  
ExitStep6_Value0 = 0x00000080  
ExitStep6_Value1 = 0x00000000  
NumExitSteps = 7
```

13.8 Device specifics

This chapter gives some additional information about specific devices.

13.8.1 SPI flashes with multiple erase commands

Some SPI flashes support multiple erase commands that allow to erase different units on the flash. For example some flashes provide a `sector erase` (erase 4 KB units) and a `block erase` (erase 16 KB or 64 KB units) command. In general, it is up to the user which command to use, as the `EraseSector` command can be overridden by the user. When manually changing the `SectorErase` command in the **Options** -> **Project settings...** -> **Flash** tab, make sure that the `SectorSize` parameter matches the command being used

13.9 Target systems

13.9.1 Which flash devices can be programmed?

In general, all kinds of SPI flash can be programmed. Since all flash parameters are configurable, also flashes with non-standard command sets can be programmed.

13.10 Performance

The following chapter lists programming performance for various SPI flash devices.

13.10.1 Performance values

In direct programming mode (J-Link directly connects to the pins of the SPI flash), the programming speed is mainly limited by the SPI communication speed, the USB speed of J-Link (if a Full-Speed or Hi-Speed based J-Link is used) and the maximum programming speed of the flash itself.

For most SPI flash devices, in direct programming mode speeds of ≥ 50 KB/s can be achieved.

13.11 Background information

This chapter provides some background information about specific parts of the J-Flash SPI software.

13.11.1 SPI interface connection

For direct SPI flash programming, J-Link needs to be wired to the SPI flash in a specific way. For more information about the pinout for the J-Link SPI target interface, please refer to the J-Link Manual (UM08001). The minimum pins that need to be connected, are: VTref, GND, SPI-CLK, MOSI, MISO. If other components on the target hardware need to be kept in reset while programming the SPI flash (e.g. a CPU etc.), nRESET also needs to be connected.

13.12 Support

The following chapter provides advises on troubleshooting for possible typical problems and information about how to contact our support.

13.12.1 Troubleshooting

13.12.1.1 Typical problems

Target system has no power

Meaning:

J-Link could not measure the target (flash) reference voltage on pin 1 of its connector.

Remedy:

The target interface of J-Link works with level shifters to be as flexible as possible. Therefore, the reference I/O voltage the flash is working with also needs to be connected to pin 1 of the J-Link connector.

Programming / Erasing failed

Meaning:

The SPI communication speed may be too high for the given signal quality.

Remedy:

Try again with a slower speed. If it still fails, check the quality of the SPI signals.

Failed to verify Flash ID

Meaning:

J-Link could not verify the ID of the connected flash.

Remedy:

Check the Flash ID entered in the flash parameters dialog, for correctness.

13.12.2 Contacting support

If you experience a J-Flash SPI related problem and advice given in the sections above does not help you to solve it, you may contact our support. In this case, please provide us with the following information:

- A detailed description of the problem.
- The relevant log file and project file. In order to generate an expressive log file, set the log level to "All messages" (see section *Global Settings* for information about changing the log level in J-Flash SPI).
- The relevant data file as a .hex or .mot file (if possible).
- The processor and flash types used.

Once we received this information we will try our best to solve the problem for you. Our contact address is as follows:

SEGGER Microcontroller GmbH

Ecolab-Allee 5
D-40789 Monheim am Rhein

Germany

Tel. +49-2173-99312-0
Fax. +49-2173-99312-28
E-mail: support@segger.com
Internet: www.segger.com

Chapter 14

RDI

RDI (Remote Debug Interface) is a standard defined by ARM, trying to standardize a debugger / debug probe interface. It is defined only for cores that have the same CPU register set as ARM7 CPUs. This chapter describes how to use the RDI DLL which comes with the J-Link Software and Documentation Package. The J-Link RDI DLL allows the user to use J-Link with any RDI-compliant debugger and IDE.

14.1 Introduction

Remote Debug Interface (RDI) is an Application Programming Interface (API) that defines a standard set of data structures and functions that abstract hardware for debugging purposes. J-Link RDI mainly consists of a DLL designed for ARM cores to be used with any RDI compliant debugger. The J-Link DLL feature flash download and flash breakpoints can also be used with J-Link RDI.

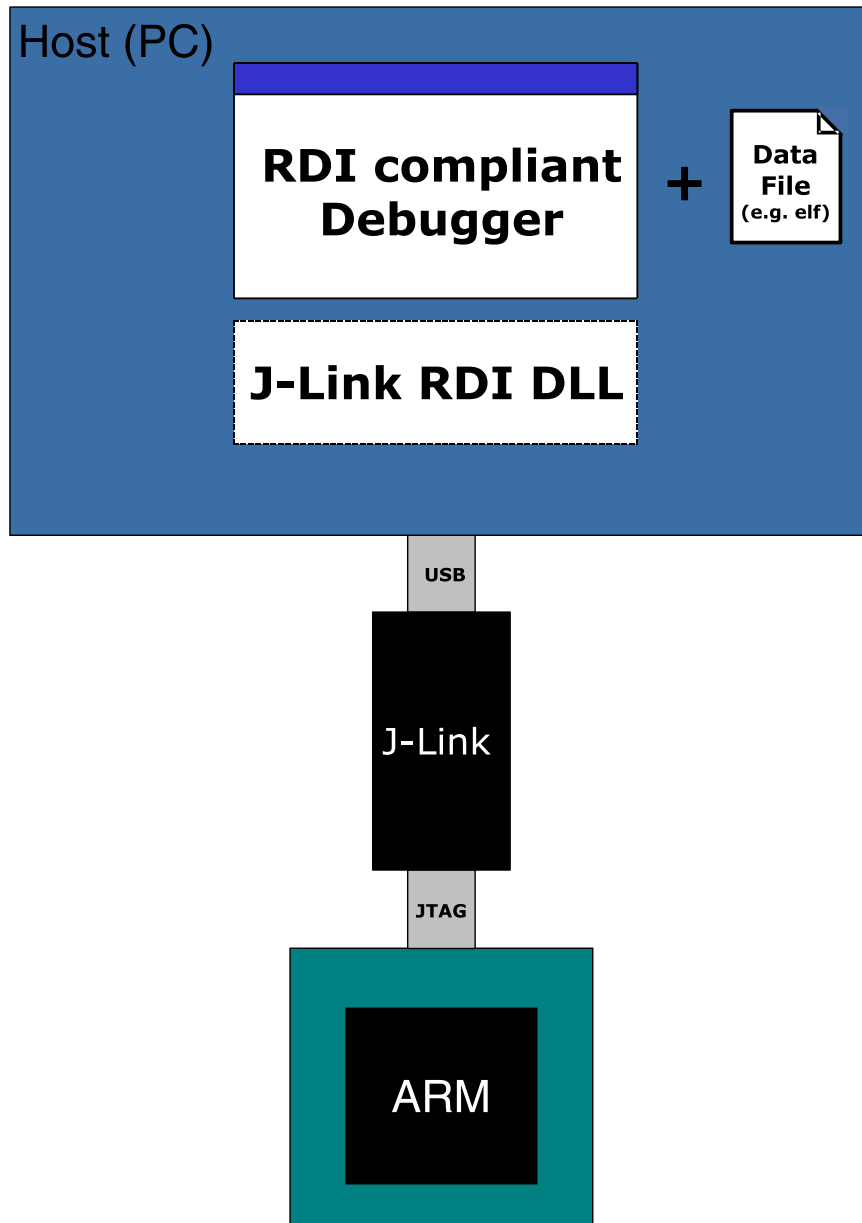

14.1.1 Features

- Can be used with every RDI compliant debugger.
- Easy to use.
- Flash download feature of J-Link DLL can be used.
- Flash breakpoints feature of J-Link DLL can be used.
- Instruction set simulation (improves debugging performance).

14.2 Licensing

In order to use the J-Link RDI software a separate license is necessary for each J-Link. For some devices J-Link comes with a device-based license and some J-Link models also come with a full license for J-Link RDI. The normal J-Link however, comes without any licenses. For more information about licensing itself and which devices have a device-based license, please refer to:

[J-Link Model overview: Licenses](#)

14.3 Setup for various debuggers

The J-Link RDI software is an ARM Remote Debug Interface (RDI) for J-Link. It makes it possible to use J-Link with any RDI compliant debugger. Basically, J-Link RDI consists of a additional DLL (JLinkRDI.dll) which builds the interface between the RDI API and the normal J-Link DLL. The JLinkRDI.dll itself is part of the J-Link Software and Documentation Package.

Please refer to [SEGGER Wiki: Getting Started with Various IDEs](#) for information on how to get started with any IDE officially supported by J-Link / J-Trace. If official support is not implemented natively but via RDI, the RDI setup procedure will also be explained there. In the following, the RDI setup procedure for a few **not officially supported IDEs** is explained.

14.3.1 ARM AXD (ARM Developer Suite, ADS)

Software version

The JLinkRDI.dll has been tested with ARM's AXD version 1.2.0 and 1.2.1. There should be no problems with other versions of ARM's AXD. All screenshots are taken from ARM's AXD version 1.2.0.

Configuring to use J-Link RDI

1. Start the ARM debugger and select **Options | Configure Target...** . This opens the Choose Target dialog box:

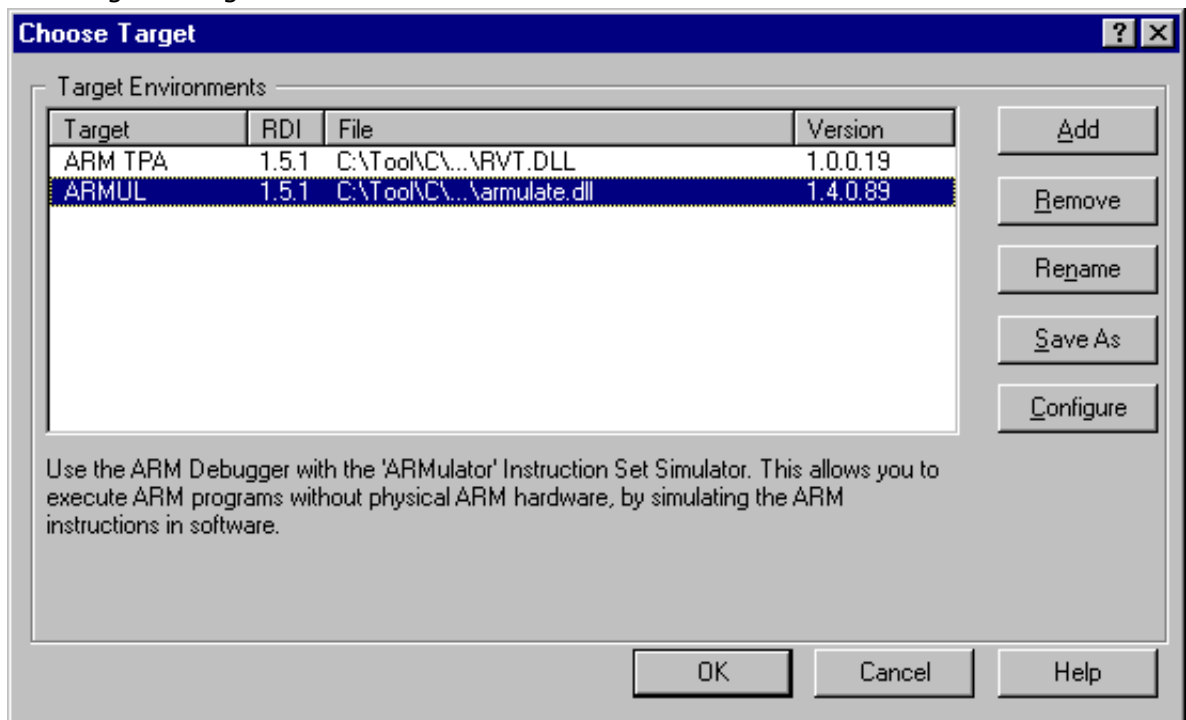

2. Press the **Add** Button to add the JLinkRDI.dll.

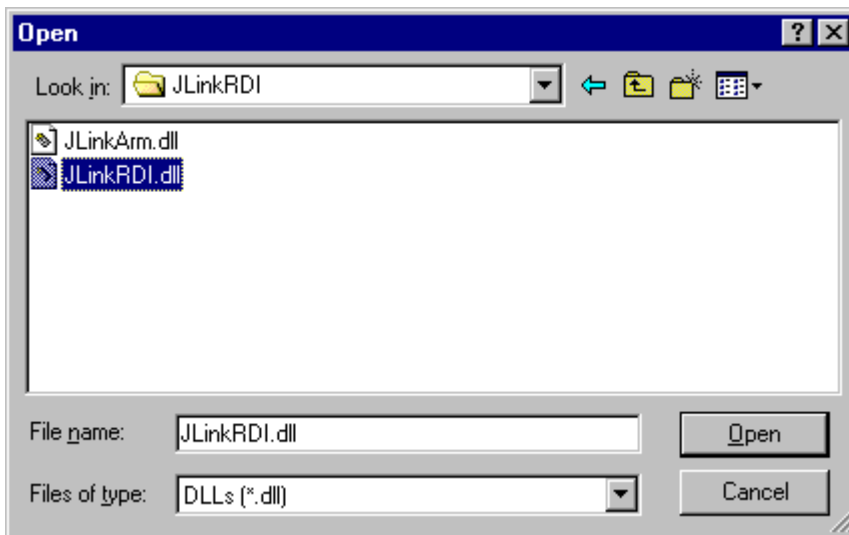

3. Now J-Link RDI is available in the **Target Environments** list.

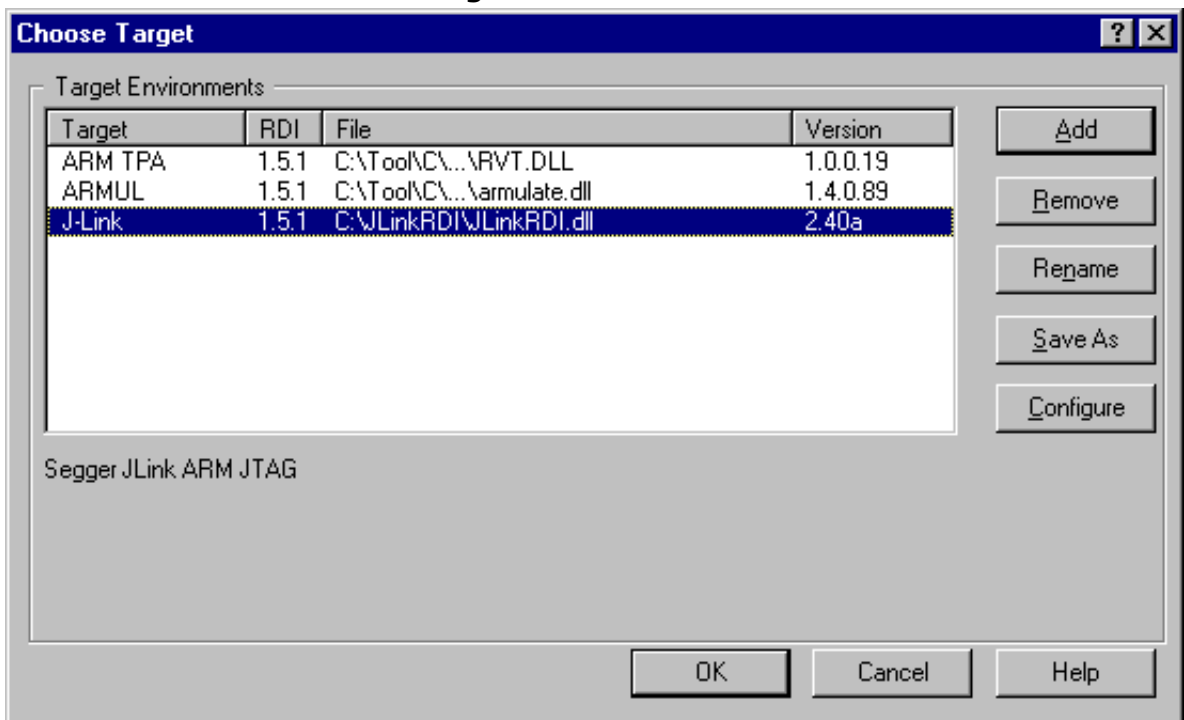

4. Select J-Link and press **OK** to connect to the target via J-Link. For more information about the generic setup of J-Link RDI, please refer to *Configuration* on page 331. After downloading an image to the target board, the debugger window looks as follows:

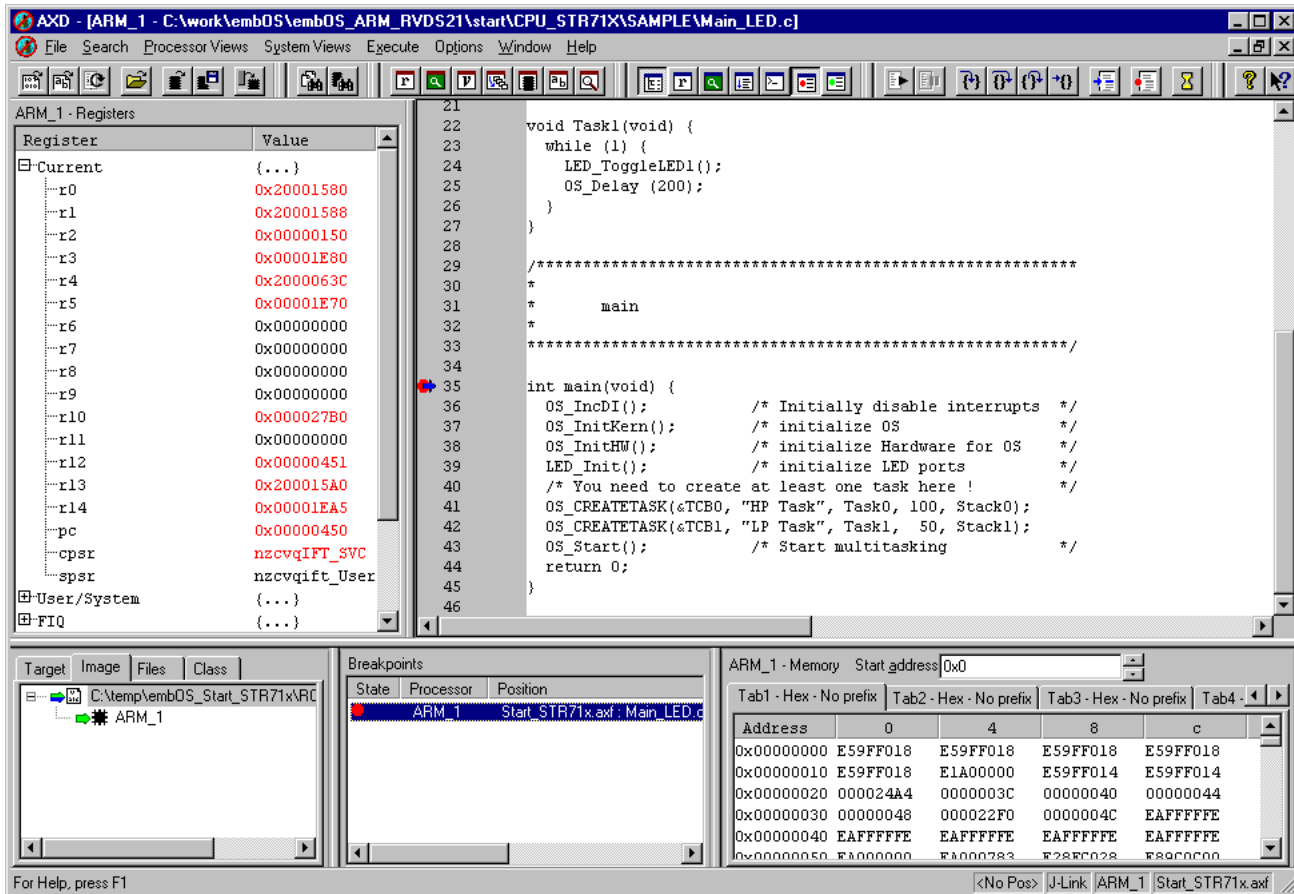

14.3.2 ARM RVDS (RealView developer suite)

Software version

J-Link RDI has been tested with ARM RVDS version 2.1 and 3.0. There should be no problems with earlier versions of RVDS (up to version v3.0.1). All screenshots are taken from ARM's RVDS version 2.1.

Note

RVDS version 3.1 does not longer support RDI protocol to communicate with the debugger.

Configuring to use J-Link RDI

1. Start the Real View debugger:

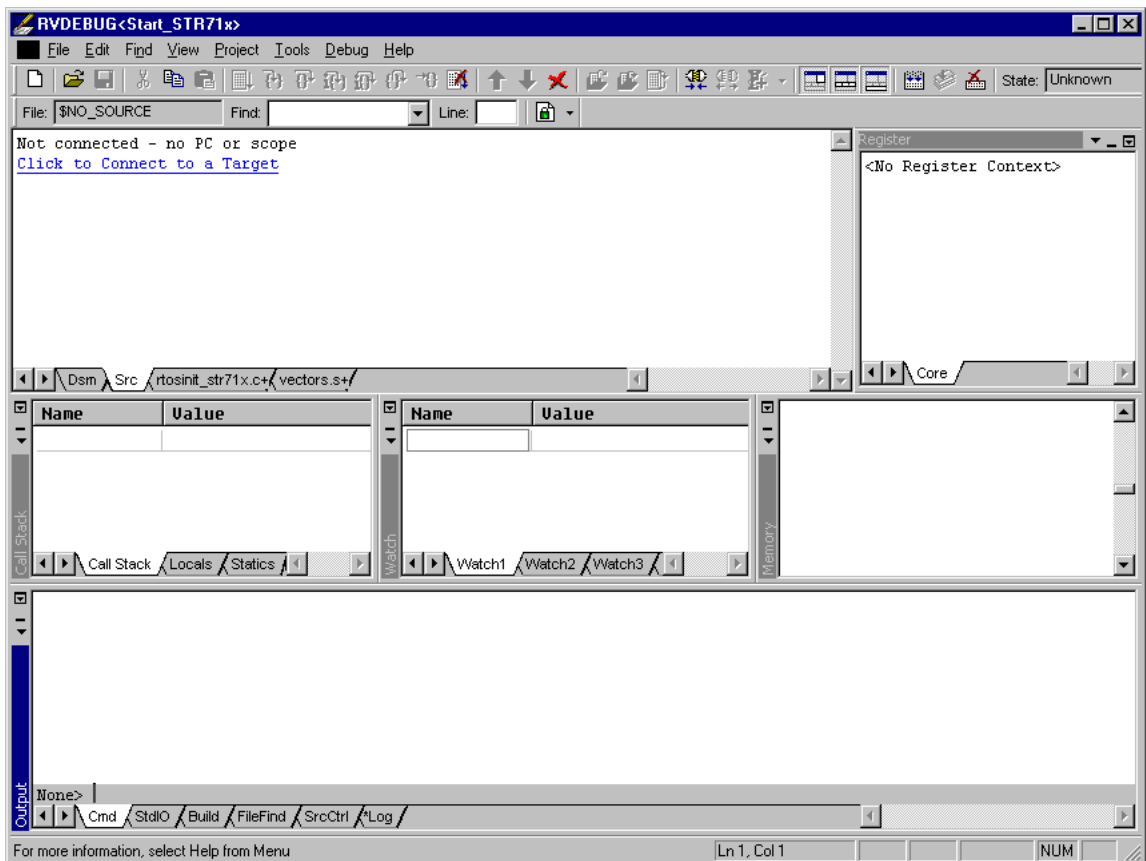

2. Select **File | Connection | Connect to Target**.

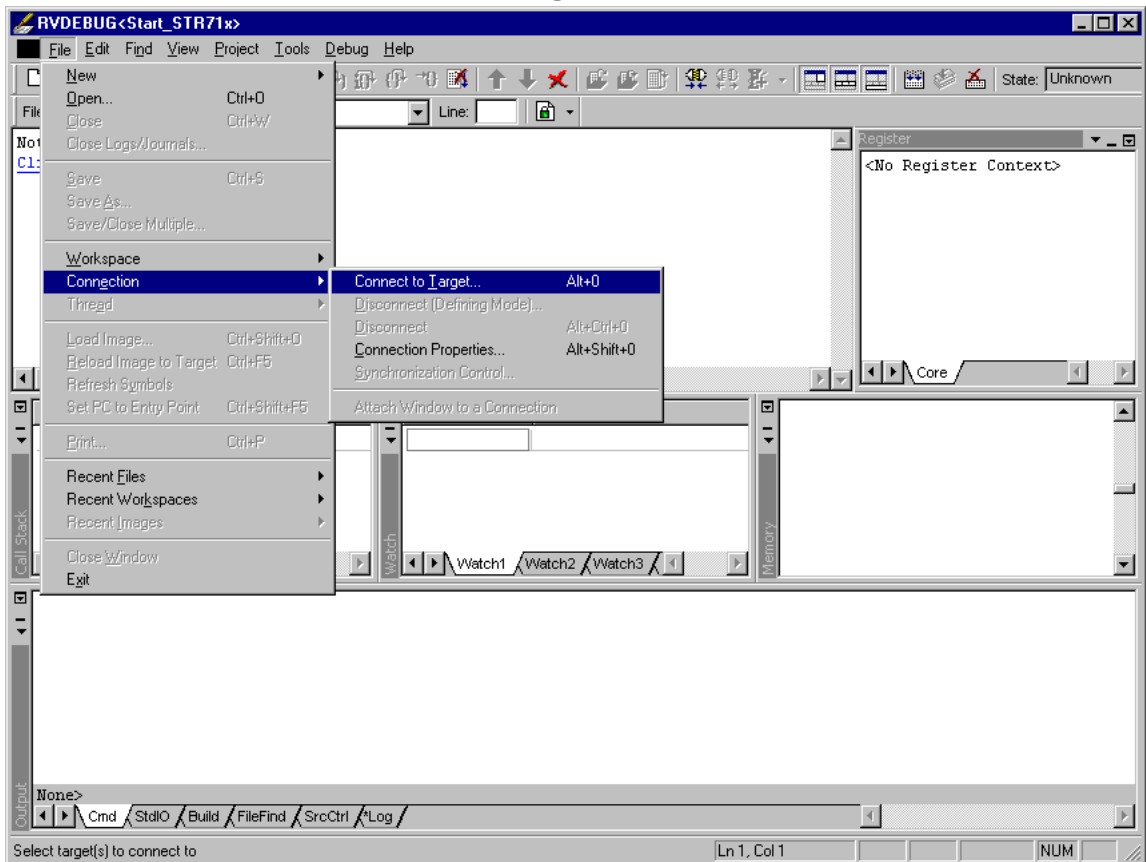

3. In the **Connection Control** dialog use the right mouse click on the first item and select **Add/Remove/Edit Devices**.

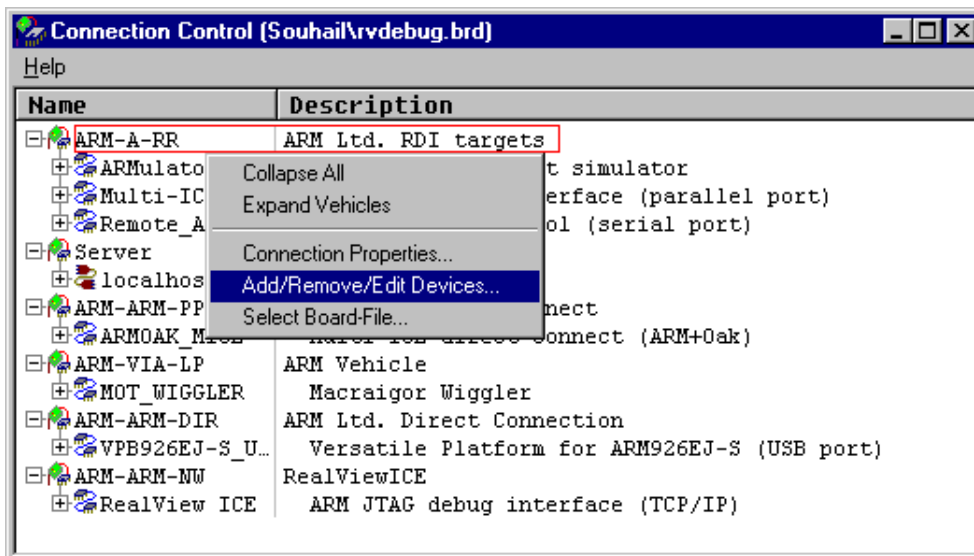

- Now select **Add DLL** to add the JLinkRDI.dll. Select the installation path of the software, for example: C:\Program Files\SEGGER\JLinkARM_V350g\JLinkRDI.dll

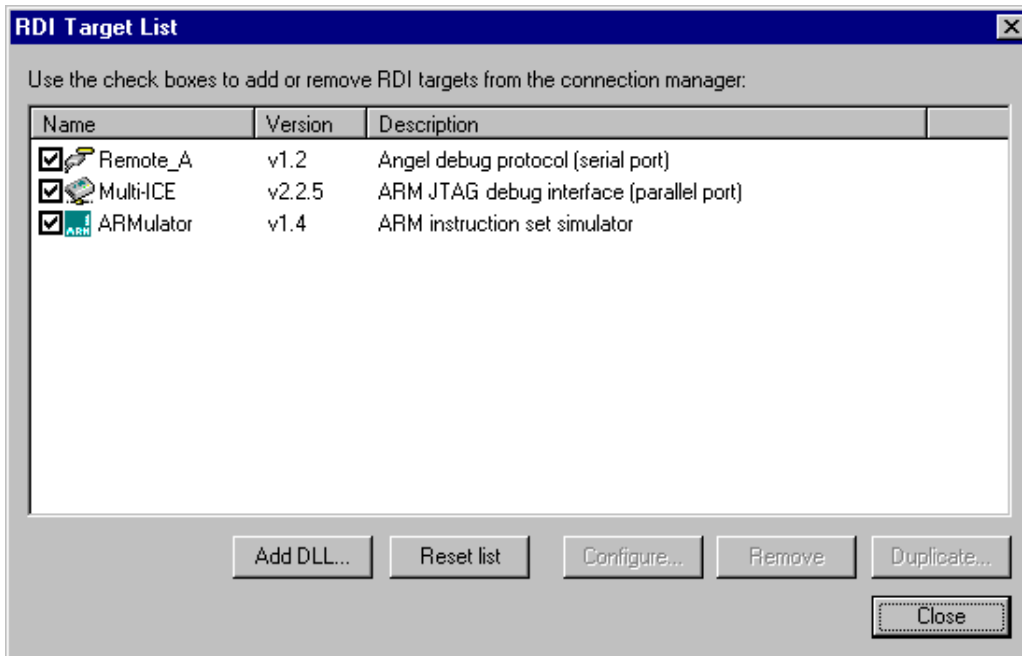

- After adding the DLL, an additional Dialog opens and asks for description: (These values are voluntary, if you do not want change them, just click **OK**) Use the following values and click on **OK**, **Short Name:** JLinkRDI **Description:** J-Link RDI Interface.

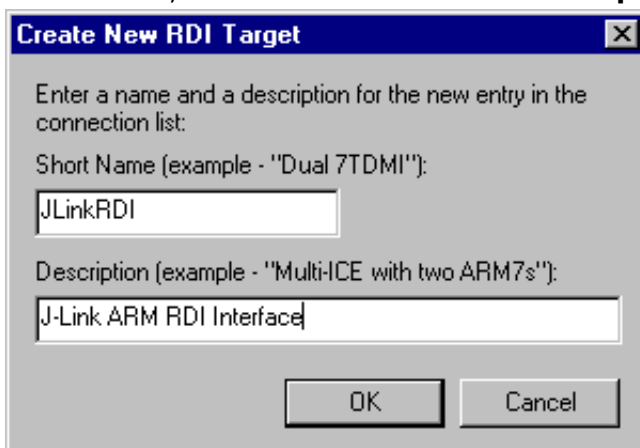

- Back in the **RDI Target List Dialog**, select **JLink-RDI** and click **Configure**. For more information about the generic setup of J-Link RDI, please refer to *Configuration* on page 331.

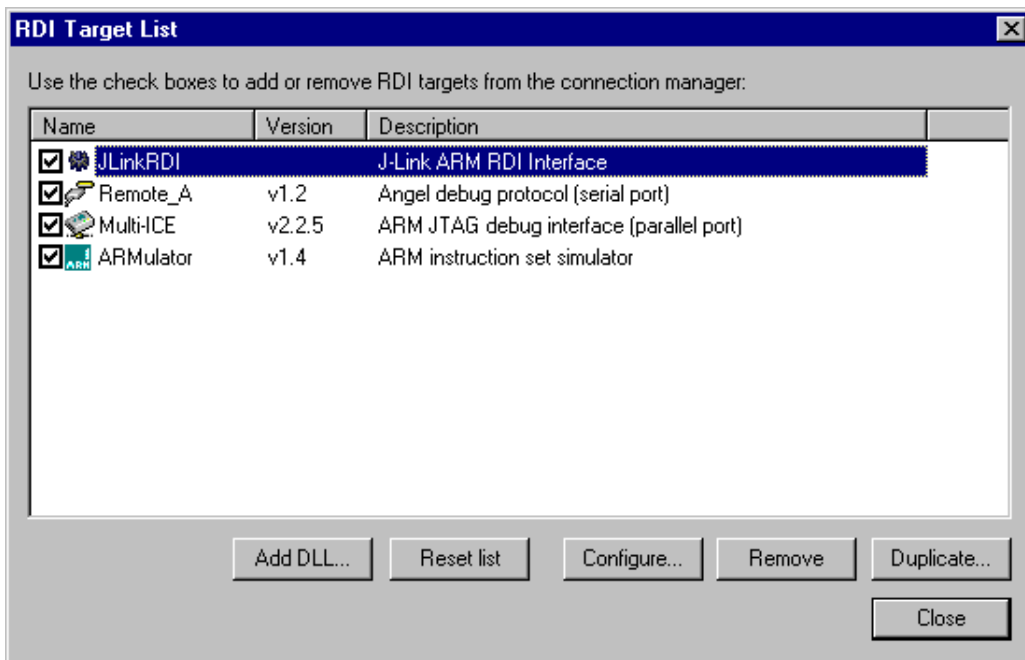

- Click the **OK** button in the configuration dialog. Now close the **RDI Target List** dialog. Make sure your target hardware is already connected to J-Link.
- In the **Connection control** dialog, expand the **JLink ARM RDI Interface** and select the ARM_0 processor. Close the **Connection Control** window.

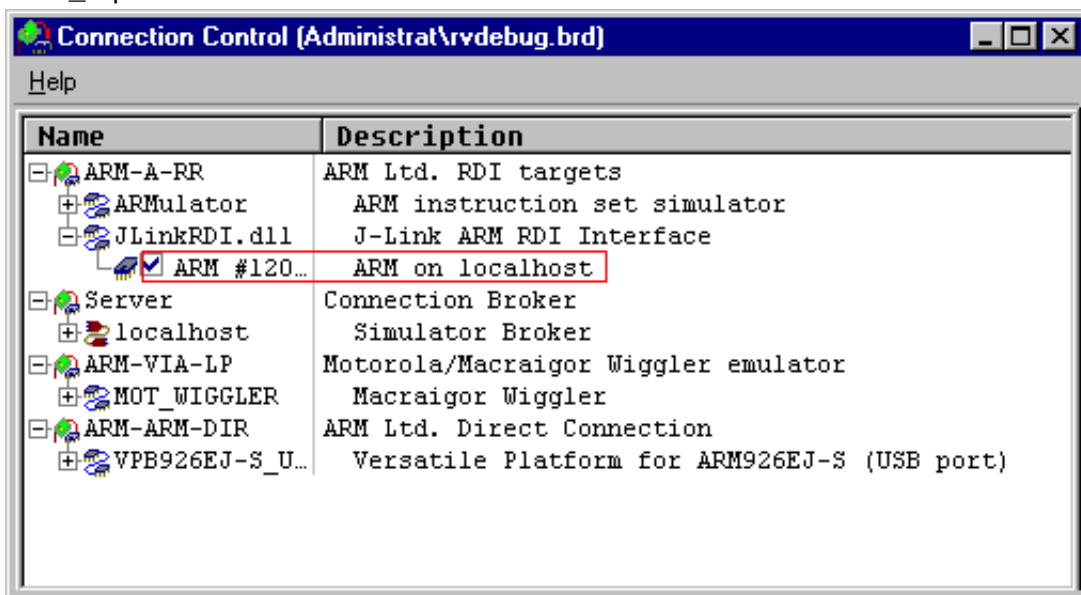

- Now the RealView Debugger is connected to J-Link.

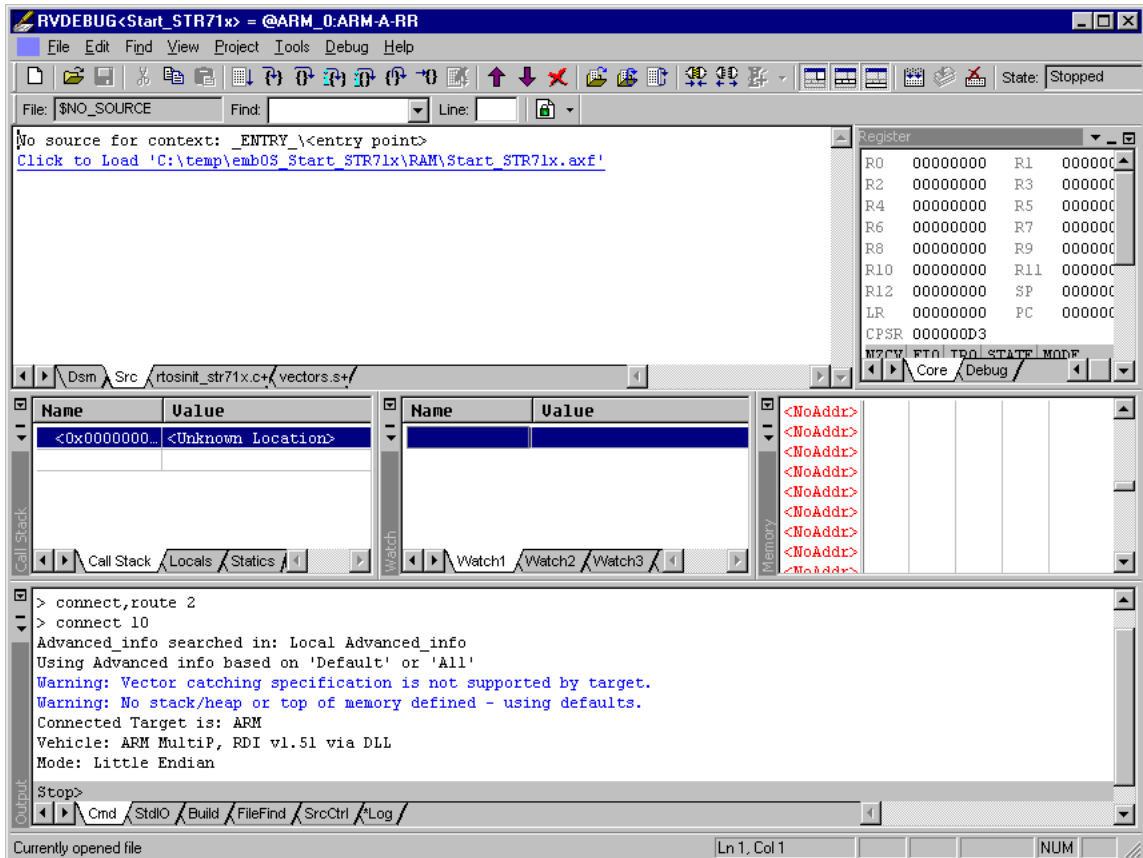

10. A project or an image is needed for debugging. After downloading, J-Link is used to debug the target.

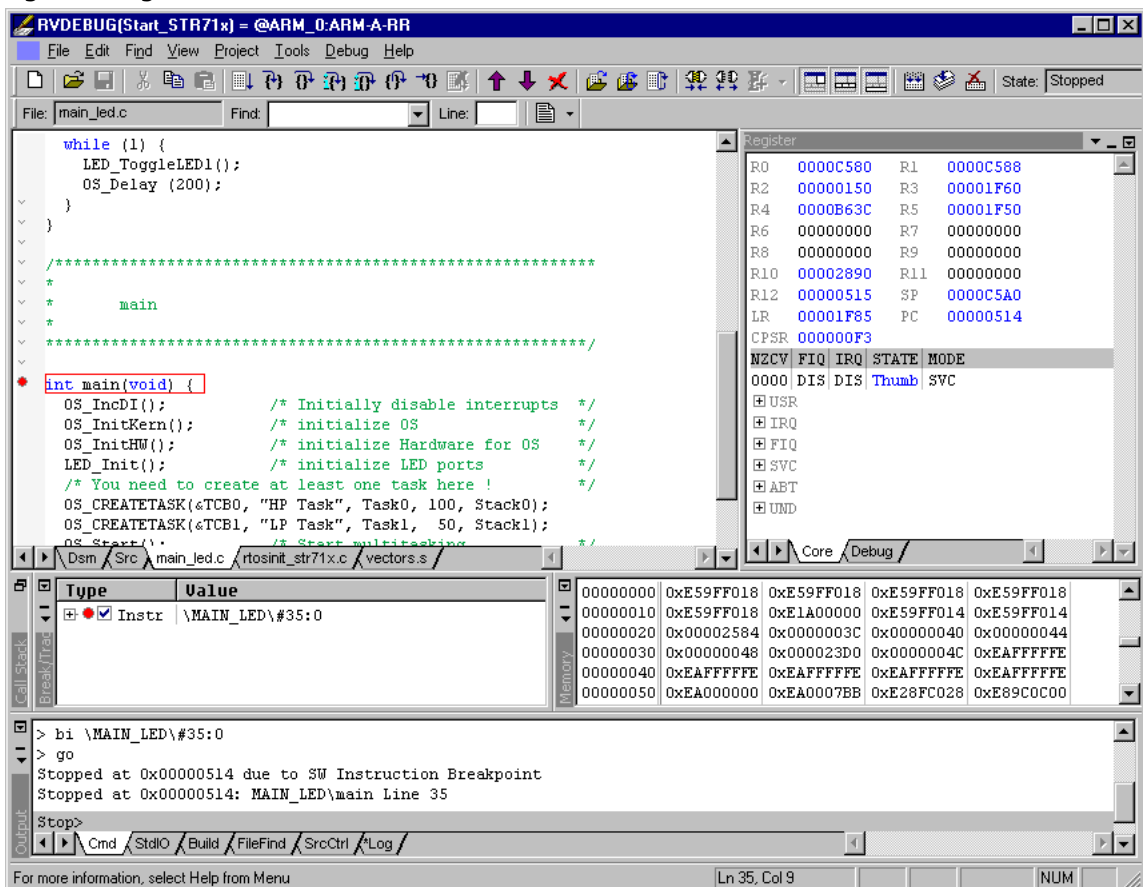

14.3.3 GHS MULTI

Software version

J-Link RDI has been tested with GHS MULTI version 4.07. There should be no problems with other versions of GHS MULTI. All screenshots are taken from GHS MULTI version 4.07.

Configuring to use J-Link RDI

1. Start Green Hills Software MULTI integrated development environment. Click **Connect** | **Connection Organizer** to open the **Connection Organizer**.

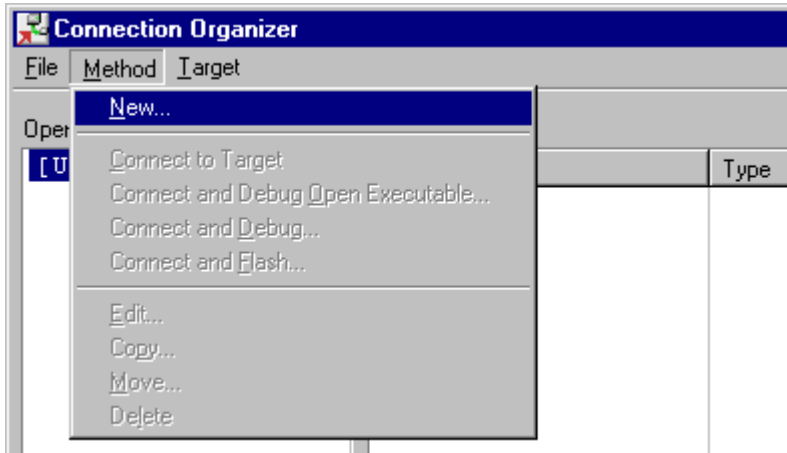

2. Click **Method** | **New** in the **Connection Organizer** dialog.
3. The **Create a new Connection Method** will be opened. Enter a name for your configuration in the **Name** field and select **Custom** in the **Type** list. Confirm your choice with the **Create...** button.

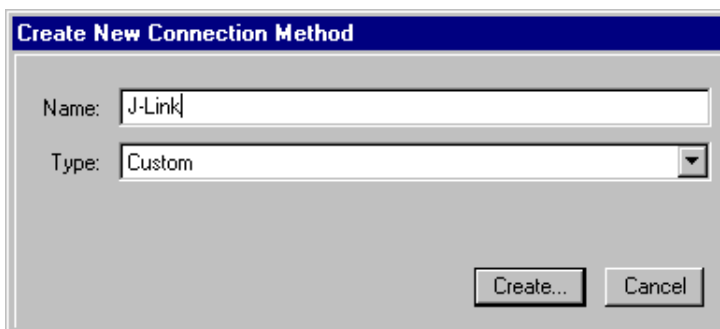

4. The **Connection Editor** dialog will be opened. Enter **rdiserv** in the **Server** field and enter the following values in the **Arguments** field:
`-config -dll <FullPathToJLinkDLLs>`
 Note that `JLinkRDI.dll` and `JLinkARM.dll` must be stored in the same directory. If the standard J-Link installation path or another path that includes spaces has been used, enclose the path in quotation marks.
 Example:
`-config -dll "C:\Program Files\SEGGER\JLinkARM_V350g\JLinkRDI.dll"`
 Refer to GHS manual "MULTI: Configuring Connections for ARM Targets", chapter "ARM Remote Debug Interface (rdiserv) Connections" for a complete list of possible arguments.

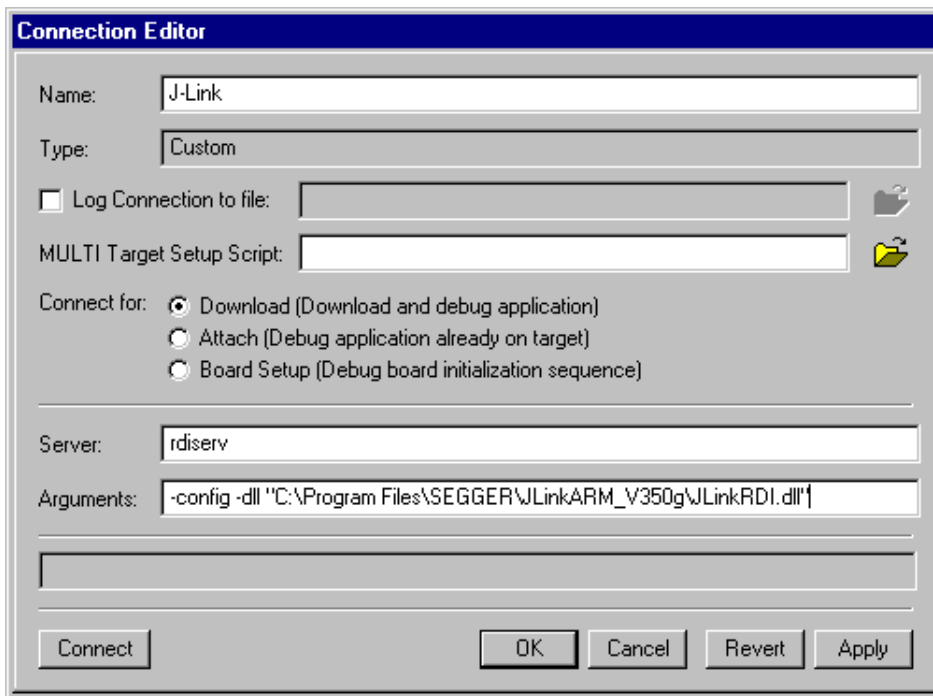

5. Confirm the choices by clicking the **Apply** button after the **Connect** button.

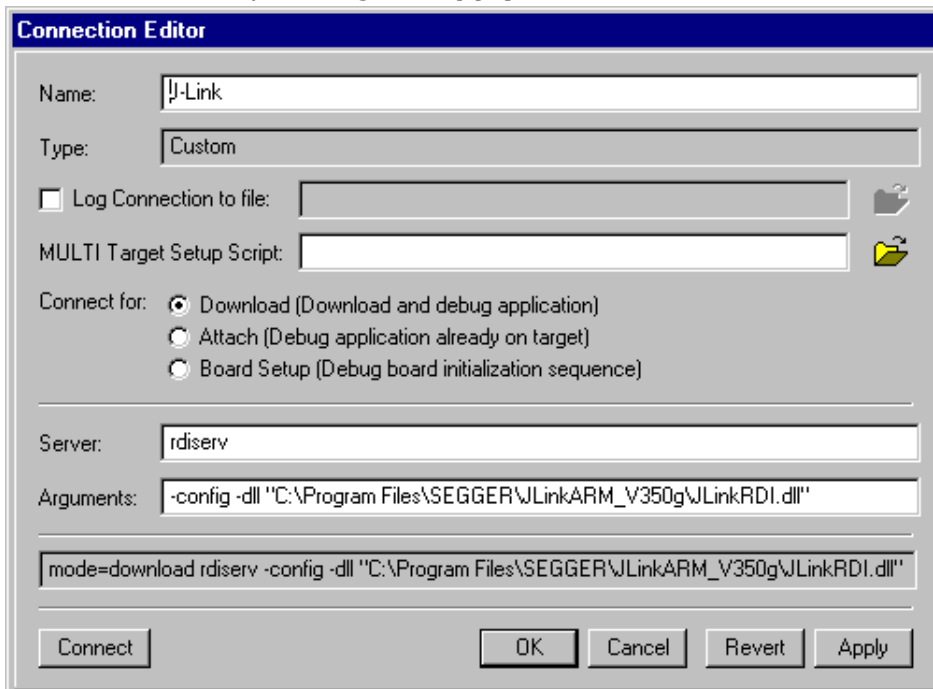

6. The **J-Link RDI Configuration** dialog will open. For more information about the generic setup of J-Link RDI, please refer to *Configuration* on page 331.
7. Click the **OK** button to connect to the target. Build the project and start the debugger. Note that at least one action (for example **step** or **run**) has to be performed in order to initiate the download of the application.

C:\Work\Basic.ghs - MULTI Debugger

```

46      /*-----*/
47      void wait ( void )
48 1     { /** Begin
49 2         unsigned int waiting_time ;
          • 0x20027c wait:          b500 PUSH (LR)
          • 0x20027e wait+0x2:    b084 SUB SP, SP, 16
50 3         change_speed () ;
          • 0x200280 wait+0x4:    f7ffffd4 BL 0xfffffa8(change_speed (0x20022c))
51 4     for(waiting_time = 0; waiting_time < LedSpeed; waiting_time++) ;
          • 0x200284 wait+0x8:    2000 MOV RO <waiting_time>, 0
          • 0x200286 wait+0xa:    e000 B 0x0(wait+0xe (0x20028a))
          • 0x200288 wait+0xc:    3001 ADD RO <waiting_time>, 1
          • 0x20028a wait+0xe:    4922 LDR R1,[PC,136](&LedSpeed (0x200314))
          • 0x20028c wait+0x10:   680b LDR R3,[R1,0]
          • 0x20028e wait+0x12:   4298 CMP RO <waiting_time>, R3
          • 0x200290 wait+0x14:   d3fa BCC 0xffffffff(wait+0xc (0x200288))
52 5     } /** End
          • 0x200292 wait+0x16:   b004 ADD SP, SP, 16
          • 0x200294 wait+0x18:   bc08 POP (R3)
          • 0x200296 wait+0x1a:   4718 BX R3
53

```

Mixed File: main.c Proc: wait

```

Finished executing setup script.
Downloading program text and data. Please Wait...
Download complete.
running 'C:\Work\Basic.ghs'
MULTI> |

```

STOPPED INSIDE

14.4 Configuration

This section describes the generic setup of J-Link RDI (same for all debuggers) using the J-Link RDI configuration dialog.

14.4.1 Configuration file JLinkRDI.ini

All settings are stored in the file `JLinkRDI.ini`. This file is located in the same directory as `JLinkRDI.dll`.

14.4.2 Using different configurations

It can be desirable to use different configurations for different targets. If this is the case, a new folder needs to be created and the `JLinkARM.dll` as well as the `JLinkRDI.dll` needs to be copied into it.

Project A needs to be configured to use `JLinkRDI.dll` A in the first folder, project B needs to be configured to use the DLL in the second folder. Both projects will use separate configuration files, stored in the same directory as the DLLs they are using.

If the debugger allows using a project-relative path (such as IAR EWARM: Use for example `$PROJ_DIR$\RDI\`), it can make sense to create the directory for the DLLs and configuration file in a subdirectory of the project.

14.4.3 Using multiple J-Links simultaneously

Same procedure as using different configurations. Each debugger session will use their own instance of the `JLinkRDI.dll`.

14.4.4 Configuration dialog

The configuration dialog consists of several tabs making the configuration of J-Link RDI very easy.

14.4.4.1 General tab



Connection to J-Link

This setting allows the user to configure how the DLL should connect to the J-Link. Some J-Link models also come with an Ethernet interface which allows to use an emulator remotely via TCP/IP connection.

License (J-Link RDI License management)

1. The **License** button opens the **J-Link RDI License management** dialog. J-Link RDI requires a valid license.

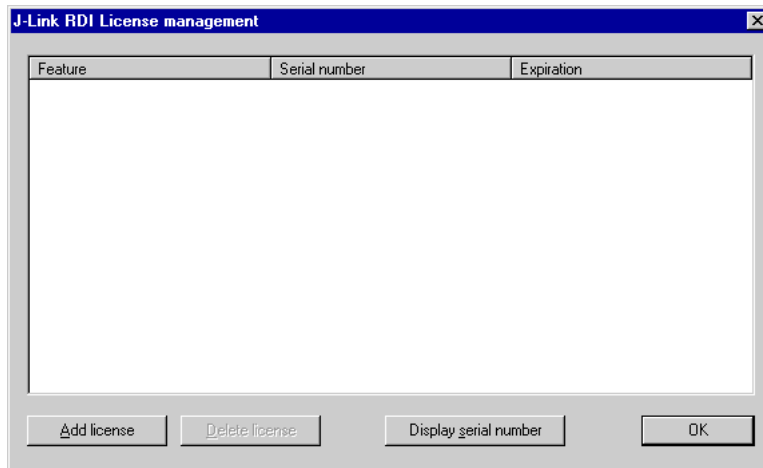

2. Click the **Add license** button and enter your license. Confirm your input by clicking the **OK** button.

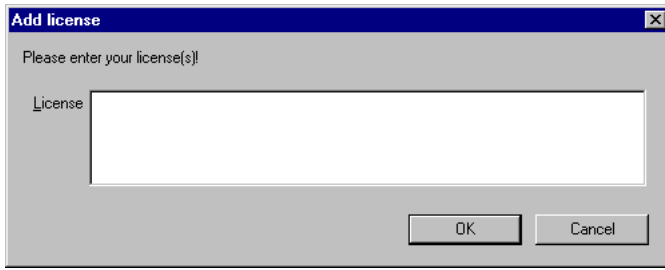

3. The J-Link RDI license is now added.

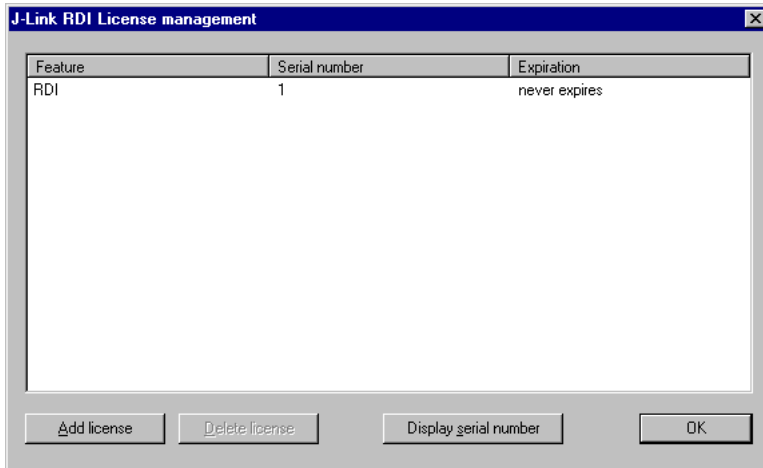

14.4.4.2 Init tab



Macro file

A macro file can be specified to load custom settings to configure J-Link RDI with advanced commands for special chips or operations. For example, a macro file can be used to initialize a target to use the PLL before the target application is downloaded, in order to speed up the download.

Commands in the macro file

Command	Description
SetJTAGSpeed (x) ;	Sets the JTAG speed, x = speed in kHz (0=Auto)

Command	Description
Delay(x);	Waits a given time, x = delay in milliseconds
Reset(x);	Resets the target, x = delay in milliseconds
Go();	Starts the ARM core
Halt();	Halts the ARM core
Read8(Addr); Read16(Addr); Read32(Addr);	Reads a 8/16/32 bit value, Addr = address to read (as hex value)
Verify8(Addr, Data); Verify16(Addr, Data); Verify32(Addr, Data);	Verifies a 8/16/32 bit value, Addr = address to verify (as hex value) Data = data to verify (as hex value)
Write8(Addr, Data); Write16(Addr, Data); Write32(Addr, Data);	Writes a 8/16/32 bit value, Addr = address to write (as hex value) Data = data to write (as hex value)
WriteVerify8(Addr, Data); WriteVerify16(Addr, Data); WriteVerify32(Addr, Data);	Writes and verifies a 8/16/32 bit value, Addr = address to write (as hex value) Data = data to write (as hex value)
WriteRegister(Reg, Data);	Writes a register
WriteJTAG_IR(Cmd);	Writes the JTAG instruction register
WriteJTAG_DR(nBits, Data);	Writes the JTAG data register

Example of macro file

```

/*****
*
*           Macro file for J-LINK RDI
*
*****
* File:     LPC2294.setup
* Purpose:  Setup for Philips LPC2294 chip
*****
*/
SetJTAGSpeed(1000);
Reset(0);
Write32(0xE01FC040, 0x00000001); // Map User Flash into Vector area at (0-3f)
Write32(0xFFE00000, 0x20003CE3); // Setup CS0
Write32(0xE002C014, 0x0E6001E4); // Setup PINSEL2 Register
SetJTAGSpeed(2000);

```

14.4.4.3 JTAG tab

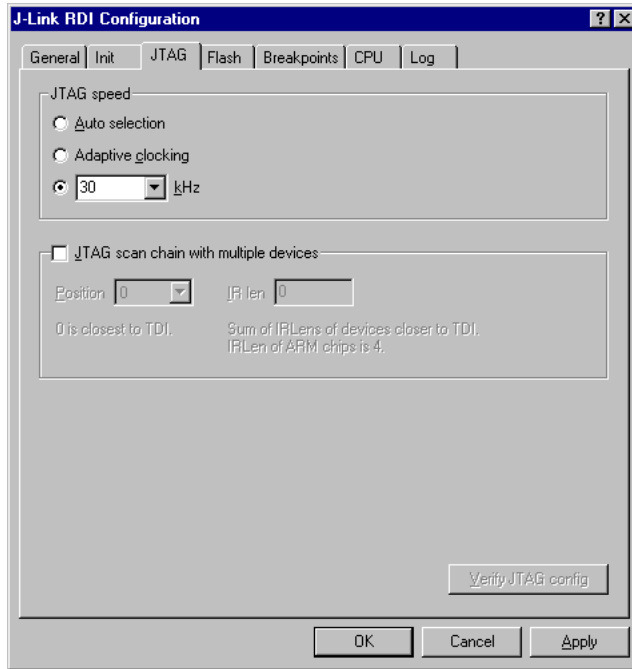

JTAG speed

This allows the selection of the JTAG speed. There are basically three types of speed settings (which are explained below):

- Fixed JTAG speed
- Automatic JTAG speed
- Adaptive clocking

JTAG scan chain with multiple devices

The JTAG scan chain allows to specify the instruction register organization of the target system. This may be needed if there are more devices located on the target system than the ARM chip you want to access or if more than one target system is connected to one J-Link at once.

14.4.4.4 Flash tab

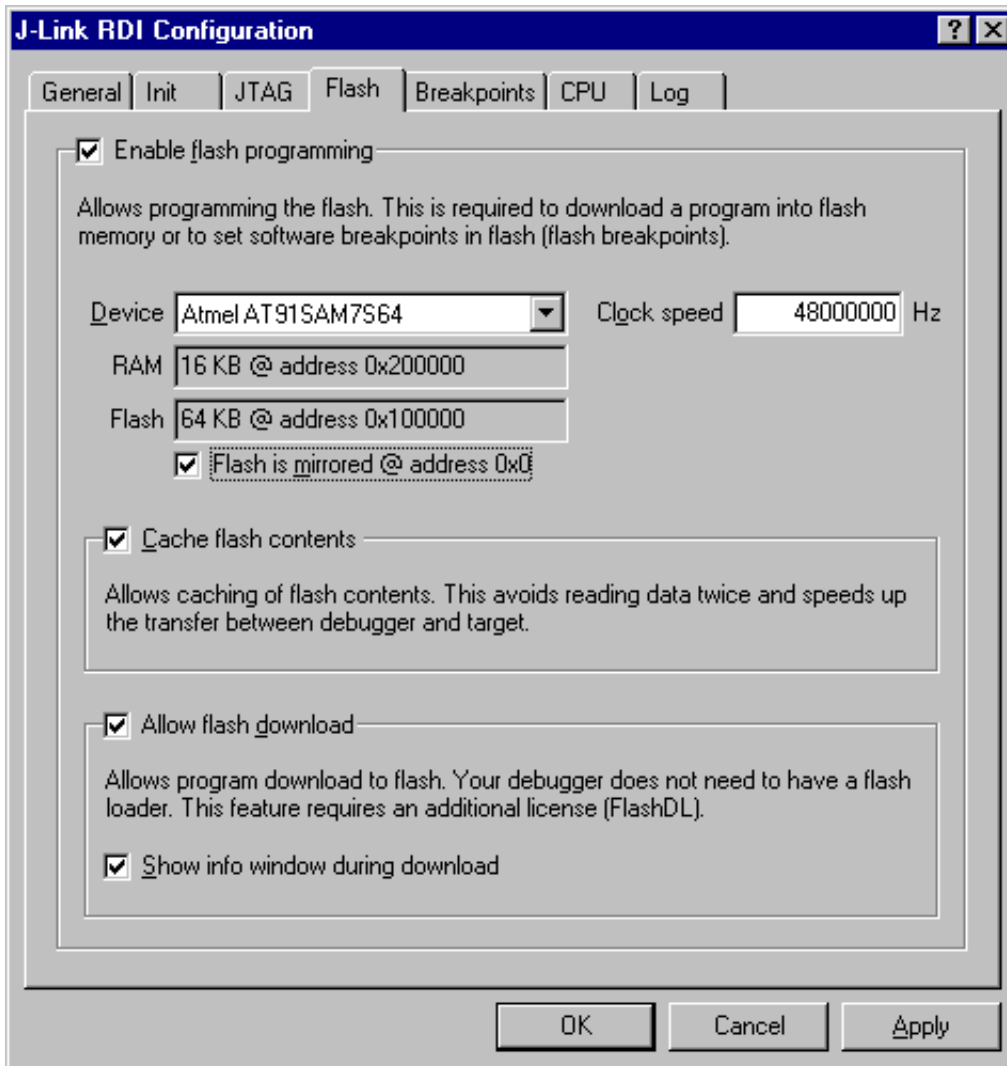

Enable flash programming

This checkbox enables flash programming. Flash programming is needed to use either flash download or flash breakpoints.

If flash programming is enabled you must select the correct flash memory and flash base address. Furthermore it is necessary for some chips to enter the correct CPU clock frequency.

Cache flash contents

If enabled, the flash content is cached by the J-Link RDI software to avoid reading data twice and to speed up the transfer between debugger and target.

Allow flash download

This allows the J-Link RDI software to download program into flash. A small piece of code will be downloaded and executed in the target RAM which then programs the flash memory. This provides flash loading abilities even for debuggers without a build-in flash loader.

An info window can be shown during download displaying the current operation. Depending on your JTAG speed you may see the info window only very short.

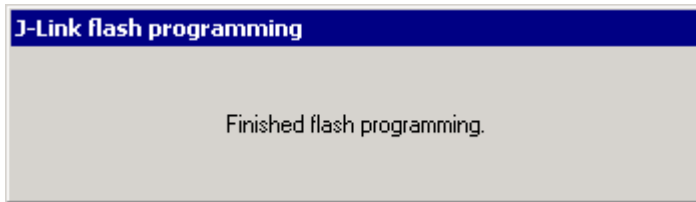

14.4.4.5 Breakpoints tab

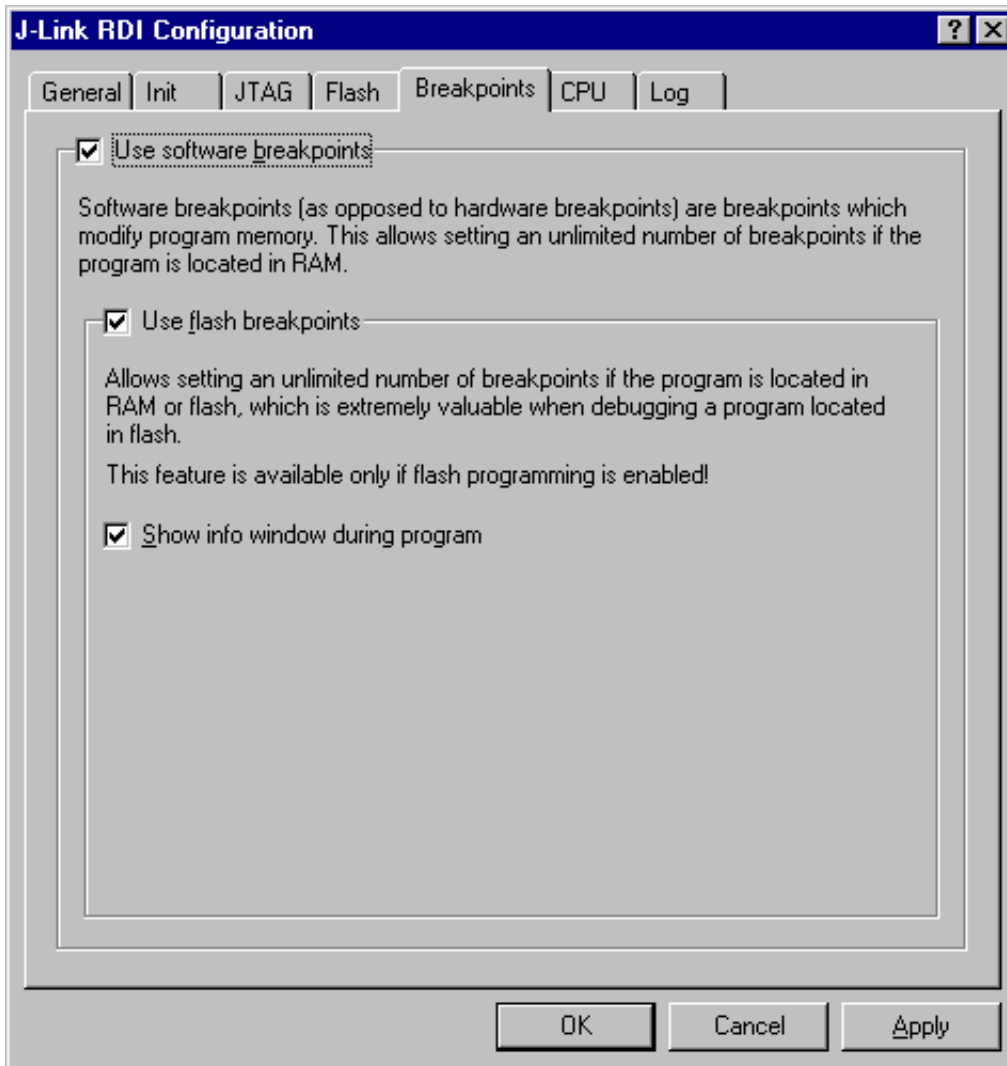

Use software breakpoints

This allows to set an unlimited number of breakpoints if the program is located in RAM by setting and resetting breakpoints according to program code.

Use flash breakpoints

This allows to set an unlimited number of breakpoints if the program is located either in RAM or in flash by setting and resetting breakpoints according to program code. An info window can be displayed while flash breakpoints are used showing the current operation. Depending on your JTAG speed the info window may hardly to be seen.

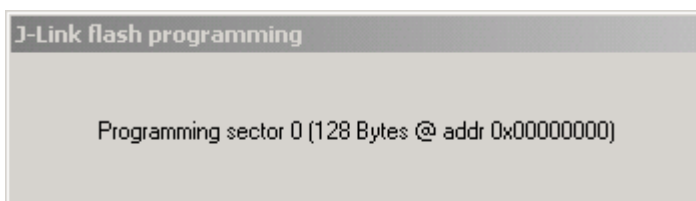

14.4.4.6 CPU tab

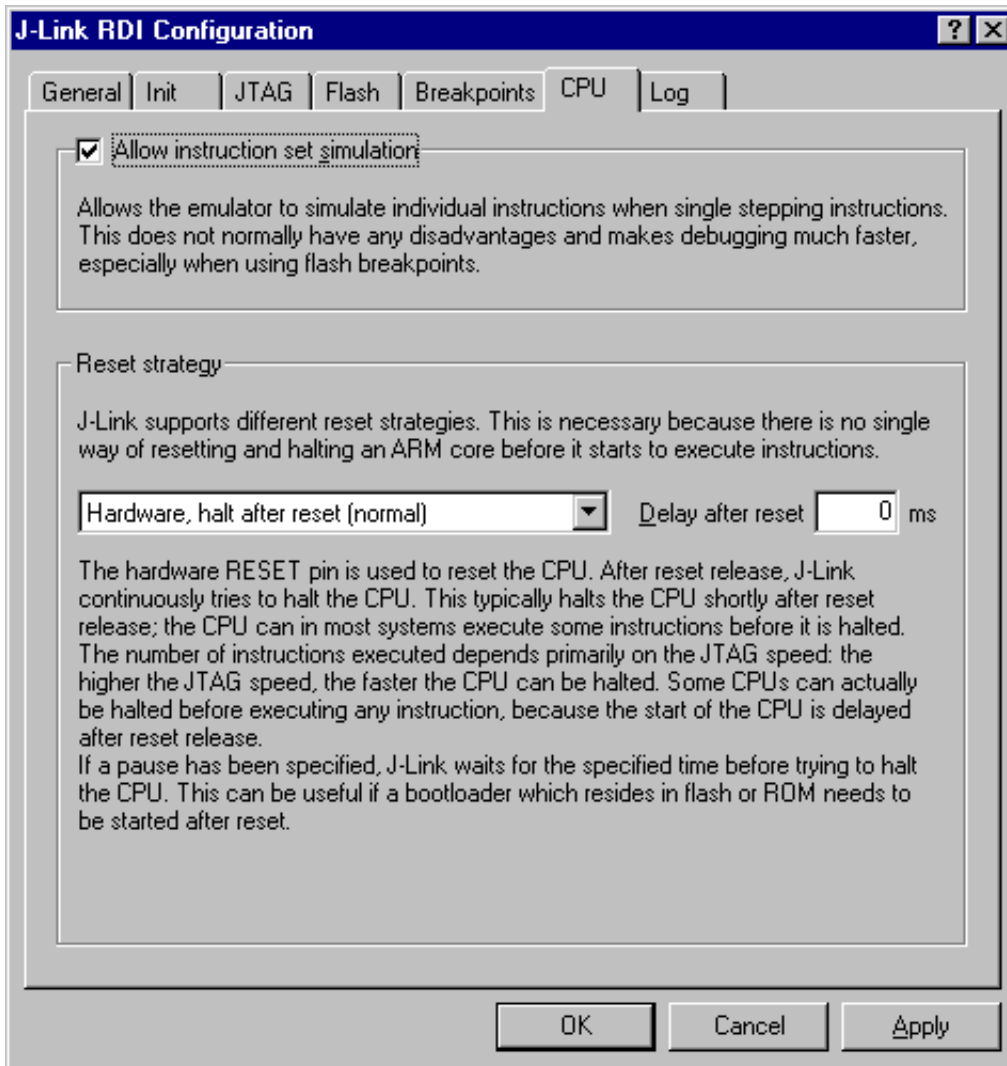

Instruction set simulation

This enables instruction set simulation which speeds up single stepping instructions especially when using flash breakpoints.

Reset strategy

This defines the way J-Link RDI should handle resets called by software. J-Link supports different reset strategies. This is necessary because there is no single way of resetting and halting an ARM core before it starts to execute instructions. For more information about the different reset strategies which are supported by J-Link and why different reset strategies are necessary, please refer to *Reset strategies*.

14.4.4.7 Log tab

A log file can be generated for the J-Link DLL and for the J-Link RDI DLL. These log files may be useful for debugging and evaluating. They may help you to solve a problem yourself, but are also needed by customer support help you.

Default path of the J-Link log file: `c:\JLinkARM.log`

Default path of the J-Link RDI log file: `c:\JLinkRDI.log`

Example of

logfile content:

```

060:028 (0000) Logging started @ 2005-10-28 07:36
060:028 (0000) DLL Compiled: Oct 4 2005 09:14:54
060:031 (0026) ARM_SetMaxSpeed - Testing speed 3F0F0F0F 3F0F0F0F 3F0F0F0F
 3F0F0F0F 3F0F0F0F 3F0F0F0F 3F0F0F0F 3F0F0F0F 3F0F0F0F 3F0F0F0F 3F0F0F0F
 3F0F0F0FAuto JTAG speed: 4000 kHz
060:059 (0000) ARM_SetEndian(ARM_ENDIAN_LITTLE)
060:060 (0000) ARM_SetEndian(ARM_ENDIAN_LITTLE)
060:060 (0000) ARM_ResetPullsRESET(ON)
060:060 (0116) ARM_Reset(): SpeedIsFixed == 0 -> JTAGSpeed = 30kHz >48> >2EF>
060:176 (0000) ARM_WriteIceReg(0x02,00000000)
060:177 (0016) ARM_WriteMem(FFFFFFC20,0004) -- Data: 01 06 00 00 - Writing 0x4
 bytes @ 0xFFFFFC20 >1D7>
060:194 (0014) ARM_WriteMem(FFFFFFC2C,0004) -- Data: 05 1C 19 00 - Writing 0x4
 bytes @ 0xFFFFFC2C >195>
060:208 (0015) ARM_WriteMem(FFFFFFC30,0004) -- Data: 07 00 00 00 - Writing 0x4
 bytes @ 0xFFFFFC30 >195>
060:223 (0002) ARM_ReadMem (00000000,0004)JTAG speed: 4000 kHz -- Data: 0C 00 00
 EA
060:225 (0001) ARM_WriteMem(00000000,0004) -- Data: 0D 00 00 EA - Writing 0x4
 bytes @ 0x00000000 >195>
060:226 (0001) ARM_ReadMem (00000000,0004) -- Data: 0C 00 00 EA
060:227 (0001) ARM_WriteMem(FFFFFFF00,0004) -- Data: 01 00 00 00 - Writing 0x4
 bytes @ 0xFFFFF00 >195>
060:228 (0001) ARM_ReadMem (FFFFFF240,0004) -- Data: 40 05 09 27
060:229 (0001) ARM_ReadMem (FFFFFF244,0004) -- Data: 00 00 00 00
060:230 (0001) ARM_ReadMem (FFFFFFF6C,0004) -- Data: 10 01 00 00
060:232 (0000) ARM_WriteMem(FFFFFF124,0004) -- Data: FF FF FF FF - Writing 0x4
 bytes @ 0xFFFFF124 >195>
060:232 (0001) ARM_ReadMem (FFFFFF130,0004) -- Data: 00 00 00 00
060:233 (0001) ARM_ReadMem (FFFFFF130,0004) -- Data: 00 00 00 00
060:234 (0001) ARM_ReadMem (FFFFFF130,0004) -- Data: 00 00 00 00
060:236 (0000) ARM_ReadMem (FFFFFF130,0004) -- Data: 00 00 00 00
060:237 (0000) ARM_ReadMem (FFFFFF130,0004) -- Data: 00 00 00 00
060:238 (0001) ARM_ReadMem (FFFFFF130,0004) -- Data: 00 00 00 00
060:239 (0001) ARM_ReadMem (FFFFFF130,0004) -- Data: 00 00 00 00
060:240 (0001) ARM_ReadMem (FFFFFF130,0004) -- Data: 00 00 00 00
060:241 (0001) ARM_WriteMem(FFFFFFD44,0004) -- Data: 00 80 00 00 - Writing 0x4
 bytes @ 0xFFFFD44 >195>
060:277 (0000) ARM_WriteMem(00000000,0178) -- Data: 0F 00 00 EA FE FF FF EA ...
060:277 (0000) ARM_WriteMem(000003C4,0020) -- Data: 01 00 00 00 02 00 00 00 ... -
 Writing 0x178 bytes @ 0x00000000
060:277 (0000) ARM_WriteMem(000001CC,00F4) -- Data: 30 B5 15 48 01 68 82 68 ... -
 Writing 0x20 bytes @ 0x000003C4
060:277 (0000) ARM_WriteMem(000002C0,0002) -- Data: 00 47
060:278 (0000) ARM_WriteMem(000002C4,0068) -- Data: F0 B5 00 27 24 4C 34 4D ... -
 Writing 0xF6 bytes @ 0x000001CC
060:278 (0000) ARM_WriteMem(0000032C,0002) -- Data: 00 47
060:278 (0000) ARM_WriteMem(00000330,0074) -- Data: 30 B5 00 24 A0 00 08 49 ... -
 Writing 0x6A bytes @ 0x000002C4
060:278 (0000) ARM_WriteMem(000003B0,0014) -- Data: 00 00 00 00 0A 00 00 00 ... -
 Writing 0x74 bytes @ 0x00000330
060:278 (0000) ARM_WriteMem(000003A4,000C) -- Data: 14 00 00 00 E4 03 00 00 ... -
 Writing 0x14 bytes @ 0x000003B0
060:278 (0000) ARM_WriteMem(00000178,0054) -- Data: 12 4A 13 48 70 B4 81 B0 ... -
 Writing 0xC bytes @ 0x000003A4
060:278 (0000) ARM_SetEndian(ARM_ENDIAN_LITTLE)
060:278 (0000) ARM_SetEndian(ARM_ENDIAN_LITTLE)
060:278 (0000) ARM_ResetPullsRESET(OFF)
060:278 (0009) ARM_Reset(): - Writing 0x54 bytes @ 0x00000178 >3E68>
060:287 (0001) ARM_Halt(): **** Warning: Chip has already been halted.
...

```

14.5 Semihosting

Semihosting can be used with J-Link RDI. For more information how to enable semihosting in J-Link RDI, please refer to *Enabling Semihosting in J-Link RDI + AXD* .

14.5.1 Unexpected / unhandled SWIs

When an unhandled SWI is detected by J-Link RDI, the message box below is shown.

Chapter 15

ARM SWD specifics

15.1 Introduction

Serial Wire Debug (SWD) is a debug interface specified by ARM, as a low pin count (2: SWCLK, SWDIO) alternative to the traditional 4-wire JTAG (IEEE 1149.1) debug interface. It was released before 2-wire cJTAG (IEEE 1149.7) was released. This chapter explains SWD specifics that do not apply for other debug interfaces.

15.2 SWD multi-drop

By default, SWD was designed as a point-to-point protocol where only one device is connected to J-Link at the same time. With the SWD V2 specification, ARM introduced support for SWD multi-drop which allows (similar to JTAG) having multiple devices sharing the same debug signals (SWCLK and SWDIO) and so allow to address many devices on the same PCB with just one debug connector.

Note

Not all devices that support SWD also support multi-drop. This requires SWDv2 compatibility. For more information about if a specific device supports multi-drop, please refer to the technical reference manual of the specific device

15.2.1 How it works

The different devices on the multi-drop bus are identified by a combination of their <DeviceID> and a so-called <InstanceID>. While the <DeviceID> is fixed per device, the <InstanceID> is usually determined by a device via certain GPIOs being sampled at boot time (please refer to the technical reference manual of the specific device for more information about how to determine its <InstanceID>).

By default, all devices on the SWD multi-drop bus are active (to be backward compatible in case only a single device is mounted on the PCB) and would all respond to commands being received.

On debug session start, J-Link will send a special sequence that contains the <DeviceID> and <InstanceID> which makes sure that only the affected device is selected and all other ones enter a listening state where they do not respond on the bus anymore but still listen for a wake-up sequence containing their ID pair. From there on, only the selected device is responsive and can be debugged.

15.2.2 Setting up SWD multi-drop in the J-Link software

In order to select a specific device on the multi-drop bus, J-Link needs to know the <DeviceID> and <InstanceID> of the device to communicate with. This ID pair can be passed to J-Link via *J-Link Script files*. The J-Link script needs to implement the *ConfigTargetSettings* function and provide the following contents:

```
int ConfigTargetSettings(void) {
    JLINK_ExecCommand("SetSWDTargetId=0x01234567"); // 28-bit target ID
    JLINK_ExecCommand("SetSWDInstanceId=0x8");      // 4-bit instance ID
    return 0;
}
```

15.2.3 J-Link support

SWD multi-drop needs to be supported by the J-Link hardware in use. For an overview about which models and hardware versions support SWD multi-drop, please refer to the SEGGER wiki: [J-Link hardware features overview](#)

Chapter 16

RTT

SEGGER's Real Time Transfer (RTT) is a technology for interactive user I/O in embedded applications. It combines the advantages of SWO and semihosting at very high performance.

16.1 Introduction

With RTT it is possible to output information from the target microcontroller as well as sending input to the application at a very high speed without affecting the target's real time behavior.

SEGGER RTT can be used with any J-Link model and any supported target processor which allows background memory access, which are Cortex-M and RX targets.

RTT supports multiple channels in both directions, up to the host and down to the target, which can be used for different purposes and provide the most possible freedom to the user.

The default implementation uses one channel per direction, which are meant for printable terminal input and output. With the J-Link RTT Viewer this channel can be used for multiple "virtual" terminals, allowing to print to multiple windows (e.g. one for standard output, one for error output, one for debugging output) with just one target buffer. An additional up (to host) channel can for example be used to send profiling or event tracing data.

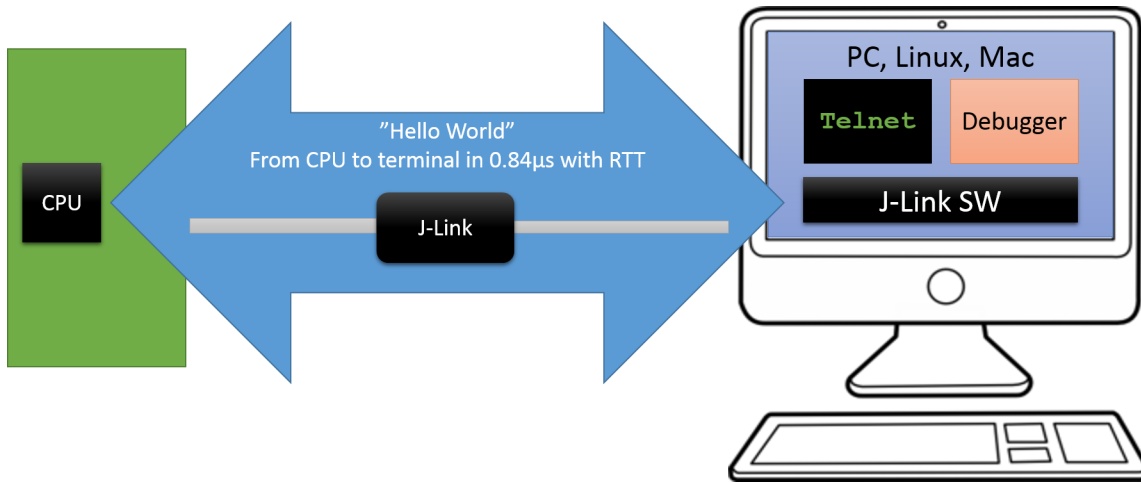

16.2 How RTT works

16.2.1 Target implementation

Real Time Transfer uses a SEGGER RTT Control Block structure in the target's memory to manage data reads and writes. The control block contains an ID to make it findable in memory by a connected J-Link and a ring buffer structure for each available channel, describing the channel buffer and its state. The maximum number of available channels can be configured at compile time and each buffer can be configured and added by the application at run time. Up and down buffers can be handled separately. Each channel can be configured to be blocking or non-blocking. In blocking mode the application will wait when the buffer is full, until all memory could be written, resulting in a blocked application state but preventing data from getting lost. In non-blocking mode only data which fits into the buffer, or none at all, will be written and the rest will be discarded. This allows running in real-time, even when no debugger is connected. The developer does not have to create a special debug version and the code can stay in place in a release application.

16.2.2 Locating the Control Block

When RTT is active on the host computer, either by using RTT directly via an application like RTT Viewer or by connecting via Telnet to an application which is using J-Link, like a debugger, J-Link automatically searches for the SEGGER RTT Control Block in the target's known RAM regions. The RAM regions or the specific address of the Control Block can also be set via the host applications to speed up detection or if the block cannot be found automatically.

16.2.2.1 Manual specification of the Control Block location

While auto-detection of the RTT control block location works fine for most targets, it is always possible to manually specify either the exact location of the control block or to specify a certain address range J-Link shall search for a control block for in. This is done via the following J-Link Command Strings:

- *SetRTTAddr*
- *SetRTTSearchRanges*

For more information about how to use J-Link Command Strings in various environments, please refer to *Using J-Link Command Strings*

16.2.3 Internal structures

There may be any number of "Up Buffer Descriptors" (Target -> Host), as well as any number of "Down Buffer Descriptors" (Host -> Target). Each buffer size can be configured individually.

The gray areas in the buffers are the areas that contain valid data.

For Up buffers, the Write Pointer is written by the target, the Read Pointer is written by the debug probe (J-Link, Host).

When Read and Write Pointers point to the same element, the buffer is empty. This assures there is never a race condition. The image shows the simplified structure in the target.

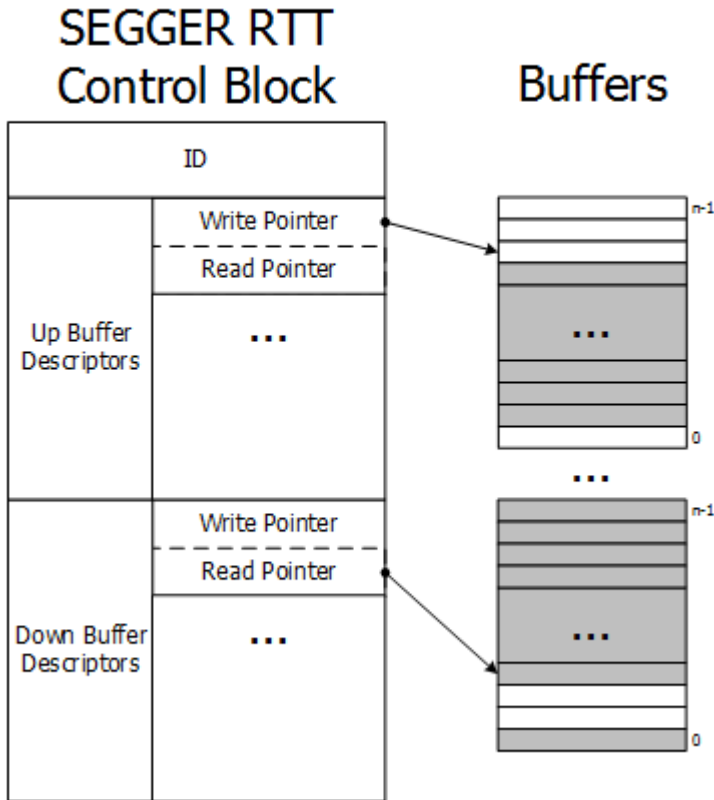

16.2.4 Requirements

SEGGER RTT does not need any additional pin or hardware, despite a J-Link connected via the standard debug port to the target. It does not require any configuration of the target or in the debugging environment and can even be used with varying target speeds. RTT can be used in parallel to a running debug session, without intrusion, as well as without any IDE or debugger at all.

16.2.5 Performance

The performance of SEGGER RTT is significantly higher than any other technology used to output data to a host PC. An average line of text can be output in one microsecond or less. Basically only the time to do a single memcpy().

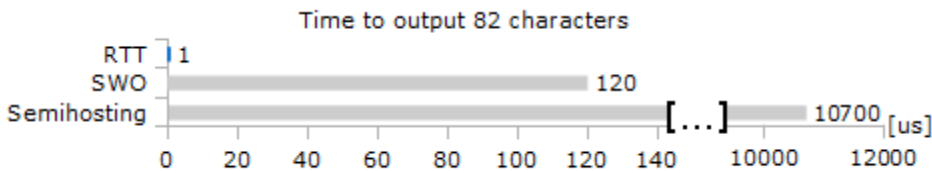

16.2.6 Memory footprint

The RTT implementation code uses ~500 Bytes of ROM and 24 Bytes ID + 24 Bytes per channel for the control block in RAM. Each channel requires some memory for the buffer. The recommended sizes are 1 kByte for up channels and 16 to 32 Bytes for down channels depending on the load of in- / output.

16.3 RTT Communication

Communication with the RTT implementation on the target can be done with different applications. The functionality can even be integrated into custom applications using the J-Link SDK.

Using RTT in the target application is made easy. The implementation code is freely available for download and can be integrated into any existing application. To communicate via RTT any J-Link can be used.

The simple way to communicate via the Terminal (Channel 0) is to create a connection to localhost:19021 with a Telnet client or similar, when a connection to J-Link (e.g. via a debug session) is active.

The J-Link Software Package comes with some more advanced applications, which demonstrates RTT functionality for different purposes.

16.3.1 RTT Viewer

The J-Link RTT Viewer is described in [J-Link RTT Viewer](#) .

16.3.2 RTT Client

J-Link RTT Client acts as a Telnet client, but automatically tries to reconnect to a J-Link connection when a debug session is closed.

The J-Link RTT Client is part of the J-Link Software and Documentation Pack for Windows, Linux and OS X and can be used for simple RTT use cases.

Command line options:

Command	Explanation
-?	Shows commandline options
-LocalEcho	1 = Enables - / 0 = Disables local echo
-rtttelnetport <Port>	Sets the RTT telnet port to <Port>

16.3.3 RTT Logger

With J-Link RTT Logger, data from Up-Channel 1 can be read and logged to a file. This channel can for example be used to send performance analysis data to the host.

J-Link RTT Logger opens a dedicated connection to J-Link and can be used stand-alone, without running a debugger.

The application is part of the J-Link Software and Documentation Pack for Windows, Linux and OS X.

The source of J-Link RTT Logger can be used as a starting point to integrate RTT in other PC applications, like debuggers, and is part of the J-Link SDK.

Command line options:

Command	Explanation
-?	Shows commandline options
-Device <DeviceName>	Sets target device to <DeviceName>
-if <Interface>	Sets target interface to <Interface>
-Speed <SpeedInKHZ>	Sets speed to <SpeedInKHZ>
-SelectEmuBySN <SN>	Connects to J-Link with serial numbet <SN> via USB
-RTTAddress <RTTAddress>	Sets RTT address to <RTTAddress>
-RTTChannel <RTTChannel>	Sets RTT channel to <RTTChannel>

16.3.4 RTT in other host applications

RTT can also be integrated in any other PC application like a debugger or a data visualizer in either of two ways.

- The application can establish a socket connection to the RTT Telnet Server which is opened on localhost:19021 when a J-Link connection is active.
- The application creates its own connection to J-Link and uses the J-Link RTT API which is part of the J-Link SDK to directly configure and use RTT.

16.4 Implementation

The SEGGER RTT implementation code is written in ANSI C and can be integrated into any embedded application by simply adding the available sources.

RTT can be used via a simple and easy to use API. It is even possible to override the standard printf() functions to be used with RTT. Using RTT reduces the time taken for output to a minimum and allows printing debug information to the host computer while the application is performing time critical real time tasks.

The implementation code also includes a simple version of printf() which can be used to write formatted strings via RTT. It is smaller than most standard library printf() implementations and does not require heap and only a configurable amount of stack.

The SEGGER RTT implementation is fully configurable at compile time with pre-processor defines. The number of channels, the size of the default channels can be set. Reading and writing can be made task-safe with definable Lock() and Unlock() routines.

16.4.1 API functions

The following API functions are available in the RTT Implementation. To use them SEGGER_RTT.h has to be included in the calling sources.

API functions
SEGGER_RTT_ConfigDownBuffer()
SEGGER_RTT_ConfigUpBuffer()
SEGGER_RTT_GetKey()
SEGGER_RTT_HasKey()
SEGGER_RTT_Init()
SEGGER_RTT_printf()
SEGGER_RTT_Read()
SEGGER_RTT_SetTerminal()
SEGGER_RTT_TerminalOut()
SEGGER_RTT_WaitKey()
SEGGER_RTT_Write()
SEGGER_RTT_WriteString()

16.4.1.1 SEGGER_RTT_ConfigDownBuffer()

Configure or add a down buffer by specifying its name, size and flags.

Syntax

```
int SEGGER_RTT_ConfigDownBuffer (unsigned BufferIndex, const char* sName,
char* pBuffer, int BufferSize, int Flags);
```

Parameter	Meaning
BufferIndex	Index of the buffer to configure. Must be lower than SEGGER_RTT_MAX_NUM_DOWN_CHANNELS.
sName	Pointer to a 0-terminated string to be displayed as the name of the channel.
pBuffer	Pointer to a buffer used by the channel.
BufferSize	Size of the buffer in Bytes.
Flags	Flags of the channel (blocking or non-blocking).

Return value

Value	Meaning
≥ 0	O.K.
< 0	Error

Example

```
//
// Configure down channel 1
//
SEGGER_RTT_ConfigDownChannel(1, "DataIn", &abDataIn[0], sizeof(abDataIn),
                             SEGGER_RTT_MODE_NO_BLOCK_SKIP);
```

Additional information

Once a channel is configured only the flags of the channel should be changed.

16.4.1.2 SEGGER_RTT_ConfigUpBuffer()

Configure or add an up buffer by specifying its name, size and flags.

Syntax

```
int SEGGER_RTT_ConfigUpBuffer (unsigned BufferIndex, const char* sName, char*
pBuffer, int BufferSize, int Flags);
```

Parameter	Meaning
<code>BufferIndex</code>	Index of the buffer to configure. Must be lower than <code>SEGGER_RTT_MAX_NUM_UP_CHANNELS</code> .
<code>sName</code>	Pointer to a 0-terminated string to be displayed as the name of the channel.
<code>pBuffer</code>	Pointer to a buffer used by the channel.
<code>BufferSize</code>	Size of the buffer in Bytes.
<code>Flags</code>	Flags of the channel (blocking or non-blocking).

Return value

Value	Meaning
≥ 0	O.K.
< 0	Error

Example

```
//
// Configure up channel 1 to work in blocking mode
//
SEGGER_RTT_ConfigUpChannel(1, "DataOut", &abDataOut[0], sizeof(abDataOut),
                           SEGGER_RTT_MODE_BLOCK_IF_FIFO_FULL);
```

Additional information

Once a channel is configured only the flags of the channel should be changed.

16.4.1.3 SEGGER_RTT_GetKey()

Reads one character from SEGGER RTT buffer 0. Host has previously stored data there.

Syntax

```
int SEGGER_RTT_GetKey (void);
```

Return value

Value	Meaning
≥ 0	Character which has been read (0 - 255).
< 0	No character available (empty buffer).

Example

```
int c;
c = SEGGER_RTT_GetKey();
if (c == 'q') {
    exit();
}
```

16.4.1.4 SEGGER_RTT_HasKey()

Checks if at least one character for reading is available in SEGGER RTT buffer.

Syntax

```
int SEGGER_RTT_HasKey (void);
```

Return value

Value	Meaning
1	At least one character is available in the buffer.
0	No characters are available to be read.

Example

```
if (SEGGER_RTT_HasKey()) {
    int c = SEGGER_RTT_GetKey();
}
```

16.4.1.5 SEGGER_RTT_Init()

Initializes the RTT Control Block.

Syntax

```
void SEGGER_RTT_Init (void);
```

Additional information

Should be used in RAM targets, at start of the application.

16.4.1.6 SEGGER_RTT_printf()

Send a formatted string to the host.

Syntax

```
int SEGGER_RTT_printf (unsigned BufferIndex, const char * sFormat, ...)
```

Parameter	Meaning
BufferIndex	Index of the up channel to sent the string to.
sFormat	Pointer to format string, followed by arguments for conversion.

Return value

Value	Meaning
≥ 0	Number of bytes which have been sent.
< 0	Error.

Example

```
SEGGER_RTT_printf(0, "SEGGER RTT Sample. Uptime: %.10dms.", /*OS_Time*/ 890912);
// Formatted output on channel 0: SEGGER RTT Sample. Uptime: 890912ms.
```

Additional information

(1) Conversion specifications have following syntax:

- %[flags][FieldWidth][.Precision]ConversionSpecifier

(2) Supported flags:

- -: Left justify within the field width
- +: Always print sign extension for signed conversions
- 0: Pad with 0 instead of spaces. Ignored when using '-'-flag or precision

(3) Supported conversion specifiers:

- c: Print the argument as one char
- d: Print the argument as a signed integer
- u: Print the argument as an unsigned integer
- x: Print the argument as an hexadecimal integer
- s: Print the string pointed to by the argument
- p: Print the argument as an 8-digit hexadecimal integer. (Argument shall be a pointer to void.)

16.4.1.7 SEGGER_RTT_Read()

Read characters from any RTT down channel which have been previously stored by the host.

Syntax

```
unsigned SEGGER_RTT_Read (unsigned BufferIndex, char* pBuffer, unsigned BufferSize);
```

Parameter	Meaning
BufferIndex	Index of the down channel to read from.
pBuffer	Pointer to a character buffer to store the read characters.
BufferSize	Number of bytes available in the buffer.

Return value

Value	Meaning
≥ 0	Number of bytes that have been read.

Example

```
char acIn[4];
unsigned NumBytes = sizeof(acIn);
NumBytes = SEGGER_RTT_Read(0, &acIn[0], NumBytes);
if (NumBytes) {
    AnalyzeInput(acIn);
}
```

16.4.1.8 SEGGER_RTT_SetTerminal()

Set the “virtual” terminal to send following data on channel 0.

Syntax

```
void SEGGER_RTT_SetTerminal(char TerminalId);
```

Parameter	Meaning
TerminalId	Id of the virtual terminal (0-9).

Example

```
//
// Send a string to terminal 1 which is used as error out.
//
SEGGER_RTT_SetTerminal(1); // Select terminal 1
SEGGER_RTT_WriteString(0, "ERROR: Buffer overflow");
SEGGER_RTT_SetTerminal(0); // Reset to standard terminal
```

Additional information

All following data which is sent via channel 0 will be printed on the set terminal until the next change.

16.4.1.9 SEGGER_RTT_TerminalOut()

Send one string to a specific “virtual” terminal.

Syntax

```
int SEGGER_RTT_TerminalOut (char TerminalID, const char* s);
```

Parameter	Meaning
TerminalId	Id of the virtual terminal (0-9).
s	Pointer to 0-terminated string to be sent.

Return value

Value	Meaning
≥ 0	Number of bytes sent to the terminal.
< 0	Error

Example

```
//
// Sent a string to terminal 1 without changing the standard terminal.
//
SEGGER_RTT_TerminalOut(1, "ERROR: Buffer overflow.");
```

Additional information

SEGGER_RTT_TerminalOut does not affect following data which is sent via channel 0.

16.4.1.10 SEGGER_RTT_Write()

Send data to the host on an RTT channel.

Syntax

```
unsigned SEGGER_RTT_Write (unsigned BufferIndex, const char* pBuffer, unsigned NumBytes);
```

Parameter	Meaning
<code>BufferIndex</code>	Index of the up channel to send data to.
<code>pBuffer</code>	Pointer to data to be sent.
<code>NumBytes</code>	Number of bytes to send.

Return value

Value	Meaning
≥ 0	Number of bytes which have been sent

Additional information

With `SEGGER_RTT_Write()` all kinds of data, not only printable one can be sent.

16.4.1.11 SEGGER_RTT_WaitKey()

Waits until at least one character is available in SEGGER RTT buffer 0. Once a character is available, it is read and returned.

Syntax

```
int SEGGER_RTT_WaitKey (void);
```

Return value

Value	Meaning
≥ 0	Character which has been read (0 - 255).

Example

```
int c = 0;
do {
    c = SEGGER_RTT_WaitKey();
} while (c != 'c');
```

16.4.1.12 SEGGER_RTT_WriteString()

Write a 0-terminated string to an up channel via RTT.

Syntax

```
unsigned SEGGER_RTT_WriteString (unsigned BufferIndex, const char* s);
```

Parameter	Meaning
<code>BufferIndex</code>	Index of the up channel to send string to.
<code>s</code>	Pointer to 0-terminated string to be sent.

Return value

Value	Meaning
≥ 0	Number of bytes which have been sent.

Example

```
SEGGER_RTT_WriteString(0, "Hello World from your target.\n");
```

16.4.2 Configuration defines

16.4.2.1 RTT configuration

SEGGER_RTT_MAX_NUM_DOWN_BUFFERS

Maximum number of down (to target) channels.

SEGGER_RTT_MAX_NUM_UP_BUFFERS

Maximum number of up (to host) channels.

BUFFER_SIZE_DOWN

Size of the buffer for default down channel 0.

BUFFER_SIZE_UP

Size of the buffer for default up channel 0.

SEGGER_RTT_PRINT_BUFFER_SIZE

Size of the buffer for SEGGER_RTT_printf to bulk-send chars.

SEGGER_RTT_LOCK()

Locking routine to prevent interrupts and task switches from within an RTT operation.

SEGGER_RTT_UNLOCK()

Unlocking routine to allow interrupts and task switches after an RTT operation.

SEGGER_RTT_IN_RAM

Indicate the whole application is in RAM to prevent falsely identifying the RTT Control Block in the init segment by defining as 1.

16.4.2.2 Channel buffer configuration

SEGGER_RTT_MODE_BLOCK_IF_FIFO_FULL

A call to a writing function will block, if the up buffer is full.

SEGGER_RTT_MODE_NO_BLOCK_SKIP

If the up buffer has not enough space to hold all of the incoming data, nothing is written to the buffer.

SEGGER_RTT_MODE_NO_BLOCK_TRIM

If the up buffer has not enough space to hold all of the incoming data, the available space is filled up with the incoming data while discarding any excess data.

Note

SEGGER_RTT_TerminalOut ensures that implicit terminal switching commands are always sent out, even while using the non-blocking modes.

16.4.2.3 Color control sequences

RTT_CTRL_RESET

Reset the text color and background color.

RTT_CTRL_TEXT_*

Set the text color to one of the following colors.

- BLACK
- RED
- GREEN
- YELLOW
- BLUE
- MAGENTA
- CYAN
- WHITE (light grey)
- BRIGHT_BLACK (dark grey)
- BRIGHT_RED
- BRIGHT_GREEN
- BRIGHT_YELLOW
- BRIGHT_BLUE
- BRIGHT_MAGENTA
- BRIGHT_CYAN
- BRIGHT_WHITE

RTT_CTRL_BG_*

Set the background color to one of the following colors.

- BLACK
- RED
- GREEN
- YELLOW
- BLUE
- MAGENTA
- CYAN
- WHITE (light grey)
- BRIGHT_BLACK (dark grey)
- BRIGHT_RED
- BRIGHT_GREEN
- BRIGHT_YELLOW
- BRIGHT_BLUE
- BRIGHT_MAGENTA
- BRIGHT_CYAN
- BRIGHT_WHITE

16.5 ARM Cortex - Background memory access

On ARM Cortex targets, background memory access necessary for RTT is performed via a so-called AHB-AP which is similar to a DMA but exclusively accessible by the debug probe. While on Cortex-M targets there is always an AHB-AP present, on Cortex-A and Cortex-R targets this is an optional component. CortexA/R targets may implement multiple APs (some even not an AHB-AP at all), so in order to use RTT on Cortex-A/R targets, the index of the AP which is the AHB-AP that shall be used for RTT background memory access, needs to be manually specified.

This is done via the following J-Link Command string: *CORESIGHT_SetIndexAHBAPToUse* . For more information about how to use J-Link Command Strings in various environments, please refer to *Using J-Link Command Strings* .

16.6 Example code

```

/*****
 *                               *
 *      SEGGER Microcontroller GmbH *
 *      Solutions for real time microcontroller applications *
 *****/
 *                               *
 *      (c) 1995 - 2018 SEGGER Microcontroller GmbH *
 *                               *
 *      www.segger.com Support: support@segger.com *
 *                               *
 *****/

-----
File      : RTT.c
Purpose  : Simple implementation for output via RTT.
It can be used with any IDE.
----- END-OF-HEADER -----
*/

#include "SEGGER_RTT.h"

static void _Delay(int period) {
    int i = 10000*period;
    do { ; } while (i--);
}

int main(void) {
    int Cnt = 0;

    SEGGER_RTT_WriteString(0, "Hello World from SEGGER!\n");
    do {
        SEGGER_RTT_printf("%sCounter: %s%d\n",
            RTT_CTRL_TEXT_BRIGHT_WHITE,
            RTT_CTRL_TEXT_BRIGHT_GREEN,
            Cnt);
        if (Cnt > 100) {
            SEGGER_RTT_TerminalOut(1, RTT_CTRL_TEXT_BRIGHT_RED"Counter overflow!");
            Cnt = 0;
        }
        _Delay(100);
        Cnt++;
    } while (1);
    return 0;
}

/***** End of file *****/

```

16.7 FAQ

Q: How does J-Link find the RTT buffer?

A: There are two ways: If the debugger (IDE) knows the address of the SEGGER RTT Control Block, it can pass it to J-Link. This is for example done by J-Link Debugger. If another application that is not SEGGER RTT aware is used, then J-Link searches for the ID in the known target RAM during execution of the application in the background. This process normally takes just fractions of a second and does not delay program execution.

Q: I am debugging a RAM-only application. J-Link finds an RTT buffer, but I get no output. What can I do?

A: In case the init section of an application is stored in RAM, J-Link might falsely identify the block in the init section instead of the actual one in the data section. To prevent this, set the define `SEGGER_RTT_IN_RAM` to 1. Now J-Link will find the correct RTT buffer, but only after calling the first `SEGGER_RTT` function in the application. A call to `SEGGER_RTT_Init()` at the beginning of the application is recommended.

Q: Can this also be used on targets that do not have the SWO pin?

A: Yes, the debug interface is used. This can be JTAG or SWD (2pins only!) on most Cortex-M devices, or even the FINE interface on some Renesas devices, just like the Infineon SPD interface (single pin!).

Q: Can this also be used on Cortex-M0 and M0+?

A: Yes.

Q: Some terminal output (`printf`) Solutions "crash" program execution when executed outside of the debug environment, because they use a Software breakpoint that triggers a hardfault without debugger or halt because SWO is not initialized. That makes it impossible to run a Debug-build in stand-alone mode. What about SEGGER-RTT?

A: SEGGER-RTT uses non-blocking mode per default, which means it does not halt program execution if no debugger is present and J-Link is not even connected. The application program will continue to work.

Q: I do not see any output, although the use of RTT in my application is correct. What can I do?

A: In some cases J-Link cannot locate the RTT buffer in the known RAM region. In this case the possible region or the exact address can be set manually via a J-Link exec command:

- Set ranges to be searched for RTT buffer: `SetRTTSearchRanges <RangeStart [Hex]> <RangeSize >[, <Range1Start [Hex]> <Range1Size>, ...]` (e.g. `"SetRTTSearchRanges 0x10000000 0x1000, 0x20000000 0x1000"`)
- Set address of the RTT buffer: `SetRTTAddr <RTTBufferAddress [Hex]>` (e.g. `"SetRTTAddr 0x20000000"`)
- Set address of the RTT buffer via J-Link Control Panel -> RTTerminal

Note

J-Link exec commands can be executed in most applications, for example in J-Link Commander via `"exec <Command>"`, in J-Link GDB Server via `"monitor exec <Command>"` or in IAR EW via `"__jlinkExecCommand("<Command>");"` from a macro file.

Chapter 17

Trace

This chapter provides information about tracing in general as well as information about how to use SEGGER J-Trace.

17.1 Introduction

With increasing complexity of embedded systems, demands to debug probes and utilities (IDE, ...) increase too. With tracing, it is possible to get an even better idea about what is happening / has happened on the target system, in case of tracking down a specific error. A special trace component in the target CPU (e.g. ETM on ARM targets) registers instruction fetches done by the CPU as well as some additional actions like execution/skipping of conditional instructions, target addresses of branch/jump instructions etc. and provides these events to the trace probe. Instruction trace allows reproducing what instructions have been executed by the CPU in which order, which conditional instructions have been executed/skipped etc., allowing to reconstruct a full execution flow of the CPU.

Note

To use any of the trace features mentioned in this chapter, the CPU needs to implement this specific trace hardware unit. For more information about which targets support tracing, please refer to *Target devices with trace support*.

17.1.1 What is backtrace?

Makes use of the information got from instruction trace and reconstructs the instruction flow from a specific point (e.g. when a breakpoint is hit) backwards as far as possible with the amount of sampled trace data.

Example scenario: A breakpoint is set on a specific error case in the source that the application occasionally hits. When the breakpoint is hit, the debugger can recreate the instruction flow, based on the trace data provided by J-Trace, of the last xx instructions that have been executed before the breakpoint was hit. This for example allows tracking down very complex problems like interrupts related ones, that are hard to find with traditional debugging methods (stepping, printf debugging, ...) as they change the real-time behavior of the application and therefore might make the problem to disappear.

17.1.2 What is streaming trace?

There are two common approaches how a trace probe collects trace data:

1. Traditional trace:

Collects trace data while the CPU is running and stores them in a buffer on the trace probe. If the buffer is full, writes continues at the start of the buffer, overwriting the oldest trace data in it. The debugger on the PC side can request trace data from the probe only when the target CPU is halted. This allows doing backtrace as described in *What is backtrace?* on page 362.

2. Streaming trace:

Trace data is collected while the CPU is running but streamed to the PC in real-time, while the target CPU continues to execute code. This increases the trace buffer (and therefore the amount of trace data that can be stored) to an theoretically unlimited size (on modern systems multiple terabytes). Streaming trace allows to implement more complex trace features like code coverage and code profiling as these require a complete instruction flow, not only the last xx executed instructions, to provide real valuable data.

17.1.3 What is code coverage?

Code coverage metrics are a way to describe the "quality" of code, as "code that is not tested does not work". A code coverage analyzer measures the execution of code and shows how much of a source line, block, function or file has been executed. With this information it is possible to detect code which has not been covered by tests or may even be unreachable.

This enables a fast and efficient way to improve the code or to create a suitable test suite for uncovered blocks.

Note

This feature also requires a J-Trace that supports streaming trace.

17.1.4 What is code profiling?

Code profiling is a form of measuring the execution time and the execution count of functions, blocks or instructions. It can be used as a metric for the complexity of a system and can highlight where computing time is spent. This provides a great insight into the running system and is essential when identifying code that is executed frequently, potentially placing a high load onto a system. The code profiling information can help to easier optimize a system, as it accurately shows which blocks take the most time and are worth optimizing.

Note

This feature also requires a J-Trace that supports streaming trace.

17.2 Tracing via trace pins

This is the most common tracing method, as it also allows to use streaming trace. The target outputs trace data + a trace clock on specific pins. These pins are sampled by J-Trace and trace data is collected. As trace data is output with a relatively high frequency (easily ≥ 100 MHz on modern embedded systems) a high end hardware is necessary on the trace probe (J-Trace) to be able to sample and digest the trace data sent by the target CPU. Our J-Trace models support up to 4-bit trace which can be manually set by the user by overwriting the global variable `JLINK_TRACE_Portwidth` which is set to 4 by default. Please refer to *Global DLL variables* .

17.2.1 Cortex-M specifics

The trace clock output by the CPU is usually 1/2 of the speed of the CPU clock, but trace data is output double data rate, meaning on each edge of the trace clock. There are usually 4 trace data pins on which data is output, resulting in 1 byte trace data being output per trace clock ($2 * 4$ bits).

17.2.2 Trace signal timing

There are certain signal timings that must be met, such as rise/fall timings for clock and data, as well as setup and hold timings for the trace data. These timings are specified by the vendor that designs the trace hardware unit (e.g. ARM that provides the ETM as a trace component for their cores). For more information about what timings need to be met for a specific J-Trace model, please refer to *J-Link / J-Trace models* .

17.2.3 Adjusting trace signal timing on J-Trace

Some target CPUs do not meet the trace timing requirements when it comes to the trace data setup times (some output the trace data at the same time they output a trace clock edge, resulting on effectively no setup time). Another case where timing requirements may not be met is for example when having one trace data line on a hardware that is longer than the other ones (necessary due to routing requirements on the PCB). For such cases, higher end J-Trace models, like J-Trace PRO, allow to adjust the timing of the trace signals, inside the J-Trace firmware. For example, in case the target CPU does not provide a (sufficient) trace data setup time, the data sample timing can be adjusted inside J-Trace. This causes the data edges to be recognized by J-Trace delayed, virtually creating a setup time for the trace data.

The trace signals can be adjusted via the [TraceSampleAdjust](#) command string. For more information about the syntax of this command string, please refer to *J-Link Command Strings* . For more information about how to use J-Link Command Strings in different environments, please refer to *Using J-Link Command Strings* . The following graphic illustrates how a adjustment of the trace data signal affects the sampling of the trace data inside the J-Trace firmware.

- $TCLK$ = trace clock output by target
- TDx = Trace data 0-3 output by target
- $TDx + \Delta t_d$ = Trace data seen by J-Trace firmware

As can be seen in the following drawings, by moving the sampling point of the TDx signal, a setup time for the trace data is generated (Δt_d). This can be used to enable tracing on targets that do not provide a setup time for the trace data.

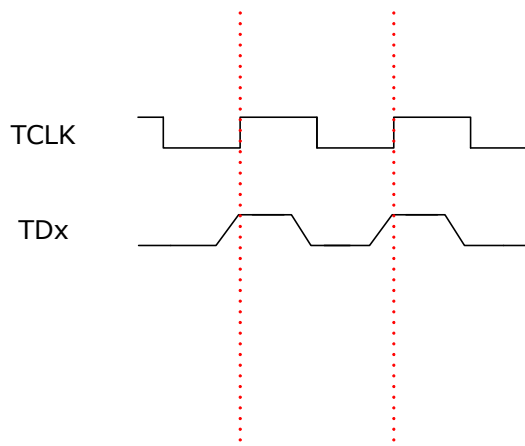

a)

Drawing a) shows the correct behavior of a target and b) shows a target that does not apply setup times. Therefore in b) the undelayed signal TDx would be sampled as a logical 0 at the rising edge of TCLK which would give the J-Trace wrong tracing information. In the case where the sample point of TDx is moved to the left (negative) by Δt_d at each rising TCLK edge a logical 1 is sampled which in this case means that the J-Trace now receives the correct trace information.

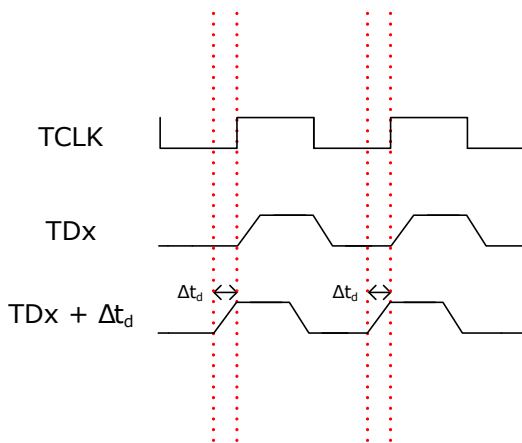

b)

17.2.4 J-Trace models with support for streaming trace

For an overview which J-Trace models support streaming trace, please refer to [SEGGER Wiki: J-Link / J-Trace / Flasher Software and Hardware features overview](#) .

17.3 Tracing with on-chip trace buffer

Some target CPUs provide trace functionality also provide an on-chip trace buffer that is used to store the trace data output by the trace hardware unit on the device. This allows to also do trace on such targets with a regular J-Link, as the on-chip trace buffer can be read out via the regular debug interface J-Link uses to communicate with the target CPU. Downside of this implementation is that it needs RAM on the target CPU that can be used as a trace buffer. This trace buffer is very limited (usually between 1 and 4 KB) and reduces the RAM that can be used by the target application, while tracing is done.

Note

Streaming trace is not possible with this trace implementation

17.3.1 CPUs that provide tracing via pins and on-chip buffer

Some CPUs provide a choice to either use the on-chip trace buffer for tracing (e.g. when the trace pins are needed as GPIOs etc. or are not available on all packages of the device).

- **For J-Link:** The on-chip trace buffer is automatically used, as this is the only method J-Link supports.
- **For J-Trace:** By default, tracing via trace pins is used. If, for some reason, the on-chip trace buffer shall be used instead, the J-Link software needs to be made aware of this. The trace source can be selected via the [SelectTraceSource](#) command string. For more information about the syntax of this command string, please refer to *J-Link Command Strings* . For more information about how to use J-Link Command Strings in different environments, please refer to *Using J-Link Command Strings* .

17.4 Target devices with trace support

For an overview for which target devices trace is supported (either via pins or via on-chip trace buffer), please refer to [List of supported target devices](#) .

17.5 Streaming trace

With introducing streaming trace, some additional concepts needed to be introduced in order to make real time analysis of the trace data possible. In the following, some considerations and specifics, that need to be kept in mind when using streaming trace, are explained.

17.5.1 Download and execution address differ

Analysis of trace data requires that J-Trace needs know which instruction is present at what address on the target device. As reading from the target memory every time is not feasible during live analysis (would lead to a too big performance drop), a copy of the application contents is cached in the J-Link software at the time the application download is performed. This implies that streaming trace is only possible with prior download of the application in the same debug session. This also implies that the execution address needs to be the same as the download address. In case both addresses differ from each other, the J-Link software needs to be told that the unknown addresses hold the same data as the cached ones. This is done via the [ReadIntoTraceCache](#) command string. For more information about the syntax of this command string, please refer to *J-Link Command Strings* . For more information about how to use J-Link Command Strings in different environments, please refer to *Using J-Link Command Strings* .

17.5.2 Do streaming trace without prior download

Same specifics as for "load and execution address differ" applies.
Please refer to *Download and execution address differ* .

Chapter 18

Target interfaces and adapters

This chapter gives an overview about J-Link / J-Trace specific hardware details, such as the pinouts and available adapters.

18.1 20-pin J-Link connector

18.1.1 Pinout for JTAG

VTref	1 ●	● 2	NC
nTRST	3 ●	● 4	GND
TDI	5 ●	● 6	GND
TMS	7 ●	● 8	GND
TCK	9 ●	● 10	GND
RTCK	11 ●	● 12	GND
TDO	13 ●	● 14	*
RESET	15 ●	● 16	*
DBGREQ	17 ●	● 18	*
5V-Supply	19 ●	● 20	*

J-Link and J-Trace have a JTAG connector compatible to ARM’s Multi-ICE. The JTAG connector is a 20 way Insulation Displacement Connector (IDC) keyed box header (2.54mm male) that mates with IDC sockets mounted on a ribbon cable.

**On some models like the J-Link ULTRA, these pins are reserved for firmware extension purposes. They can be left open or connected to GND in normal debug environment. Please do not assume them to be connected to GND inside J-Link.*

The following table lists the J-Link / J-Trace JTAG pinout.

PIN	SIGNAL	TYPE	Description
1	VTref	Input	This is the target reference voltage. It is used to check if the target has power, to create the logic-level reference for the input comparators and to control the output logic levels to the target. It is normally fed from VDD of the target board and must not have a series resistor.
2	Not connected	NC	This pin is not connected in J-Link.
3	nTRST	Output	JTAG Reset. Output from J-Link to the Reset signal of the target JTAG port. Typically connected to nTRST of the target CPU. This pin is normally pulled HIGH on the target to avoid unintentional resets when there is no connection.
5	TDI	Output	JTAG data input of target CPU. It is recommended that this pin is pulled to a defined state on the target board. Typically connected to TDI of the target CPU.
7	TMS	Output	JTAG mode set input of target CPU. This pin should be pulled up on the target. Typically connected to TMS of the target CPU.
9	TCK	Output	JTAG clock signal to target CPU. It is recommended that this pin is pulled to a defined state of the target board. Typically connected to TCK of the target CPU.
11	RTCK	Input	Return test clock signal from the target. Some targets must synchronize the JTAG inputs to internal clocks. To assist in meeting this requirement, you can use a returned, and re-timed, TCK to dynamically control the TCK rate. J-Link supports adaptive clocking, which waits for TCK changes to be echoed correctly before making further changes. Connect to RTCK if available, otherwise to GND.
13	TDO	Input	JTAG data output from target CPU. Typically connected to TDO of the target CPU.
15	nRESET	I/O	Target CPU reset signal. Typically connected to the RESET pin of the target CPU, which is typically called “nRST”, “nRESET” or “RESET”. This signal is an active low signal.
17	DBGREQ	NC	This pin is not connected in J-Link. It is reserved for compatibility with other equipment to be used as a debug request signal to the target system. Typically connected to DBGREQ if available, otherwise left open.

PIN	SIGNAL	TYPE	Description
19	5V-Supply	Output	This pin can be used to supply power to the target hardware. Older J-Links may not be able to supply power on this pin. For more information about how to enable/disable the power supply, please refer to <i>Target power supply</i> .

Pins 4, 6, 8, 10, 12 are GND pins connected to GND in J-Link. They should also be connected to GND in the target system.

18.1.1.1 Target board design

We strongly advise following the recommendations given by the chip manufacturer. These recommendations are normally in line with the recommendations given in the table *Pinout for JTAG* on page 370. In case of doubt you should follow the recommendations given by the semiconductor manufacturer. You may take any female header following the specifications of DIN 41651. For example:

- Harting part-no. 09185206803
- Molex part-no. 90635-1202
- Tyco Electronics part-no. 2-215882-0

Typical target connection for JTAG

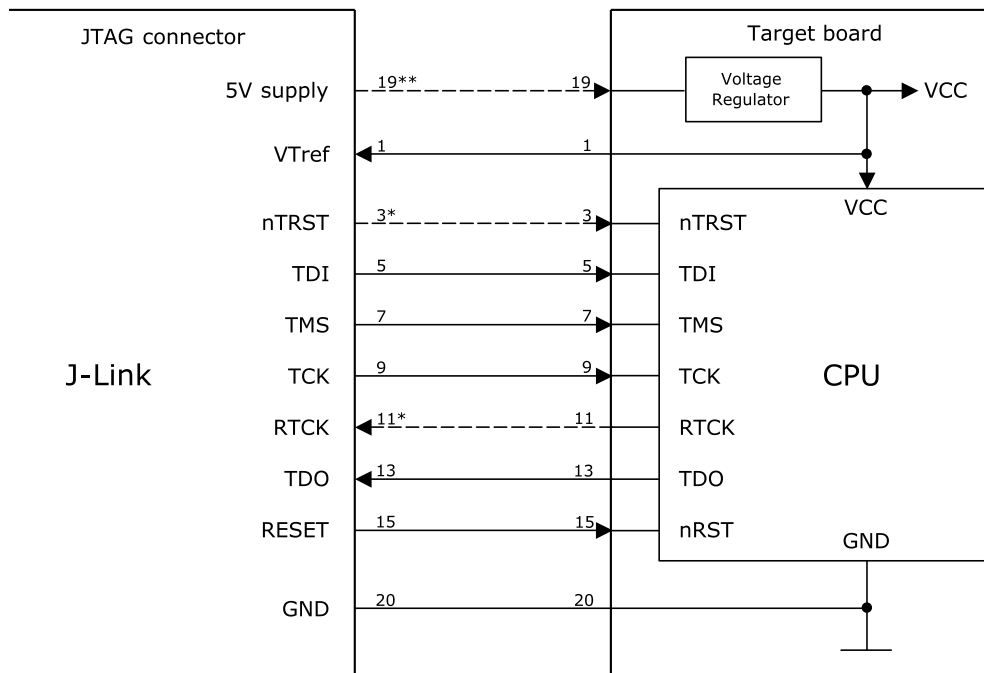

* NTRST and RTCK may not be available on some CPUs.
 ** Optional to supply the target board from J-Link.

18.1.1.2 Pull-up/pull-down resistors

Unless otherwise specified by developer’s manual, pull-ups/pull-downs are recommended to 100 kOhms.

18.1.1.3 Target power supply

Pin 19 of the connector can be used to supply power to the target hardware. Supply voltage is 5V, max. current is 300mA. The output current is monitored and protected against overload and short-circuit. Power can be controlled via the J-Link commander. The following commands are available to control power:

Command	Explanation
power on	Switch target power on

Command	Explanation
power off	Switch target power off
power on perm	Set target power supply default to "on"
power off perm	Set target power supply default to "off"

18.1.2 Pinout for SWD

VTref	1 ● ● 2	NC
Not used	3 ● ● 4	GND
Not used	5 ● ● 6	GND
SWDIO	7 ● ● 8	GND
SWCLK	9 ● ● 10	GND
Not used	11 ● ● 12	GND
SWO	13 ● ● 14	*
RESET	15 ● ● 16	*
Not used	17 ● ● 18	*
5V-Supply	19 ● ● 20	*

The J-Link and J-Trace JTAG connector is also compatible to ARM's Serial Wire Debug (SWD).

**On some models like the J-Link ULTRA, these pins are reserved for firmware extension purposes. They can be left open or connected to GND in normal debug environment. Please do not assume them to be connected to GND inside J-Link.*

The following table lists the J-Link / J-Trace SWD pinout.

PIN	SIGNAL	TYPE	Description
1	VTref	Input	This is the target reference voltage. It is used to check if the target has power, to create the logic-level reference for the input comparators and to control the output logic levels to the target. It is normally fed from Vdd of the target board and must not have a series resistor.
2	Not connected	NC	This pin is not connected in J-Link.
3	Not used	NC	This pin is not used by J-Link. If the device may also be accessed via JTAG, this pin may be connected to nTRST, otherwise leave open.
5	Not used	NC	This pin is not used by J-Link. If the device may also be accessed via JTAG, this pin may be connected to TDI, otherwise leave open.
7	SWDIO	I/O	Single bi-directional data pin. A pull-up resistor is required. ARM recommends 100 kOhms.
9	SWCLK	Output	Clock signal to target CPU. It is recommended that this pin is pulled to a defined state on the target board. Typically connected to TCK of the target CPU.
11	Not used	NC	This pin is not used by J-Link. If the device may also be accessed via JTAG, this pin may be connected to RTCK, otherwise leave open.
13	SWO	Input	Serial Wire Output trace port. (Optional, not required for SWD communication.)
15	nRESET	I/O	Target CPU reset signal. Typically connected to the RESET pin of the target CPU, which is typically called "nRST", "nRESET" or "RESET". This signal is an active low signal.
17	Not Used	NC	This pin is not connected in J-Link.
19	5V-Supply	Output	This pin can be used to supply power to the target hardware. Older J-Links may not be able to supply power on this pin. For more information about how to enable/disable the power supply, please refer to <i>Target power supply</i> .

Pins 4, 6, 8, 10, 12 are GND pins connected to GND in J-Link. They should also be connected to GND in the target system.

18.1.2.1 Target board design

We strongly advise following the recommendations given by the chip manufacturer. These recommendations are normally in line with the recommendations given in the table *Pinout for SWD* on page 372. In case of doubt you should follow the recommendations given by the semiconductor manufacturer.

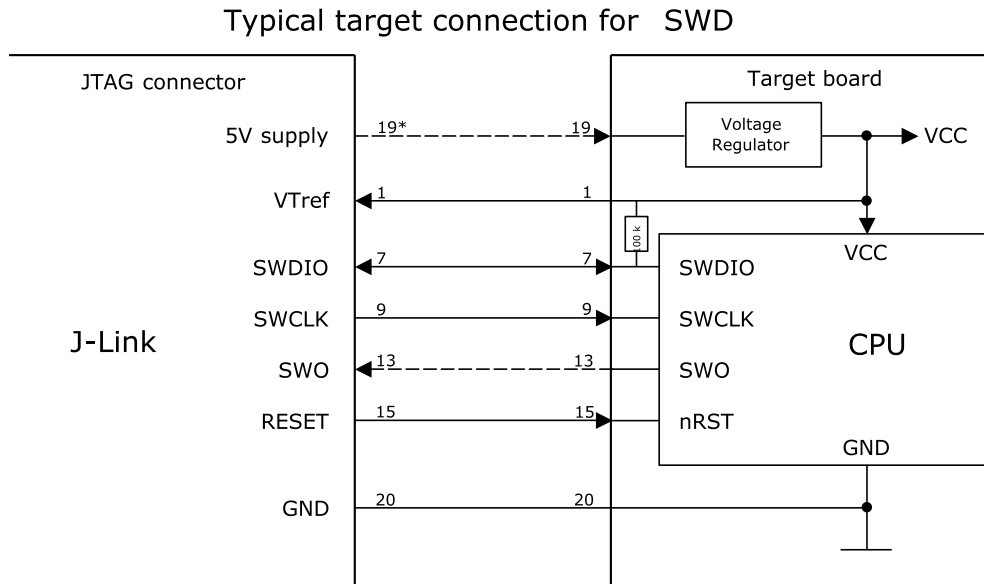

18.1.2.2 Pull-up/pull-down resistors

A pull-up resistor is required on SWDIO on the target board. ARM recommends 100 kOhms. In case of doubt you should follow the recommendations given by the semiconductor manufacturer.

18.1.2.3 Target power supply

Pin 19 of the connector can be used to supply power to the target hardware. Supply voltage is 5V, max. current is 300mA. The output current is monitored and protected against overload and short-circuit. Power can be controlled via the J-Link commander. The following commands are available to control power:

Command	Explanation
<code>power on</code>	Switch target power on
<code>power off</code>	Switch target power off
<code>power on perm</code>	Set target power supply default to "on"
<code>power off perm</code>	Set target power supply default to "off"

18.1.3 Pinout for SWD + Virtual COM Port (VCOM)

VTref	1 ●	● 2	NC
Not used	3 ●	● 4	GND
J-Link Tx	5 ●	● 6	GND
SWDIO	7 ●	● 8	GND
SWCLK	9 ●	● 10	GND
Not used	11 ●	● 12	GND
SWO	13 ●	● 14	*
RESET	15 ●	● 16	*
J-Link Rx	17 ●	● 18	*
5V-Supply	19 ●	● 20	*

The J-Link and J-Trace JTAG connector is also compatible to ARM’s Serial Wire Debug (SWD).

**On some models like the J-Link ULTRA, these pins are reserved for firmware extension purposes. They can be left open or connected to GND in normal debug environment. Please do not assume them to be connected to GND inside J-Link.*

The following table lists the J-Link / J-Trace SWD pinout.

PIN	SIGNAL	TYPE	Description
1	VTref	Input	This is the target reference voltage. It is used to check if the target has power, to create the logic-level reference for the input comparators and to control the output logic levels to the target. It is normally fed from Vdd of the target board and must not have a series resistor.
2	Not connected	NC	This pin is not connected in J-Link.
3	Not used	NC	This pin is not used by J-Link. If the device may also be accessed via JTAG, this pin may be connected to nTRST, otherwise leave open.
5	J-Link Tx	Output	This pin is used as VCOM Tx (out on J-Link side) in case VCOM functionality of J-Link is enabled. For further information about VCOM, please refer to <i>Virtual COM Port (VCOM)</i> .
7	SWDIO	I/O	Single bi-directional data pin. A pull-up resistor is required. ARM recommends 100 kOhms.
9	SWCLK	Output	Clock signal to target CPU. It is recommended that this pin is pulled to a defined state on the target board. Typically connected to TCK of the target CPU.
11	Not used	NC	This pin is not used by J-Link. If the device may also be accessed via JTAG, this pin may be connected to RTCK, otherwise leave open.
13	SWO	Input	Serial Wire Output trace port. (Optional, not required for SWD communication.)
15	nRESET	I/O	Target CPU reset signal. Typically connected to the RESET pin of the target CPU, which is typically called “nRST”, “nRESET” or “RESET”. This signal is an active low signal.
17	J-Link Rx	Input	This pin is used as VCOM Rx (in on J-Link side) in case VCOM functionality of J-Link is enabled. For further information, please refer to <i>Virtual COM Port (VCOM)</i> .
19	5V-Supply	Output	This pin can be used to supply power to the target hardware. Older J-Links may not be able to supply power on this pin. For more information about how to enable/disable the power supply, please refer to <i>Virtual COM Port (VCOM)</i> .

18.1.4 Pinout for SPI

VTref	1 ●	● 2	NC
NC	3 ●	● 4	GND
DI	5 ●	● 6	GND
nCS	7 ●	● 8	GND
CLK	9 ●	● 10	GND
NC	11 ●	● 12	GND
DO	13 ●	● 14	*
nRESET	15 ●	● 16	*
NC	17 ●	● 18	*
5V-Supply	19 ●	● 20	*

**On some models like the J-Link ULTRA, these pins are reserved for firmware extension purposes. They can be left open or connected to GND in normal debug environment. Please do not assume them to be connected to GND inside J-Link.*

The following table lists the pinout for the SPI interface on J-Link.

PIN	SIGNAL	TYPE	Description
1	VTref	Input	This is the target reference voltage. It is used to check if the target has power, to create the logic-level reference for the input comparators and to control the output logic levels to the target. It is normally fed from Vdd of the target board and must not have a series resistor.
2	Not connected	NC	Leave open on target side
3	Not connected	NC	Leave open on target side
5	DI	Output	Data-input of target SPI. Output of J-Link, used to transmit data to the target SPI.
7	nCS	Output	Chip-select of target SPI (active LOW).
9	CLK	Output	SPI clock signal.
11	Not connected	NC	Leave open on target side
13	DO	Input	Data-out of target SPI. Input of J-Link, used to receive data from the target SPI.
15	nRESET	I/O	Target CPU reset signal. Typically connected to the RESET pin of the target CPU, which is typically called "nRST", "nRESET" or "RESET". This signal is an active low signal.
17	Not connected	NC	Leave open on target side
19	5V-Supply	Output	This pin can be used to supply power to the target hardware. Older J-Links may not be able to supply power on this pin. For more information about how to enable/disable the power supply, please refer to <i>Target power supply</i> .

18.2 19-pin JTAG/SWD and Trace connector

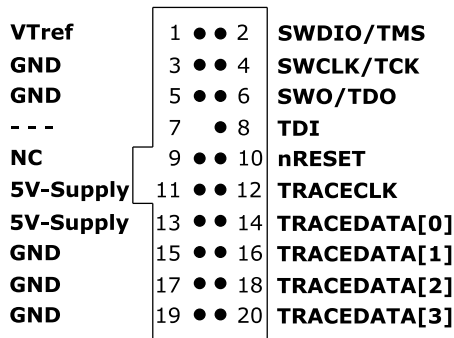

J-Trace provides a JTAG/SWD+Trace connector. This connector is a 19-pin connector (0.05" / 1.27mm). It connects to the target via an 1-1 cable.

The following table lists the J-Link / J-Trace SWD pinout.

PIN	SIGNAL	TYPE	Description
1	VTref	Input	This is the target reference voltage. It is used to check if the target has power, to create the logic-level reference for the input comparators and to control the output logic levels to the target. It is normally fed from Vdd of the target board and must not have a series resistor.
2	SWDIO / TMS	I/O / output	SWDIO: (Single) bi-directional data pin. JTAG mode set input of target CPU. This pin should be pulled up on the target. Typically connected to TMS of the target CPU.
4	SWCLK / TCK	Output	SWCLK: Clock signal to target CPU. It is recommended that this pin is pulled to a defined state of the target board. Typically connected to TCK of target CPU. JTAG clock signal to target CPU.
6	SWO / TDO	Input	JTAG data output from target CPU. Typically connected to TDO of the target CPU. When using SWD, this pin is used as Serial Wire Output trace port. (Optional, not required for SWD communication)
—	—	—	This pin (normally pin 7) is not existent on the 19-pin JTAG/SWD and Trace connector.
8	TDI	Output	JTAG data input of target CPU. It is recommended that this pin is pulled to a defined state on the target board. Typically connected to TDI of the target CPU. For CPUs which do not provide TDI (SWD-only devices), this pin is not used. J-Link will ignore the signal on this pin when using SWD.
9	NC	NC	Not connected inside J-Link. Leave open on target hardware.
10	nRESET	I/O	Target CPU reset signal. Typically connected to the RESET pin of the target CPU, which is typically called "nRST", "nRESET" or "RESET". This signal is an active low signal.
11	5V-Supply	Output	This pin can be used to supply power to the target hardware. For more information about how to enable/disable the power supply, please refer to <i>Target power supply</i> .
12	TRACECLK	Input	Input trace clock. Trace clock = 1/2 CPU clock.
13	5V-Supply	Output	This pin can be used to supply power to the target hardware. For more information about how to enable/disable the power supply, please refer to <i>Target power supply</i> .
14	TRACE-DATA[0]	Input	Input Trace data pin 0.
16	TRACE-	Input	Input Trace data pin 1.

PIN	SIGNAL	TYPE	Description
	DATA[1]		
18	TRACE-DATA[2]	Input	Input Trace data pin 2.
20	TRACE-DATA[3]	Input	Input Trace data pin 3.

18.2.1 Connecting the target board

J-Trace connects to the target board via a 19-pin trace cable. Alternatively J-Trace can be connected with a 20-pin JTAG cable.

Note

Never connect trace cable and JTAG cable at the same time because this may lead to unstable debug and trace connections.

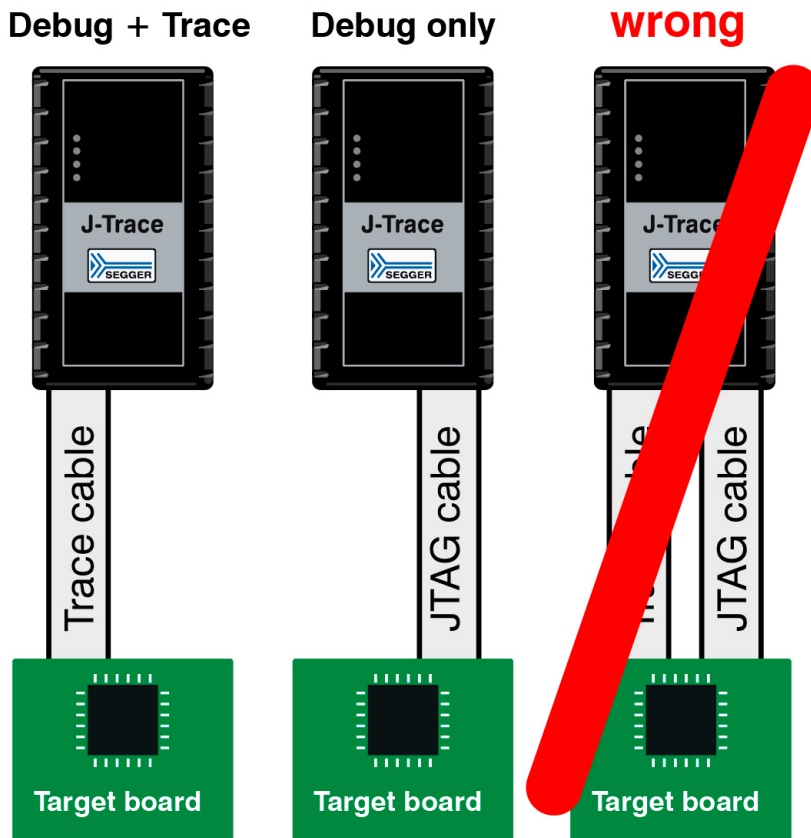

18.2.2 Target power supply

Pins 11 and 13 of the connector can be used to supply power to the target hardware. Supply voltage is 5V, max. current is 300mA. The output current is monitored and protected against overload and short-circuit. Power can be controlled via the J-Link commander. The following commands are available to control power:

Command	Explanation
power on	Switch target power on
power off	Switch target power off

Command	Explanation
power on	perm Set target power supply default to "on"
power off	perm Set target power supply default to "off"

18.3 9-pin JTAG/SWD connector

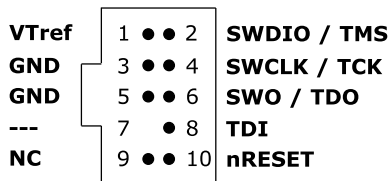

Some target boards only provide a 9-pin JTAG/SWD connector for Cortex-M. or these devices SEGGER provides a 20-pin -> 9-pin Cortex-M adapter.

PIN	SIGNAL	TYPE	Description
1	VTref	Input	This is the target reference voltage. It is used to check if the target has power, to create the logic-level reference for the input comparators and to control the output logic levels to the target. It is normally fed from Vdd of the target board and must not have a series resistor.
2	SWDIO / TMS	I/O / output	SWDIO: (Single) bi-directional data pin. JTAG mode set input of target CPU. This pin should be pulled up on the target. Typically connected to TMS of the target CPU.
4	SWCLK / TCK	Output	SWCLK: Clock signal to target CPU. It is recommended that this pin is pulled to a defined state of the target board. Typically connected to TCK of target CPU. JTAG clock signal to target CPU.
6	SWO / TDO	Input	JTAG data output from target CPU. Typically connected to TDO of the target CPU. When using SWD, this pin is used as Serial Wire Output trace port. (Optional, not required for SWD communication)
—	—	—	This pin (normally pin 7) is not existent on the 19-pin JTAG/SWD and Trace connector.
8	TDI	Output	JTAG data input of target CPU.- It is recommended that this pin is pulled to a defined state on the target board. Typically connected to TDI of the target CPU. For CPUs which do not provide TDI (SWD-only devices), this pin is not used. J-Link will ignore the signal on this pin when using SWD.
9	NC (TRST)	NC	By default, TRST is not connected, but the Cortex-M Adapter comes with a solder bridge (NR1) which allows TRST to be connected to pin 9 of the Cortex-M adapter.

18.4 Reference voltage (VTref)

VTref is the target reference voltage. It is used by the J-Link to check if the target has power, to create the logic-level reference for the input comparators and to control the output logic levels to the target. It is normally fed from Vdd of the target board and must not have a series resistor.

In cases where the VTref signal should not be wired to save one more pin / place on the target hardware interface connector (e.g. in production environments), SEGGER offers a special adapter called J-Link Supply Adapter which can be used for such purposes. Further information regarding this, can be found on the SEGGER website ([J-Link supply adapter](#))

To guarantee proper debug functionality, please make sure to connect at least on of the GND pins to GND (Pin 4, 6, 8, 10, 12, 14*, 16*, 18*, 20*).

Note

*On some models like the J-Link ULTRA, these pins are reserved for firmware extension purposes. They can be left open or connected to GND in normal debug environment. Please do not assume them to be connected to GND inside J-Link.

18.5 Adapters

There are various adapters available for J-Link as for example the JTAG isolator, the J-Link RX adapter or the J-Link Cortex-M adapter.

For more information about the different adapters, please refer to [J-Link adapters](#)

Chapter 19

Background information

This chapter provides background information about JTAG and ARM. The ARM7 and ARM9 architecture is based on Reduced Instruction Set Computer (RISC) principles. The instruction set and the related decode mechanism are greatly simplified compared with microprogrammed Complex Instruction Set Computer (CISC).

19.1 JTAG

JTAG is the acronym for Joint Test Action Group. In the scope of this document, “the JTAG standard” means compliance with IEEE Standard 1149.1-2001.

19.1.1 Test access port (TAP)

JTAG defines a TAP (Test access port). The TAP is a general-purpose port that can provide access to many test support functions built into a component. It is composed as a minimum of the three input connections (TDI, TCK, TMS) and one output connection (TDO). An optional fourth input connection (nTRST) provides for asynchronous initialization of the test logic.

PIN	Type	Explanation
TCK	Input	The test clock input (TCK) provides the clock for the test logic.
TDI	Input	Serial test instructions and data are received by the test logic at test data input (TDI).
TMS	Input	The signal received at test mode select (TMS) is decoded by the TAP controller to control test operations.
TDO	Output	Test data output (TDO) is the serial output for test instructions and data from the test logic.
nTRST	Input (optional)	The optional test reset (nTRST) input provides for asynchronous initialization of the TAP controller.

19.1.2 Data registers

JTAG requires at least two data registers to be present: the bypass and the boundary-scan register. Other registers are allowed but are not obligatory.

Bypass data register

A single-bit register that passes information from TDI to TDO.

Boundary-scan data register

A test data register which allows the testing of board interconnections, access to input and output of components when testing their system logic and so on.

19.1.3 Instruction register

The instruction register holds the current instruction and its content is used by the TAP controller to decide which test to perform or which data register to access. It consists of at least two shift-register cells.

19.1.4 The TAP controller

The TAP controller is a synchronous finite state machine that responds to changes at the TMS and TCK signals of the TAP and controls the sequence of operations of the circuitry.

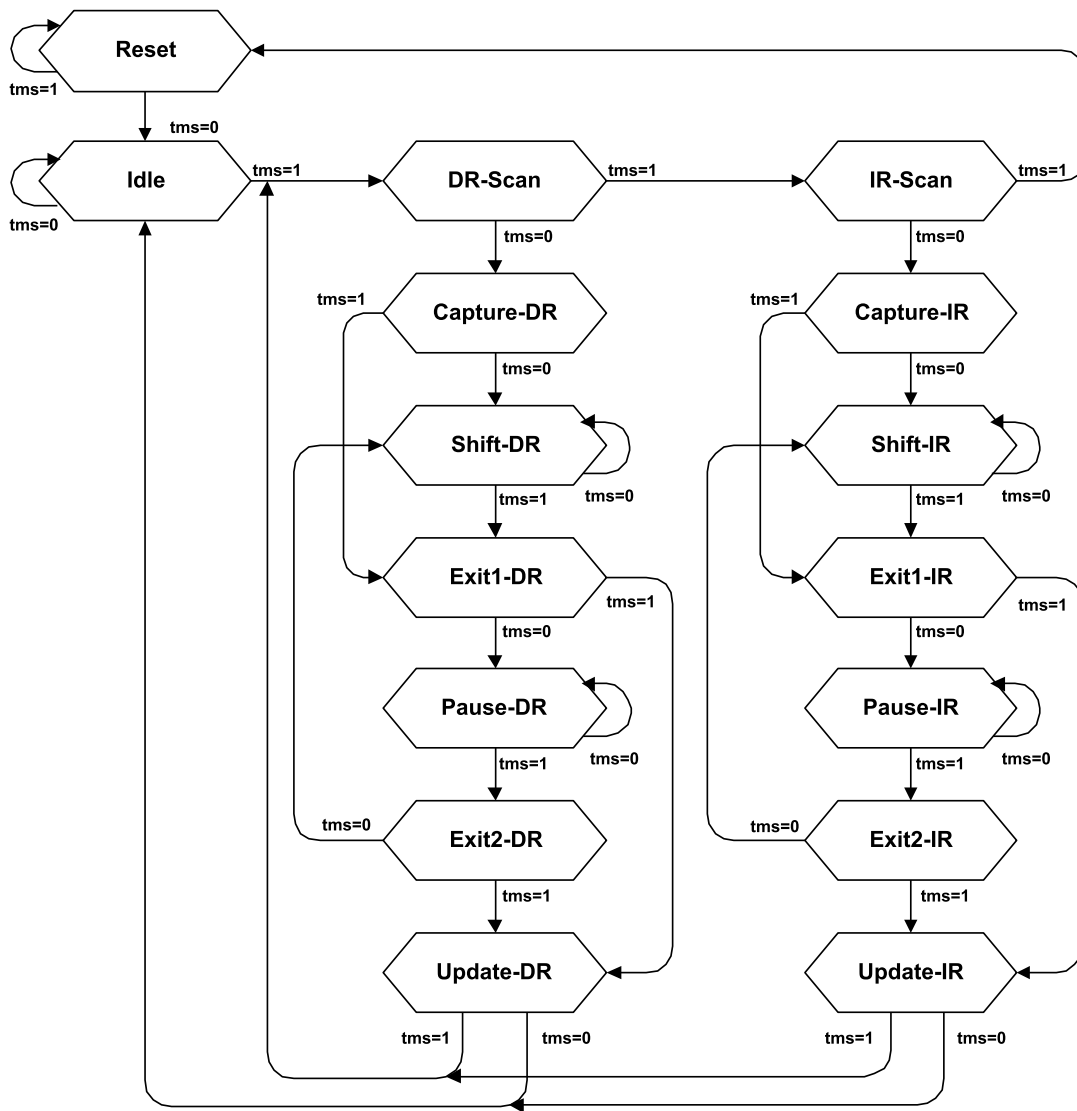

19.1.4.1 State descriptions

Reset

The test logic is disabled so that normal operation of the chip logic can continue unhindered. No matter in which state the TAP controller currently is, it can change into Reset state if TMS is high for at least 5 clock cycles. As long as TMS is high, the TAP controller remains in Reset state.

Idle

Idle is a TAP controller state between scan (DR or IR) operations. Once entered, this state remains active as long as TMS is low.

DR-Scan

Temporary controller state. If TMS remains low, a scan sequence for the selected data registers is initiated.

IR-Scan

Temporary controller state. If TMS remains low, a scan sequence for the instruction register is initiated.

Capture-DR

Data may be loaded in parallel to the selected test data registers.

Shift-DR

The test data register connected between TDI and TDO shifts data one stage towards the serial output with each clock.

Exit1-DR

Temporary controller state.

Pause-DR

The shifting of the test data register between TDI and TDO is temporarily halted.

Exit2-DR

Temporary controller state. Allows to either go back into Shift-DR state or go on to Update-DR.

Update-DR

Data contained in the currently selected data register is loaded into a latched parallel output (for registers that have such a latch). The parallel latch prevents changes at the parallel output of these registers from occurring during the shifting process.

Capture-IR

Instructions may be loaded in parallel into the instruction register.

Shift-IR

The instruction register shifts the values in the instruction register towards TDO with each clock.

Exit1-IR

Temporary controller state.

Pause-IR

Wait state that temporarily halts the instruction shifting.

Exit2-IR

Temporary controller state. Allows to either go back into Shift-IR state or go on to Update-IR.

Update-IR

The values contained in the instruction register are loaded into a latched parallel output from the shift-register path. Once latched, this new instruction becomes the current one. The parallel latch prevents changes at the parallel output of the instruction register from occurring during the shifting process.

19.2 Embedded Trace Macrocell (ETM)

Embedded Trace Macrocell (ETM) provides comprehensive debug and trace facilities for ARM processors. ETM allows to capture information on the processor's state without affecting the processor's performance. The trace information is exported immediately after it has been captured, through a special trace port.

Microcontrollers that include an ETM allow detailed program execution to be recorded and saved in real time. This information can be used to analyze program flow and execution time, perform profiling and locate software bugs that are otherwise very hard to locate. A typical situation in which code trace is extremely valuable, is to find out how and why a "program crash" occurred in case of a runaway program count.

A debugger provides the user interface to J-Trace and the stored trace data. The debugger enables all the ETM facilities and displays the trace information that has been captured. J-Trace is seamlessly integrated into the IAR Embedded Workbench® IDE. The advanced trace debugging features can be used with the IAR C-SPY debugger.

19.2.1 Trigger condition

The ETM can be configured in software to store trace information only after a specific sequence of conditions. When the trigger condition occurs the trace capture stops after a programmable period.

19.2.2 Code tracing and data tracing

Code trace

Code tracing means that the processor outputs trace data which contain information about the instructions that have been executed at last.

Data trace

Data tracing means that the processor outputs trace data about memory accesses (read / write access to which address and which data has been read / stored). In general, J-Trace supports data tracing, but it depends on the debugger if this option is available or not. Note that when using data trace, the amount of trace data to be captured rises enormously.

19.2.3 J-Trace integration example - IAR Embedded Workbench for ARM

In the following a sample integration of J-Trace and the trace functionality on the debugger side is shown. The sample is based on IAR's Embedded Workbench for ARM integration of J-Trace.

19.2.3.2 Code coverage - Source code tracing

The screenshot shows the IAR Embedded Workbench IDE interface. The main window displays the source code for a microcontroller, with several lines highlighted in red and yellow. The disassembly window on the right shows the corresponding assembly instructions. The bottom window shows a table of trace data with columns for Index, Frame, Address, Opcode, Trace, and Comment.

Index	Frame	Address	Opcode	Trace	Comment
002368	002686	0x0800B5A4	B510	RCC_GetFlagStatus(u8)	
002403	002721	0x0800BEBE	2800	Clk_Init() + 66	
002407	002725	0x0800B5A4	B510	RCC_GetFlagStatus(u8)	
002442	002760	0x0800BEBE	2800	Clk_Init() + 66	
002446	002764	0x0800B5A4	B510	RCC_GetFlagStatus(u8)	
002481	002799	0x0800BEBE	2800	Clk_Init() + 66	
002485	002803	0x0800B5A4	B510	RCC_GetFlagStatus(u8)	
002520	002838	0x0800BEBE	2800	Clk_Init() + 66	
002524	002842	0x0800B5A4	B510	RCC_GetFlagStatus(u8)	
002559	002877	0x0800BEBE	2800	Clk_Init() + 66	
002563	002881	0x0800B5A4	B510	RCC_GetFlagStatus(u8)	
002598	002916	0x0800BEBE	2800	Clk_Init() + 66	
002602	002920	0x0800B5A4	B510	RCC_GetFlagStatus(u8)	
002637	002955	0x0800BEBE	2800	Clk_Init() + 66	
002641	002959	0x0800B5A4	B510	RCC_GetFlagStatus(u8)	
002676	002994	0x0800BEBE	2800	Clk_Init() + 66	
002680	002998	0x0800B5A4	B510	RCC_GetFlagStatus(u8)	
002715	003033	0x0800BEBE	2800	Clk_Init() + 66	
002719	003037	0x0800B5A4	B510	RCC_GetFlagStatus(u8)	
002754	003072	0x0800BEBE	2800	Clk_Init() + 66	
002758	003076	0x0800B5A4	B510	RCC_GetFlagStatus(u8)	
002793	003111	0x0800BEBE	2800	Clk_Init() + 66	
002797	003115	0x0800B5A4	B510	RCC_GetFlagStatus(u8)	
002832	003150	0x0800BEBE	2800	Clk_Init() + 66	
002836	003154	0x0800B5A4	B510	RCC_GetFlagStatus(u8)	
002871	003189	0x0800BEBE	2800	Clk_Init() + 66	
002875	003193	0x0800B3C8	B510	RCC_USBCLKConfig(u32)	
002883	003201	0x0800BEC8	F44F	Clk_Init() + 76	
002885	003203	0x0800B3C8	B510	RCC_ADCLKConfig(u32)	
002906	003224	0x0800BED0	2000	Clk_Init() + 84	
002908	003226	0x0800B37C	B510	RCC_PCLK2Config(u32)	
002923	003241	0x0800BED6	F44F	Clk_Init() + 90	
002925	003243	0x0800B334	B510	RCC_PCLK1Config(u32)	
002942	003260	0x0800BEDE	2000	Clk_Init() + 98	
002944	003262	0x0800B2E4	B510	RCC_HCLKConfig(u32)	
002959	003277	0x0800BEE4	2002	Clk_Init() + 104	
002961	003279	0x0800D70C	B510	FLASH_SetLatency(u32)	
002985	003303	0x0800BEEA	2000	Clk_Init() + 110	
002987	003305	0x0800D746	B510	FLASH_HalFcycleAccessCmd(u32)	
003009	003327	0x0800BEF0	2010	Clk_Init() + 116	
003011	003329	0x0800D77C	B510	FLASH_PrefetchBufferCmd(u32)	
003031	003349	0x0800BEF6	2002	Clk_Init() + 122	
003033	003351	0x0800B24C	B510	RCC_SYSClkConfig(u32)	
003053	003371	0x0800BEFC	B0D1	Clk_Init() + 128	
003054	003372	0x0800BF88	2100	main() + 16	
003057	003375	0x0800B28C	B538	NVIC_SetVectorTable(u32, u32)	
003075	003393	0x0800BF2C	F44F	main() + 26	
003077	003395	0x0800B84C	B510	NVIC_PriorityGroupConfig(u32)	
003096	003414	0x0800BFCA	4876	main() + 34	

The screenshot displays the IAR Embedded Workbench IDE interface. The main window shows the source code for the `main.c` file, specifically the `stm3210x_nvic.c` module. The code includes comments and function definitions for `NVIC_Init` and `NVIC_PriorityGroupConfig`. The `NVIC_Init` function is highlighted in yellow, showing its parameters and return value. The `NVIC_PriorityGroupConfig` function is also highlighted, showing its parameters and return value. The disassembly window on the right shows the assembly code for the `NVIC_PriorityGroupConfig` function, with the `NVIC_PriorityGroupConfig` function name highlighted in yellow. The ETM trace window at the bottom shows a list of instructions with their addresses, opcodes, and traces. The trace for the `NVIC_PriorityGroupConfig` function is highlighted in yellow.

```

74 SCB->HFSR = 0xFFFFFFFF;
75 SCB->DFSR = 0xFFFFFFFF;
76
77
78
79 * Function Name : NVIC_PriorityGroupConfig
80 * Description : Configures the priority grouping: pre-emption priority
81 * and subpriority.
82 * Input : - NVIC_PriorityGroup: specifies the priority grouping bits
83 * length. This parameter can be one of the following values:
84 * - NVIC_PriorityGroup_0: 0 bits for pre-emption priority
85 * - NVIC_PriorityGroup_1: 1 bits for pre-emption priority
86 * - NVIC_PriorityGroup_2: 2 bits for pre-emption priority
87 * - NVIC_PriorityGroup_3: 3 bits for pre-emption priority
88 * - NVIC_PriorityGroup_4: 4 bits for pre-emption priority
89 * Output : None
90 * Return : None
91
92 void NVIC_PriorityGroupConfig(u32 NVIC_PriorityGroup)
93
94 /* Check the parameters */
95 assert_param(IS_NVIC_PRIORITY_GROUP(NVIC_PriorityGroup));
96
97 /* Set the PRIGROUP[10:8] bits according to NVIC_PriorityGroup value */
98 SCB->AIRCR = AIRCR_VECTKEY_MASK | NVIC_PriorityGroup;
99
100
101
102 * Function Name : NVIC_Init
103 * Description : Initializes the NVIC peripheral according to the specified
104 * parameters in the NVIC_InitStructure
105 * Input : - NVIC_InitStructure: pointer to a NVIC_InitTypeDef structure
106 * that contains the configuration information for the
107 * specified NVIC peripheral.
108 * Output : None
109 * Return : None
110
111 void NVIC_Init(NVIC_InitTypeDef* NVIC_InitStructure)
112
113 u32 tmppriority = 0x00, tmppreg = 0x00, tmpmask = 0x00;
114 u32 tmppre = 0, tmpsub = 0x0F;
115
116 /* Check the parameters */

```

The disassembly window shows the following assembly code for the `NVIC_PriorityGroupConfig` function:

```

.text_661
0800D842 4770 BX LR
DMA2_Channel1_IRQHandler:
DMA2_Channel1_IRQHandler:
.text_67:
0800D844 4770 BX LR
DMA2_Channel2_IRQHandler:
DMA2_Channel2_IRQHandler:
.text_68:
0800D846 4770 BX LR
DMA2_Channel3_IRQHandler:
DMA2_Channel3_IRQHandler:
.text_69:
0800D848 4770 BX LR
DMA2_Channel4_5_IRQHandler:
DMA2_Channel4_5_IRQHandler:
0800D84A 4770 BX LR
void NVIC_PriorityGroupConfig(u32 NVIC_PriorityGroup)
NVIC_PriorityGroupConfig:
NVIC_PriorityGroupConfig:
.text_75
0800D84C B510 PUSH {R4,LR}
0800D84E 0004 MOV5 R4,RO
assert_param(IS_NVIC_PRIORITY_GROUP(NVIC_PriorityGroup)):
0800D850 D008 BEQ R4,#0x700
0800D852 F5B4F00 CMP R4,#0x500
0800D854 D008 BEQ R4,#0x600
0800D856 F5B4F00 CMP R4,#0x500
0800D858 D008 BEQ ??NVIC_PriorityGroupConfig_0
0800D85A F5B4F00 CMP R4,#0x400
0800D85C D008 BEQ ??NVIC_PriorityGroupConfig_0
0800D85E F5B4F00 CMP R4,#0x300
0800D860 D008 BEQ ??NVIC_PriorityGroupConfig_0
0800D862 F5B4F00 CMP R4,#0x300
0800D864 D008 BEQ ??NVIC_PriorityGroupConfig_1
0800D866 0100 BNE ??NVIC_PriorityGroupConfig_0:
??NVIC_PriorityGroupConfig_0:
??NVIC_PriorityGroupConfig_1:
0800D870 2164 MOV5 R1,#0x64
0800D872 F80F0C LDR.W R0,[R0,#0x5]
0800D874 F7FECAB BL assert_failed
0800D876 F7FECAB BL assert_failed
0800D878 0000 B
??NVIC_PriorityGroupConfig_2:
??NVIC_PriorityGroupConfig_2:
0800D87A F80F0C LDR.W R0,[R0,#0x5]
0800D87C 0000 B

```

The ETM trace window shows the following trace data:

Index	Frame	Address	Opcode	Trace	Comment
002368	002686	0x0800B5A4	B510	RCC_GetFlagStatus(u8)	
002403	002721	0x0800BEBE	2800	Clk_Init() + 66	
002407	002725	0x0800B5A4	B510	RCC_GetFlagStatus(u8)	
002442	002760	0x0800BEBE	2800	Clk_Init() + 66	
002446	002764	0x0800B5A4	B510	RCC_GetFlagStatus(u8)	
002481	002799	0x0800BEBE	2800	Clk_Init() + 66	
002485	002803	0x0800B5A4	B510	RCC_GetFlagStatus(u8)	
002529	002838	0x0800BEBE	2800	Clk_Init() + 66	
002524	002842	0x0800B5A4	B510	RCC_GetFlagStatus(u8)	
002559	002877	0x0800BEBE	2800	Clk_Init() + 66	
002563	002881	0x0800B5A4	B510	RCC_GetFlagStatus(u8)	
002598	002916	0x0800BEBE	2800	Clk_Init() + 66	
002602	002920	0x0800B5A4	B510	RCC_GetFlagStatus(u8)	
002637	002955	0x0800BEBE	2800	Clk_Init() + 66	
002641	002959	0x0800B5A4	B510	RCC_GetFlagStatus(u8)	
002676	002994	0x0800BEBE	2800	Clk_Init() + 66	
002680	002998	0x0800B5A4	B510	RCC_GetFlagStatus(u8)	
002715	003033	0x0800BEBE	2800	Clk_Init() + 66	
002719	003037	0x0800B5A4	B510	RCC_GetFlagStatus(u8)	
002754	003072	0x0800BEBE	2800	Clk_Init() + 66	
002758	003076	0x0800B5A4	B510	RCC_GetFlagStatus(u8)	
002793	003111	0x0800BEBE	2800	Clk_Init() + 66	
002797	003115	0x0800B5A4	B510	RCC_GetFlagStatus(u8)	
002832	003150	0x0800BEBE	2800	Clk_Init() + 66	
002836	003154	0x0800B5A4	B510	RCC_GetFlagStatus(u8)	
002871	003189	0x0800BEBE	2800	Clk_Init() + 66	
002875	003193	0x0800B3C8	B510	RCC_USBCLKConfig(u32)	
002883	003201	0x0800BEC8	F44F	Clk_Init() + 76	
002885	003203	0x0800B5A4	B510	RCC_AOCCLKConfig(u32)	
002906	003224	0x0800BED0	2000	Clk_Init() + 84	
002908	003226	0x0800B37C	B510	RCC_PCLK2Config(u32)	
002923	003241	0x0800BED6	F44F	Clk_Init() + 90	
002925	003243	0x0800B334	B510	RCC_PCLK1Config(u32)	
002942	003260	0x0800BEBE	2000	Clk_Init() + 98	
002944	003262	0x0800B2E4	B510	RCC_MCLKConfig(u32)	
002959	003277	0x0800BEE4	2002	Clk_Init() + 104	
002961	003279	0x0800D70C	B510	FLASH_SetLatency(u32)	
002985	003303	0x0800BEEA	2000	Clk_Init() + 110	
002987	003305	0x0800D746	B510	FLASH_HalfCycleAccessCmd(u32)	
003009	003327	0x0800BEF0	2010	Clk_Init() + 116	
003011	003329	0x0800D77C	B510	FLASH_PrefetchBufferCmd(u32)	
003031	003349	0x0800BEBE	2002	Clk_Init() + 122	
003033	003351	0x0800B5AC	B510	RCC_SYSCFGConfig(u32)	
003053	003371	0x0800BEFC	B001	Clk_Init() + 128	
003054	003372	0x0800BF88	2100	main() + 16	
003057	003375	0x0800D88C	B538	NVIC_SetVectorTable(u32, u32)	
003075	003393	0x0800BF72	F44F	main() + 26	
003077	003395	0x0800D84C	B510	NVIC_PriorityGroupConfig(u32)	
003096	003414	0x0800BFCA	4876	main() + 34	

19.3 Embedded Trace Buffer (ETB)

The ETB is a small, circular on-chip memory area where trace information is stored during capture. It contains the data which is normally exported immediately after it has been captured from the ETM. The buffer can be read out through the JTAG port of the device once capture has been completed. No additional special trace port is required, so that the ETB can be read via J-Link. The trace functionality via J-Link is limited by the size of the ETB. While capturing runs, the trace information in the buffer will be overwritten every time the buffer size has been reached.

```

J-Link ARM
SEGGER J-Link Commander V3.72c ('?' for help)
Compiled Jul  4 2007 20:17:14
DLL version V3.72c, compiled Jul  4 2007 20:17:09
Firmware: J-Link compiled Jun 14 2007 14:36:33 ARM Rev.5
Hardware: V5.30
S/N : 1
Feature(s) : RDI, FlashBP, FlashDL, JFlash, GDB
Utarget = 3.1190
JTAG speed: 30 kHz
Info: CP15.0.0: 0x41069264: ARM, Architecture 5TEJ
Info: CP15.0.1: 0x1D192192: ICache: 32kB (4*256*32), DCache: 32kB (4*256*32)
Found 2 JTAG devices, Total IRLen = 8:
  Id of device #0: 0x1B900F0F
  Id of device #1: 0x17900F0F
Found ARM with core Id 0x17900F0F (ARM9)
  ETM V1.3: 8 pairs addr.comp, 8 data comp, 16 MM decs, 4 counters, sequencer
  ETB V1.0: 2048x24 bit RAM
J-Link>etb
ETB is present.
ID register      <ETB[0x001]> : 1B900F0F
RAM depth        <ETB[0x011]> : 00000800
RAM width        <ETB[0x021]> : 00000018
Status           <ETB[0x031]> : 00000008
RAM data         <ETB[0x041]> : 00CBB1B7
RAM read pointer <ETB[0x051]> : 00000000
RAM write pointer <ETB[0x061]> : 00000000
Trigger counter  <ETB[0x071]> : 00000000
Control          <ETB[0x081]> : 00000000
J-Link>

```

The result of the limited buffer size is that not more data can be traced than the buffer can hold. Because of this limitation, an ETB is not a fully- alternative to the direct access to an ETM via J-Trace.

19.4 Flash programming

J-Link / J-Trace comes with a DLL, which allows - amongst other functionalities - reading and writing RAM, CPU registers, starting and stopping the CPU, and setting breakpoints. The standard DLL does not have API functions for flash programming. However, the functionality offered can be used to program the flash. In that case, a flashloader is required.

19.4.1 How does flash programming via J-Link / J-Trace work?

This requires extra code. This extra code typically downloads a program into the RAM of the target system, which is able to erase and program the flash. This program is called RAM code and “knows” how to program the flash; it contains an implementation of the flash programming algorithm for the particular flash. Different flash chips have different programming algorithms; the programming algorithm also depends on other things such as endianness of the target system and organization of the flash memory (for example 1 * 8 bits, 1 * 16 bits, 2 * 16 bits or 32 bits). The RAM code requires data to be programmed into the flash memory. There are 2 ways of supplying this data: Data download to RAM or data download via DCC.

19.4.2 Data download to RAM

The data (or part of it) is downloaded to another part of the RAM of the target system. The Instruction pointer (R15) of the CPU is then set to the start address of the RAM code, the CPU is started, executing the RAM code. The RAM code, which contains the programming algorithm for the flash chip, copies the data into the flash chip. The CPU is stopped after this. This process may have to be repeated until the entire data is programmed into the flash.

19.4.3 Data download via DCC

In this case, the RAM code is started as described above before downloading any data. The RAM code then communicates with the host computer (via DCC, JTAG and J-Link / J-Trace), transferring data to the target. The RAM code then programs the data into flash and waits for new data from the host. The WriteMemory functions of J-Link / J-Trace are used to transfer the RAM code only, but not to transfer the data. The CPU is started and stopped only once. Using DCC for communication is typically faster than using WriteMemory for RAM download because the overhead is lower.

19.4.4 Available options for flash programming

There are different solutions available to program internal or external flashes connected to ARM cores using J-Link / J-Trace. The different solutions have different fields of application, but of course also some overlap.

19.4.4.1 J-Flash - Complete flash programming solution

J-Flash is a stand-alone Windows application, which can read / write data files and program the flash in almost any ARM system. J-Flash requires an extra license from SEGGER.

19.4.4.2 RDI flash loader: Allows flash download from any RDI-compliant tool chain

RDI (Remote debug interface) is a standard for “debug transfer agents” such as J-Link. It allows using J-Link from any RDI compliant debugger. RDI by itself does not include download to flash. To debug in flash, you need to somehow program your application program (debuggee) into the flash. You can use J-Flash for this purpose, use the flash loader supplied by the debugger company (if they supply a matching flash loader) or use the flash loader integrated in the J-Link RDI software. The RDI software as well as the RDI flash loader require licenses from SEGGER.

19.4.4.3 Flash loader of compiler / debugger vendor such as IAR

A lot of debuggers (some of them integrated into an IDE) come with their own flash loaders. The flash loaders can of course be used if they match your flash configuration, which is something that needs to be checked with the vendor of the debugger.

19.4.4.4 Write your own flash loader

Implement your own flash loader using the functionality of the JLinkARM.dll as described above. This can be a time consuming process and requires in-depth knowledge of the flash programming algorithm used as well as of the target system.

19.5 J-Link / J-Trace firmware

The heart of J-Link / J-Trace is a microcontroller. The firmware is the software executed by the microcontroller inside of the J-Link / J-Trace. The J-Link / J-Trace firmware sometimes needs to be updated. This firmware update is performed automatically as necessary by the JLinkARM.dll.

19.5.1 Firmware update

Every time you connect to J-Link / J-Trace, JLinkARM.dll checks if its embedded firmware is newer than the one used the J-Link / J-Trace. The DLL will then update the firmware automatically. This process takes less than 3 seconds and does not require a reboot.

It is recommended that you always use the latest version of JLinkARM.dll.

```
J-Link V6.14h
SEGGER J-Link Commander V6.14h (Compiled May 10 2017 18:23:19)
DLL version V6.14h, compiled May 10 2017 18:22:45

Connecting to J-Link via USB...Updating firmware: J-Link Pro V4 compiled Apr 21 2017 11:15:52
Replacing firmware: J-Link Pro V4 compiled Feb 21 2017 14:10:35
Waiting for new firmware to boot
New firmware booted successfully
O.K.
Firmware: J-Link Pro V4 compiled Apr 21 2017 11:15:52
Hardware version: V4.00
S/N: 174402383
License(s): RDI, FlashBP, FlashDL, JFlash, GDB
IP-Addr: DHCP (no addr. received yet)
VTref = 0.000V

Type "connect" to establish a target connection, '?' for help
J-Link>
```

In the screenshot:

- The red box identifies the new firmware.
- The green box identifies the old firmware which has been replaced.

19.5.2 Invalidating the firmware

Downdating J-Link / J-Trace is not performed automatically through an old JLinkARM.dll. J-Link / J-Trace will continue using its current, newer firmware when using older versions of the JLinkARM.dll.

Note

Downdating J-Link / J-Trace is not recommended, you do it at your own risk!
Note also the firmware embedded in older versions of JLinkARM.dll might not execute properly with newer hardware versions.

To downgrade J-Link / J-Trace, you need to invalidate the current J-Link / J-Trace firmware, using the command `exec InvalidateFW` (first red box) .

In the screenshot, the yellow box contains information about the formerly used J-Link / J-Trace firmware version, which is invalidated. Use an application (for example JLink.exe) which uses the desired version of JLinkARM.dll. This automatically replaces the invalidated firmware with its embedded firmware.

This is also show in the screenshot, were the invalidated firmware (2nd red box) is replaced with the one provided by the currently used J-Link DLL (green box).

Chapter 20

Designing the target board for trace

This chapter describes the hardware requirements which have to be met by the target board.

20.1 Overview of high-speed board design

Failure to observe high-speed design rules when designing a target system containing an ARM Embedded Trace Macrocell (ETM) trace port can result in incorrect data being captured by J-Trace. You must give serious consideration to high-speed signals when designing the target system.

The signals coming from an ARM ETM trace port can have very fast rise and fall times, even at relatively low frequencies.

Note

These principles apply to all of the trace port signals (TRACEPKT[0:15], PIPES-TAT[0:2], TRACESYNC), but special care must be taken with TRACECLK.

20.1.1 Avoiding stubs

Stubs are short pieces of track that tee off from the main track carrying the signal to, for example, a test point or a connection to an intermediate device. Stubs cause impedance discontinuities that affect signal quality and must be avoided.

Special care must therefore be taken when ETM signals are multiplexed with other pin functions and where the PCB is designed to support both functions with differing tracking requirements.

20.1.2 Minimizing Signal Skew (Balancing PCB Track Lengths)

You must attempt to match the lengths of the PCB tracks carrying all of TRACECLK, PIPES-TAT, TRACESYNC, and TRACEPKT from the ASIC to the mictor connector to be within approximately 0.5 inches (12.5mm) of each other. Any greater differences directly impact the setup and hold time requirements.

20.1.3 Minimizing Crosstalk

Normal high-speed design rules must be observed. For example, do not run dynamic signals parallel to each other for any significant distance, keep them spaced well apart, and use a ground plane and so forth. Particular attention must be paid to the TRACECLK signal. If in any doubt, place grounds or static signals between the TRACECLK and any other dynamic signals.

20.1.4 Using impedance matching and termination

Termination is almost certainly necessary, but there are some circumstances where it is not required. The decision is related to track length between the ASIC and the JTAG+Trace connector, see *Terminating the trace signal* on page 397 for further reference.

20.2 Terminating the trace signal

To terminate the trace signal, you can choose between three termination options:

- Matched impedance.
- Series (source) termination.
- DC parallel termination.

Matched impedance

Where available, the best termination scheme is to have the ASIC manufacturer match the output impedance of the driver to the impedance of the PCB track on your board. This produces the best possible signal.

Series (source) termination

This method requires a resistor fitted in series with signal. The resistor value plus the output impedance of the driver must be equal to the PCB track impedance.

DC parallel termination

This requires either a single resistor to ground, or a pull-up/pull-down combination of resistors (Thevenin termination), fitted at the end of each signal and as close as possible to the JTAG+Trace connector. If a single resistor is used, its value must be set equal to the PCB track impedance. If the pull-up/pull-down combination is used, their resistance values must be selected so that their parallel combination equals the PCB track impedance.

Caution:

At lower frequencies, parallel termination requires considerably more drive capability from the ASIC than series termination and so, in practice, DC parallel termination is rarely used.

20.2.1 Rules for series terminators

Series (source) termination is the most commonly used method. The basic rules are:

1. The series resistor must be placed as close as possible to the ASIC pin (less than 0.5 inches).
2. The value of the resistor must equal the impedance of the track minus the output impedance of the output driver. So for example, a 50 PCB track driven by an output with a 17 impedance, requires a resistor value of 33.
3. A source terminated signal is only valid at the end of the signal path. At any point between the source and the end of the track, the signal appears distorted because of reflections. Any device connected between the source and the end of the signal path therefore sees the distorted signal and might not operate correctly. Care must be taken not to connect devices in this way, unless the distortion does not affect device operation.

20.3 Signal requirements

The table below lists the specifications that apply to the signals as seen at the JTAG+Trace connector.

Signal	Value
Fmax	200MHz
Ts setup time (min.)	2.0ns
Th hold time (min.)	1.0ns
TRACECLK high pulse width (min.)	1.5ns
TRACECLK high pulse width (min.)	1.5ns

Chapter 21

Semihosting

J-Link supports semihosting for ARM targets. This chapter explains what semihosting is, what it can be used for and how to enable semihosting in different environments.

21.1 Introduction

Semihosting is a mechanism for ARM based target devices to provide a way to communicate/interact with a host system (the PC where the debugger is running on) to allow different operations to be performed /automatized. Typical use-cases for semihosting are:

- Calls to `printf()` in the target to be forwarded to the host system and then output in a console/terminal on the host
- Calls to `scanf()` to retrieve user input entered in a console/terminal on the host and then being received and evaluated by the target
- Performing file I/O operations on the host system (reading / writing files)
- Writing a flashloader that reads the bin file to be flashed from the host system and performs the flashing operation chunk-wise

Most standard I/O libraries for embedded applications come with semihosting implementations for `printf()` and `scanf()`.

21.1.1 Advantages

- Provides standardized commands for file I/O operations on the host, allowing relatively complex operations with minimal logic in the target application
- Does not need chip-specific hardware capabilities
- Semihosting handling is natively supported by many debuggers/IDEs, for example GDB.

21.1.2 Disadvantages

- Target CPU is halted on each semihosting command, debugger evaluates the semihosting command and restarts the CPU. This affects real-time behavior of the system.

21.2 Debugger support

If semihosting is supported or not depends on the actual debugger being used. Most modern IDEs / Debuggers support semihosting. The following debuggers / IDEs are known to support semihosting:

- J-Link Debugger
- J-Link GDBServer + GDB
- SEGGER Embedded Studio
- J-Link RDI (and therefor most RDI compliant debuggers)
- IAR Embedded Workbench for ARM
- Keil MDK-ARM
- ARM AXD

21.3 Implementation

In general, there are two ways of implement semihosting which are explained in the following:

- SVC instruction (called SWI on legacy CPUs)
- Breakpoint instruction
- J-Link GDBServer optimized version

21.3.1 SVC instruction

Inside printf() calls etc. that shall perform semihosting, an SVC instruction is present which causes the CPU to issue a software interrupt and jump to the SVC exception handler. The debugger usually sets a breakpoint on the first instruction of the SVC exception handler or sets a vector catch that has the same effect but does not waste one hardware breakpoint. If vector catch is available depends on the CPU. Once the CPU has been halted, the debugger can identify the cause of the SVC exception by analyzing the SVC instruction that caused the exception. In the instruction there is a SVC reason/number encoded. The number may differ if the CPU was in ARM or Thumb mode when the SVC instruction was executed. The following SVC reasons are reserved for semihosting:

- ARM mode: 0x123456
- Thumb mode: 0xAB

Once the debugger has performed the semihosting operation and evaluated the command, it will restart the target CPU right behind the SVC instruction that caused the semihosting call. So it is debuggers responsibility to perform the exception return.

Disadvantages

If the SVC instruction is also used by the user application or a operating system on the target, the CPU will be halted on every semihosting exception and be restarted by the debugger. This affects real-time behavior of the target application.

21.3.2 Breakpoint instruction

A breakpoint instruction is compiled into the code that makes use of semihosting (usually somewhere inside the printf() function in a library). The CPU halts as soon as the breakpoint instruction is hit and allows the debugger to perform semihosting operations. Once the CPU has been halted, the debugger is able to determine the halt reason by analyzing the breakpoint instruction that caused the halt. In the breakpoint instruction, a "halt reason" can be encoded. The halt reason may differ if the breakpoint instruction is an ARM instruction or Thumb instruction. The following halt reasons are reserved for semihosting:

- ARM mode: 0x123456
- Thumb mode: 0xAB

Disadvantages

Having a breakpoint instruction compiled in a library call will make it necessary to have different compile options for debug and release configurations as the target application will not run stand-alone, without debugger intervention.

21.3.3 J-Link GDBServer optimized version

When using J-Link GDBServer with a GDB-based environment, there is a third implementation for semihosting available which is a hybrid of the other implementations, combining the advantages of both. With this implementation, an SVC instruction with the usual SVC reason is used to issue a semihosting call but the debugger does not set a breakpoint or vector catch on the start of the SVC exception handler. Instead, the SVC exception handler provides some code that detects if the reason was a semihosting call, if yes it immediately performs a return from exception on which the debugger has set a hardware breakpoint. This allows the application to continue normally in case no debugger is connected and han-

dling the semihosting call. It also inhibits the CPU from being halted on each non-semihosting call, preserving the real-time behavior of the target application.

Advantages

Application also runs stand-alone (no debugger connected). Real-time behavior of the application is preserved.

Disadvantages

One hardware breakpoint is not available for debugging / stepping as it is permanently used while semihosting is enabled. Only works with J-Link GDBServer as other debuggers do not support this specialized version.

21.3.3.1 SVC exception handler sample code

In the following, some sample code for the SVC handler, prepared to be used with J-Link GDBServer optimized semihosting, is given:

```

SVC_Handler:
    ;
    ; For semihosting R0 and R1 contain the semihosting information and may not
    ; be changed before semihosting is handled.
    ; If R2 and R3 contain values for the SVC handler or need to be restored for
    ; the calling function, save them on the stack.
    ;
    #if SAVE_REGS_IN_SVC
        PUSH {R2,R3}
    #endif
    BIC R2, LR, #0xFFFFFFFF
    CMP R2, #0x01 ; Check whether we come from Thumb or ARM mode
    BNE CheckSemiARM
CheckSemiThumb:
    #if BIG_ENDIAN
        LDRB R2, [LR, #-2]
    #else
        LDRB R2, [LR, #-1]
    #endif
    LDR R3, _DataTable2
    CMP R2, R3 ; ARM semihosting call?
    BNE DoSVC
    B SemiBreak
CheckSemiARM:
    LDR R2, [LR, #-4]
    BIC R2, R2, #0xFF000000
    LDR R3, _DataTable1
    CMP R2, R3 ; Thumb semihosting call?
    BNE DoSVC
    #if SAVE_REGS_IN_SVC
        POP {R2,R3} ; Restore regs needed for semihosting
    #endif
SemiBreak: ; Debugger will set a breakpoint here and perform exception return
    NOP
    MOVS R0, #+0 ; Make sure we have a valid return value in case
    BX LR ; debugger is not connected
DoSVC:
    ;
    ; Customer specific SVC handler code
    ;
    MOVS R0, #+0 ; Replace this code with your SVC Handler
    BX LR

_DataTable1:
    .word 0x00123456
_DataTable2:
    .byte 0xAB
    .byte 0x00

```

```
.byte 0x00  
.byte 0x00
```

21.4 Communication protocol

Semihosting defines a standardized set of semihosting commands that need to be supported by a debugger, claiming that it supports semihosting. In the following, the communication protocol for semihosting as well as the specified commands are explained.

21.4.1 Register R0

Right before the operation that halts the CPU for semihosting, is performed, the target application needs to prepare CPU register R0 and (depending on the command) also some other CPU registers. On halt, R0 will hold the semihosting command, so the debugger can determine further parameters and operation to be performed, from it.

Command	R0 value
SYS_OPEN	0x01
SYS_CLOSE	0x02
SYS_WRITEC	0x03
SYS_WRITE0	0x04
SYS_WRITE	0x05
SYS_READ	0x06
SYS_READC	0x07
SYS_ISTTY	0x09
SYS_SEEK	0x0A
SYS_FLEN	0x0C
SYS_REMOVE	0x0E
SYS_RENAME	0x0F
SYS_GET_CMDLINE	0x15
SYS_EXIT	0x18

21.4.2 Command SYS_OPEN (0x01)

Opens a file on the host system. Register R1 holds a pointer to an address on the target, that specifies a 3-word (32-bit each) buffer where additional information for the command can be found.

Word 0

Pointer to a null-terminated string that specifies the file to open. Special: The string ":tt" specifies the console input/output (usually stdin / stdout). Which one is selected depends on if the stream is opened for reading or writing.

Word 1

A number that specifies how the file is to be opened (reading/writing/appending etc.). In the following, the corresponding ISO C fopen() modes for the numbers are listed. ISO C fopen() modes

Word1	ISO C fopen() mode
0	r
1	rb
2	r+
3	r+b

Word1	ISO C fopen() mode
4	w
5	wb
6	w+
7	w+b
8	a
9	ab
10	a+
11	a+b

Word 2

Integer that specifies the length of the string (excluding the terminating null character) pointed to by word 0.

Return value

Operation result is written to register R0 by the debugger.

Value	Meaning
≠ 0	O.K., handle of the file (needed for SYS_CLOSE etc.)
= -1	Error

21.4.3 Command SYS_CLOSE (0x02)

Closes a file on the host system. Register R1 holds a pointer to an address on the target, that specifies a 1-word (32-bit each) buffer where additional information for the command can be found.

Word 0

Handle of the file retrieved on SYS_OPEN

Return value

Operation result is written to register R0 by the debugger.

Value	Meaning
= 0	O.K.
= -1	Error

21.4.4 Command SYS_WRITEC (0x03)

Writes a single character to the debug channel on the host system (stdout in most cases). Register R1 holds a pointer to an address on the target, that specifies a 1-word (32-bit each) buffer where additional information for the command can be found.

Word 0

Pointer to the character to be written.

Return value

None

21.4.5 Command SYS_WRITE0 (0x04)

Writes a null-terminated string (excluding the null character) to the debug channel on the host system. Register R1 holds a pointer to the string that shall be written.

Return value

None

21.4.6 Command SYS_WRITE (0x05)

Writes a given number of bytes to a file that has been previously opened via SYS_OPEN . Exceptions: Handle 0-2 which specify stdin, stdout, stderr (in this order) do not require to be opened with SYS_OPEN before used. This command behaves compatible to the ANSI C function fwrite() meaning that writing is started at the last position of the write pointer on the host. Register R1 holds a pointer to an address on the target, that specifies a 3-word (32-bit each) buffer where additional information for the command can be found.

Word 0

Handle of the file to be written.

Word 1

Pointer to the data on the target, to be written.

Word 2

Number of bytes to write

Return value

Operation result is written to register R0 by the debugger.

Value	Meaning
= 0	O.K.
≠ 0	Number of bytes to write left (in case not all bytes could be written)

21.4.7 Command SYS_READ (0x06)

Reads a given number of bytes from a file that has been previously opened via SYS_OPEN . Exceptions: Handle 0-2 which specify stdin, stdout, stderr (in this order) do not require to be opened with SYS_OPEN before used. This command behaves compatible to the ANSI C function fread() meaning that reading is started at the last position of the read pointer on the host. Register R1 holds a pointer to an address on the target, that specifies a 3-word (32-bit each) buffer where additional information for the command can be found.

Word 0

Handle of the file to be read.

Word 1

Pointer to a buffer on the target where data from file is written to.

Word 2

Number of bytes to read

Return value

Operation result is written to register R0 by the debugger.

Value	Meaning
= 0	O.K.
≠ 0	Number of bytes to read left (in case not all bytes could be read). If identical to the number of bytes to be read, read pointer was pointing to end-of-file and no bytes have been read.

21.4.8 Command SYS_READC (0x07)

Reads a single character from the debug channel on the host (usually stdin). Register R1 is set to 0.

Return value

Character that has been read is written to register R0.

21.4.9 Command SYS_ISTTY (0x09)

Checks if a given handle is an "interactive device" (stdin, stdout, ...). Register R1 holds a pointer to an address on the target, that specifies a 1-word (32-bit each) buffer where additional information for the command can be found.

Word 0

Handle of the file to be checked.

Return value

Operation result is written to register R0 by the debugger.

Value	Meaning
= 1	O.K., given handle is an interactive device.
= 0	O.K., given handle is not an interactive device.
Else	Error

21.4.10 Command SYS_SEEK (0x0A)

Moves the filepointer of a file previously opened via SYS_OPEN to a specific position in the file. Behaves compliant to the ANSI C function fseek(). Register R1 holds a pointer to an address on the target, that specifies a 2-word (32-bit each) buffer where additional information for the command can be found.

Word 0

Handle of the file.

Word 1

Position of the filepointer inside the file, to set to.

Return value

Operation result is written to register R0 by the debugger.

Value	Meaning
= 0	O.K.
≠ 0	Error

21.4.11 Command SYS_FLEN (0x0C)

Retrieves the size of a file, previously opened by SYS_OPEN , in bytes. Register R1 holds a pointer to an address on the target, that specifies a 1-word (32-bit each) buffer where additional information for the command can be found.

Word 0

Handle of the file.

Return value

Operation result is written to register R0 by the debugger.

Value	Meaning
≥ 0	File size in byte
$= -1$	Error

21.4.12 Command SYS_REMOVE (0x0E)

Deletes a file on the host system. Register R1 holds a pointer to an address on the target, that specifies a 2-word (32-bit each) buffer where additional information for the command can be found.

Word 0

Pointer to a null-terminated string that specifies the path + file to be deleted.

Word 1

Length of the string pointed to by word 0 .

Return value

Operation result is written to register R0 by the debugger.

Value	Meaning
$= 0$	O.K.
$\neq 0$	Error

21.4.13 Command SYS_RENAME (0x0F)

Renames a file on the host system. Register R1 holds a pointer to an address on the target, that specifies a 4-word (32-bit each) buffer where additional information for the command can be found.

Word 0

Pointer to a null-terminated string that specifies the old name of the file.

Word 1

Length of the string (without terminating null-character) pointed to by word 0 .

Word 2

Pointer to a null-terminated string that specifies the new name of the file.

Word 3

Length of the string (without terminating null-character) pointed to by word 2 .

Return value

Operation result is written to register R0 by the debugger.

Value	Meaning
= 0	O.K.
≠ 0	Error

21.4.14 Command SYS_GET_CMDLINE (0x15)

Gets the command line (argc, argv) from the process on the host system as a single string. argv elements will be separated by spaces. Register R1 holds a pointer to an address on the target, that specifies a 2-word (32-bit each) buffer where additional information for the command can be found.

Word 0

Pointer to a buffer on the target system to store the command line to.

Word 1

Size of the buffer in bytes.

Return value

After the operation, word 1 will hold the length of the command line string. Operation result is written to register R0 by the debugger.

Value	Meaning
= 0	O.K.
≠ 0	Error

21.4.15 Command SYS_EXIT (0x18)

Used to tell the debugger if an application exited/completed with success or error. Usually, this also ends the debug session automatically. Register R1 is one of the following values:

Exit code	Meaning
0x20026	Application exited normally.
0x20023	Application exited with error.

Return value

None.

21.5 Enabling semihosting in J-Link GDBServer

By default, semihosting is disabled in J-Link GDBServer. Depending on the mechanism to be used, different setups are necessary

21.5.1 SVC variant

The following commands need to be added to the gdbinit file that is executed at the start of a debug session:

```
monitor semihosting enable
monitor semihosting breakOnError
monitor semihosting IOclient 3
monitor semihosting setargs "<argv>" (in case SYS_GET_CMDLINE command is used)
```

For more detailed information about the monitor commands supported by J-Link GDBServer, please refer to *Supported remote (monitor) commands* on page 102.

21.5.2 Breakpoint variant

The following commands need to be added to the gdbinit file that is executed at the start of a debug session:

```
monitor semihosting enable
```

21.5.3 J-Link GDBServer optimized variant

The following commands need to be added to the gdbinit file that is executed at the start of a debug session:

```
monitor semihosting enable <AddrSemiBreak>
```

Please also make sure that an appropriate SVC exception handler is linked in the application. For sample code, please refer to *SVC exception handler sample code* on page 403.

21.6 Enabling Semihosting in J-Link RDI + AXD

This semihosting mechanism can be disabled or changed by the following debugger internal variables:

\$semihosting_enabled

Set this variable to 0 to disable semihosting. If you are debugging an application running from ROM, this allows you to use an additional watchpoint unit.

Set this variable to 1 to enable semihosting. This is the default.

Set this variable to 2 to enable Debug Communications Channel (DCC) semihosting.

The S bit in \$vector_catch has no effect unless semihosting is disabled.

\$semihosting_vector

This variable controls the location of the breakpoint set by J-Link RDI to detect a semihosted SWI. It is set to the SWI entry in the exception vector table () by default.

21.6.1 Using SWIs in your application

If your application requires semihosting as well as having its own SWI handler, set \$semihosting_vector to an address in your SWI handler. This address must point to an instruction that is only executed if your SWI handler has identified a call to a semihosting SWI. All registers must already have been restored to whatever values they had on entry to your SWI handler.

Chapter 22

Environmental Conditions & Safety

22.1 J-Link

- Operating temperature +5°C ... +60°C
- Storage temperature -20°C ... +65 °C
- Relative humidity (non-condensing) Max. 90% rH
- For indoor use only. Use on current-limited USB ports only.
- J-Link WiFi only: This device is test equipment and consequently is exempt from part 15 of the FCC rules under section 15.103.

22.1.1 Affected models

If not otherwise mentioned, the following models are affected by these safety notes:

- J-Link BASE
- J-Link PLUS
- J-Link ULTRA+
- J-Link WiFi
- J-Link PRO
- J-Link BASE Compact
- J-Link PLUS Compact

22.2 Flasher

- Operating temperature +5°C ... +60°C (+5°C ... +45°C for Flasher Portable PLUS when charging internal battery)
- Storage temperature -20°C ... +65 °C
- Relative humidity (non-condensing) Max. 90% rH
- For indoor use only. Use on current-limited USB ports only.

22.2.1 Affected models

If not otherwise mentioned, the following models are affected by these safety notes:

- Flasher ARM
- Flasher PRO
- Flasher Portable
- Flasher Portable PLUS
- Flasher Secure

22.3 J-Trace

- Operating temperature +5°C ... +60°C
- Storage temperature -20°C ... +65 °C
- Relative humidity (non-condensing) Max. 90% rH
- For indoor use only. Use on current-limited USB ports only.

22.3.1 Affected models

If not otherwise mentioned, the following models are affected by these safety notes:

- J-Trace PRO Cortex-M
- J-Trace PRO Cortex

Chapter 23

Support and FAQs

This chapter contains troubleshooting tips as well as solutions for common problems which might occur when using J-Link / J-Trace. There are several steps you can take before contacting support. Performing these steps can solve many problems and often eliminates the need for assistance. This chapter also contains a collection of frequently asked questions (FAQs) with answers.

23.1 Measuring download speed

Test environment

JLink.exe has been used for measurement performance. The hardware consisted of:

- PC with 2.6 GHz Pentium 4, running Win2K
- USB 2.0 port
- USB 2.0 hub
- J-Link
- Target with ARM7 running at 50MHz

23.2 Troubleshooting

23.2.1 General procedure

If you experience problems with J-Link / J-Trace, you should follow the steps below to solve these problems:

- Close all running applications on your host system.
- Disconnect the J-Link / J-Trace device from USB.
- Disable power supply on the target.
- Re-connect J-Link / J-Trace with the host system (attach USB cable).
- Enable power supply on the target.
- Try your target application again. If the problem remains continue the following procedure.
- Close all running applications on your host system again.
- Disconnect the J-Link / J-Trace device from USB.
- Disable power supply on the target.
- Re-connect J-Link / J-Trace with the host system (attach the USB cable).
- Enable power supply on the target.
- Start JLink.exe .
- If JLink.exe displays the J-Link / J-Trace serial number and the target processor's core ID, the J-Link / J-Trace is working properly and cannot be the cause of your problem.
- If the problem persists and you own an original product (not an OEM version), see section *Contacting support* .

23.3 Contacting support

Before contacting support, make sure you tried to solve your problem by following the steps outlined in section *General procedure* on page 419. You may also try your J-Link / J-Trace with another PC and if possible with another target system to see if it works there. If the device functions correctly, the USB setup on the original machine or your target hardware is the source of the problem, not J-Link / J-Trace. If you need to contact support, send the following information to

support@segger.com :

- A detailed description of the problem.
- J-Link/J-Trace serial number.
- Output of JLink.exe if available.
- Your findings of the signal analysis.
- Information about your target hardware (processor, board, etc.).

J-Link / J-Trace is sold directly by SEGGER or as OEM-product by other vendors. SEGGER can support only official SEGGER products.

23.3.1 Contact Information

SEGGER Microcontroller GmbH

Ecolab-Allee 5
D-40789 Monheim am Rhein

Germany

Tel. +49-2173-99312-0
Fax. +49-2173-99312-28
E-mail: support@segger.com
Internet: www.segger.com