

MULTI-APPLICATION SERIES

SMA & SMAT

INTRODUCTION

The Sonitron Multi-Application (SMA) series are specifically developed to meet a wide range of requirements in sound pressure, dimensions and mounting methods. This series produce highly reliable audible signals, giving either an extremely clear penetrating tone or a soft sound output. Both, buzzers and transducers, are available in five sizes, 13 mm, 17 mm, 21 mm, 24 mm and 30 mm. All SMA products are manufactured to meet various mounting styles such as through-hole or surface mounting technologies (SMD). Therefore they are equipped with either pin or SMD terminals.

The Multi-Application series present the following advantages:

- The octagonal housing provides alignment with pick & place machines for SMD models, which are packed in trays and protected with a heat resistant label for automatic soldering.
- The miniature models SMA-13 and SMA-17 offer a high sound pressure level together with a clear audible tone.
- The LT-versions of the models SMA-13, SMA-17 and SMA-21 generate an increased sound output. The LC-versions of the same models operate at extremely low current consumption; ideal for battery operated applications.
- The LV versions of the model SMA-21 generate an extremely loud sound output at very low battery voltage starting at 2 Vdc up to 6 Vdc.
- Because of the same case style for buzzers and transducers with different pin pitches per model, the user is offered a great deal of flexibility and can switch over to a buzzer or transducer at any time.
- The piezo audio technology can be qualified as solid state, highly reliable, without EMI and is able to withstand temperatures from -40°C to $+85^{\circ}\text{C}$. The MTBF exceeds in reality several times the figure indicated in this catalogue. Lifetime depends on different factors and is described more in detail in the addendum.



SELECTION GUIDE

The selection of an acoustic signal can be complex. The list below indicates the use of a certain buzzer model at a certain distance and frequency. It is important to take into account that every application is different and that the perception of a sound is very subjective.

frequency	Average distance from the source in free air				
	0 to 1m	1 to 2m	2 to 3m	3 to 4m	4 to 5m
2 kHz to 3 kHz	SMAT-13 SMAT-17 SMA-13 SMA-17	SMAT-13 SMAT-17 SMAT-21 SMA-13LC SMA-17LC SMA-17L SMA-21LV	SMAT-13 SMAT-17 SMAT-21 SMA-13LC SMA-17LC SMA-17L SMA-21LV	SMAT-30 SMA-21LV SMA-30 SMA-30L	SMAT-30 SMA-21LV SMA-30 SMA-30L
2.5 kHz to 3 kHz	SMAT-17 SMA-17LC SMA-17L SMA-21 SMA-21LC SMA-21L SMA-21LV	SMAT-17 SMA-17LC SMA-17L SMA-21 SMA-21LC SMA-21L SMA-21LV	SMA-24 SMA-24L SMA-17LC SMA-17L SMA-21LV	SMA-24 SMA-24L SMA-17LC SMA-17L SMA-21LV	SMA-24 SMA-24L SMA-17LC SMA-17L SMA-21LV
3 kHz to 3.8 kHz	SMAT-17 SMAT-21 SMA-17 SMA-17LT SMA-21 SMA-21LT	SMAT-17 SMAT-21 SMA-17 SMA-17LT SMA-21 SMA-21LT	SMAT-17 SMAT-21 SMAT-24 SMAT-30 SMAC-25 SMA-17LT SMA-17LC SMA-17L SMA-21LT SMA-21LC SMA-21L SMA-30 SMA-30L	SMAT-17 SMAT-21 SMAT-24 SMAT-30 SMAC-25 SMA-17LT SMA-17LC SMA-17L SMA-21LT SMA-21LC SMA-21L SMA-30 SMA-30L	SMAT-17 SMAT-21 SMAT-24 SMAT-30 SMAC-25 SMA-17LT SMA-17LC SMA-17L SMA-21LT SMA-21LC SMA-21L SMA-30 SMA-30L

SMA SERIES

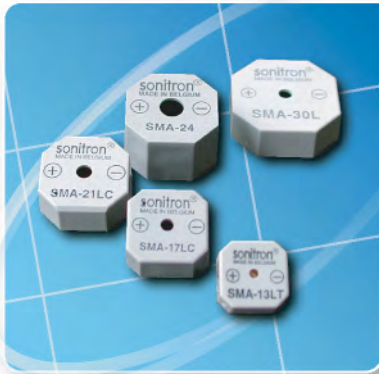

The Sonitron Multi-Application buzzers are low cost commercial grade components for large volume applications. The SMA series are designed to meet various requirements such as current consumption, voltage, sound pressure, mounting methods, connection, dimensions and packaging. They are available in five sizes: 13 mm, 17 mm, 21 mm, 24 mm and 30 mm.

The buzzers have a built-in oscillator generating their working frequency. They produce a highly reliable audible tone signal, giving either an extremely clear and penetrating tone or a soft sound for non-aggressive signals.

ADVANTAGES & APPLICATIONS

ADVANTAGES :

- Octagonal form
- Models with different pin pitches
- Light but solid state construction
- Little power consumption, especially the Extra loud LC-versions
- Wide voltage range (1,5V to 24V)
- Easy mountable
- SMA-13 and SMA-17 for applications with limited space
- SMD models with heat resistant label for protection during automatic soldering
- Automatic pick & place

APPLICATIONS :

- Automatic doors
- Alarms
- Gas & metal detectors
- Weighing & measuring equipment
- Medical instrumentation
- Timers & clocks
- Control instrumentation & systems
- Copiers
- Automobiles & trucks
- Games & toys
- Computer peripherals
- Cash registers

SPECIFICATIONS

Model	SPL * (dB(A))	Frequency (+/-15%) Hz)	Operating Voltage (min.-max.)	Operating current (mA)	Weight (g)
SMA-13	75	3000	1.5 to 24	1.8	1
SMA-13LT	82	3000	1.5 to 15	11.6	1
SMA-13LC	81	3000	1.5 to 15	0.7	1
SMA-17	82	3000	1.5 to 24	3.3	2
SMA-17L	88	3000	1.5 to 24	5	2
SMA-17LT	86	3000	1.5 to 15	15	2
SMA-17LC	89	3500	1.5 to 15	0.8	2
SMA-21	85	3300	1.5 to 24	3.8	2.5
SMA-21L	91	3300	1.5 to 24	5	2.5
SMA-21LT	90	3300	1.5 to 15	12.5	2.5
SMA-21LC	91	3800	1.5 to 15	1.1	2.5
SMA-21LV	87 @ 3V	3000	2 to 6	13 @ 3V	2.5
SMA-24	92	3000	1.5 to 24	4.2	4
SMA-24L	98	3000	1.5 to 15	6.7	4
SMAI-24	92	**3500	5 to 24	6.2	4
SMA-30	87	2500	1.5 to 24	4.1	5
SMA-30L	97 @ 9V	2500	3 to 9	5 @ 9V	5

* All measurements are made in free air @ 21°C @ 30cm @ 12Vdc (Except for the SMA-21LV & SMA-30 L). Buzzers soldered on a PCB board with dimensions of 24cmx11cm.

** SMAI 24: intermittent pulse rate of 5Hz (@ 15Vdc). All the other models have a continuous tone.

Operating temperature	-20°C to +70°C
Storage temperature	-40°C to +85°C
Life time (@ 21°C)	@12Vdc (L-version working @ 6Vdc) continuous use min. 100 hours The SMA-21 LV (PIN/SMD) working @ 3Vdc in continuous use: min.24 hours. All tests are made @ 20°C mounted on PCB (expected life time curve in addendum)
Case material	ABS (UL rating: 94 HB) for pin-versions, SMA-13/21/30 PBT (UL rating: 94 HB) for pin versions, SMA-17/24 PPS (UL rating: 94 V0/5V) for SMD-versions, SMA-13/17/21/24/30
Standard colour of case	Grey

ELECTRICAL PARAMETERS

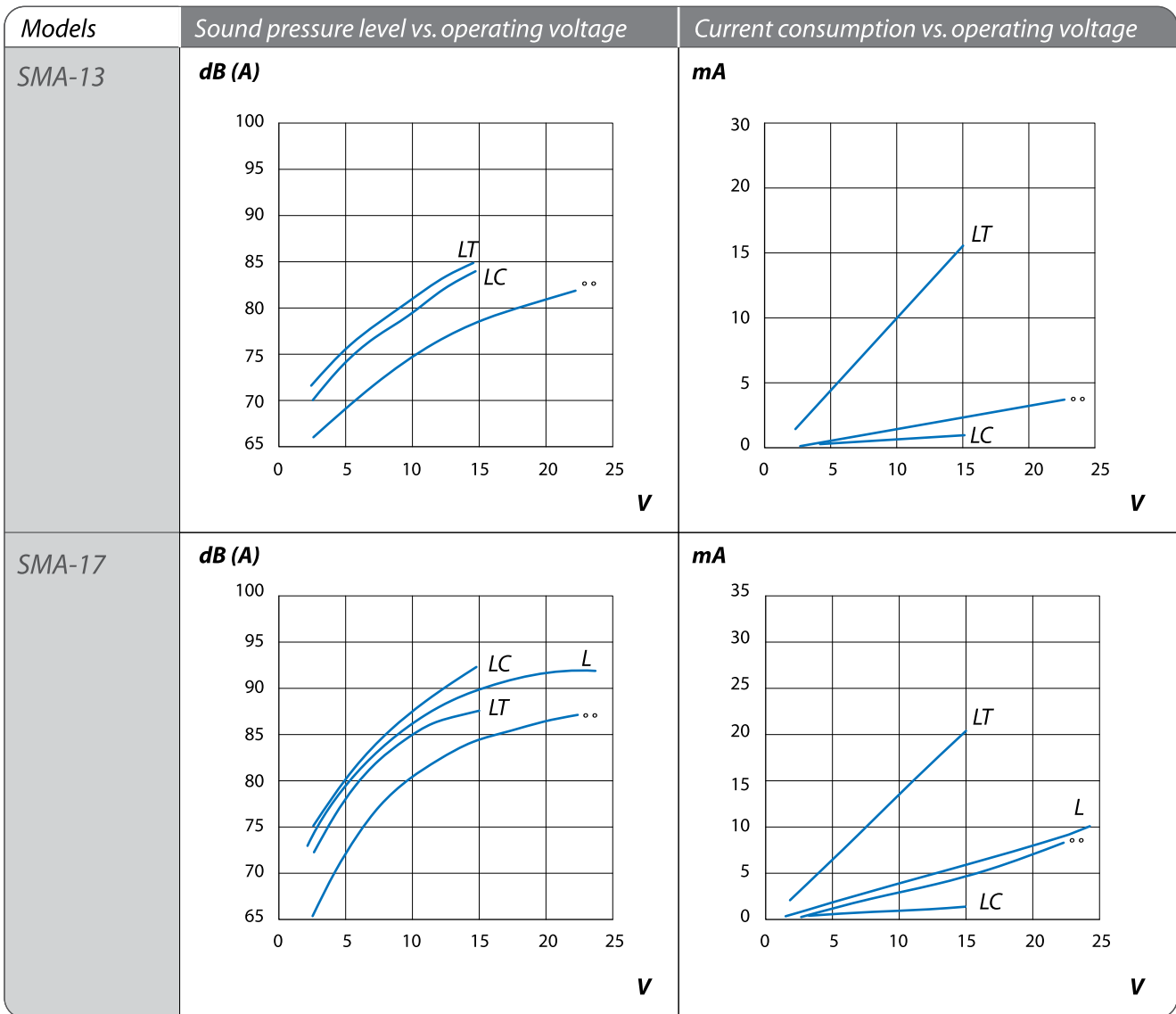

All measurements are made @ 30 cm in free air @ 21°C.
°°: standard versions, respectively SMA-13, SMA-17.

Models	Sound pressure level vs. operating voltage	Current consumption vs. operating voltage
SMA-21	<p>dB (A)</p>	<p>mA</p>
SMA-24	<p>dB (A)</p>	<p>mA</p>
SMA-30	<p>dB (A)</p>	<p>mA</p>

All measurements are made @ 30 cm in free air @ 21°C.
 °°: standard versions, respectively SMA-21, SMA-24, SMA-30.

PRODUCT CODIFICATION

SMA Sonitron Multi- Application	I Intermittent	- 13 17 21 24 30 Square diameter (mm)	L LV L: Loud LV: Low voltage	C T C: C-MOS T: Transistor	P7.5 P10 P15 P17.5 P20.32 S P: Pin distance (in mm) S: SMD terminals
---	------------------------------	--	---	---	--

LIST OF AVAILABLE PRODUCT TYPES

Version	Standard (°°)	Loud (L)	Transistor (LT)	Low Current (LC)	Intermittent (I) (*)	Low Voltage (LV)
SMA-13 series	SMA-13 P7.5 SMA-13 P10 SMA-13 S		SMA-13LT P7.5 SMA-13LT P10 SMA-13LT S	SMA-13LC P7.5 SMA-13LC P10 SMA-13LC S		
SMA-17 series	SMA-17 P7.5 SMA-17 P10 SMA-17 S	SMA-17L P7.5 SMA-17L P10 SMA-17L S	SMA-17LT P7.5 SMA-17LT P10 SMA-17LT S	SMA-17LC P7.5 SMA-17LC P10 SMA-17LC S		
SMA-21 series	SMA-21 P10 SMA-21 P15 SMA-21 P17.5 SMA-21 S	SMA-21L P10 SMA-21L P15 SMA-21L P17.5 SMA-21L S	SMA-21LT P10 SMA-21LT P15 SMA-21LT P17.5 SMA-21LT S	SMA-21LC P10 SMA-21LC P15 SMA-21LC P17.5 SMA-21LC S		SMA-21LV P10 SMA-21LV P15 SMA-21LV S
SMA-24 series	SMA-24 P10 SMA-24 P15 SMA-24 P17.5 SMA-24 P20.32 SMA-24 S	SMA-24L P10 SMA-24L P15 SMA-24L P17.5 SMA-24L P20.32 SMA-24L S			SMAI-24 P10 SMAI-24 P15 SMAI-24 P17.5 SMAI-24 P20.32 SMAI-24 S	
SMA-30 series	SMA-30 P15 SMA-30 P17.5 SMA-30 P20.32 SMA-30 S	SMA-30L P15 SMA-30L P17.5 SMA-30L P20.32 SMA-30L S				

* When the third pin of SMAI-24 is left open, the audible signal is intermittent. When the third pin is connected to the (-), the audible signal is continuous. When the third pin is connected to the (+), there is no sound (=stop).

Order options and packaging information see page 52, 53.



SMAT SERIES

The SMAT transducers are specifically developed to meet various requirements, such as loud sound pressure level, mounting methods, connection possibilities and dimensions. The transducers do not have a built-in oscillator. The drive frequency must be generated with electronics outside the transducer. Recommended drive circuits are described in this catalogue. Our transducers produce a highly reliable audible tone signal, giving either an extremely clear and penetrating tone or a soft sound for non-aggressive signals. They are available in five sizes: 13mm, 17mm, 21mm, 24mm and 30mm.

ADVANTAGES & APPLICATIONS

ADVANTAGES :

- Octagonal form
- Models with different pin pitches
- Light but solid construction
- Not fixed working frequency
- Easily mountable
- SMAT-13 and SMAT-17 for limited space applications
- SMD models with heat resistant labels for protection during re-flow soldering
- Automatic pick & place

APPLICATIONS :

- Alarms
- Gas & metal detectors
- Measuring & weighing equipment
- Medical instrumentation
- Timers & clocks
- Instrumentation & control systems
- Copiers
- Automobiles & trucks
- Games & toys
- Cash registers

SPECIFICATIONS

Model	SPL * (dB(A))	Frequency Range (Hz)	Capacitance (+/-30%) nF)	Operating voltage (VAC pp)	Weight (g)
SMAT-13	See graph	800-5000	7.8	0 to 30	1
SMAT-17	See graph	800-5000	17.5	0 to 30	2
SMAT-21	See graph	600-5000	12.4	0 to 30	2.5
SMAT-24	See graph	400-5000	18.6	0 to 30	4
SMAT-30	See graph	300-5000	25	0 to 30	5

Operating temperature	-20°C to +70°C
Storage temperature	-40°C to +85°C
Life time (@ 21°C)	@12Vpp continuous use at resonance frequency, tested on maximum sound pressure (eg. SMAT-21 @ 3.75 kHz). Life expectations: min.1000 hours. All tests are made @ 20°C mounted on PCB (expected life time curve in addendum).
Case material	ABS (UL rating: 94 HB) for pin-versions, SMAT-13/21/30 PBT (UL rating: 94 HB) for pin versions, SMAT-17/24 PPS (UL rating: 94 V0/5V) for SMD-versions, SMAT-13/17/21/24/30
Standard colour of case	Grey

* All measurements are made in free air @ 21°C @ 30 cm @10 Vpp (square wave). The test buzzer is soldered on a pcb board with dimensions of 24 cm x 11 cm.

ELECTRICAL PARAMETERS

<p>Model</p> <p>Sound pressure vs. frequency</p>	<p>SMAT-13</p> <p>dB (A)</p> <p>kHz</p>	<p>SMAT-17</p> <p>dB (A)</p> <p>kHz</p>
<p>Model</p> <p>Sound pressure vs. frequency</p>	<p>SMAT-21</p> <p>dB (A)</p> <p>kHz</p>	<p>SMAT-24</p> <p>dB (A)</p> <p>kHz</p>
<p>Model</p> <p>Sound pressure vs. frequency</p>	<p>SMAT-30</p> <p>dB (A)</p> <p>kHz</p>	<p>Peak hold frequency sweep from 1 to 8kHz with a square wave signal of 10Vpp. (precision of frequency: +/- 15%)</p>

All measurements are made @ 30 cm in free air @ 21°C.

DRIVE CIRCUITS (typical circuits)

IC Oscillation Circuit

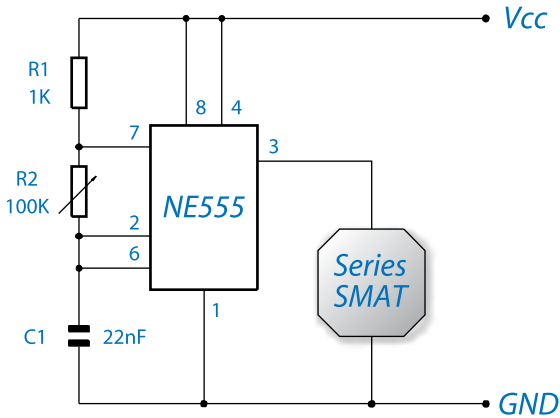

Multivibrator Circuit

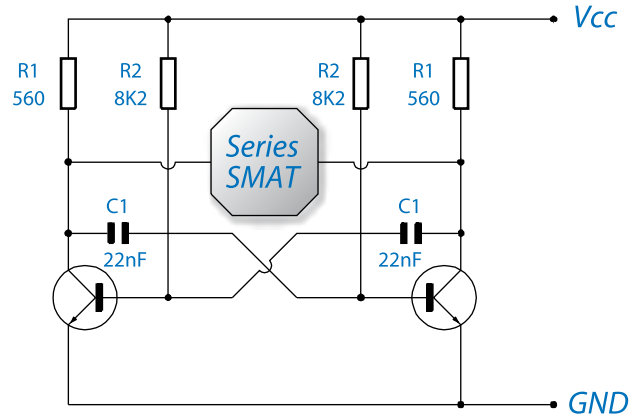

Inverter Oscillator

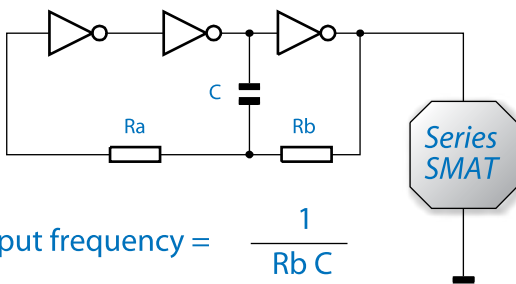

$$\text{Output frequency} = \frac{1}{R_b C}$$

Inverters are CMOS 4049 or 4069

Nandgate Oscillator

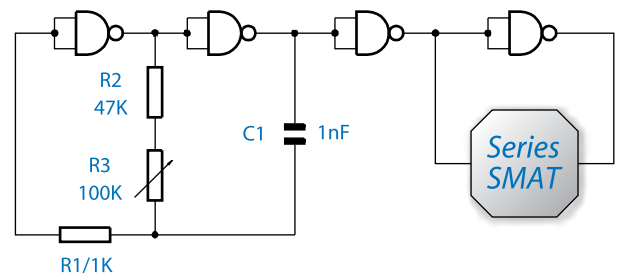

Nandgates are CMOS 4011A

5 Nandgate Oscillator - 3 tones

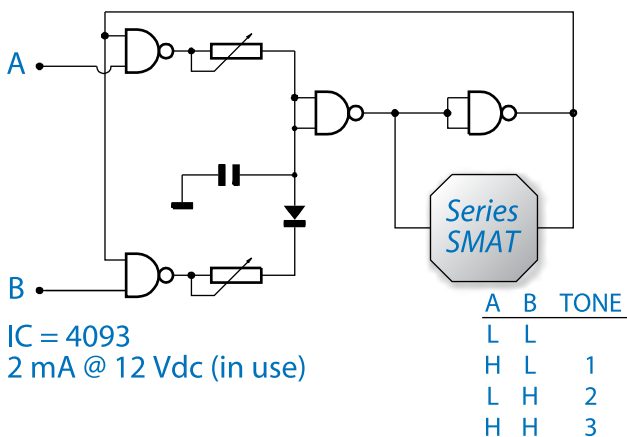

Tone Generator - CMOS - Gate Multifunction

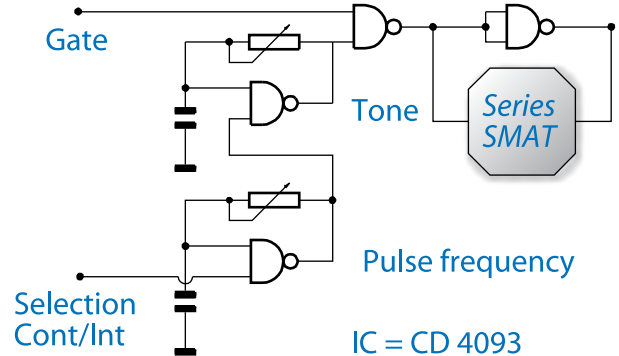

When the transducers are used in a drive circuit at one single frequency, the designer should bear in mind that the precision of the frequency, as mentioned on the graph "sound pressure vs. Frequency" is +/- 15%. We therefore recommend to test the sound pressure level with the transducer connected to the final drive circuit.

PRODUCT CODIFICATION



SMA ↓ Sonitron Multi- Application	T ↓ Transducer	13 17 21 24 30 ↓ Square diameter (mm)	P7.5 P10 P15 P17.5 P20.32 S ↓ P: Pin distance (in mm) S: SMD terminals
---	----------------------	---	--

LIST OF AVAILABLE PRODUCT TYPES

SMAT-13 P7.5 SMAT-13 P10 SMAT-13 S	SMAT-17 P7.5 SMAT-17 P10 SMAT-17 S	SMAT-21 P10 SMAT-21 P15 SMAT-21 P17.5 SMAT-21 S	SMAT-24 P10 SMAT-24 P15 SMAT-24 P17.5 SMAT-24 P20.32 SMAT-24 S	SMAT-30 P15 SMAT-30 P17.5 SMAT-30 P20.32 SMAT-30 S
--	--	--	--	---

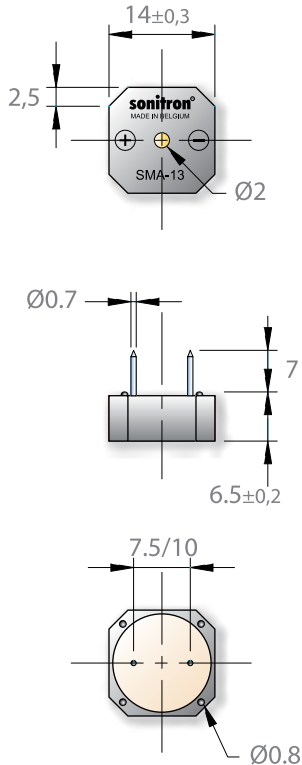
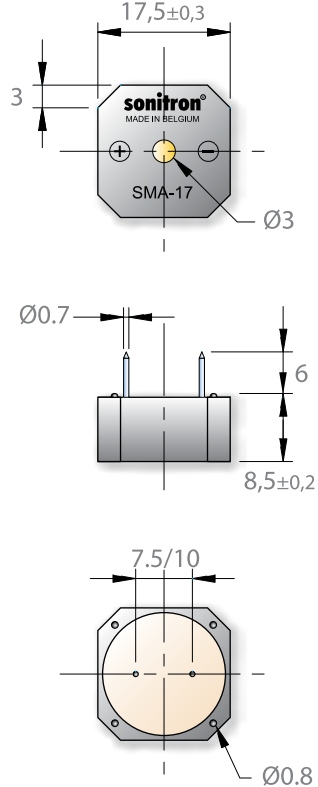
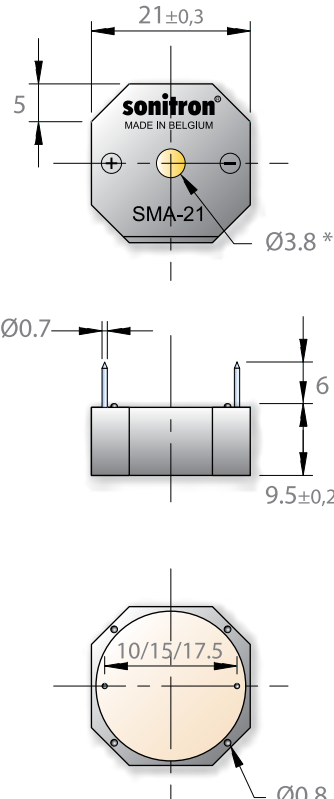

DIMENSIONS SMA & SMAT-SERIES (All dimensions are in mm)

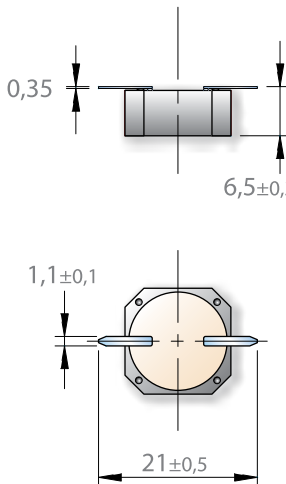
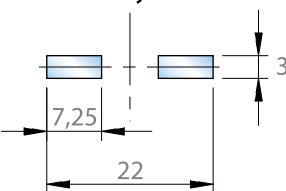
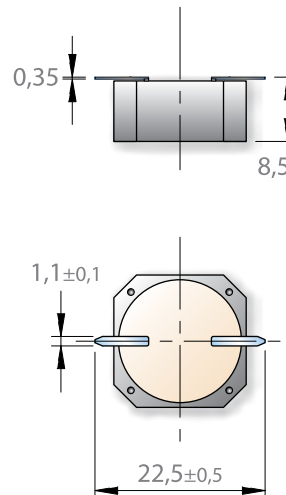
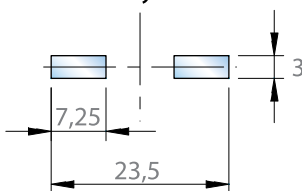
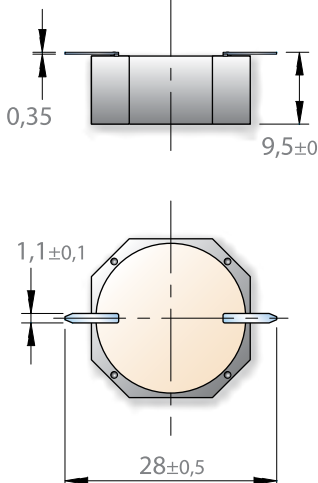
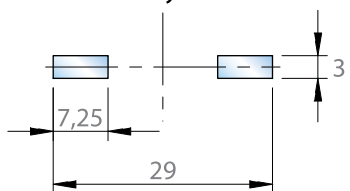
<p>Pin version</p> 	<p>SMA(T)-13</p> 	<p>SMA(T)-17</p> 	<p>SMA(T)-21</p> 
<p>SMD version</p> 	 <p>Recommended PCB lay-out</p> 	 <p>Recommended PCB lay-out</p> 	 <p>Recommended PCB lay-out</p> 

* The sound hole of SMA-21 LV has a diameter of 3 mm, whereas the other SMA-21 types have a 3,8 mm sound hole.

(All dimensions are in mm)

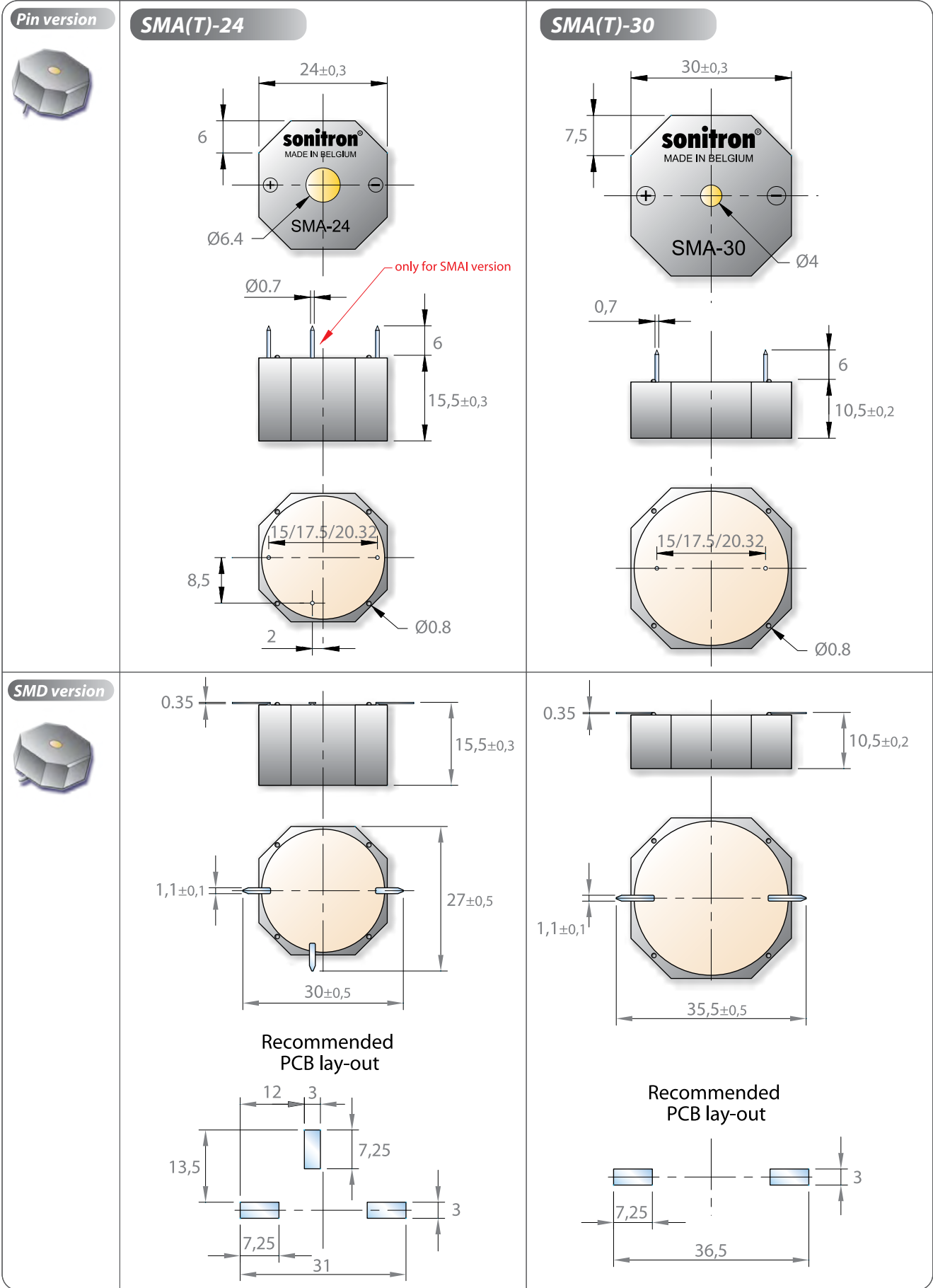

MOUNTING POSSIBILITIES FOR THE SMA & SMAT SERIES

Soldered with pins on the PCB

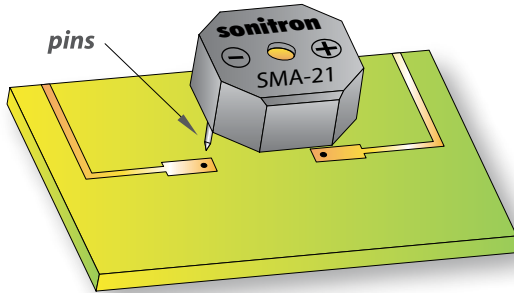

SMD soldered on the PCB

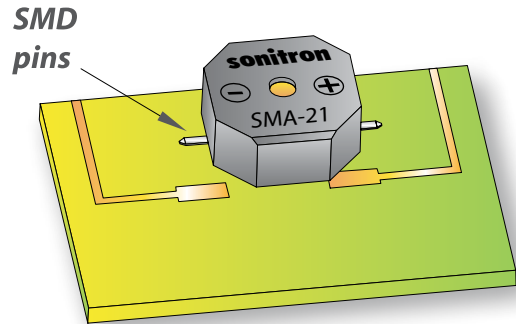

PRODUCT OPTIONS SMA & SMAT SERIES

Option Code	example	Description
SP01	SMAT-21-P10/SP01	Contains heavy duty wires (plastic insulation) <i>(only for SMA(T)-21 and SMA(T)-24)</i>
SP02	SMAT-21-P17.5/SP02	Contains heavy duty wires (plastic insulation), connection sealed with silicone <i>(only for SMA(T)-21, SMA(T)-24)</i>
SP04	SMA-13LC-S/SP04	The PCB of the buzzer/transducer is secured with epoxy-adhesive
SP05	SMA-24L-P17.5/SP05	Extended frequency control (only SMA series)
Wash Tab	SMAT-13-P7.5 +Wash Tab	Recommended for automatic washing production process. The PCB is secured with epoxy-adhesive+ wash tab upon the sound-emitting hole, avoiding liquid penetration into the cavity. TO BE REMOVED AFTER the washing process for good sound output!!!
MC	SMAT-13-P10-MC	Acryl coating (Membrane Coating). Recommended for aggressive, humid or smoggy environment.
FP13 FP13SR FP17 FP17SR FP21 FP24 FP30		7 different Foam Patches are available to cover the SMA(T) series for extra acoustic and mechanical stabilization. See page 38, 39



To order an option add the suffix to the model number of the SMA(T)-series.

Capton A heat protection label standard for all SMD buzzers, in capton material glued on the SMD model of the SMA(T) buzzer. This enables the user to pick up the buzzer by vacuum.
During the re-flow soldering process the heat shield label remains on the buzzer and must be removed after soldering.

PACKAGING SMA & SMAT-SERIES

All models with pin terminals are put on a polystyrene board (245 L x 245 W) and sold in boxes with dimensions 250 L x 250 W x 125 H.

Number	SMA(T)-13 series	SMA(T)-17 series	SMA(T)-21 series	SMA(T)-24 series	SMA(T)-30 series
per board	250	150	100	100	64
per box	(8x250) 2000	(6x150) 900	(5x100) 500	(5x100) 500	(6x64) 384

All SMD models are packed in trays (245 L x 245 W) and sold in boxes with dimensions 250 L x 250 W x 125 H.

Number	SMA(T)-13 S	SMA(T)-17 S	SMA(T)-21 S	SMA(T)-24 S	SMA(T)-30 S
per board	100	81	49	42	25
per box	(9x100) 900	(8x81) 648	(7x49) 343	(5x42) 210	(6x25) 150

Dimensions of the tray and position of the SMD components:

Model	A	B
SMA(T)-13-series	22 mm	16 mm
SMA(T)-17-series	24 mm	18 mm
SMA(T)-21-series	30 mm	16.7 mm
SMA(T)-24-series	35 mm	22.6 mm
SMA(T)-30-series	36 mm	19 mm

