

GENERAL CATALOGUE

Low Voltage Switch Gear



Advanced Industrial Automation



Note: Specifications subject to change without notice.
Cat. No. J510-E2-02A

OMRON





Low Voltage Switch Gear

Selection Guide		H-2
J7KNA-AR	Mini Contactor Relays 4-pole	H-7
J7KNA	Mini Motor Contactor	H-15
J7KN	Motor Contactor	H-27
J7TKN	Thermal Overload Relay	H-57
J7MN	Motor Protection Circuit Breaker (MPCB)	H-69
Appendix		H-83



Low Voltage Switch Gear





Classification	Mini Contactor Relays		Mini Motor Contactors	
Model	J7KNA - AR	J7KNA	J7KNA-4	
Appearance				
Remarks	AC and DC operated 4-, 6- and 8-contacts in different configurations Positively guided contacts Screw fixing and snap fitting (DIN rail)	AC and DC operated 3 main poles 1 auxiliary contact integrated (1NO or 1NC)	AC operated 4 main poles	
Accessoires	Auxiliar contact modules	Auxiliar contact modules Suppressors Link module MPCB - contactor	Auxiliar contact modules Suppressors Link module MPCB - contactor	
Maximum power (AC3-380/415V)	No	4 kW; 5,5 kW	4 kW	
Rated current (AC3-380/415V)	10 A (I th2)	9/12 A	9 A	
AC operated	Yes	Yes	Yes	
DC operated	Yes	Yes	No	
4 - pole version	Yes	No	Yes	
Auxiliary contacts included	No	1NO or 1NC	No	
Auxiliary contacts front mounting	1NO/1NC 0NO/2NC 2NO/2NC 4NO/0NC	1NO/1NC 0NO/2NC 2NO/2NC	1NO/1NC 0NO/2NC 2NO/2NC	
Auxiliary contacts side mounting	No	No	No	
Mechanical life span (AC operated)	5 Mio.	5 Mio.	5 Mio.	
Mechanical life span (DC operated)	15 Mio.	15 Mio.	15 Mio.	
Setting range (in A)	No	No	No	
Page No.	H-7	H-15	H-15	

Motor Contactors



J7KN 10..KN 22	J7KN 24..KN 40	J7KN 50..KN 74	J7KN 85..KN 110
3-pole	3-pole	3-pole	3-pole
			
AC and DC operate 3 main poles 1 auxiliary contact integrated (1NO or 1NC) max 4 auxiliary contacts front mounted	AC and DC operate 3 main poles max 4 auxiliary contacts front mounted 2 auxiliary contacts side mounted (1NO or 1NC)	AC and DC operate 3 main poles max 4 auxiliary contacts front mounted 2 auxiliary contacts side mounted (1NO or 1NC)	AC and DC operate 3 main poles 4 auxiliary contacts integrated (1NO/1NC)
Auxiliar contact modules Mechanical interlock Suppressors Link module MPCB-contactor Pneumatic timers	Auxiliar contact modules Mechanical interlock Suppressors Link module MPCB-contactor Pneumatic timers	Auxiliar contact modules Mechanical interlock Suppressors Pneumatic timers	Mechanical interlock Suppressors
4 kW; 5,5 kW; 7,5 kW; 11 kW	11 kW; 15 kW; 18,5 kW	22 kW; 30kW; 37 kW	45 kW; 55 kW
10/14/18/22 A	24/32/40 A	50/62/74 A	85/110 A
Yes	Yes	Yes	Yes
Yes	Yes	Yes	Yes
No	No	No	No
1NO or 1NC	No	No	2NO + 2NC
max 4 NO/NC	max 4 NO/NC	max 4 NO/NC	No
No	1NO + 1NC	1NO + 1NC	1NO + 1NC
10 Mio.	10 Mio.	10 Mio.	5 Mio.
10 Mio.	10 Mio.	10 Mio.	5 Mio.
No	No	No	No
H-27	H-27	H-27	H-27

Low Voltage Switch Gear

Classification	Motor Contactors		Thermal Overload Relays
Model	J7KN 150..KN 175	J7KN 200	J7TKN-A
Appearance	3-pole 	3-pole 	
Remarks	AC and DC operate 3 main poles 2 auxiliary contacts integrated (1NO/ 1NC)	AC and DC operate 3 main poles 4 auxiliary contacts integrated (1NO/ 1NC)	Direct mounting 1 auxiliary contact (change over)
Accessoires	No	No	No
Maximum power (AC3-380/415V)	75 kW; 90 kW	110 kW	
Rated current (AC3-380/415V)	150/175 A	210 A	
AC operated	Yes	Yes	
DC operated	No	No	
4 - pole version	No	No	
Auxiliary contacts included	1NO + 1NC	2NO + 2NC	1NO + 1NC
Auxiliary contacts front mounting	No	No	
Auxiliary contacts side mounting	1NO + 1NC	2NO + 2NC	
Mechanical life span (AC operated)	10 Mio.	10 Mio.	
Mechanical life span (DC operated)	10 Mio.	10 Mio.	
Setting range (in A)	No	No	0,12..30 A
Page No.	H-27	H-27	H-57

Thermal Overload Relays		Motor Protection Circuit Breakers (MPCB)	
J7TKN-B..TKN-D	J7TKN-E..TKN-F	J7MN12	J7MN25
			
Direct mounting Auto, -manual, -reset button 2 auxiliary contacts (1NO/1NC)	Separate mounting 2 auxiliary contacts (1NO/1NC)	Rocker operating switch Short circuit release Over load release I _{cu} = 100 kA (0,16..6,3 A)	Rotary operating switch Short circuit release Over load release I _{cu} = 100 kA (0,16..12,5 A)
Sets for single mounting Busbar sets	Sets for single mounting Busbar sets	Trip indicating contact Plastic enclosures 2 contacts side mounted 2 contacts front mounted Bus bar system	Trip indicating contact Plastic enclosures 3 contacts side mounted 2 contacts front mounted Bus bar system
1NO + 1NC	1NO + 1NC	1NO + 1NC	1NO + 1NC
		1NO + 1NC	1NO + 1NC
		100000	100000
0,12..74 A	60..220 A	0,11..12 A	0,11..25 A
H-57	H-57	H-69	H-69

Low Voltage Switch Gear

Classification	Motor Protection Circuit Breakers (MPCB)	
Model	J7MN50	J7MN100
Appearance		
Remarks	Rotary operating switch Short circuit release Over load release I _{cu} = 50 kA	Rotary operating switch Short circuit release Over load release I _{cu} = 50 kA
Accessoires	Trip indicating contact Plastic enclosures 2 contacts side mounted 3 contacts front mounted Bus bar system	Trip indicating contact Plastic enclosures 2 contacts side mounted 3 contacts front mounted Bus bar system
Maximum power (AC3-380/415V)		
Rated current (AC3-380/415V)		
AC operated		
DC operated		
4 - pole version		
Auxiliary contacts included		
Auxiliary contacts front mounting	1NO + 1NC	1NO + 1NC
Auxiliary contacts side mounting	1NO + 1NC	1NO + 1NC
Mechanical life span (AC operated)	50000	50000
Mechanical life span (DC operated)		
Setting range (in A)	22..50 A	45..100 A
Page No.	H-69	H-69

Mini Contactor Relays 4-pole J7KNA-AR

Main contactor

- AC & DC operated
- 4-, 6- and 8-pole versions in different configurations
- Positively guided contacts
- Screw fixing and snap fitting (35 mm DIN rail)
- Rated current = 10A (I_{th})
- Suitable for electronic devices (DIN 19240)
- Finger proof (VBG 4)

Accessories

- 2- and 4-pole additional auxiliary contacts in different configurations



Approved Standards

Standard	Guide No (US,C)
UL	NKCR, NKCR7
ICE 947-5-1	
VDE 0660	
EN 60947-5-1	

Ordering Information

■ Model Number Legend

1. Mini Contactor Relays

J7KNA-□□-□□-□□□□

1 2 3 4

- 1) Mini Contactor
- 2) AR: Contactor Relay
- 3) Combination of NO / NC contacts
 - 22: 2 NO 2 NC
 - 31: 3 NO 1 NC
 - 40: 4 NO 0 NC
- 4) Coil voltage (AC operated)
 - 24: AC24V 50/60Hz
 - 48: AC48V 50Hz
 - 110: AC110-115V 50Hz, AC120-125V 60Hz
 - 230: AC220-230V 50Hz, AC240V 60Hz
 - 240: AC230V-240V 50Hz
 - 400: AC380-400V 50Hz, AC440V 60Hz
 - 415: AC400-415V 50Hz
 - 550: AC525-550V 50Hz, AC600V 60Hz

- Coil voltage (DC operated)
- 24D: DC24V
 - 48D: DC48V
 - 60D: DC60V
 - 110D: DC110V
 - 125D: DC125V
 - 24VS: DC24V with diode
 - 48VS: DC48V with diode
 - 110VS: DC110V with diode

2. Aux. Contact Modules for Mini Contactor Relays

J73KN-□□-□□-□

1 2 3 4

- 1) Auxiliary Contact Modules
- 2) A: for mini contactor relay
- 3) Combination of NO/NC contacts
 - 11: 1 NO 1 NC
 - 02: 0 NO 2 NC
 - 22: 2 NO 2 NC
 - 40: 4 NO 0 NC

■ System overview

Mini Contactor Relays 4-pole

AC Operated

	Contacts		Distinc. Number acc. to DIN EN 50011	Ratings		Thermal Rated Current I_{th} A	Type	Pack	Weight
	NO	NC		AC15 230V A	400V A				
	4-pole, With Screw Terminals								
	4	-	40E	3	2	10	J7KNA-AR-40 24	10	0,16
							J7KNA-AR-40 230		
	3	1	31E	3	2	10	J7KNA-AR-31 24	10	0,16
							J7KNA-AR-31 230		
	2	2	22E	3	2	10	J7KNA-AR-22 24	10	0,16
							J7KNA-AR-22 230		

1) Other coil voltages see page 10

DC Solenoid Operated

	Contacts		Distinc. Number acc. to DIN EN 50011	Ratings		Thermal Rated Current I_{th} A	Type	Pack	Weight
	NO	NC		AC15 230V A	400V A				
	4-pole, With Screw Terminals								
	4	-	40E	3	2	10	J7KNA-AR-40 24D (-VS) ¹⁾	10	0,19
	3	1	31E	3	2	10	J7KNA-AR-31 24D (-VS) ¹⁾	10	0,19
	2	2	22E	3	2	10	J7KNA-AR-22 24D (-VS) ¹⁾	10	0,19

1) VS = with diode

Auxiliary Contact Blocks for Contactor Relays J7KNA-AR

	Contacts		Ratings	Thermal Rated Current I_{th} A	Type	Pack	Weight	
	NO	NC						AC15 230V A
	1	1	3	2	10	J73KN-A-11	10	0,04
	-	2	3	2	10	J73KN-A-02	10	0,04
	4	-	3	2	10	J73KN-A-40	10	0,04
	2	2	3	2	10	J73KN-A-22	10	0,04

■ System overview

Mini Contactor Relays 4-pole

AC Operated

Wiring Diagrams	Distinc. Number acc. to DIN EN 50011	Auxiliary Contact Blocks	Contactor Relay with Auxiliary Contact			Contacts suitable for Electronic Circuits according to DIN 19240 for rated voltage 24V DC (test ratings 17V DC, 5mA) Positively guided contacts	
		Type	NO	NC	Block Distinc. Number according to DIN EN 50011	NO NC	
4-pole, With Screw Terminals							
	40E	J73KN-A-11	1	1	51E	5 1	Preferable combinations with distinctive letter „E“ according to DIN EN 50011
		J73KN-A-02	0	2	42E	4 2	
		J73KN-A-40	4	0	80E	8 0	
		J73KN-A-22	2	2	62E	6 2	
	31E	J73KN-A-11	1	1	42Y	4 2	
		J73KN-A-02	0	2	33Y	3 3	
		J73KN-A-40	4	0	71Y	7 1	
		J73KN-A-22	2	2	53Y	5 3	
	22E	J73KN-A-11	1	1	33Y	3 3	
		J73KN-A-02	0	2	24Y	2 4	
		J73KN-A-40	4	0	62Y	6 2	
		J73KN-A-22	2	2	44Y	4 4	

DC Solenoid Operated

Wiring Diagrams	Distinc. Number acc. to DIN EN 50011	Auxiliary Contact Blocks	Contactor Relay with Auxiliary Contact				
		Type	NO	NC	Block Distinc. Number according to DIN EN 50011	NO NC	
4-pole, With Screw Terminals							
	40E	J73KN-A-11	1	1	51E	5 1	Preferable combinations with distinctive letter „E“ according to DIN EN 50011
		J73KN-A-02	0	2	42E	4 2	
		J73KN-A-40	4	0	80E	8 0	
		J73KN-A-22	2	2	62E	6 2	
	31E	J73KN-A-11	1	1	42Y	4 2	
		J73KN-A-02	0	2	33Y	3 3	
		J73KN-A-40	4	0	71Y	7 1	
		J73KN-A-22	2	2	53Y	5 3	
	22E	J73KN-A-11	1	1	33Y	3 3	
		J73KN-A-02	0	2	24Y	2 4	
		J73KN-A-40	4	0	62Y	6 2	
		J73KN-A-22	2	2	44Y	4 4	

Auxiliary Contact Blocks for Contactor Relays J7KNA-AR

Wiring diagrams				Contacts suitable for Electronic Circuits according to DIN 19240 for rated voltage 24V DC (test ratings 17V DC, 5mA) Positively guided contacts
J73KN-A-11	J73KN-A-02	J73KN-A-40	J73KN-A-22	

Specifications

■ Coil Voltages

Suffix to contactor type e.g. J7KNA-09-10-24	Voltage Marking at the coil		Rated Control Voltage U _s range for			
	for 50Hz V	for 60Hz V	50Hz		60Hz	
			min V.	max V.	min V.	max V.
12	12	12	11	12	12	12
24	24	24	22	24	24	24
42	42	42	38.5	42	42	42
48	48-50	48	48	50	48	50
60	60	60	52	66	54	60
90	90-95	100-105	90	95	100	105
95	95-100	105-110	95	100	105	110
100	100	110-115	100	105	110	115
105	105-110	115-120	105	110	115	120
110	110-115	120-125	110	115	120	125
200	200	210-220	195	205	210	220

Suffix to contactor type e.g. J7KNA-09-10- 230	Voltage Marking at the coil		Rated Control Voltage U _s range for			
	for 50Hz V	for 60Hz V	50Hz		60Hz	
			min V.	max V.	min V.	max V.
210	205-215	220-230	205	215	220	230
220	210-220	230-240	210	220	230	240
230	220-230	240	220	230	240	250
240	230-240		230	240	250	260
400	380-400	440	380	400	415	440
500	475-500	520-545	475	500	520	545
550	525-550	600	525	550	570	600

Standard voltages in bold type letters. Coil not exchangeable

Engineering data and Characteristics

Mini Contactor Relays

Data according to IEC 947-5-1, VDE 0660, EN 60947-5-1

Auxiliary Contacts		Type	J7KNA-AR...	J7KNA-AR...D	J7KNA-AR...VS	J73KN-A...
Rated insulation voltage U_i		V AC	690 ^{*1}	690 ^{*1}	690 ^{*1}	690 ^{*1}
Thermal rated current I_{th} to 690V						
Ambient temperature		40°C	A 10	10	10	10
		60°C	A 6	6	6	6
Power loss per pole		at I_{th}	W 0.5	0.5	0.5	0.5
Utilization category AC15						
Rated operational current I_e		220-240V	A 3	3	3	3
		380-415V	A 2	2	2	2
		440V	A 1.6	1.6	1.6	1.6
		500V	A 1.2	1.2	1.2	1.2
		660-690V	A 0.6	0.6	0.6	0.6
Utilization category DC13						
Rated operational current I_e		60V	A 2	2	2	2
		110V	A 0.4	0.4	0.4	0.4
		220V	A 0.1	0.1	0.1	0.1
Maximum ambient temperature						
Operation		open	°C	-40 to +60 (+90) ^{*2}		
		enclosed	°C			
Storage			°C	-40 to +40		
				-40 to +90		
Short circuit protection						
short-circuit current 1kA, contact welding not accepted						
max. fuse size		gL (gG)	A 20	20	20	20
Power consumption of coils						
AC operated		inrush	VA 25	-	-	-
		sealed	VA 4 - 5	-	-	-
			W 1.2	-	-	-
DC operated		inrush	W -	2.5	2.5	-
		sealed	W -	2.5	2.5	-
Operation range of coils						
in multiples of control voltage U_s			0.85 - 1.1	0.8 - 1.1	0.8 - 1.1	-
Switching time at control voltage $U_s \pm 10\%$^{*3,*4}						
AC operated		make time	ms 15 - 25	-	-	-
		release time	ms 8 - 25	-	-	-
		arc duration	ms 10 - 15	-	-	-
DC operated		make time	ms -	15 - 19	-	-
		release time	ms -	8 - 25	-	-
		arc duration	ms -	10 - 15	-	-

Mini Contactor Relays

Data according to IEC 947-5-1, VDE 0660, EN 60947-5-1

Auxiliary Contacts		Type	J7KNA-AR...	J7KNA-AR...D	J7KNA-AR...VS	J73KN-A...
Cable cross-section						
all connectors	solid	mm ²	0.75 - 2.5	0.75 - 2.5	0.75 - 2.5	0.75 - 2.5
	flexible	mm ²	0.75 - 2.5	0.75 - 2.5	0.75 - 2.5	0.75 - 2.5
	flexible with multicore cable end	mm ²	0.5 - 1.5	0.5 - 1.5	0.5 - 1.5	0.5 - 2.5
Clamps per pole			2	2	2	2
	solid or stranded	AWG	18 - 14	18 - 14	18 - 14	18 - 14

*1) Suitable at 690V for: earthed-neutral systems, overvoltage category I to IV, pollution degree 3 (standard-industry): $U_{imp} = 8kV$.
Data for other conditions on request.

*2) With reduced control voltage range 0.9 up to $1.0 \times U_s$ and with reduced thermal rated current I_{th} to $I_g/AC15$

*3) Summary switching time = release time + arc duration

*4) Release time of NC make time of NO increase when suppressor units for voltage peak protection are used (Varistor, RC-units, Diode units).

Mini Contactor Relays for North America

Data according to UL508

Main Contacts (cULus)		Type	J7KNA-AR...	J73KN-A...
Rated operational current "General Use"		A	10	10
Rated operational power of three-phase motors at 60Hz (3ph)	115V	hp	-	-
	200V	hp	-	-
	230V	hp	-	-
	460V	hp	-	-
	575V	hp	-	-
Rated operational power of of AC motors at 60Hz (1ph)	115V	hp	-	-
	200V	hp	-	-
	230V	hp	-	-
Fuses		A	-	-
Suitable for use on a capability of delivering not more than rms		A	-	-
		V	-	-
Rated voltage		V AC	600	600
Auxiliary Contacts (cULus)				
	heavy pilot duty	AC	A600	A600
	standard pilot duty	DC	Q600	Q600

■ Dimensions

AC and DC operated
with screw terminals

Auxiliary Contact Blocks

J7KNA-AR...

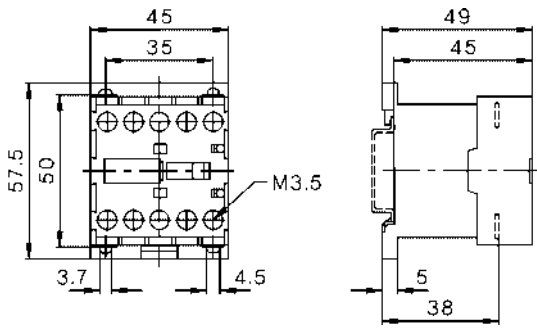

J73KN-A...

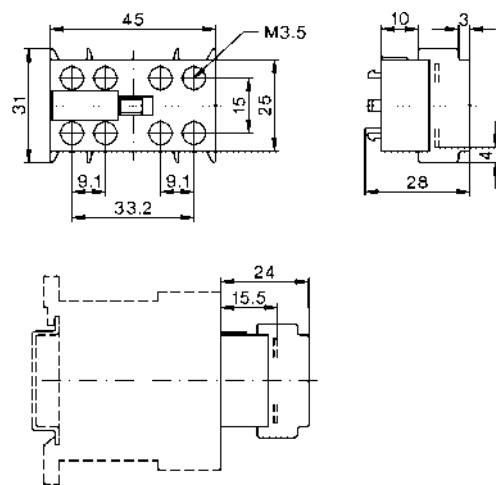

ALL DIMENSIONS SHOWN ARE IN MILLIMETERS.

Cat. No. J507-E2-02

In the interest of product improvement, specifications are subject to change without notice.

Mini Motor Contactor J7KNA

Main contactor

- AC & DC operated
- Integrated auxiliary contacts
- Screw fixing and snap fitting (35 mm DIN rail)
- Range from 4 to 5.5 kW (AC 3, 380/415V)
- 4 -main pole version (4 kW AC and DC coil)
- Auxiliary contacts suitable for electronic devices (DIN 19240)
- Finger proof (VBG 4)



Accessories

- 2 and 4 pole additional auxiliary contacts in different configurations
- Mechanical interlock (in reversing contactor combination only)
- RC Suppressors

Approved Standards

Standard	Guide No (US,C)
UL	NLDX, NLDX7
ICE 947-5-1	
VDE 0660	
EN 60947-5-1	

Ordering Information

Model Number Legend

1. Mini Motor Contactors

J7KNA-□□-□□-□□□□□□

1 2 3 4 5

- 1) Mini Contactor
- 2) Rated Motor Current (AC3 400V)
09: 9A
12: 12A
- 3) Integrated auxiliary contact
10: 1 NO 0 NC
01: 0 NO 1 NC
4: 4 main pole type (no aux contact)
- 4) W: Reversing Contactor
- 5) Coil voltage (AC operated)¹⁾
24: AC24V 50/60Hz
48: AC48V 50Hz
60: AC60V 50Hz
110: AC110-115V 50Hz, AC120-125V 60Hz
230: AC220-230V 50Hz, AC240V 60Hz
240: AC230V-240V 50Hz

¹⁾ RC-suppressor unit go to page H-29, section 6 or page H-35, suppressor units

- 400: AC380-400V 50Hz, AC440V 60Hz
- 415: AC400-415V 50Hz

- Coil voltage (DC operated)
- 24D: DC24V
 - 48D: DC48V
 - 60D: DC60V
 - 110D: DC110V
 - 24VS: DC24V with diode
 - 48VS: DC48V with diode
 - 110VS: DC110V with diode

2. Aux. Contact Modules for Mini Motor Contactors

J73KN-□□-□□-□□



1 2 3 4

- 1) Auxiliary Contact Modules
- 2) AM: for mini motor contactor
- 3) Combination of NO/NC contacts
11: 1 NO 1 NC
02: 0 NO 2 NC
22: 2 NO 2 NC
40: 4 NO 0 NC
- 4) for Reversing Contactors
v: left side
x: right side

■ System overview



Mini Motor Contactors

AC Operated

	Ratings			Rated Current		Aux. Contacts		Type	Pack	Weight	
	AC2, AC3			AC3	AC1						
	380V 400V 415V kW	500V kW	660V 690V kW	400V A	690V A			Accept Overload Relay see page H-58	24 230	Coil Voltage ^{*1} 24V 50/60Hz 220-230V 50Hz	pcs. kg/pc.
	3-pole, With Screw Terminals										
	4	4	4	9	20	1	-	J7TKN-A	J7KNA-09-10-□□□□□	10	0.16
	5.5	5.5	5.5	12	20	1	-	J7TKN-A	J7KNA-12-10-□□□□□	10	0.16
	4	4	4	9	20	-	1	J7TKN-A	J7KNA-09-01-□□□□□	10	0.16
	5.5	5.5	5.5	12	20	-	1	J7TKN-A	J7KNA-12-01-□□□□□	10	0.16
	4-pole, With Screw Terminals										
	4	4	4	9	20	-	-	J7TKN-A	J7KNA-09-4-□□□□□	10	0.19

*1) Other coil voltages see page H-20



DC Solenoid Operated

	Ratings			Rated Current		Aux. Contacts		Type	Pack	Weight	
	AC2, AC3			AC3	AC1						
	380V 400V 415V kW	500V kW	660V 690V kW	400V A	690V A			Accept Overload Relay see page H-58	24D 24VS ^{*1}	DC Coil Voltage 24V DC 2,5 W 24V DC 2,5 W w. diode ^{*2}	pcs. kg/pc.
	3-pole, With Screw Terminals										
	4	4	4	9	20	1	-	J7TKN-A	J7KNA-09-10-□□□□D(-VS)	10	0.19
	5.5	5.5	5.5	12	20	1	-	J7TKN-A	J7KNA-12-10-□□□□D(-VS)	10	0.19
	4	4	4	9	20	-	1	J7TKN-A	J7KNA-09-01-□□□□D(-VS)	10	0.19
	5.5	5.5	5.5	12	20	-	1	J7TKN-A	J7KNA-12-01-□□□□D(-VS)	10	0.19

*1) with built-in coil suppressor (varistor)

*2) with built-in coil suppressor (zener diode)

Auxiliary contact blocks with screw terminals for contactors J7KNA-09... and J7KNA-12...

	Contacts		Rated Current		Thermal Rated Current	Type	Pack	Weight
			AC15 230V A	400V A				
	1	1	3	2	10	J73KN-AM-11	10	0.04
	-	2	3	2	10	J73KN-AM-02	10	0.04
	2	2	3	2	10	J73KN-AM-22	10	0.04

System overview

Mini Motor Contactors

AC Operated

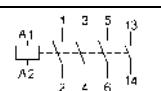
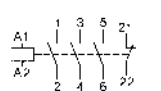
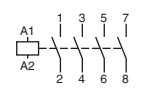
Wiring Diagrams	Distinc. Number according to DIN EN 50012	Auxiliary Contact Blocks			Contactor with Auxiliary Contact Block			Contacts suitable for Electronic Circuits according to DIN 19240 for rated voltage 24V DC (test ratings 17V DC, 5mA) Positively guided contacts
		Type	NO	NC	Distinc. Number according to DIN EN 50012	NO	NC	
3-pole, With Screw Terminals								
	10	J73KN-AM-11	1	1	21	2	1	Preferred combinations according to DIN EN 50012
		J73KN-AM-02	0	2	12	1	2	
		J73KN-AM-22	2	2	32	3	2	
	01	J73KN-A-11	1	1	-	1	2	Contacts according to DIN EN 50005
		J73KN-A-02	0	2	-	0	3	
		J73KN-A-40	4	0	-	4	1	
		J73KN-A-22	2	2	-	2	3	
4-pole, With Screw Terminals								
	00	J73KN-A-11	1	1	-	1	1	Contacts according to DIN EN 50005
		J73KN-A-02	0	2	-	0	2	
		J73KN-A-40	4	0	-	4	0	
		J73KN-A-22	2	2	-	2	2	

DC Solenoid Operated

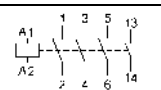
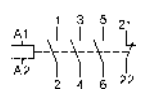
Wiring Diagrams	Distinc. Number according to DIN EN 50012	Auxiliary Contact Blocks			Contactor with Auxiliary Contact Block			Contacts suitable for Electronic Circuits according to DIN 19240 for rated voltage 24V DC (test ratings 17V DC, 5mA) Positively guided contacts
		Type	NO	NC	Distinc. Number according to DIN EN 50012	NO	NC	
3-pole, With Screw Terminals								
	10	J73KN-AM-11	1	1	21	2	1	Preferred combinations according to DIN EN 50012
		J73KN-AM-02	0	2	12	1	2	
		J73KN-AM-22	2	2	32	3	2	
	01	J73KN-A-11	1	1	-	1	2	Contacts according to DIN EN 50005
		J73KN-A-02	0	2	-	0	3	
		J73KN-A-40	4	0	-	4	1	
		J73KN-A-22	2	2	-	2	3	

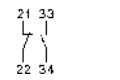
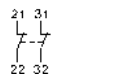
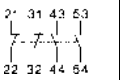
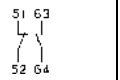
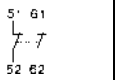
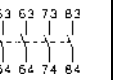
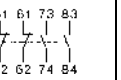

Auxiliary contact blocks with screw terminals for contactors J7KNA-09... and J7KNA-12...

Wiring Diagrams							Contacts suitable for Electronic Circuits according to DIN 19240 for rated voltage 24V DC (test ratings 17V DC, 5mA) Positively guided contacts
J73KN-AM-11	J73KN-AM-02	J73KN-AM-22	J73KN-A-11	J73KN-A-02	J73KN-A-40	J73KN-A-22	
							

LVSG



■ System overview

Mini Reversing Contactors, Mechanical Interlocked AC Operated

	Ratings			Rated Current		Aux. Contacts		Type	Pack	Weight	
	AC2, AC3			AC3	AC1						
	380V		660V					Accept Overload Relay see page H-58	24	kg/pc.	
	400V	500V	690V	400V	690V						Coil Voltage ^{*1}
	415V	kW	kW	A	A	NO	NC		230	kg/pc.	
	3-pole, With Screw Terminals										
	4	4	4	9	20	-	1	J7TKN-A	J7KNA-09-01-W-□□□□	1	0.32
	5.5	5.5	5.5	12	20	-	1	J7TKN-A	J7KNA-12-01-W-□□□□	1	0.32

*1) Other coil voltages see page H-20



DC Solenoid Operated

	Ratings			Rated Current		Aux. Contacts		Type	Pack	Weight	
	AC2, AC3			AC3	AC1						
	380V		660V					Accept Overload Relay see page H-58	24D	kg/pc.	
	400V	500V	690V	400V	690V						DC Coil Voltage
	415V	kW	kW	A	A	NO	NC		24VS ^{*1}	kg/pc.	
	3-pole, With Screw Terminals										
	4	4	4	9	20	-	1	J7TKN-A	J7KNA-09-01-W-□□□D	1	0.38
	5.5	5.5	5.5	12	20	-	1	J7TKN-A	J7KNA-12-01-W-□□□D	1	0.38

*1) with built-in coil suppressor (varistor)

*2) with built-in coil suppressor (zener diode)





Auxiliary contact blocks with screw terminals for contactors J7KNA-09-01-W...(D) and J7KNA-12-01-W...(D)

	Contacts		Rated Current		Thermal Rated Current	Type	Pack	Weight
			AC15	AC1				
	NO	NC	230V	400V	A		pcs.	kg/pc.
	1	1	A	A				
	1	1	3	2	10	J73KN-AM-11V	10	0.04
	1	1	3	2	10	J73KN-AM-11X	10	0.04



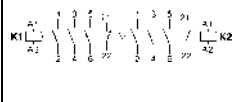

■ System overview

Mini Motor Contactors

AC Operated

Wiring Diagrams	Distinc. Number according to DIN EN 50012	Auxiliary Contact Blocks suitable for						Contacts suitable for Electronic Circuits according to DIN 19240 for rated voltage 24V DC (test ratings 17V DC, 5mA) Positively guided contacts
		left hand side Contactor K1 Type			right hand side Contactor K2 Type			
3-pole, With Screw Terminals								
	01	J73KN-AM-11V	1	1	J73KN-AM-11X	1	1	

DC Solenoid Operated

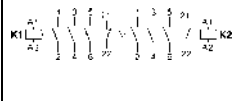
Wiring Diagrams	Distinc. Number according to DIN EN 50012	Auxiliary Contact Blocks suitable for						Contacts suitable for Electronic Circuits according to DIN 19240 for rated voltage 24V DC (test ratings 17V DC, 5mA) Positively guided contacts
		left hand side Contactor K1 Type			right hand side Contactor K2 Type			
3-pole, With Screw Terminals								
	01	J73KN-AM-11V	1	1	J73KN-AM-11X	1	1	

Auxiliary contact blocks with screw terminals for contactors J7KNA-09-01-W...(D) and J7KNA-12-01-W...(D)

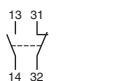
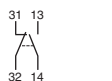
Wiring Diagrams						Contacts suitable for Electronic Circuits according to DIN 19240 for rated voltage 24V DC (test ratings 17V DC, 5mA) Positively guided contacts
J73KN-AM-11V	J73KN-AM-11X					
						

LVSG

Specifications

■ Coil Voltages

Suffix to contactor type e.g. J7KNA-09-10-24	Voltage Marking at the coil		Rated Control Voltage U _s range for			
	for 50Hz V	for 60Hz V	50Hz		60Hz	
			min V.	max V.	min V.	max V.
12	12	12	11	12	12	12
24	24	24	22	24	24	24
48	48-50	48	48	50	48	50
60	60	60	52	66	54	60
90	90-95	100-105	90	95	100	105
95	95-100	105-110	95	100	105	110
100	100	110-115	100	105	110	115
105	105-110	115-120	105	110	115	120
110	110-115	120-125	110	115	120	125
200	200	210-220	195	205	210	220

Suffix to contactor type e.g. J7KNA-09-10-230	Voltage Marking at the coil		Rated Control Voltage U _s range for			
	for 50Hz V	for 60Hz V	50Hz		60Hz	
			min V.	max V.	min V.	max V.
210	205-215	220-230	205	215	220	230
220	210-220	230-240	210	220	230	240
230	220-230	240	220	230	240	250
240	230-240		230	240	250	260
400	380-400	440	380	400	415	440
500	475-500	520-545	475	500	520	545
550	525-550	600	525	550	570	600

Standard voltages in bold type letters. Coil not exchangeable

Engineering data and Characteristics

Mini Motor Contactors

Data according to IEC 947-4-1, VDE 0660, EN 60947-4-1

Main Contacts	Type	J7KNA-09-...	J7KNA-12-...
Rated insulation voltage U_i	V AC	690 ¹⁾	690 ¹⁾
Making capacity I_{eff} at $U_e = 690V$ AC	A	165	165
Breaking capacity I_{eff} $\cos\varphi = 0,65$	400V AC	A 100	100
	500V AC	A 90	90
	690V AC	A 80	80
Utilization category AC1			
Switching of resistive load			
Rated operational current $I_e (=I_{th})$ at 40°C, open	A	20	20
Rated operational power of three-phase resistive loads 230V 50-60Hz, $\cos\varphi = 1$	230V	kW 7.9	7.9
	240V	kW 8.3	8.3
	400V	kW 13.8	13.8
	415V	kW 14.3	14.3
Rated operational current $I_e (=I_{th})$ at 60°C, enclosed	A	16	16
Rated operational power of three-phase resistive loads 230V 50-60Hz, $\cos\varphi = 1$	230V	kW 6.3	6.3
	240V	kW 6.7	6.7
	400V	kW 11	11
	415V	kW 11.5	11.5
Minimum cross-section of conductor at load with $I_e (=I_{th})$	mm ²	2.5	2.5
Utilization category AC2 and AC3			
Switching of three-phase motors			
Rated operational current I_e open and enclosed	220V	A 12	15
	230V	A 11.5	14.5
	240V	A 11	14
	380-400V	A 9	12
	415-440V	A 8	11
	500V	A 7	9
	660-690V	A 5	6.5
Rated operational power of three-phase motors 50-60Hz	220-240V	kW 3	4
	380-440V	kW 4	5.5
	500-690V	kW 4	5.5
Utilization category AC4			
Switching of squirrel cage motors, inching			
Rated operational current I_e open and enclosed	220V	A 12	15
	230V	A 11.5	14.5
	240V	A 11	14
	380-400V	A 9	12
	415-440V	A 8	11
	500V	A 7	9
	660-690V	A 5	6.5
Rated operational power of three-phase motors 50-60Hz	220-240V	kW 3	4
	380-440V	kW 4	5.5
	500-690V	kW 4	5.5

Mini Motor Contactors

Data according to IEC 947-4-1, VDE 0660, EN 60947-4-1

Main Contacts		Type	J7KNA-09-...	J7KNA-12-...
Utilization category DC1				
Switching of resistive load	1 pole	24V A	20	20
Time constant L/R ≤ 1ms		60V A	20	20
Rated operational current I _o		110V A	5	5
		220V A	0.6	0.6
3 poles in series		24V A	20	20
		60V A	20	20
		110V A	20	20
		220V A	16	16
Utilization category DC3 and DC5				
Switching of shunt motors and series motors	1 pole	24V A	20	20
		60V A	5	5
Time constant L/R ≤ 15ms		110V A	1	1
Rated operational current I _o		220V A	0.15	0.15
	3 poles in series	24V A	20	20
		60V A	20	20
		110V A	20	20
		220V A	2	2
Maximum ambient temperature				
Operation	open	°C	-40 to +60 (+90) ^{*2}	
	enclosed	°C		
with thermal overload relay	open	°C	-25 to +60	
	enclosed	°C		
Storage		°C	-50 to +90	
Short circuit protection				
for contactors without thermal overload relay				
Coordination-type "1" according to IEC 947-4-1				
Contact welding without hazard of persons max. fuse size	gL (gG)	A	40	40
Coordination-type "2" according to IEC 947-4-1				
Light contact welding accepted max. fuse size	gL (gG)	A	25	25
Contact welding not accepted max. fuse size	gL (gG)	A	10	10
For contactors with thermal overload relay the device with the smaller admissible backup fuse (contactor or thermal overload relay) determines the fuse size.				
Cable cross-sections				
for contactors without thermal overload relay				
main connector	solid or stranded	mm ²	0.5 - 2.5	0.5 - 2.5
	flexible	mm ²	0.5 - 2.5	0.5 - 2.5
	flexible with multicore cable end	mm ²	0.5 - 1.5	0.5 - 1.5
Cables per clamp			2	2
	solid or stranded	AWG	18 - 14	18 - 14

Mini Motor Contactors

Data according to IEC 947-4-1, VDE 0660, EN 60947-4-1

Main Contacts		Type	J7KNA-09-...	J7KNA-12-...
Frequency of operations z	without load	1/h	10000	10000
Contactors without thermal overload relay	AC3, I _e	1/h	600	700
	AC4, I _e	1/h	120	150
	DC3, I _e	1/h	600	700
Mechanical life AC operated	S x	10 ⁶	5	5
	DC operated	S x	15	15
Short time current	10s-current	A	96	120
Power loss per pole	at I _g /AC3 400V	W	0.15	0.25
Resistance to shock according to IEC 68-2-27				
Shock time 20ms sine-wave				
AC operated	NO	g	5	5
	NC	g	5	5
DC operated	NO	g	8	8
	NC	g	6	6

*1) Suitable at 690V for: earthed-neutral systems, overvoltage category I to IV, pollution degree 3 (standard-industry): U_{imp} = 8kV.
Data for other conditions on request.

*2) With reduced control voltage range 0.9 up to 1.0 x U_s and with reduced rated current I_g/AC1 according to I_g/AC3

Mini Motor Contactors

Data according to IEC 947-5-1, VDE 0660, EN 60947-5-1

Auxiliary Contacts		Type	J7KNA-09... J7KNA-12...	J7KNA-09...D(VS) J7KNA-12...D(VS)	J73KN-A...
Rated insulation voltage U_i		V AC	690 ^{*1}	690 ^{*1}	690 ^{*1}
Thermal rated current I_{th} to 690V					
Ambient temperature	40°C	A	10	10	10
	60°C	A	6	6	6
Power loss per pole	at I_{th}	W	0.5	0.5	0.5
Utilization category AC15					
Rated operational current I_e	220-240V	A	3	3	3
	380-415V	A	2	2	2
	440V	A	1.6	1.6	1.6
	500V	A	1.2	1.2	1.2
	660-690V	A	0.6	0.6	0.6
Utilization category DC13					
Rated operational current I_e	60V	A	2	2	2
	110V	A	0.4	0.4	0.4
	220V	A	0.1	0.1	0.1
Maximum ambient temperature					
Operation	open	°C	-40 to +60 (+90) ^{*2}		
	enclosed	°C			
Storage		°C	-40 to +90		
Short circuit protection short-circuit current 1kA, contact welding not accepted					
max. fuse size	gL (gG)	A	20	20	20
For contactors with thermal overload relay the device with the smaller admissible control fuse (contactor or thermal overload relay) determines the fuse size.					
Power consumption of coils					
AC operated	inrush	VA	25	-	-
	sealed	VA	4 - 5	-	-
		W	1.2	-	-
DC operated	inrush	W	-	2.5	-
	sealed	W	-	2.5	-
Operation range of coils in multiples of control voltage U_s					
			19 - 30V DC		
			0.85 - 1.1	0.8 - 1.1	-
Switching time at control voltage $U_s \pm 10\%$ ^{*3,*4}					
AC operated	make time	ms	15 - 25	-	-
	release time	ms	8 - 25	-	-
	arc duration	ms	10 - 15	-	-
DC operated	make time	ms	-	15 - 19	-
	release time	ms	-	8 - 25	-
	arc duration	ms	-	10 - 15	-

Mini Motor Contactors

Data according to IEC 947-5-1, VDE 0660, EN 60947-5-1

Auxiliary Contacts	Type	J7KNA-09... J7KNA-12...	J7KNA-09...D(VS) J7KNA-12...D(VS)	J73KN-A...
Cable cross-section				
all connectors	solid	mm ² 0.75 - 2.5	0.75 - 2.5	0.75 - 2.5
	flexible	mm ² 0.75 - 2.5	0.75 - 2.5	0.75 - 2.5
	flexible with multicore cable end	mm ² 0.5 - 1.5	0.5 - 1.5	0.5 - 2.5
Clamps per pole		2	2	2
	solid or stranded	AWG 18 - 14	18 - 14	18 - 14

*1) Suitable at 690V for: earthed-neutral systems, overvoltage category I to IV, pollution degree 3 (standard-industry): $U_{imp} = 8kV$.
Data for other conditions on request.

*2) With reduced control voltage range 0.9 up to $1.0 \times U_s$ and with reduced thermal rated current I_{th} to $I_e/AC15$

*3) Summary switching time = release time + arc duration

*4) Release time of NC make time of NO increase when suppressor units for voltage peak protection are used (Varistor, RC-units, Diode units).

Mini Contactors for North America

Data according to UL508

Main Contacts (cULus)	Type	J7KNA-09...	J7KNA-12...	J73KN-A...
Rated operational current "General Use"	A	15	20	10
Rated operational power of three-phase motors at 60Hz (3ph)	115V hp	1½	2	-
	200V hp	3	3	-
	230V hp	3	3	-
	460V hp	5	7½	-
	575V hp	7½	10	-
Rated operational power of AC motors at 60Hz (1ph)	115V hp	½	¾	-
	200V hp	1	1½	-
	230V hp	1½	2	-
Fuses	A	30	30	-
Suitable for use on a capability of delivering not more than rms	A	5000	5000	-
	V	600	600	-
Rated voltage	V AC	600	600	600
Auxiliary Contacts (cULus)	heavy pilot duty	AC A600	A600	A600
	standard pilot duty	DC Q600	Q600	Q600

■ Dimensions

AC and DC operated
with screw terminals

Auxiliary Contact Blocks

J7KNA-09...
J7KNA-12...

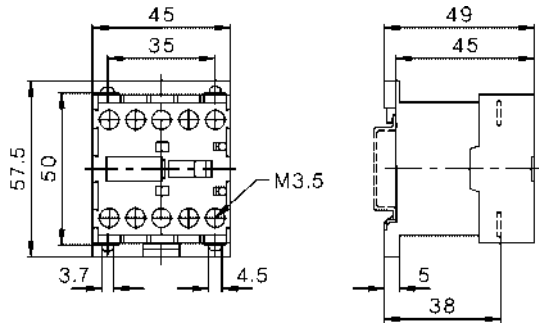

J73KN-A...

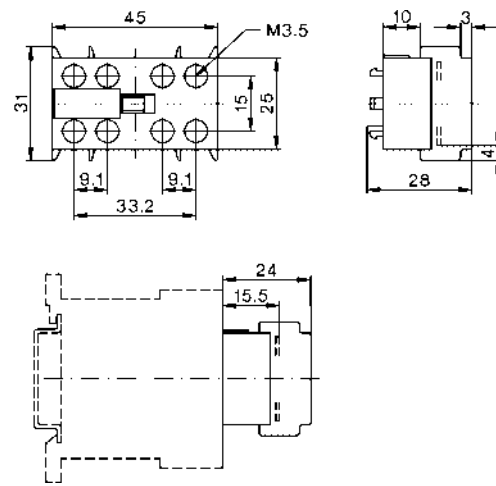

Reversing Contactors

J7KNA-09-01-W...
J7KNA-12-01-W...

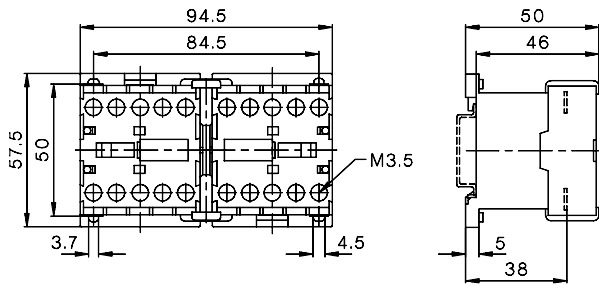

J7KNA-09-01-W... + J7TKN-A
J7KNA-12-01-W... + J7TKN-A

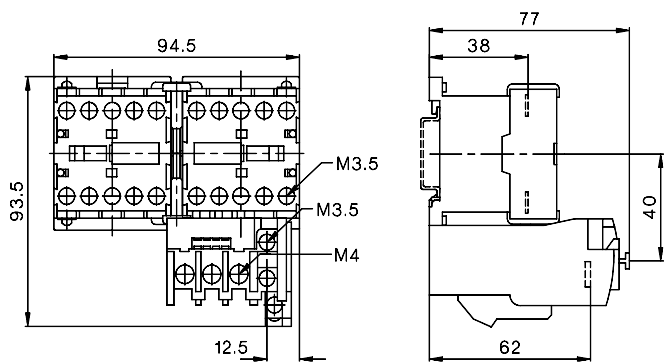

ALL DIMENSIONS SHOWN ARE IN MILLIMETERS.

Motor Contactor J7KN

Main contactor

- AC & DC operated
- Integrated auxiliary contacts
- Screw fixing and snap fitting (35 mm DIN rail) up to 45 kW
- Range from 4 to 110 kW (AC 3, 380/415V)
- Finger proof (VBG 4)

Accessories

- front mounted single pole additional auxiliary contacts (1 NO or 1 NC)
- Side mounted additional auxiliary contacts (1 NO/1 NC)
- Mechanical interlock
- Suppressors (RC and varistor)
- Pneumatic timer modules
- Link modules MPCB - Motor contactor



Approved Standards

Standard	Guide No (US,C)
UL	NLDX, NLDX7
ICE 947-4-1	
VDE 0660	
EN 60947-4-1	

Ordering Information

Model Number Legend

1. Motor Contactors

J7KN-□□□□□□□□
 1 2 3 4

- 1) Motor Contactor
- 2) Rated Motor Current (AC3 400V)
 - 10: 10A
 - 14: 14A
 - 18: 18A
 - 22: 22A
 - 24: 24A
 - 32: 32A
 - 40: 40A
 - 50: 50A
 - 62: 62A
 - 74: 74A
 - 85: 85A
 - 110: 110A
 - 150: 150A
 - 175: 175A
 - 200: 200A
- 3) Integrated auxiliary contact
 - 10: 1NO 0NC
 - 01: 0NO 1NC
 - 21: 2NO 1NC
 - 22: 2NO 2NC
 - : 0NO 0NC
- 4) Coil voltage (AC operated)
 - 24: AC24V 50/60Hz
 - 48: AC48V 50Hz
 - 110: AC110V 50Hz, AC110-120V 60Hz
 - 180: AC180-210V 50Hz, AC200-240V 60Hz
 - 230: AC220-240V 50Hz, AC240V 60Hz
 - 400: AC380-415V 50Hz, AC415-440V 60Hz
 - 500: AC500-550V 50Hz, AC550-600V 60Hz

Coil voltage(DC operated)

 - 24D: DC24V
 - 48D: DC48V
 - 110D: DC110V
 - 125D: DC125V

2. Aux. Contact Modules for Motor Contactors

J73KN-□□□□□□
 1 2 3 4

- 1) Auxiliary Contact Modules
- 2) B: for motor contactor (4-37kW)
 C: for motor contactor (11-37kW)
- 3) Combination of NO/NC contacts
 - 10: 1NO 0NC
 - 01: 0NO 1NC
 - 11: 1NO 1NC
- 4) S: side mounting
 : front mounting

3. Accessories for Motor Contactors (Link Modules MPCB - Motor Contactor)

J74KN-□□□□□□
 1 2 3

- 1) Accessories for Motor Contactors
- 2) VD: Link module type
 HU: DIN-rail adapter type
- 3) 12: for motor contactor (4 - 7.5kW)
 25: for motor contactor (11 - 15kW)

4. Accessories for Motor Contactors (Pneumatic Timers)

J74KN-□□□□□□□□
 1 2 3 4 5

- 1) Accessories for Motor Contactors
- 2) B: Motor Contactor (4-11kW)
- 3) TP: Pneumatic Timer
- 4) 40: 40 sec
 180: 180 sec
- 5) DA: ON-delayed
 IA: OFF-delayed

5. Accessories for Motor Contactors (Mechanical Interlock)

J74KN-□□□□□□
 1 2 3

- 1) Accessories for Motor Contactors
- 2) B: Motor Contactor (4-18.5kW)
 C: Motor Contactor (11-37kW)
 D: Motor Contactor (45-55kW)
- 3) ML: Mechanical Interlock

6. Accessories for Motor Contactors (RC Suppressor units)

J74KN-□□□□□□□□
 1 2 3 4

- 1) Accessories for Motor Contactors
- 2) A: for Mini Motor Contactor and Motor Contactor (4-18.5kW)
 (between DIN-rail and Contactor)
 B: for Mini Motor Contactor and Motor Contactor (4-55kW)
 C: for Motor Contactor (4-37kW) to snap on the contactor
- 3) RC: RC-surge suppressors
- 4) 48: 24 - 48 VAC/DC (A+B type)
 230: 110 - 230 VAC/DC (A+B type)
 400: 250 - 415 VAC/DC (A+B type)
 24: 12 - 48 VAC/DC (C type)
 110: 48 - 127 VAC/DC (C type)
 230: 110 - 250 VAC/DC (C type)

7. Accessories for Motor Contactors (Varistor units)

J74KN-□□□□□□□□
 1 2 3 4

- 1) Accessories for Motor Contactors
- 2) A: for Motor Contactor (4-11kW) to snap on to coil terminals
 B: for Motor Contactor (4-37kW) to snap on to contactor
- 3) VG: Varistor Suppressors
- 4) 230: 110-230VAC/DC
 400: 250-415VAC/DC







LVSG

List of Models



Contactors 3-pole

- Up to 210A AC3
- Up to 350A AC1
- DIN-rail mounting up to AC3 74A
- International Approvals
- Data according to IEC 947 / EN 60947







Ratings											
AC3	400V Motor	10A	14A	18A	22A	24A	32A	40A	50A	62A	74A
	380-400V	4kW	5,5kW	7,5kW	11kW	11kW	15kW	18,5kW	22kW	30kW	37kW
	660-690V	5,5kW	7,5kW	10kW	10kW	15kW	18,5kW	18,5kW	30kW	37kW	45kW
AC1	690V at 40°C	25A	25A	32A	32A	50A	65A	80A	110A	120A	130A
Type		J7KN-10-10	J7KN-14-10	J7KN-18-10	J7KN-22-10	J7KN-24	J7KN-32	J7KN-40	J7KN-50	J7KN-62	J7KN-74
Auxiliary contacts		1NO	1NO	1NO	1NO	-	-	-	-	-	-
Type		J7KN-10-01	J7KN-14-01	J7KN-18-01	J7KN-22-01	-	-	-	-	-	-
Auxiliary contacts		1NC	1NC	1NC	1NC	-	-	-	-	-	-
Cable cross-section											
Solid	mm ²	0,75 - 6				1,5 - 25			4 - 50		
Flexible	mm ²	1 - 4				2,5 - 16			10 - 35		
Cables per clamp		2				1 + 1			1 + 1		
Auxiliary contact											
I _{th}	40°C	A 16									
AC15	230V	A 12									
	400V	A 4									
Power consumption of coils											
	Inrush VA	33 - 45				90 - 115			140 - 165		
	Hold VA	7 - 10				9 - 13			13 - 18		
	Operation range of coils	0,85 - 1,1				0,85 - 1,1			0,85 - 1,1		
Mounting		35mm DIN-rail or base									
Additional aux. contact blocks											
Front mounting contacts	Type	 J73KN-B-10 1NO f. low level switching				 J73KN-B-01 1NC f. low level switching					
		maximal 4 J73KN-B..									
Additional aux. contact blocks											
Side mounting contacts	Type	-	-	-	-	 J73KN-C-11S 1NO+1NC f. low level switching max. 2 J73KN-C-11S					
Overload Relay (thermal)											
Single phase protection Temperature compensation Trip and alarm contacts											
	Type	J7TKN-B		J7TKN-A		J7TKN-C		J7TKN-D			
	Setting Ranges	Setting Ranges		Setting Ranges		Setting Ranges		Setting Ranges			
		0,12 - 0,18A		1,8 - 2,7A		28 - 42A		20 - 28A			
		0,18 - 0,27A		2,7 - 4A				28 - 42A			
		0,27 - 0,4A		4 - 6A				40 - 52A			
		0,4 - 0,6A		6 - 9A				52 - 65A			
		0,6 - 0,9A		8 - 11A				60 - 74A			
		0,8 - 1,2A		10 - 14A							
		1,2 - 1,8A		13 - 18A							
		17 - (23)24A		(22)23 - (30)32A							



Ratings						
AC3	400V Motor	85A	110A	150A	175A	210A
	380-400V	45kW	55kW	75kW	90kW	110kW
	660-690V	55kW	55kW	75kW	110kW	132kW
AC1	690V at 40°C	150A	170A	200A	250A	350A
Type		J7KN-85-22	J7KN-110-22	J7KN-150-11	J7KN-175-11	J7KN-200-22
Auxiliary contacts		2NO+2NC	2NO+2NC	1NO+1NC	1NO+1NC	2NO+2NC
Type		-	-	-	-	-
Auxiliary contacts		-	-	-	-	-
Cable cross-section						
Solid	mm ²	10 - 70	10 - 70	busbar	busbar	busbar
Flexible	mm ²	16 - 50	16 - 50	18x5	18x5	22x4
Cables per clamp		1	1	1	1	1
Auxiliary contact						
I _{th}	40°C	A 16		10		
AC15	230V	A 12		3		
	400V	A 6		2		
Power consumption of coils						
	Inrush VA	350 - 420		550	550	1100
	hold VA	23 - 29		130	130	66
	Operation range of coils	0,85 - 1,1		0,85 - 1,1		
Mounting		base				
Additional aux. contact blocks						
Front mounting contacts	Type					
Additional aux. contact blocks						
Side mounting contacts	Type	-	-	-	-	-
Overload Relay (thermal)						
Single phase protection Temperature compensation Trip and alarm contacts						
Type		J7TKN-E		J7TKN-F		
	Setting Ranges	60 - 90A		100 - 150A		
		80 - 120A		140 - 220A		
		Busbar Sets				
		J74TK-SU-175, J74TK-SU-200				

LVSG

Contactors 3-pole
AC Operated

	Ratings			Rated Current AC1 690V A	Aux. Contacts		Type	Pack	Weight		
	AC2, AC3				Built-in					Additional see page 34 Type	
	380V 400V 415V kW	500V kW	660V 690V kW		NO	NC					
	4	5.5	5.5	25	1	-	max. 4 J73KN-B	Coil Voltage ^{*1} 24V 50/60Hz 110V 50Hz 220-240V 50Hz	pcs.	kg/pc.	J7KN-10-10□□□□
	4	5.5	5.5	25	-	1					J7KN-10-01□□□□
	5.5	7.5	7.5	25	1	-					J7KN-14-10□□□□
	5.5	7.5	7.5	25	-	1					J7KN-14-01□□□□
	7.5	10	10	32	1	-					J7KN-18-10□□□□
	7.5	10	10	32	-	1					J7KN-18-01□□□□
	11	10	10	32	1	-					J7KN-22-10□□□□
	11	10	10	32	-	1					J7KN-22-01□□□□
	11	15	15	50	-	-	max. 4 J73KN-B + 2 J73KN- C-11S	Coil Voltage ^{*1} 220-230V 50Hz 380-400V 50Hz	pcs.	kg/pc.	J7KN-24□□□□
	15	18.5	18.5	65	-	-					J7KN-32□□□□
	18.5	18.5	18.5	80	-	-					J7KN-40□□□□
	22	30	30	110	-	-	max. 4 J73KN-B + 2 J73KN- C11S	Coil Voltage ^{*1} 220-230V 50Hz 380-400V 50Hz	pcs.	kg/pc.	J7KN-50□□□□
	30	37	37	120	-	-					J7KN-62□□□□
	37	45	45	130	-	-					J7KN-74□□□□
	Ratings			Rated Current AC1 690V A	Aux. Contacts		Type	Pack	Weight		
	AC2, AC3				Built-in						
	380V 415V kW	500V kW	660V 690V kW		NO	NC					
	45	55	55	150	2	2		Coil Voltage ^{*1} 220-230V 50Hz 380-400V 50Hz	pcs.	kg/pc.	J7KN-85-22□□□□
	55	75	55	170	2	2					J7KN-110-22□□□□
	75	75	75	200	1	1		Coil Voltage ^{*1} 220-230V 50Hz 380-400V 50Hz	pcs.	kg/pc.	J7KN-150-11□□□□
	90	90	90	250	1	1					J7KN-175-11□□□□
	110	132	132	350	2	2					J7KN-200-22□□□□

*1) Coil voltage range and other coil voltages see page 37

Contactors 3-pole
DC Operated

Type	Coil voltage		Aux. Contacts			Weight kg/pc.	Accept Overload Relay page 57 Type	Busbar Set for Overload Relay page 59 Type	Wiring Diagram Coil Circuits see page 36 Terminal Markings
	24 60 110 220	24V DC 60V DC 110V DC 220V DC	Built-in		Additional ^{*1)} Type				
			NO	NC					
J7KN-10-10□□□□D			1	-	max. 3 J73KN-B	0.25	J7TKN-B	-	
J7KN-10-01□□□□D			-	1		0.25	J7TKN-A	-	
J7KN-14-10□□□□D			1	-		0.25		-	
J7KN-14-01□□□□D			-	1		0.25		-	
J7KN-18-10□□□□D			1	-		0.25		-	
J7KN-18-01□□□□D			-	1		0.25		-	
J7KN-22-10□□□□D			1	-		0.25		-	
J7KN-22-01□□□□D			-	1		0.25		-	
J7KN-24□□□□D			-	-	max. 3 J73KN-B	0.55	J7TKN-B	-	
J7KN-32□□□□D			-	-	+ 2 J73KN-C-11S	0.55	J7TKN-C	-	
J7KN-40□□□□D			-	-		0.55		-	
J7KN-50□□□□D			-	-	max. 3 J73KN-B	0.9	J7TKN-D	-	
J7KN-62□□□□D			-	-	+ 2 J73KN-C-11S	0.9		-	
J7KN-74□□□□D			2	1		1.6		-	
Type	Coil voltage		Aux. Contacts			Weight kg/pc.	Accept Overload Relay page H-57 Type	Busbar Set for Overload Relay page H-57 Type	-22
	110 220	110V DC 220V DC	NO	NC					
J7KN-85-21□□□□D			2	1	-	1.8	J7TKN-E		
J7KN-110-21□□□□D			2	1	-	1.9			
							J7TKN-F	J73TK-SU-175 J73TK-SU-200	

*1) Only 3 additional Aux. Contacts are possible! (See also the wiring diagrams coil circuit DC operated page 36)

Contactors 4-pole
AC Operated

	Ratings		Rated Current AC1 690V	Aux. Contacts		Type	Pack	Weight	
	AC2, AC3 380V 400V 415V kW	AC1 400V kW		Built-in	Additional see below				Coil Voltage*1
				NO	NC	Type	pcs.	kg/pc.	
	4	17.5	25	-	-	max. 4 J73KN-B	J7KN-10-4□□□□	1	0.22

*1) Coil voltage range and other coil voltages see page 37

Auxiliary Contact Blocks for contactors J7KN-10... to -74... type J73KN for low level switching*1

Front mounting	Rated Operational Current			Contacts				Type	Pack	Weight
	AC15 230V	AC15 400V	AC1 690V	NO	NC	EM	LB			
	A	A	A						pcs.	kg/pc.
	3	2	10	1	-	-	-	J73KN-B-10	10	0.02
	3	2	10	-	1	-	-	J73KN-B-01	10	0.02

Auxiliary Contact Blocks for contactors J7KN-24... to -74... type J73KN for low level switching*1

Side mounting	Rated Operational Current			Contacts	Type	Pack	Weight	
	AC15 230V	AC15 400V	AC1 690V					
	A	A	A	NO	NC	pcs.	kg/pc.	
	3	2	10	max. 2		J73KN-C-11S	10	0.02

Pneumatic Timer for contactors J7KN-10... to -22...



	Function	Time range s	Contacts				Type	Pack pcs.	Weight kg/pc.
			NO	NC	NO	NC			
	On-delay	0.1 - 40	1	1	-	-	J74KN-B-TP40DA	1	0.09
	On-delay	10 - 180	1	1	-	-	J74KN-B-TP180DA	1	0.09
	Off-delay	0.1 - 40	-	-	1	1	J74KN-B-TP40IA	1	0.09
	Off-delay	10 - 180	-	-	1	1	J74KN-B-TP180IA	1	0.09

1. suitable according to DIN 19240 (test ratings 17V DC, 5mA)
Technical data see page 51

Mechanical Interlocks

	Interlocks contactor with contactor		Mounting	Type	Pack pcs.	Weight kg/pc.
	Type	+ Type				
	J7KN10 - J7KN40	+ J7KN10 - J7KN40	horizontal	J74KN-B-ML	1	0.006
	J7KN24 - J7KN74	+ J7KN24 - J7KN74	horizontal	J74KN-C-ML	1	0.010
	J7KN85 - J7KN110	+ J7KN85 - J7KN110	horizontal	J74KN-D-ML	1	0.076

Suppressor Units

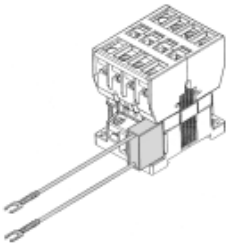
	Voltage Range V	Mounting	Type	Pack pcs.	Weight kg/pc.
	Varistor for contactors J7KN-10 to J7KN-22				
	110 - 230V AC/DC	to snap on to coil terminals	J74KN-A-VG230	10	0.01
	250 - 415V AC/DC	to snap on to coil terminals	J74KN-A-VG400	10	0.01
	Varistor for contactors J7KN-10 to J7KN-74				
	110 - 230V AC/DC	to snap on the contactor	J74KN-B-VG230	10	0.02
	250 - 415V AC/DC	to snap on the contactor	J74KN-B-VG400	10	0.02
	RC-unit for contactors J7KN-10 to J7KN-40, J7KNA				
	110 - 230V AC/DC	between DIN-rail and contactor	J74KN-A-RC230	1	0.036
	RC-units for contactors J7KN-10 to J7KN-110				
	24 - 48V AC/DC	universal (fixing band, adhesive strip)	J74KN-B-RC48	5	0.02
	110 - 230V AC/DC	universal (fixing band, adhesive strip)	J74KN-B-RC230	5	0.02
	250 - 415V AC	universal (fixing band, adhesive strip)	J74KN-B-RC400	5	0.02
	RC-units for contactors J7KN-10 to J7KN-74				
	12 - 48V AC (50/60Hz) & DC	to snap on the contactor	J74KN-C-RC24	10	0.02
	48 - 127V AC (50/60Hz) & DC	to snap on the contactor	J74KN-C-RC110	10	0.036
	110 - 250V AC (50/60Hz) & DC	to snap on the contactor	J74KN-C-RC230	10	0.036

LVSG

■ Wiring Diagrams Coil Circuit

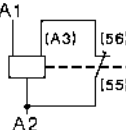
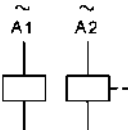
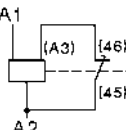
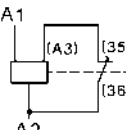
AC operated	DC operated with double winding coil*1
J7KN-10... to J7KN-175... 	J7KN-10...D to J7KN-22...D 
J7KN-200... 	J7KN-24...D to J7KN-74...D 
	J7KN-85...D to J7KN-110...D 

*1) Only 3 additional Aux. Contacts are possible! (See also page 33)

Specifications

■ Coil Voltages

Type-suffix for contactor types J7KN-10... to J7KN-74...

Suffix to contactor type e.g. J7KN-10-10-24	Voltage Marking at the coil		Rated Control Voltage U _s range for			
	for 50Hz V	for 60Hz V	50Hz		60Hz	
			min V.	max V.	min V.	max V.
24	24	24	22	24	24	27
48	48		47	52	52	58
110	110	110-120	100	110	110	122
180	180-210	200-240	180	210	200	240
230	220-240	240	220	240	240	264
400	380-415	415-440	380	415	415	460
500	500-550	550-600	500	550	550	600

Standard voltages in bold type letter

Type-suffix for contactor types J7KN-85... to J7KN-110...

Suffix to contactor type e.g. J7KN-85-22-24	Voltage Marking at the coil		Rated Control Voltage U _s range for			
	for 50Hz V	for 60Hz V	50Hz		60Hz	
			min V.	max V.	min V.	max V.
24	24		24	27	29	32
48	48	60	47	52	56	62
110	110-120		110	122	132	146
180	180-200	208-240	180	200	208	240
230	220-240	277	220	240	264	288
400	380-415	460-480	380	415	455	498
500	500-550	600-660	500	550	600	660

Standard voltages in bold type letter

Type-suffix for contactor types J7KN-150... to J7KN-200...

Suffix to contactor type e.g. J7KN-150-110	Voltage Marking at the coil		Rated Control Voltage U _s range for			
	for 50Hz V	for 60Hz V	50Hz		60Hz	
			min V.	max V.	min V.	max V.
24	24		24	24	-	-
48	48		48	48	-	-
110	110	110	110	110	110	110
180	180	220	180	180	220	220
230	220-230	220	220	230	220	220
240	240	240	240	240	240	240
400	380-400		380	400	-	-
440		440	-	-	440	440

Standard voltages in bold type letter

■ Engineering data and characteristics

Approximate Values for three-phase Motors

Motor Full Load Currents

Approximate values of motor F.L.C. and minimum „slow blow“ respectively „gL“ short-circuit fuse

Motor rating Range according to BS for 415V					220-230V Motor Value of fusing at motor start			240V Motor Value of fusing at motor start			380-400V Motor Value of fusing at motor start			415V Motor Value of fusing at motor start			500V Motor Value of fusing at motor start			660-690V Motor Value of fusing at motor start		
kW	PS-hp	hp	cosφ	%	F.L.C. A	D.O.L. A	YD A	F.L.C. A	D.O.L. A	YD A	F.L.C. A	D.O.L. A	YD A	F.L.C. A	D.O.L. A	YD A	F.L.C. A	D.O.L. A	YD A	F.L.C. A	D.O.L. A	YD A
0.06	0.08	-	0.7	59	0.38	1	1	0.35	1	1	0.22	1	1	-	-	-	0.16	1	1	-	-	-
0.09	0.12	-	0.7	60	0.55	2	2	0.5	2	2	0.33	1	1	-	-	-	0.24	1	1	-	-	-
0.12	0.16	-	0.7	61	0.76	2	2	0.68	2	2	0.42	2	2	-	-	-	0.33	1	1	-	-	-
0.18	0.24	-	0.7	61	1.1	2	2	1	2	2	0.64	2	2	-	-	-	0.46	1	1	-	-	-
0.25	0.34	-	0.7	62	1.4	4	2	1.38	4	2	0.88	2	2	-	-	-	0.59	2	2	-	-	-
0.37	0.5	-	0.72	64	2.1	4	4	1.93	4	4	1.22	4	2	-	-	-	0.85	2	2	0.7	2	2
0.55	0.75	-	0.75	69	2.7	4	4	2.3	4	4	1.5	4	2	-	-	-	1.2	4	2	0.9	2	2
0.75	1	1	0.8	74	3.3	6	4	3.1	6	4	2	4	4	2	4	4	1.48	4	2	1.1	2	2
1.1	1.5	1.5	0.83	77	4.9	10	6	4.1	6	6	2.6	4	4	2.5	4	4	2.1	4	4	1.5	4	2
1.5	2	2	0.83	78	6.2	10	10	5.6	10	10	3.5	6	4	3.5	6	4	2.6	4	4	2	4	4
2.2	3	3	0.83	81	8.7	16	10	7.9	16	10	5	10	6	5	10	6	3.8	6	6	2.9	6	4
2.5	3.4	-	0.83	81	9.8	16	16	8.9	16	10	5.7	10	10	-	-	-	4.3	6	6	-	-	-
3	4	4	0.84	81	11.6	20	16	10.6	20	16	6.6	16	10	6.5	16	10	5.1	10	10	3.5	6	4
3.7	5	5	0.84	82	14.2	25	20	13	25	16	8.2	16	10	7.5	16	10	6.2	16	10	-	-	-
4	5.5	-	0.84	82	15.3	25	20	14	25	20	8.5	16	10	-	-	-	6.5	16	10	4.9	10	6
5.5	7.5	7.5	0.85	83	20.6	35	25	18.9	35	25	11.5	20	16	11	20	16	8.9	16	10	6.7	16	10
7.5	10	10	0.86	85	27.4	35	35	24.8	35	35	15.5	25	20	14	25	16	11.9	20	16	9	16	10
8	11	-	0.86	85	28.8	50	35	26.4	35	35	16.7	25	20	-	-	-	12.7	20	16	-	-	-
11	15	15	0.86	87	39.2	63	50	35.3	50	50	22	35	25	21	35	25	16.7	25	20	13	25	16
12.5	17	-	0.86	87	43.8	63	50	40.2	63	50	25	35	35	-	-	-	19	35	25	-	-	-
15	20	20	0.86	87	52.6	80	63	48.2	80	63	30	50	35	28	35	35	22.5	35	25	17.5	25	20
18.5	25	25	0.86	88	64.9	100	80	58.7	80	63	37	63	50	35	50	50	28.5	50	35	21	35	25
20	27	-	0.86	88	69.3	100	80	63.4	80	80	40	63	50	-	-	-	30.6	50	35	-	-	-
22	30	30	0.87	89	75.2	100	80	68	100	80	44	63	50	40	63	50	33	50	50	25	35	35
25	34	-	0.87	89	84.4	125	100	77.2	100	100	50	80	63	-	-	-	38	63	50	-	-	-
30	40	40	0.87	90	101	125	125	92.7	125	100	60	80	63	55	80	63	44	63	50	33	50	35
37	50	50	0.87	90	124	160	160	114	160	125	72	100	80	66	100	80	54	80	63	42	63	50
40	54	-	0.87	90	134	160	160	123	160	160	79	100	100	-	-	-	60	80	63	-	-	-
45	60	60	0.88	91	150	200	160	136	200	160	85	125	100	80	100	100	64.5	100	80	49	63	63
51	70	-	0.88	91	168	200	200	154	200	200	97	125	100	-	-	-	73.7	100	80	-	-	-
55	75	-	0.88	91	181	250	200	166	200	200	105	160	125	-	-	-	79	125	100	60	80	63
59	80	80	0.88	91	194	250	250	178	250	200	112	160	125	105	160	125	85.3	125	100	-	-	-
75	100	100	0.88	91	245	315	250	226	315	250	140	200	160	135	200	160	106	160	125	82	125	100
90	125	125	0.88	92	292	400	315	268	315	315	170	250	200	165	200	200	128	160	160	98	125	125
110	150	150	0.88	92	358	500	400	327	400	400	205	250	250	200	250	250	156	200	200	118	160	125
129	175	175	0.88	92	420	500	500	384	500	400	242	315	250	230	315	250	184	250	200	-	-	-
132	180	-	0.88	92	425	500	500	393	500	500	245	315	250	-	-	-	186	250	200	140	200	160
147	200	200	0.88	93	472	630	630	432	630	500	273	315	315	260	315	315	207	250	250	-	-	-
160	220	-	0.88	93	502	630	630	471	630	630	295	400	315	-	-	-	220	315	250	170	200	200
184	250	250	0.88	93	590	800	630	541	630	630	340	400	400	325	400	400	259	315	315	-	-	-
200	270	-	0.88	93	626	800	800	589	800	630	370	500	400	-	-	-	278	315	315	215	250	250
220	300	300	0.88	93	700	1000	800	647	800	800	408	500	500	385	500	400	310	400	400	-	-	-
250	340	-	0.88	93	803	1000	1000	736	1000	800	460	630	500	-	-	-	353	500	400	268	315	315
257	350	350	0.88	93	826	1000	1000	756	1000	800	475	630	630	450	630	500	363	500	400	-	-	-
295	400	400	0.88	93	948	1250	1000	868	1000	1000	546	800	630	500	630	630	416	500	500	-	-	-
315	430	-	0.88	93	990	1250	1250	927	1250	1000	580	800	630	-	-	-	445	630	500	337	400	400
355	483	-	0.89	95	-	-	-	-	-	-	636	800	800	-	-	-	483	630	630	366	500	400
400	545	-	0.89	96	-	-	-	-	-	-	710	1000	800	-	-	-	538	630	630	410	500	500

The motor F.L.C. be valid for standard internal and surface cooled three-pole motors with 1500 min⁻¹. The fuses values be valid for the motor F.L.C. shown in the table and D.O.L.-start: starting current max. 6x motor F.L.C., starting time max. 5s; star-delta-start: starting current max. 2x motor F.L.C., starting time max. 15s. For motors with higher F.L.C., higher starting current and / or longer starting time, larger short-circuit fuses are required.

The maximum admissible value is dependent on the switchgear respectively thermal overload relay.

Approximate values of motor F.L.C. according to CSA and UL

Motor rating hp	Motor F.L.C. at 110-120V			Motor F.L.C. at 220-240V*1			Motor F.L.C. at 440-480V			Motor F.L.C. at 550-600V		
	1-phase A	2-phase A	3-phase A	1-phase A	2-phase A	3-phase A	1-phase A	2-phase A	3-phase A	1-phase A	2-phase A	3-phase A
½	9.8	4.0	4.4	4.9	2.0	2.2	2.5	1.0	1.1	2.0	0.8	0.9
¾	13.8	4.8	6.4	6.9	2.4	3.2	3.5	1.2	1.6	2.8	1.0	1.3
1	16.0	6.4	8.4	8.0	3.2	4.2	4.0	1.6	2.1	3.2	1.3	1.7
1½	20.0	9.0	12.0	10.0	4.5	6.0	5.0	2.3	3.0	4.0	1.8	2.4
2	24.0	11.8	13.6	12.0	5.9	6.8	6.0	3.0	3.4	4.8	2.4	2.7
3	34.0	16.6	19.2	17.0	8.3	9.6	8.5	4.2	4.8	6.8	3.3	3.9
5	56.0	26.4	30.4	28.0	13.2	15.2	14.0	6.6	7.6	11.2	5.3	6.1
7½	80.0	38.0	44.0	40.0	19.0	22.0	21.0	9.0	11.0	16.0	8.0	9.0
10	100.0	48.0	56.0	50.0	24.0	28.0	26.0	12.0	14.0	20.0	10.0	11.0
15	135.0	72.0	84.0	68.0	36.0	42.0	34.0	18.0	21.0	27.0	14.0	17.0
20	-	94.0	108.0	88.0	47.0	54.0	44.0	23.0	27.0	35.0	19.0	22.0
25	-	118.0	136.0	110.0	59.0	68.0	55.0	29.0	34.0	44.0	24.0	27.0
30	-	138.0	160.0	136.0	69.0	80.0	68.0	35.0	40.0	54.0	28.0	32.0
40	-	180.0	208.0	176.0	90.0	104.0	88.0	45.0	52.0	70.0	36.0	41.0
50	-	226.0	260.0	216.0	113.0	130.0	108.0	56.0	65.0	86.0	45.0	52.0
60	-	-	-	-	133.0	145.0	-	67.0	77.0	-	53.0	62.0
75	-	-	-	-	166.0	192.0	-	83.0	96.0	-	66.0	77.0
100	-	-	-	-	218.0	248.0	-	109.0	124.0	-	87.0	99.0
125	-	-	-	-	-	312.0	-	135.0	156.0	-	108.0	125.0
150	-	-	-	-	-	360.0	-	156.0	180.0	-	125.0	144.0
200	-	-	-	-	-	480.0	-	208.0	240.0	-	167.0	192.0
250	-	-	-	-	-	602.0	-	-	302.0	-	-	242.0
300	-	-	-	-	-	-	-	-	361.0	-	-	289.0
350	-	-	-	-	-	-	-	-	414.0	-	-	336.0
400	-	-	-	-	-	-	-	-	477.0	-	-	382.0
500	-	-	-	-	-	-	-	-	590.0	-	-	472.0

*1) Determine the motor current for 200V and 208V by increasing the values for 220-240V at 200V about 15% and for 208V about 10%.

Contactors

Data according to IEC 947-4-1, EN 60947-4-1, VDE 0660

Main Contacts	Type	J7KN-10	J7KN-14	J7KN-18	J7KN-22	J7KN-24	J7KN-32	J7KN-40	J7KN-50	J7KN-62	J7KN-74
Rated insulation voltage U_i^{-1}	V AC	690	690	690	690	690	690	690	690	690	690
Making capacity I_{mf}	at $U_n = 690V$ AC A	200	200	200	200	400	500	500	700	900	900
Breaking capacity I_{bf}	400V AC A	180	180	200	200	380	400	400	600	800	800
J7KN-10 to J7KN-22 $\cos\phi = 0,65$	500V AC A	150	150	180	180	300	370	370	500	700	700
J7KN-24 to J7KN-72 $\cos\phi = 0,35$	690V AC A	100	100	150	150	260	340	340	400	500	500
	1000V AC A	-	-	-	-	-	-	-	-	-	-
Utilization category AC1											
Switching of resistive load											
Rated operational current $I_n (=I_{n0})$ at 40°C, open	A	25	25	32	32	50	65	80	110	120	130
Rated operational power of three-phase resistive loads 50-60Hz, $\cos\phi = 1$	220V kW	9,5	9,5	12,2	12,2	19,0	24,7	30,4	41,9	45,7	49,5
	230V kW	9,9	9,9	12,7	12,7	19,9	25,9	31,8	43,8	47,7	51,7
	240V kW	10,4	10,4	13,3	13,3	20,8	27,0	33,2	45,7	49,8	54,0
	380V kW	16,4	16,4	21,0	21,0	32,9	42,7	52,6	72,3	78,9	85,5
	400V kW	17,3	17,3	22,1	22,1	34,6	45,0	55,4	76,1	83,0	90,0
	415V kW	17,9	17,9	23,0	23,0	35,9	46,7	57,4	79,0	86,2	93,3
	440V kW	19,0	19,0	24,4	24,4	38,1	49,5	60,9	83,7	91,3	99,0
	500V kW	21,6	21,6	27,7	27,7	43,3	56,2	69,2	95,2	103,8	112,5
	660V kW	28,5	28,5	36,5	36,5	57,1	74,2	91,3	125,6	137,0	148,4
	690V kW	29,8	29,8	38,2	38,2	59,7	77,6	95,5	131,3	143,2	155,2
	1000V kW	-	-	-	-	-	-	-	-	-	-
Rated operational current $I_n (=I_{n0})$ at 60°C, enclosed	A	25	25	32	32	40	55	65	90	100	110
Rated operational power of three-phase resistive loads 50-60Hz, $\cos\phi = 1$	220V kW	9,5	9,5	12,2	12,2	15,2	20,9	24,7	34,3	38,1	41,9
	230V kW	9,9	9,9	12,7	12,7	15,9	21,9	25,9	35,8	39,8	43,8
	240V kW	10,4	10,4	13,3	13,3	16,6	22,8	27,0	37,4	41,5	45,7
	380V kW	16,4	16,4	21,0	21,0	26,3	36,2	42,7	59,2	65,7	72,3
	400V kW	17,3	17,3	22,1	22,1	27,7	38,1	45,0	62,3	69,2	76,1
	415V kW	17,9	17,9	23,0	23,0	28,7	39,5	46,7	64,6	71,8	79,0
	440V kW	19,0	19,0	24,4	24,4	30,4	41,9	49,5	68,5	76,1	83,7
	500V kW	21,6	21,6	27,7	27,7	34,6	47,6	56,2	77,9	86,5	95,2
	660V kW	28,5	28,5	36,5	36,5	45,7	62,8	74,2	102,8	114,2	125,6
	690V kW	29,8	29,8	38,2	38,2	47,7	65,7	77,6	107,4	119,4	131,3
	1000V kW	-	-	-	-	-	-	-	-	-	-
Minimum cross-section of conductor at load with $I_n (=I_{n0})$	mm ²	4	4	6	6	10	16	25	35	50	50
Utilization category AC2 and AC3											
Switching of three-phase motors											
Rated operational current I_n open and enclosed	220V A	12	15	18	22	24	30	40	50	63	74
	230V A	11,5	14,5	18	22	24	30	40	50	62	74
	240V A	11	14	18	22	24	32	40	50	62	74
	380-400V A	10	14	18	22	24	32	40	50	62	74
	415V A	9	14	18	22	23	30	40	50	62	74
	440V A	9	14	18	22	23	30	40	50	62	74
	500V A	7	9	9	9	17,5	21	21	33	42	42
	660-690V A	6,5	8,5	8,5	8,5	17	20	20	31	40	40
	1000V A	-	-	-	-	-	-	-	-	-	-
Rated operational power of three-phase motors 50-60Hz	220-230V kW	3	4	5	6	6	8,5	11	12,5	18,5	22
	240V kW	3	4	5	7	7	9	11,5	13,5	19	23
	380-400V kW	4	5,5	7,5	11	11	15	18,5	22	30	37
	415V kW	4,5	6	8,5	12	12	16	20	24	33	40
	440V kW	4,5	6	8,5	12	12	16	20	24	33	40
	500V kW	5,5	7,5	10	10	15	18,5	18,5	30	37	45
	660-690V kW	5,5	7,5	10	10	15	18,5	18,5	30	37	45
	1000V kW	-	-	-	-	-	-	-	-	-	-
Utilization category AC4											
Switching of squirrel cage motors, inching											
Rated operational current $I_n (=I_{n0})$ open and enclosed	220V A	12	15	18	18	24	30	40	50	63	63
	230V A	11,5	14,5	18	18	24	30	40	50	62	62
	240V A	11	14	18	18	24	32	40	50	62	62
	380-400V A	10	14	18	18	24	32	40	50	62	62
	415V A	9	14	18	18	23	30	37	45	60	60
	440V A	9	14	18	18	23	30	37	45	55	55
	500V A	9	12	16	16	17,5	21	21	33	42	42
	660V A	7	9	9	9	17	20	20	31	40	40
	690V A	6,5	8,5	8,5	8,5	17	20	20	31	40	40
	1000V A	-	-	-	-	-	-	-	-	-	-

Main Contacts		Type	J7KN-10	J7KN-14	J7KN-18	J7KN-22	J7KN-24	J7KN-32	J7KN-40	J7KN-50	J7KN-62	J7KN-74
Rated operational power of three-phase motors 50-60Hz	220-230V	kW	3	4	5	5	6	8,5	11	12,5	18,5	18,5
	240V	kW	3	4	5	5	7	9	11,5	13,5	19	19
	380-400V	kW	4	5,5	7,5	7,5	11	15	18,5	22	30	30
	415V	kW	4,5	6	8,5	8,5	12	16	20	24	33	33
	440V	kW	4,5	6	8,5	8,5	12	16	20	24	33	33
	500V	kW	5,5	7,5	10	10	15	18,5	18,5	30	37	37
	660-690V	kW	5,5	7,5	10	10	15	18,5	18,5	30	37	37
1000V	kW	-	-	-	-	-	-	-	-	-	-	-
Utilization category AC 5a												
Switching of gas discharge lamps												
Rated operational current I_n per pole at 220/230V												
Fluorescent lamps,												
uncompensated and serial compensated	A	20	20	25	25	40	52	64	88	96	104	104
parallel compensated	A	7	9	9	9	18	22	22	30	40	45	45
dual-connection	A	22,5	22,5	28	28	45	58	72	98	108	117	117
Metal halide lamps ² ,												
uncompensated	A	12	15	19	19	30	39	48	66	72	78	78
parallel compensated	A	7	9	9	9	18	22	22	30	40	45	45
Mercury-vapour lamps ³ ,												
uncompensated	A	22,5	25	28	28	45	58	72	99	108	117	117
parallel compensated	A	7	9	9	9	18	22	22	30	40	45	45
Mixed light lamps ⁴	A	20	20	25	25	40	52	64	88	96	104	104
Utilization category AC5b												
Switching of incandescent lamps⁵												
Rated operational current I_n per pole at 220/230V	A	12,5	12,5	12,5	12,5	25	31	31	43	56	56	56
Utilization category AC6a												
Transformer primary switching												
at inrush	n	30	30	30	30	30	30	30	30	30	30	30
Rated operational current I_n	400V A	4,5	5,5	7,5	7,5	10,5	13,5	13,5	20	27	33	33
Rated operational power dependent on inrush n	220-230V	kVA	1,8	2,2	3	3	4,2	5,4	5,4	8	10,7	13
	240V	kVA	1,9	2,3	3,1	3,1	4,3	5,6	5,6	8,3	11,2	13,5
	380-400V	kVA	3,1	3,8	5,2	5,2	7,3	9,3	9,3	13,5	18,5	22,5
For different inrush-factors x use the following formula: $P_x = P_n \cdot (n/x)$	415-440V	kVA	3,4	4,2	5,7	5,7	8	10,2	10,2	15	20,5	25
	500V	kVA	3,9	4,8	6,5	6,5	9	11,5	11,5	17	23	28
	660-690V	kVA	5,4	6,5	9	9	12,5	16	16	24	32	39
Utilization category AC6b												
Switching of three-phase capacitor banks												
Maximum inrush current (peak value) as multiple k of the capacitor rated current	k	35	25	20	20	25	25	25	25	25	25	20
Rated operational current I_n	500V A	8	12	15,5	15,5	23	32	32	45	60	70	70
Rated operational power (sinφ→1)	220-230V	kVAr	3	4,5	6	6	8,5	12	12	17	24	28
	240V	kVAr	3,5	5	6,5	6,5	9,5	13	13	18,5	25	29
	380-400V	kVAr	5	7,5	10	10	15	20	20	29	39	46
For different multiples x use the following formula: $P_x = P_k \cdot (k/x)$	415-440V	kVAr	5,5	8	11	11	16	22	22	32	43	50
	500V	kVAr	7	10	13	13	20	26	26	39	50	58
	660-690V	kVAr	7	10	13	13	20	26	26	40	50	58
Switching of detuned capacitors												
Rated operational current I_n	690V A	8	13	18	20	28	36	42	48	72	105 ¹⁾	105 ¹⁾
Rated operational power	220-230V	kVAr	2,9	5	7	7,5	11	14	16	20	28	33
	240V	kVAr	3,1	5,4	7	8	11	14	17	20	28	36
	380-400V	kVAr	5	9	12,5	13	20	25	27,5	33,3	50	75 ¹⁾
	415-440V	kVAr	5,5	9,5	13	14	22	27	30	36	53	75 ¹⁾
	500V	kVAr	6	11	15	17	25	30	36	40	60	75
	660-690V	kVAr	8	15	20	22	33	41	48	55	82	100
Utilization category DC1												
Switching of resistive load												
Time constant L/R ≤1ms												
Rated operational current I_n	1 pole	24V A	20	25	32	32	50	65	80	110	120	130
		60V A	20	25	32	32	50	65	80	110	120	130
		110V A	6	6	6	6	10	10	10	12	12	12
		220V A	0,8	0,8	0,8	0,8	1,4	1,4	1,4	1,4	1,4	1,4
	3 poles in series	24V A	20	25	32	32	50	65	80	110	120	130
		60V A	20	25	32	32	50	65	80	110	120	130
		110V A	20	25	32	32	50	65	80	110	120	130
		220V A	16	20	20	20	30	35	35	63	80	80

Main Contacts		Type	J7KN-10	J7KN-14	J7KN-18	J7KN-22	J7KN-24	J7KN-32	J7KN-40	J7KN-50	J7KN-62	J7KN-74	
Utilization category DC3 and DC5													
Switching of shunt motors and series motors													
Time constant L/R ≤15ms													
Rated operational current I _o	1 pole/24V A	20	25	32	32	50	65	80	110	120	130		
		60V A	6	6	6	6	30	30	30	60	60	60	
		110V A	1,2	1,2	1,2	1,2	1,8	1,8	1,8	1,8	1,8	1,8	
	3 poles in series 24V A	0,2	0,2	0,2	0,2	0,2	0,2	0,2	0,2	0,25	0,25	0,25	
		20	25	32	32	50	65	80	110	120	130		
		60V A	20	25	32	32	40	40	40	80	80	80	
		110V A	20	20	20	20	40	40	40	80	80	80	
		220V A	2,5	2,5	2,5	2,5	4	4	4	5	5	5	
Maximum ambient temperature													
Operation	open °C	-40 to +60 (+90) ⁶⁾											
	enclosed °C	-40 to +40											
with thermal overload relay	open °C	-25 to +60											
	enclosed °C	-25 to +40											
Storage	°C	-50 to +90											
Short circuit protection													
for contactors without thermal overload relay													
Coordination-type "1" according to IEC 947-4-1													
Contact welding without hazard of persons													
max. fuse size	gL (gG) A	63	63	63	63	80	80	80	160	160	160		
Coordination-type "2" according to IEC 947-4-1													
Light contact welding accepted													
max. fuse size	gL (gG) A	25	35	35	35	50	50	50	100	125	125		
Contact welding not accepted													
max. fuse size	gL (gG) A	16	16	16	16	25	35	35	50	63	63		
For contactors with thermal overload relay the device with the smaller admissible backup fuse (contactor or thermal overload relay) determines the fuse size.													
Cable cross-sections													
for contactors without thermal overload relay													
main connector	solid or stranded mm ²	0,75 - 6					1,5 - 25			4 - 50			
	flexible mm ²	1 - 4					2,5 - 16			10 - 35			
	flexible with multicore cable end mm ²	0,75 - 4					1,5 - 16			6 - 35			
Cables per clamp		2					1			1			
	solid or stranded mm ²	6+(1-6) / 4+(0,75-4)					16+(2,5-6) / 10+(4-10)			50+4 / 35+6 / 25+(6-16)			
	flexible mm ²	2,5+(0,75-2,5) / 1,5+(0,75-1,5)					6+(4-6) / 4+(2,5-4)			16+(6-16) / 10+(6-16)			
Cables per clamp		6+(1,5-6) / 4+(1-4)					16+(2,5-6) / 10+(4-10)			50+(4-10) / 35+(4-16)			
		2,5+(0,75-2,5) / 1,5+(0,75-1,5)					6+(4-6) / 4+(2,5-4)			25+(4-25) / 16+(4-16)			
		2					2			2			
main connector	solid AWG	18 - 10					16 - 10			12 - 10			
	flexible AWG	18 - 10					14 - 4			10 - 0			
		2					1			1			
Cables per clamp	solid AWG	10+(16-10) / 12+(18-12)					10+(16-10) / 12+(18-12)			10+(12-10) / 12+12			
	flexible AWG	14+(18-14) / 16+(18-16)					14+(18-14) / 16+(18-16)			1+(12-10) / 2+(8-12)			
		10+(14-10) / 12+(18-12)					4+(18-12) / 6+(18-8)			3+(12-8) / 4+(10-6)			
Cables per clamp		14+(18-14) / 16+(18-16)					8+(18-8) / 10+(18-12)			2			
		2					2			2			
Frequency of operations z													
Contactors without thermal overload relay													
	without load 1/h	10000	10000	10000	10000	7000	7000	7000	7000	7000	7000		
	AC3, I _o 1/h	600	600	600	600	600	600	600	400	400	400		
	AC4, I _o 1/h	120	120	120	120	120	120	120	120	120	120		
	DC3, I _o 1/h	600	600	600	600	600	600	600	400	400	400		
Mechanical life													
AC operated	S x 10 ⁶	10	10	10	10	10	10	10	10	10	10		
DC operated	S x 10 ⁶	10	10	10	10	10	10	10	10	10	10		
Short time current													
	10s-current A	96	120	144	176	184	240	296	360	504	592		
Power loss per pole													
	at I _o /AC3 400V W	0,21	0,35	0,5	0,75	0,7	1,3	2	2,2	3,9	5,5		
Resistance to shock acc. to IEC 68-2-27													
Shock time 20ms sine-wave	NO g	10	10	10	10	8	8	8	8	8	8		
	NC g	6	6	6	6	-	-	-	-	-	-		

*1) Suitable at 690V for: earthed-neutral systems, overvoltage I to IV, pollution degree 3 (standard-industry): U_{imp} = 8kV.

Data for other conditions on request.

*2) Metal halide lamps and sodium-vapour lamps (high- and low-pressure lamps)

*3) High-pressure lamps

*4) Blended lamps, containing a mercury high-pressure unit and a tungsten helix in a fluorescent glass bulb (daylight lamps)

*5) Current inrush approx. 16 x I_o

*6) With reduced control voltage range 0,9 up to 1,0 x U_s and with reduced rated current I_o/AC1 according to I_o/AC3

Main Contacts		Type	J7KN-85	J7KN-110	J7KN-150	J7KN-175	J7KN-200
Rated insulation voltage U_i ¹⁾		V AC	750	750	690	690	690
Making capacity I_{mk}		at $U_c = 690V$ AC A	1100	1200	1500	1800	1700
Breaking capacity I_{br}		400V AC A	950	1100	1200	1400	1600
J7KN-10 to J7KN-22 $\cos\phi = 0,65$		500V AC A	850	1000	1200	1400	1600
J7KN-24 to J7KN-72 $\cos\phi = 0,35$		690V AC A	600	600	700	800	1200
		1000V AC A	-	-	-	-	-
Utilization category AC1							
Switching of resistive load							
Rated operational current $I_e (=I_{th})$ at 40°C, open		A	150	170	200	250	350
Rated operational power of three-phase resistive loads 50-60Hz, $\cos\phi = 1$		220V kW	57	64	72	90	125
		230V kW	59	67	72	90	125
		240V kW	62	70	75	94	130
		380V kW	98	111	125	156	218
		400V kW	103	117	125	156	218
		415V kW	107	122	130	160	225
		440V kW	114	129	144	180	250
		500V kW	130	147	164	205	285
		660V kW	171	194	216	270	380
		690V kW	179	203	216	270	380
		1000V kW	-	-	-	-	-
Rated operational current $I_e (=I_{th})$ at 60°C, enclosed		A	100	125	160	200	280
Rated operational power of three-phase resistive loads 50-60Hz, $\cos\phi = 1$		220V kW	38	47	60	76	106
		230V kW	40	49	63	79	111
		240V kW	41	52	66	83	116
		380V kW	65	82	105	131	184
		400V kW	69	86	110	138	193
		415V kW	71	89	115	143	201
		440V kW	71	95	121	152	213
		500V kW	86	108	138	173	242
		660V kW	114	142	182	228	320
		690V kW	119	149	191	239	334
		1000V kW	-	-	-	-	-
Minimum cross-section of conductor at load with $I_e (=I_{th})$		mm ²	50	70	95	120	185
Utilization category AC2 and AC3							
Switching of three-phase motors							
Rated operational current I_e open and enclosed		220V A	85	110	150	175	210
		230V A	85	110	150	175	210
		240V A	85	110	150	175	210
		380-400V A	85	110	150	175	210
		415V A	85	110	150	175	210
		440V A	85	110	-	-	-
		500V A	60	60	-	-	-
		660-690V A	57,5	57,5	-	-	-
		1000V A	-	-	-	-	-
Rated operational power of three-phase motors 50-60Hz		220-230V kW	25	33	40	50	60
		240V kW	27	35	45	55	65
		380-400V kW	45	55	75	90	110
		415V kW	49	63	80	95	115
		440V kW	49	63	85	100	125
		500V kW	55	75	75	100	132
		660-690V kW	55	55	75	110	132
		1000V kW	-	-	-	-	-
Utilization category AC4							
Switching of squirrel cage motors, inching							
Rated operational current $I_e (=I_{th})$ open and enclosed		220V A	85	98	55	63	85
		230V A	85	98	55	63	85
		240V A	85	98	55	63	85
		380-400V A	85	85	55	63	85
		415V A	85	85	-	-	-
		440V A	85	85	-	-	-
		500V A	85	85	-	-	-
		660V A	60	60	-	-	-
		690V A	57,5	57,5	-	-	-
		1000V A	-	-	-	-	-

Main Contacts		Type	J7KN-85	J7KN-110	J7KN-150	J7KN-175	J7KN-200
Rated operational power of three-phase motors 50-60Hz	220-230V	kW	25	30	15	18,5	25
	240V	kW	27	32	15,5	19	26
	380-400V	kW	45	45	25	30	45
	415V	kW	49	49	25	33	45
	440V	kW	49	49	30	34	48
	500V	kW	55	55	25	30	55
	660-690V	kW	55	55	25	30	55
	1000V	kW	-	-	-	-	-
Utilization category AC 5a							
Switching of gas discharge lamps							
Rated operational current I _o per pole at 220/230V							
Fluorescent lamps,							
uncompensated and serial compensated	A	100	120	120	140	180	180
parallel compensated	A	55	70	85	100	120	120
dual-connection	A	112	144	120	140	180	180
Metal halide lamps ² ,							
uncompensated	A	85	90	95	110	140	140
parallel compensated	A	55	70	75	85	110	110
Mercury-vapour lamps ³ ,							
uncompensated	A	112	144	120	140	180	180
parallel compensated	A	55	70	75	85	110	110
Mixed light lamps ⁴							
	A	100	120	100	120	160	160
Utilization category AC5b							
Switching of incandescent lamps⁵							
Rated operational current I _o per pole at 220/230V	A	69	75	100	120	160	160
Utilization category AC6a							
Transformer primary switching							
at inrush	n	30	30	30	30	30	30
Rated operational current I _o	400V A	38	50	65	80	90	90
Rated operational power dependent on inrush n	220-230V	kVA	15	20	25	30	34
	240V	kVA	15,5	20,5	27	33	37
	380-400V	kVA	26	34	45	55	60
For different inrush-factors x use the following formula: Px=Pn*(n/x)	415-440V	kVA	29	38	46	57	63
	500V	kVA	33	43	55	69	75
	660-690V	kVA	45	60	56	69	100
Utilization category AC6b							
Switching of three-phase capacitor banks							
Maximum inrush current (peak value) as multiple k of the capacitor rated current	k	20	20	20	20	15	15
Rated operational current I _o	500V A	87	100	120	155	195	195
Rated operational power (sinφ→1)	220-230V	kVAr	33	38	45	60	75
	240V	kVAr	36	42	52	62	78
	380-400V	kVAr	57	65	80	100	130
For different multiples x use the following formula: Px=Pk*(k/x)	415-440V	kVAr	60	70	95	110	135
	500V	kVAr	70	80	100	130	170
	660-690V	kVAr	70	80	100	130	170
Switching of detuned capacitors							
Rated operational current I _o	690V A	98	105	115	140	200	200
Rated operational power	220-230V	kVAr	35	40	43	53	76
	240V	kVAr	39	43	45	55	80
	380-400V	kVAr	68	75	75	90	130
	415-440V	kVAr	71	77	80	100	140
	500V	kVAr	85	90	95	120	170
	660-690V	kVAr	110	120	125	150	200
Utilization category DC1							
Switching of resistive load							
Time constant L/R ≤1ms							
Rated operational current I _o	1 pole 24V A	60V A	150	170	-	-	-
		110V A	20	25	-	-	-
		220V A	2	2,5	-	-	-
		3 poles in series 24V A	150	170	200	250	350
	60V A	110V A	150	170	200	250	350
		110V A	150	170	150	170	250
		220V A	100	160	80	100	150

Main Contacts		Type	J7KN-85	J7KN-110	J7KN-150	J7KN-175	J7KN-200
Utilization category DC3 and DC5							
Switching of shunt motors and series motors							
Time constant L/R ≤15ms							
Rated operational current I _o	1 pole 24V A	60V A	150	170	-	-	-
		110V A	85	110	-	-	-
		220V A	2	2,5	-	-	-
		220V A	0,5	0,5	-	-	-
	3 poles in series 24V A	60V A	150	170	-	-	-
		110V A	100	110	-	-	-
		110V A	100	110	-	-	-
		220V A	7	8	-	-	-
Maximum ambient temperature							
Operation	open °C	-40 to +60 (+90) ⁶			-25 to +55 (+70) ⁷		
	enclosed °C	-40 to +40			-25 to +40		
with thermal overload relay	open °C	-25 to +60			-25 to +55		
	enclosed °C	-25 to +40			-25 to +40		
Storage	°C	-50 to +90			-55 to +80		
Short circuit protection							
for contactors without thermal overload relay							
Coordination-type "1" according to IEC 947-4-1							
Contact welding without hazard of persons							
max. fuse size	gL (gG) A	250	250	250	315	400	
Coordination-type "2" according to IEC 947-4-1							
Light contact welding accepted							
max. fuse size	gL (gG) A	160	200	200	250	315	
Contact welding not accepted							
max. fuse size	gL (gG) A	100	125	160	200	250	
For contactors with thermal overload relay the device with the smaller admissible backup fuse (contactor or thermal overload relay) determines the fuse size.							
Cable cross-sections							
for contactors without thermal overload relay							
main connector	solid or stranded mm ²	10 - 70 ⁸	10 - 70 ⁸	95	120	185	
	flexible mm ²	6 - 50 ⁸	16 - 50 ⁸	screw	screw	screw	
	flexible with multicore cable end mm ²	10 - 35	10 - 35	M8	M8	M8	
Cables per clamp	solid or stranded mm ²						
	flexible mm ²						
main connector	solid AWG	10	10				
	flexible AWG	6 - 0	6 - 0				
Cables per clamp	solid AWG	1	1				
	flexible AWG						
Frequency of operations z							
Contactors without thermal overload relay							
	without load 1/h	3000	3000	1200	1200	1200	
	AC3, I _e 1/h	300	300	-	-	-	
	AC4, I _e 1/h	120	120	-	-	-	
	DC3, I _e 1/h	300	300	-	-	-	
Mechanical life							
AC operated	S x 10 ⁶	5	5	10	10	8	
DC operated	S x 10 ⁶	5	5	10	10	8	
Short time current		10s-current A	680	880	1200	1400	1800
Power loss per pole		at I _o /AC3 400V W	4,3	6,0	8	11	8
Resistance to shock acc. to IEC 68-2-27							
Shock time 20ms sine-wave	NO g	7	7	-	-	-	
	NC g	5	5	-	-	-	

- *1) Suitable at 690V for: earthed-neutral systems, overvoltage I to IV, pollution degree 3 (standard-industry): U_{imp} = 8kV. Data for other conditions on request.
- *2) Metal halide lamps and sodium-vapour lamps (high- and low-pressure lamps)
- *3) High-pressure lamps
- *4) Blended lamps, containing a mercury high-pressure unit and a tungsten helix in a fluorescent glass bulb (daylight lamps)
- *5) Current inrush approx. 16 x I_o
- *6) With reduced control voltage range 0,9 up to 1,0 x U_s and with reduced rated current I_o/AC1 according to I_o/AC3
- *7) With reduced control voltage range 1,0 x U_s and with reduced rated current I_o/AC1 according to I_o/AC3
- *8) Maximum cable cross-section with prepared conductor

LVSG

Contactors

Data according to IEC 947-4-1, EN 60947-4-1, VDE 0660

Auxiliary Contacts	Type	J7KN-10	J7KN-14	J7KN-18	J7KN-22	J7KN-24	J7KN-32	J7KN-40	J7KN-50	J7KN-62	J7KN-74
Rated insulation voltage U_i^{*1}	V~	690	690	690	690	-	-	-	-	-	-
Thermal rated current I_n to 690V											
Ambient temperature	40°C A	16	16	16	16	-	-	-	-	-	-
	60°C A	12	12	12	12	-	-	-	-	-	-
Utilization category AC15											
Rated operational current I_n	220-240V A	12	12	12	12	-	-	-	-	-	-
	380-415V A	4	4	4	4	-	-	-	-	-	-
	440V A	4	4	4	4	-	-	-	-	-	-
	500V A	3	3	3	3	-	-	-	-	-	-
	660-690V A	1	1	1	1	-	-	-	-	-	-
Utilization category DC13											
Rated operational current I_n	60V A	8	8	8	8	-	-	-	-	-	-
	110V A	1	1	1	1	-	-	-	-	-	-
	220V A	0,1	0,1	0,1	0,1	-	-	-	-	-	-
Short circuit protection											
short-circuit current 1kA, contact welding not accepted											
max. fuse size	gL (gG) A	25	25	25	25	-	-	-	-	-	-
For contactors with thermal overload relay the device with the smaller admissible control fuse (contactor or thermal overload relay) determines the fuse.											
Control Circuit											
Power consumption of coils											
AC operated	inrush VA	33-45				90-115			140-165		
	sealed VA	7-10				9-13			13-18		
	W	2,6-3				2,7-4			5,4-7		
DC operated	inrush W	75				140			200		
	sealed W	2				2			6		
Operation range of coils											
in multiples of control voltage U_c	AC operated	0,85-1,1				0,85-1,1			0,85-1,1		
	DC operated	0,8-1,1				0,8-1,1			0,8-1,1		
Switching time at control voltage $U_c \pm 10\%^{*2,*3}$											
AC operated	make time ms	8-16				10-25			12-28		
	release time ms	5-13				8-15			8-15		
	arc duration ms	10-15				10-15			10-15		
DC operated	make time ms	8-12				10-20			12-23		
	release time ms	8-13				10-15			10-18		
	arc duration ms	10-15				10-15			10-15		
Cable cross-section											
Auxiliary connector	solid mm ²	0,75-6				-			-		
	flexible mm ²	1-4				-			-		
flexible with multicore cable end	mm ²	0,75-4				-			-		
Magnet coil	solid mm ²	0,75-2,5				0,75-2,5			0,75-2,5		
	flexible mm ²	0,5-2,5				0,5-2,5			0,5-2,5		
	flexible with multicore cable end mm ²	0,5-1,5				0,5-1,5			0,5-1,5		
Clamps per pole		2				2			2		
Auxiliary connector	solid AWG	18 - 10				-			-		
	flexible AWG	18 - 10				-			-		
Magnet coil	solid AWG	14 - 12				14 - 12			14 - 12		
	flexible AWG	18 - 12				18 - 12			18 - 12		
Clamps per pole		2				2			2		

*1) Suitable for: earthed-neutral systems, overvoltage category I to IV, pollution degree 3 (standard-industry): $U_{imp} = 8kV$. Data for other conditions on request

*2) Total breaking time = release time + arc duration

*3) Values for delay of the release time of the making contact and the make time of the break contact will be increased, if magnet coils are protected against voltage peaks (varistor, RC-unit, diode-unit)

Auxiliary Contacts		Type	J7KN-85	J7KN-110	J7KN-150	J7KN-175	J7KN-200
Rated insulation voltage U_i^{*1}		V~	690	690	690	690	690
Thermal rated current I_n to 690V							
Ambient temperature		40°C A	16	16	10	10	10
		60°C A	12	12	-	-	-
Utilization category AC15							
Rated operational current I_n		220-240V A	12	12	3	3	3
		380-415V A	6	6	2	2	2
		440V A	6	6	1,5	1,5	1,5
		500V A	4	4	1,5	1,5	1,5
		660-690V A	2	2	1	1	1
Utilization category DC13							
Rated operational current I_n		60V A	8	8	-	-	-
		110V A	1	1	0,5	0,5	1
		220V A	0,1	0,1	0,2	0,2	0,5
Short circuit protection							
short-circuit current 1kA, contact welding not accepted							
max. fuse size		gL (gG) A	25	25	10	10	10
For contactors with thermal overload relay the device with the smaller admissible control fuse (contactor or thermal overload relay) determines the fuse.							
Control Circuit							
Power consumption of coils							
AC operated		inrush VA	280-350	350-420	550	550	1100
		sealed VA	16 -23	23 -29	120	120	66
		W	4-6	6-7,3	-	-	-
DC operated		inrush W	170	320	160	160	530
		sealed W	2	4	5	5	21
Operation range of coils							
in multiples of control voltage U_c		AC operated	0,85-1,1		0,85-1,1	0,85-1,1	0,85-1,1
		DC operated	0,8-1,1		0,85-1,1	0,85-1,1	0,85-1,1
Switching time at control voltage $U_c \pm 10\%^{*2, *3}$							
AC operated		make time ms	13-30		12-30	12-30	30-40
		release time ms	8-15		15-40	15-40	15-45
		arc duration ms	10-15		-	-	-
DC operated		make time ms	20-30		-	-	-
		release time ms	10-18		-	-	-
		arc duration ms	10-15		-	-	-
Cable cross-section							
Auxiliary connector		solid mm ²	0,75-2,5		0,75-2,5		
		flexible mm ²	0,75-2,5		0,75-2,5		
flexible with multicore cable end		mm ²	0,5-1,5		-		
Magnet coil		solid mm ²	0,75-2,5		1-2,5		
		flexible mm ²	0,5-2,5		1-2,5		
		flexible with multicore cable end mm ²	0,5-1,5		-		
Clamps per pole			14 - 12		16 - 12		
Auxiliary connector		solid AWG	18 - 12		16 - 12		
		flexible AWG	14 - 12		16 - 12		
Magnet coil		solid AWG	18 - 12		16 - 12		
		flexible AWG	2		2		
Clamps per pole			0,75-2,5		0,75-2,5		

*1) Suitable for: earthed-neutral systems, overvoltage category I to IV, pollution degree 3 (standard-industry): $U_{imp} = 8kV$. Data for other conditions on request

*2) Total breaking time = release time + arc duration

*3) Values for delay of the release time of the making contact and the make time of the break contact will be increased, if magnet coils are protected against voltage peaks (varistor, RC-unit, diode-unit)

Contactors for North America

Data according to UL508

Main Contacts (cULus)	Type	J7KN-10	J7KN-14	J7KN-18	J7KN-22	J7KN-24	J7KN-32	J7KN-40	J7KN-50	J7KN-62	J7KN-74
Rated operational current "General Use"	A	25	25	30	30	50	65	80	110	120	130
Rated operational power of three-phase motors at 60Hz (3ph)	110-120V hp	1½	2	2	3	5	5	7½	10	10	10
	200V hp	3	3	5	5	7½	10	10	15	20	25
	220-240V hp	3	3	7½	7½	10	10	15	20	25	30
	277V hp	3	5	7½	7½	10	10	15	20	25	30
	380-415V hp	5	5	10	10	10	15	20	25	30	40
	440-480V hp	5	7½	10	15	15	20	25	30	40	50
	550-600V hp	7½	10	15	20	20	25	30	40	50	50
Rated operational power of AC motors at 60Hz (1ph)	110-120V hp	½	¾	1	1½	1½	2	3	3	5	7½
	200V hp	1	1,5	2	3	3	5	7½	7½	10	15
	220-240V hp	1½	2	3	3	5	5	7½	10	15	15
	277V hp	2	3	3	5	5	7½	10	10	15	15
	380-415V hp	3	3	5	5	5	7½	10	15	20	20
	440-480V hp	3	5	5	7½	7½	10	15	20	25	25
	550-600V hp	3	5	7½	10	10	15	20	25	30	30
Rated operational power of three-phase motors at 60Hz (3ph) for elevators	110-120V hp	-	-	-	-	2	3	-	3	5	-
	200V hp	-	-	-	-	3	5	-	7½	10	-
	220-240V hp	-	-	-	-	5	7½	-	7½	10	-
Demands according to ANSI A17.5 (500.000 operations)	440-480V hp	-	-	-	-	10	15	-	20	25	-
	550-600V hp	-	-	-	-	10	20	-	25	30	-
Rated operational current	600V A	-	-	-	-	15	22	-	27	37	-
Fuses	A	30	40	50	50	90	125	175	175	225	250
Suitable for use on a capability of delivering not more than	rms A	5000	5000	5000	5000	5000	5000	5000	5000	5000	5000
	V	600	600	600	600	600	600	600	600	600	600
Auxiliary Contacts (cULus)		A600	A600	A600	A600	-	-	-	-	-	-

Main Contacts (cULus)	Type	J7KN-85	J7KN-110	J7KN-150	J7KN-175	J7KN-200
Rated operational current "General Use"	A	125	125	-	-	-
Rated operational power of three-phase motors at 60Hz (3ph)	110-120V hp	15	-	-	-	-
	200V hp	-	30	-	-	-
	220-240V hp	35	40	-	-	-
	277V hp	-	-	-	-	-
	380-415V hp	-	-	-	-	-
	440-480V hp	65	75	-	-	-
	550-600V hp	85	100	-	-	-
Rated operational power of AC motors at 60Hz (1ph)	110-120V hp	8	10	-	-	-
	200V hp	-	20	-	-	-
	220-240V hp	20	20	-	-	-
	277V hp	-	-	-	-	-
	380-415V hp	-	-	-	-	-
	440-480V hp	-	50	-	-	-
	550-600V hp	-	60	-	-	-
Rated operational power of three-phase motors at 60Hz (3ph) for elevators	110-120V hp	-	-	-	-	-
	200V hp	-	-	-	-	-
	220-240V hp	-	-	-	-	-
Demands according to ANSI A17.5 (500.000 operations)	440-480V hp	-	-	-	-	-
	550-600V hp	-	-	-	-	-
Rated operational current	600V A	-	62	-	-	-
Fuses	A	-	300	-	-	-
Suitable for use on a capability of delivering not more than	rms A	10000	10000	-	-	-
	V	600	600	-	-	-
Auxiliary Contacts (cULus)		A600	A600	-	-	-

Contactors

Data according to IEC 947-4-1, EN 60947-4-1, VDE 0660

Contact Life

For selection of the suitable contactor-type according to supply voltage, power rating and application (utilization category AC1, AC3 or AC4) use contact life characteristic diagram.

For the most common supply voltages four scales of power ratings P_n are provided for each utilization category.

Select contactor-type according to utilization category **AC3** (breaking current $I_a = I_n$) using the **motor rating** scales to the right, according to utilization category **AC4** (breaking current $I_a = 6 \times I_n$) using the **motor rating** scales to the left.*1

Select contactor-type according to utilization category **AC1** (breaking current $I_a = I_n/AC1$) using the **breaking current** scale.*1

For contactors frequently used under AC3/AC4-mixed service conditions calculate contact life with the formula:

$$M = \frac{AC3}{1 + \frac{\%AC4}{100} \times \left(\frac{AC3}{AC4} - 1 \right)}$$

M = Contact life (switching cycles) for AC3/AC4-mixed operations

AC3 = Contact life (switching cycles) for AC3 operations (normal switching conditions). Breaking current $I_a =$ rated motor current I_n .

AC4 = Contact life (switching cycles) for AC4 operations (inching).

Breaking current $I_a =$ multiples of rated motor current I_n .

%AC4 = Percents of AC4-operations related to the total cycles.

1. Pay attention to the approved rated values of the selected contactor according to the national approvals

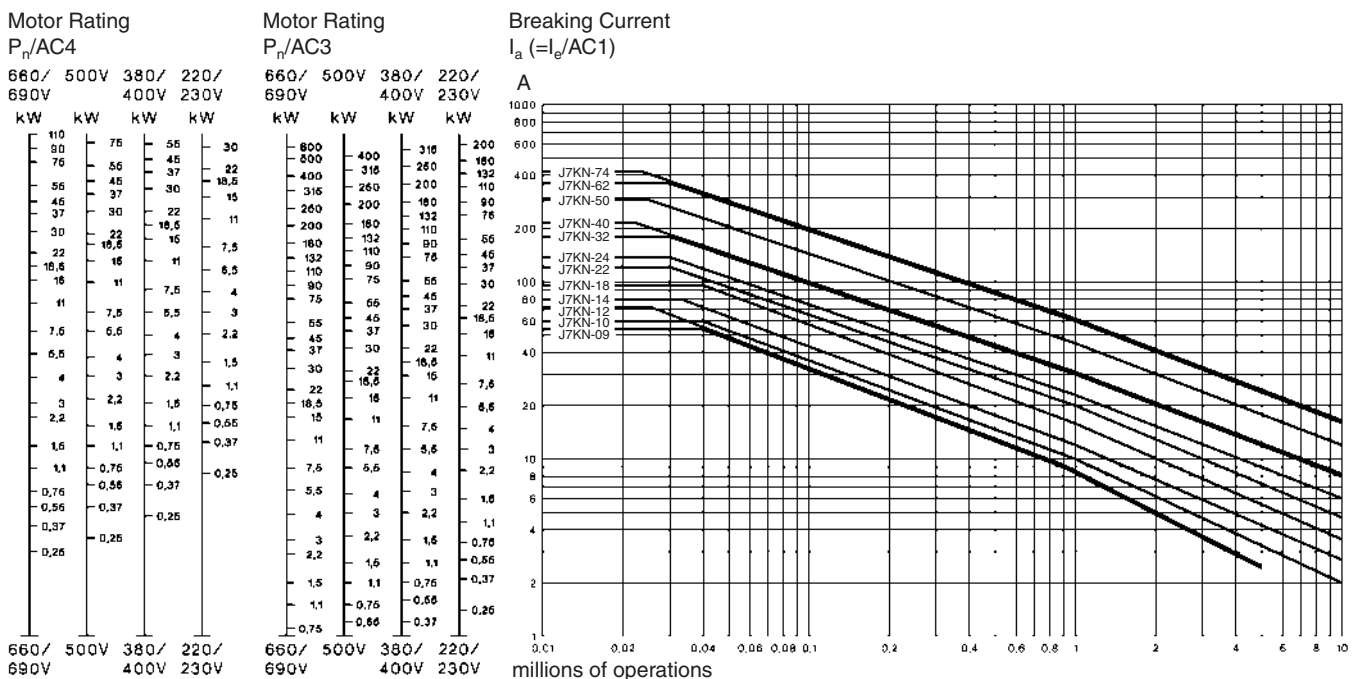

LVSG

Motor Rating
P_n/AC4

660/ 500V 380/ 220/
690V 400V 230V
kW kW kW kW

800	400	318	200
600	315	250	132
400	250	200	110
318	200	160	90
260	160	132	75
200	132	110	55
180	110	90	45
132	90	75	37
110	75	55	30
90	55	45	22
75	45	37	18,5
55	37	30	15
46	30	22	11
37	22	16,5	7,5
30	16,5	15	6,5
22	15	11	4
16,5	11	7,5	3
16	7,5	6,5	2,2
11	6,5	4	1,6
7,5	4	3	1,1
5,5	3	2,2	0,75
4	2,2	1,6	0,58
3	1,6	1,1	0,58
2,2	1,1	0,75	0,37
1,5	0,75		

Motor Rating
P_n/AC3

660/ 500V 380/ 220/
690V 400V 230V
kW kW kW kW

800	400	315	200
600	315	250	132
400	250	200	110
315	200	160	90
250	160	132	75
200	132	110	55
160	110	90	45
132	90	75	37
110	75	55	30
90	55	45	22
75	45	37	18,5
55	37	30	15
45	30	22	11
37	22	16,5	7,5
30	16,5	15	6,5
22	15	11	4
16,5	11	7,5	3
16	7,5	6,5	2,2
11	6,5	4	1,6
7,5	4	3	1,1
5,5	3	2,2	0,75
4	2,2	1,6	0,58
3	1,6	1,1	0,58
2,2	1,1	0,75	0,37
1,5	0,75		

Breaking Current
I_a (=I_g/AC1)

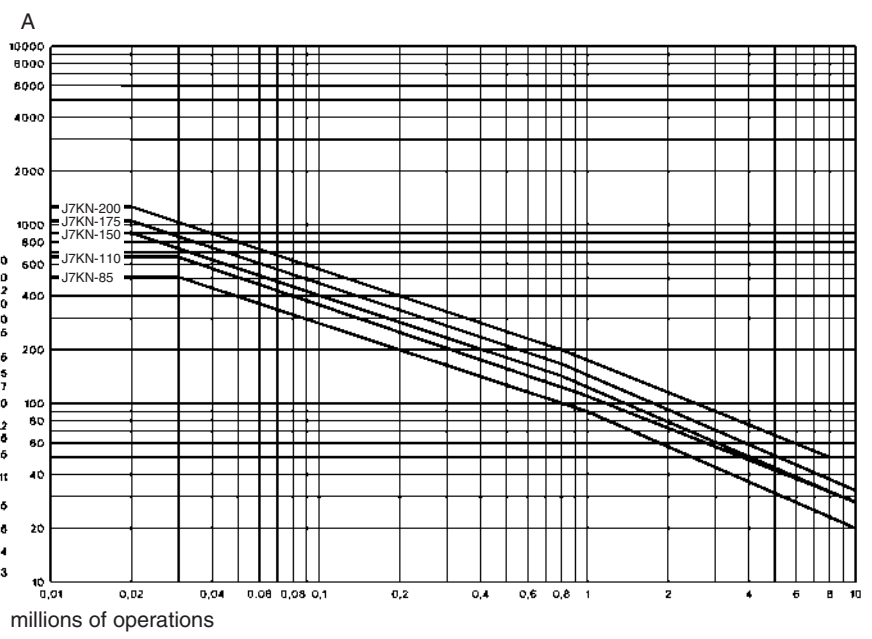

Contactors

Utilization Categories

For easier choice of devices and in order to make the comparison of different products simpler are utilization categories for contactors and motor-starters according to IEC 947-4-1 and VDE 0660 Part 102 ,for

control circuit devices and switching elements according to IEC 947-5-1 and VDE 0660 Part 200 determind. The table offers different utilization categories, typical applications and assorted test conditions.

Type of current	Category	Typical applications	Rated operational current	Test conditions for the number of on-load operating cycles						Test conditions for making and breaking capacities					
				Make I/le	U/Ue	cosφ	Break Ic/le	Ur/Ue	cosφ	Make I/le	U/Ue	cosφ	Break Ic/le	Ur/Ue	cosφ
Alternating Current	AC1	Non-inductive or slightly inductive loads-resistance furnaces	all values	1	1	0.95	1	1	0.95	1.5	1.05	0.8	1.5	1.05	0.8
	AC2	Slip-ring motors: starting, switching off	all values	2.5	1	0.65	2.5	1	0.65	4	1.05	0.65	4	1.05	0.65
	AC3	Squirrel-cage motors: starting, switching off motors during running	17A< Ie≤ 17A	6	1	0.65	1	0.17	0.65	10	1.05	0.45	8	1.05	0.45
			Ie≤ 100A	6	1	0.35	1	0.17	0.35	10	1.05	0.45	8	1.05	0.45
			Ie> 100A	6	1	0.35	1	0.17	0.35	10	1.05	0.35	8	1.05	0.35
	AC4	Squirrel-cage motors: starting, plugging, inching	17A< Ie≤ 17A	6	1	0.65	6	1	0.65	12	1.05	0.45	10	1.05	0.45
			Ie≤ 100A	6	1	0.35	6	1	0.35	12	1.05	0.45	10	1.05	0.45
			Ie> 100A	6	1	0.35	6	1	0.35	12	1.05	0.35	10	1.05	0.35
	AC5a	Switching of electric discharge lamp controls	all values	-	-	-	-	-	-	3	1.05	0.45	3	1.05	0.45
	AC5b	Switching of incandescent lamps	all values	-	-	-	-	-	-	1.5	1.05	1)	4	1.05	1)
	AC6a	Switching of transformers	Ie≤ 100A	-	-	-	-	-	-	4.5	1.05	0.45	3.6	1.05	0.45
			Ie> 100A	-	-	-	-	-	-	4.5	1.05	0.35	3.6	1.05	0.35
	AC6b	Switching of capacitor banks	-	-	-	-	-	-	-	2)			2)		
	AC7a	Slightly inductive loads in household appliances and similar applications	all values	-	-	-	-	-	-	1.5	1.05	0.8	1.5	1.05	0.8
	AC7b	Motor loadsfor household applications	Ie≤ 100A	-	-	-	-	-	-	8	1.05	0.45	6	1.05	0.45
Ie> 100A			-	-	-	-	-	-	8	1.05	0.35	6	1.05	0.35	
AC8a	Hermetic refrigerant compressor motor control with manualresetting of overload releases	Ie≤ 100A	-	-	-	-	-	-	6	1.05	0.45	6	1.05	0.45	
		Ie> 100A	-	-	-	-	-	-	6	1.05	0.35	6	1.05	0.35	
AC8b	Hermetic refrigerant compressor motor control with automatic resetting of overload releases	Ie≤ 100A	-	-	-	-	-	-	6	1.05	0.45	6	1.05	0.45	
		Ie> 100A	-	-	-	-	-	-	6	1.05	0.35	6	1.05	0.35	
AC12	Control of resistive loads and solid state loads with isolation by opto couplers	all values	-	-	-	-	-	-	1	1	0.9	1	1	0.9	
AC13	Control of solid state loads with transformer isolation	all values	-	-	-	-	-	-	10	1.1	0.65	1.1	1.1	0.65	
AC14	Control of small electromagnetic loads (<=72VA)	-	-	-	-	-	-	-	6	1.1	0.7	6	1.1	0.7	
AC15	Control of electromagnetic load (>72VA)	-	10	1	0.7	1	1	0.4	10	1.1	0.3	10	1.1	0.3	
				Make I/le	U/Ue	L/R [ms]	Break Ic/le	Ur/Ue	L/R [ms]	Make I/le	U/Ue	L/R [ms]	Break Ic/le	Ur/Ue	L/R [ms]
Direct Current	DC1	Non-inductive or slightly inductive loads resistance furnaces	all values	1	1	1	1	1	1	1.5	1.05	1	1.5	1.05	1
	DC3	Shunt-motors: starting, plugging, inching dynamic braking of d.c. motors	all values	2.5	1	2	2.5	1	2	4	1.05	2.5	4	1.05	2.5
	DC5	Series-motors: starting, plugging, inching dynamic braking of d.c. motors	all values	2.5	1	7.5	2.5	1	7.5	4	1.05	15	4	1.05	15
	DC6	Switching of incandescent lamps	all values	-	-	-	-	-	-	1.5	1.05	1)	4	1.05	1)
	DC12	Control of resistive loads and solid state loads with isolation by opto couplers	all values	-	-	-	-	-	-	1	1	1	1	1	1
	DC13	Control of electromagnets	all values	1	1	≤300	1	1	≤300	1.1	1.1	≤300	1.1	1.1	≤300
	DC14	Control of electromagnetic loads having economy resistors in circuit	all values	-	-	-	-	-	-	10	1.1	15	10	1.1	15

U_e Rated operational voltage, U Voltage before make, U_r Recovery voltage, I_e Rated operational current, I_m Current make, I_b Current broken

- 1) Test with incandescent lamps
- 2) Test conditions according to standard

LVSG

Accessories

Data according to IEC 947-5-1, EN 60947-5-1, VDE 0660

Auxiliary Contacts	Type	J73KN-B	J73KN-C	J73KN-B-TP...
Rated insulation voltage U_i^{*1}	V~	690	690	690
Thermal rated current I_n to 690V				
Ambient temperature	40°C A	10	10	10
	60°C A	6	6	-
Frequency of operations z	1/h	3000	3000	1200
Mechanical life	S x 10^6	10	10	1
Power loss per pole at $I_n/AC1$	W	0,5	0,5	-
Utilization category AC15				
Rated operational current I_n	220-240V A	3	3	4
	380-400V A	2	2	3
	440V A	1,6	1,6	2
	500V A	1,2	1,2	2
	660-690V A	0,6	0,6	2
Utilization category DC13				
Rated operational current I_n	60V A	2	2	2,5
	110V A	0,4	0,4	1,5
	220V A	0,1	0,1	0,2
Short circuit protection				
short-circuit current 1kA, contact welding not accepted max. fuse size	gL (gG) A	20	20	10
For contactors with thermal overload relay or auxiliary contacts the device with the smaller admissible control fuse (contactor or thermal overload relay) determines the fuse size.				
Cable cross-sections				
	solid or stranded mm ²	0,75-2,5	0,75-2,5	1-2,5
	flexible mm ²	0,75-2,5	0,75-2,5	0,75-2,5
	flexible with multicore cable end mm ²	0,5-1,5	0,5-1,5	0,75-2,5
Cables per clamp		2	2	2

*1) Suitable for: earthed-neutral systems, overvoltage category I to IV, pollution degree 3 (standard-industry): $U_{imp} = 8kV$. Data for other conditions on request

Data according to CSA, UL and CUL

Auxiliary Contacts	Type	J73KN-B	J73KN-C	J73KN-B-TP...
Rated operational current „General Use“	A	10	10	10
Rated operational voltage	max. V AC	600	600	600
Auxiliary Contacts		A600	A600	A600

Contactors and Accessories

Wiring diagrams

Auxiliary contact blocks

J73KN-B-10

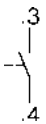

J73KN-B-01

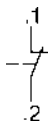

J73KN-C-11S*1

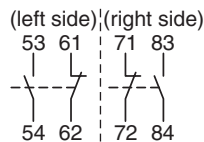

Pneumatic timer

on-delayed

J74KN-B-TP...DA

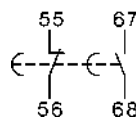

off-delayed

J74KN-B-TP...IA

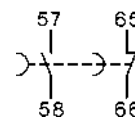

*1) Correct terminal marking is given by mounting

■ Dimensions

AC operated

J7KN-10...
 J7KN-10-4
 J7KN-14...
 J7KN-18...
 J7KN-22...

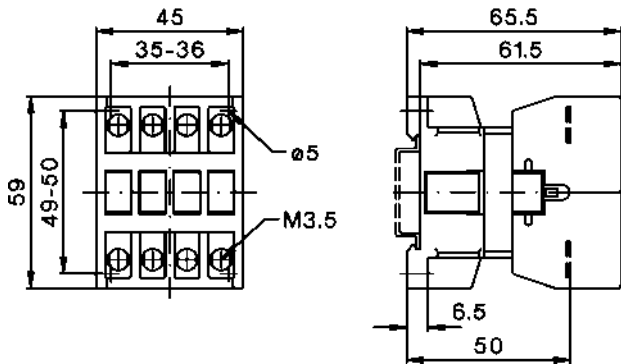

J7KN-24...
 J7KN-32...
 J7KN-40...

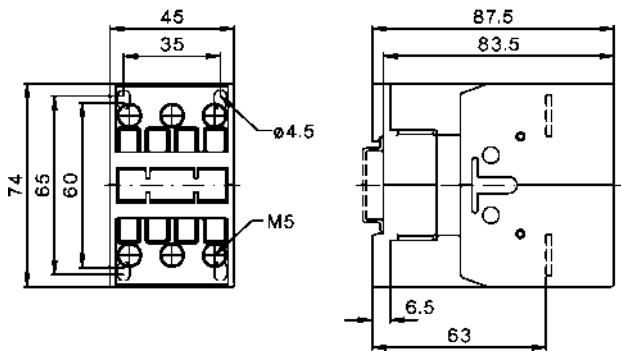

J7KN-50...
 J7KN-62...
 J7KN-74...

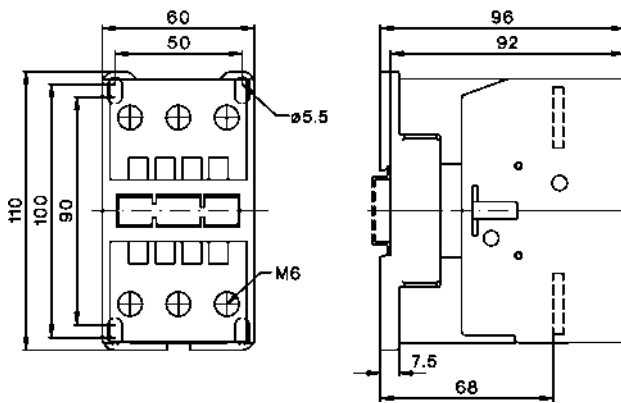

DC operated

J7KN-10...D
 J7KN-14...D
 J7KN-18...D
 J7KN-22...D

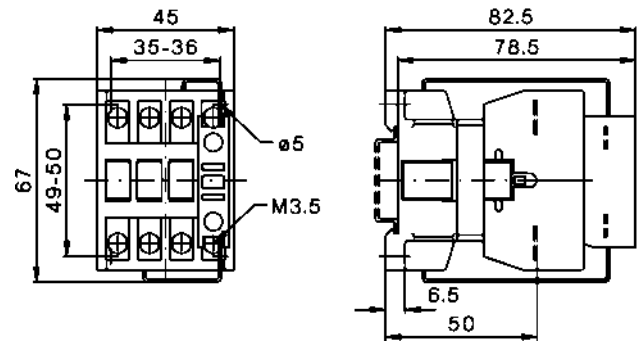

J7KN-24...D
 J7KN-32...D
 J7KN-40...D

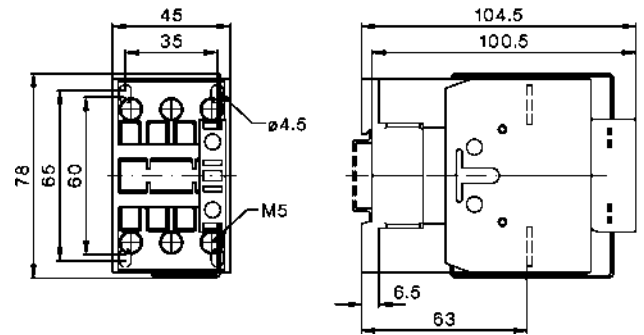

J7KN-50...D
 J7KN-62...D
 J7KN-74...D

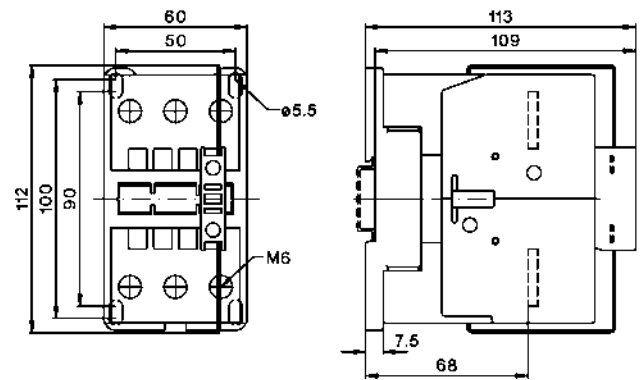

LVSG

AC operated

J7KN-85...
J7KN-110...

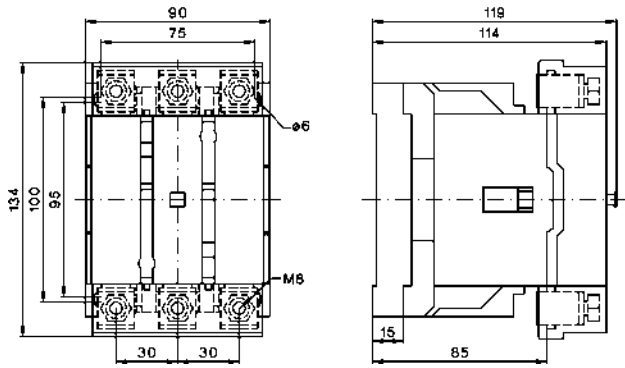

J7KN-200...

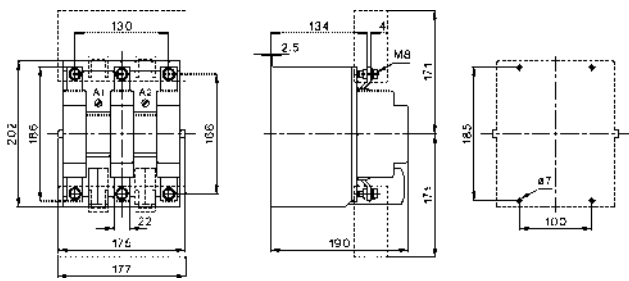

J7KN-150...
J7KN-175...

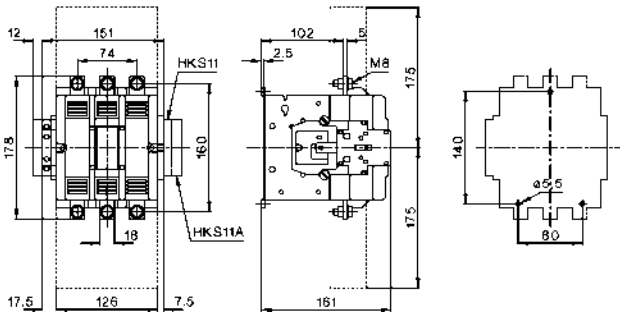

Auxiliary contact blocks

J73KN-B-01
J73KN-B-10

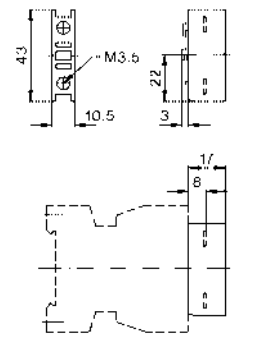

J73KN-C-11S

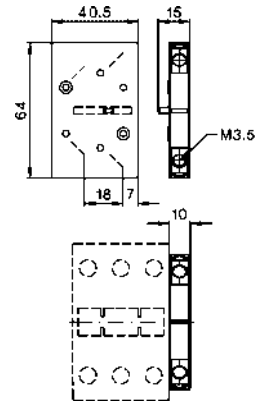

Pneumatic timer

J74KN-B-TP...

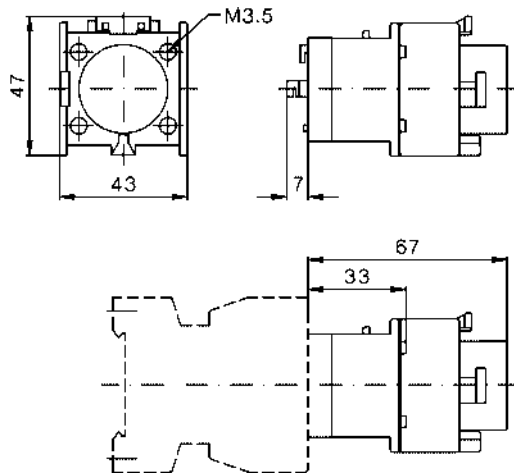

Auxiliary contact blocks

J74KN-A-VG

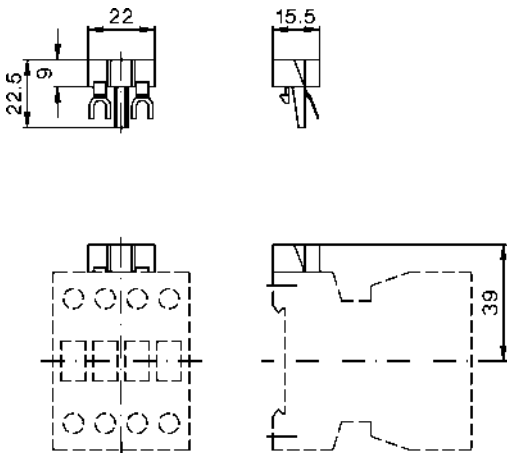

J74KN-B-VG

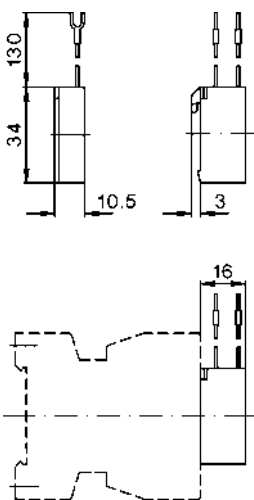

J74KN-A-RC

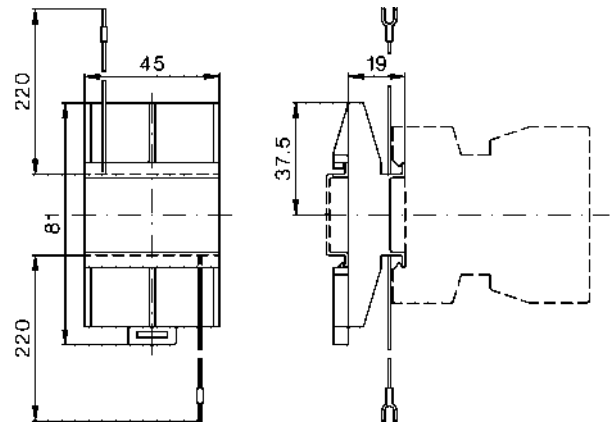

J74KN-B-RC

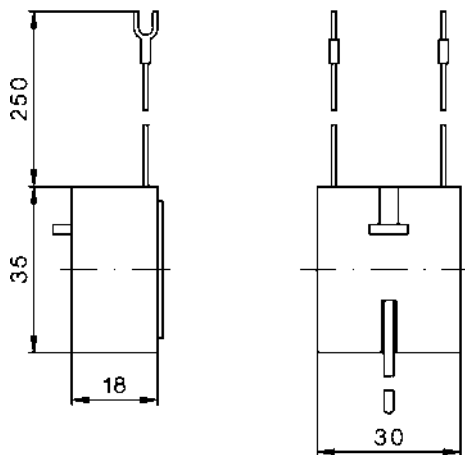

LVSG

Position of Terminals

AC operated

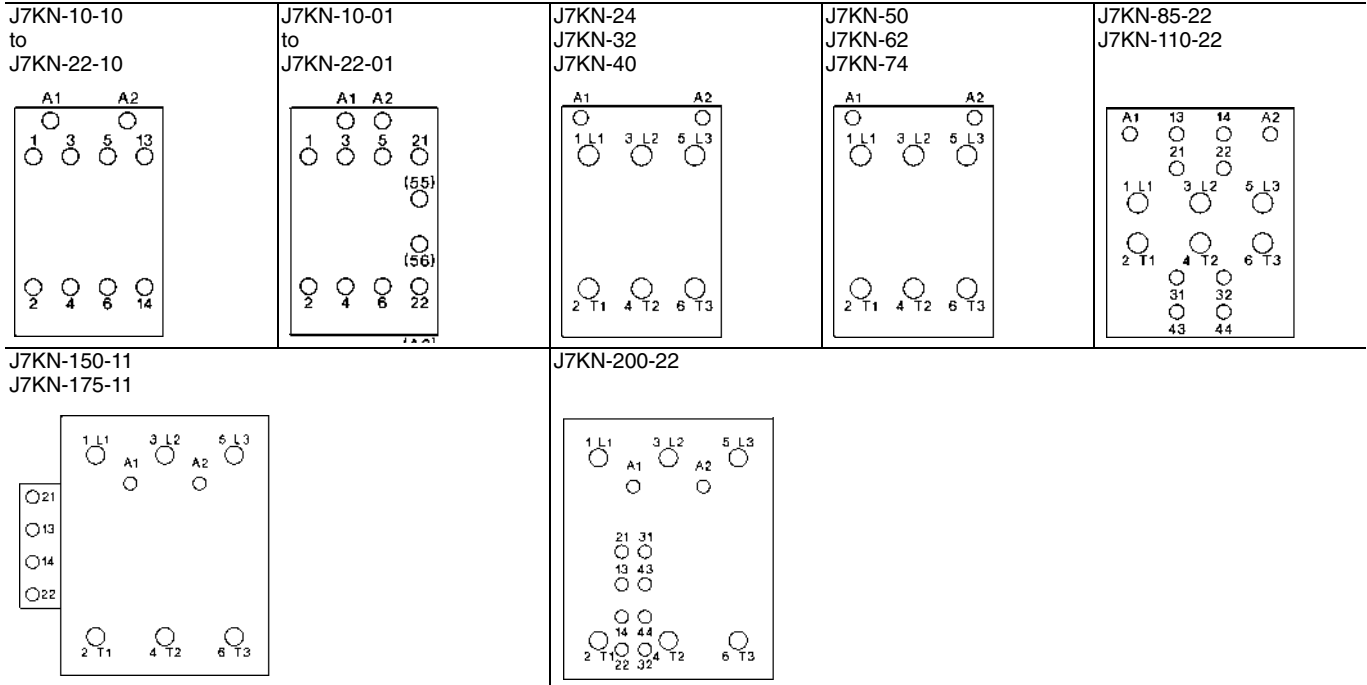

DC operated with double winding coil

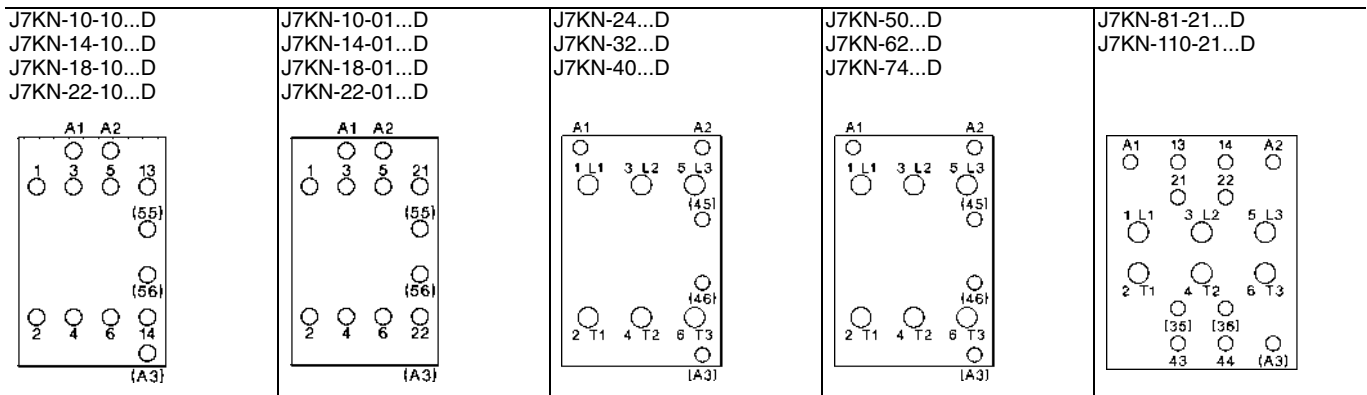

ALL DIMENSIONS SHOWN ARE IN MILLIMETERS.

Thermal Overload Relay J7TKN

Thermal Overload Relay

- Direct and separate mounting
- Single phasing sensitivity according to IEC 947-4-1
- Finger proof (VBG 4)

Accessories

- Busbar sets
- Set for single mounting

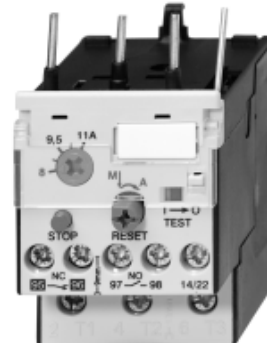

Approved Standards

Standard	Guide No (US,C)
UL	NKCR, NKCR7
ICE 947-4-1	
VDE 0660	
EN 60947-4-1	

Ordering Information

■ Model Number Legend

1. Thermal Overload Relay

J7TKN-□-□□□
1 2 3

- 1) Thermal Overload Relay
- 2) A: for mini motor contactor and motor contactor (4-11 kW)
B: for motor contactor (4-15 kW)
C: for motor contactor (18.5 kW)
D: for motor contactor (22-37 kW)
E: for motor contactor (45-55 kW)
F: for motor contactor (75-110 kW)
- 3) Setting range (examples)
E16: 0.12-0.16 A
E27: 0.18-0.27 A
...
2E7: 1.8-2.7 A
...
11: 8-11 A





2. Accessories for Thermal Overload Relay

J74TK-□□-□□□
1 2 3

- 1) Accessories for Thermal Overload Relay
- 2) SM: Single mounting for J7TKN-B Types (4-32 kW)
SU: Busbar sets
- 3) 175: for J7TKN-F Types (75-90 kW)
200: for J7TKN-F Types (110 kW)

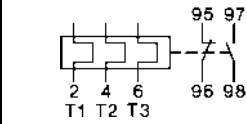

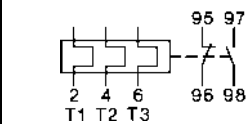
■ System overview

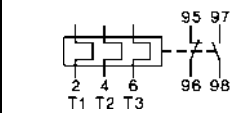
Thermal Overload Relays for plug-in mounting

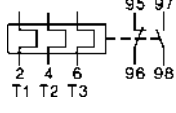
	Setting Range		Star Delta (A)		Type	Pack pcs.	Weight kg/pc.
	D.O.L. (A)	(A)					
For contactors J7KNA-09..., J7KNA-12..., J7KN-10... to J7KN-22...							
	0.12	- 0.18	-	 hand reset	J7TKN-A-E18	1	0.10
	0.18	- 0.27	-		J7TKN-A-E27	1	0.10
	0.27	- 0.4	-		J7TKN-A-E4	1	0.10
	0.4	- 0.6	-		J7TKN-A-E6	1	0.10
	0.6	- 0.9	-		J7TKN-A-E9	1	0.10
	0.8	- 1.2	-		J7TKN-A-1E2	1	0.10
	1.2	- 1.8	-		J7TKN-A-1E8	1	0.10
	1.8	- 2.7	-		J7TKN-A-2E7	1	0.10
	2.7	- 4	-		J7TKN-A-4	1	0.10
	4	- 6	7 - 10.5		J7TKN-A-6	1	0.10
	6	- 9	10.5 - 15.5		J7TKN-A-9	1	0.10
	8	- 11	14 - 19		J7TKN-A-11	1	0.10
	10	- 14	18 - 24		J7TKN-A-14	1	0.10
	13	- 18	23 - 31		J7TKN-A-18	1	0.10
17	- 23	30 - 40	J7TKN-A-23	1	0.10		
22	- 30	38 - 52	J7TKN-A-30	1	0.10		
For contactors J7KN-10... to J7KN-40...							
	0.12	- 0.18	-	 hand- and auto reset	J7TKN-B-E18	1	0.14
	0.18	- 0.27	-		J7TKN-B-E27	1	0.14
	0.27	- 0.4	-		J7TKN-B-E4	1	0.14
	0.4	- 0.6	-		J7TKN-B-E6	1	0.14
	0.6	- 0.9	-		J7TKN-B-E9	1	0.14
	0.8	- 1.2	-		J7TKN-B-1E2	1	0.14
	1.2	- 1.8	-		J7TKN-B-1E8	1	0.14
	1.8	- 2.7	-		J7TKN-B-2E7	1	0.14
	2.7	- 4	-		J7TKN-B-4	1	0.14
	4	- 6	7 - 10.5		J7TKN-B-6	1	0.14
	6	- 9	10.5 - 15.5		J7TKN-B-9	1	0.14
	8	- 11	14 - 19		J7TKN-B-11	1	0.14
	10	- 14	18 - 24		J7TKN-B-14	1	0.14
	13	- 18	23 - 31		J7TKN-B-18	1	0.14
17	- 24	30 - 41	J7TKN-B-24	1	0.14		
23	- 32	40 - 55	J7TKN-B-32	1	0.14		
For contactors J7KN-24... to J7KN-40...							
	28	- 42	48 - 73		J7TKN-C-42	1	0.30

	Setting Range			Type	Pack pcs.	Weight kg/pc.
	D.O.L. (A)	Star Delta (A)				
For contactors J7KN-50...-J7KN-74...						
	40 - 52	70 - 90		J7TKN-D-52	1	0.40
	52 - 65	90 - 112		J7TKN-D-65	1	0.40
	60 - 74	104 - 128		J7TKN-D-74	1	0.40

Thermal Overload relays for separate mounting

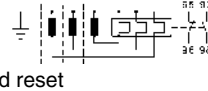
	Setting Range			Type	Pack pcs.	Weight kg/pc.
	D.O.L. (A)	Star Delta (A)				
For contactors J7KN-85... to J7KN-150...						
	60 - 90	104 - 156		J7TKN-E-90	1	0.90
	80 - 120	140 - 207		J7TKN-E-120	1	0.90
For contactors J7KN-175... to J7KN-200...						
	100 - 150	175 - 260		J7TKN-F-150	1	1.5
	140 - 220	240 - 380		J7TKN-F-210	1	1.5
			busbar sets see accessories			

Accessories

	for overload relays	for contactors	Type	Pack pcs.	Weight kg/pc.
Busbar Sets					
	J7TKN-F-175	J7KN-150, J7KN-175	J74TK-SU-175	1	0.6
	J7TKN-F-210	J7KN-200	J74TK-SU-200	1	0.7
	busbars must be installed by users				

	for overload relay	Cable Cross-section to clamp (mm ²)			Type	Pack pcs.	Weight kg/pc.
		solid or stranded	flexible	flex. with multicore cable end			
Sets for single mounting							
	J7TKN-B	0.75 - 6	0.75 - 4	0.5 - 4	J74TK-SM	1	0.035

LVSG

Specifications

■ Engineering data and Characteristics

Thermal Overload Relays, tripping times for selection to motors of protection degree EEx e
Relays With Standard Tripping Characteristic

Setting Range		Tripping time depending on the multiple of the current setting from cold condition (tolerance ±20% of the tripping time)					
		I_A/I_N	I_A/I_N	I_A/I_N	I_A/I_N	I_A/I_N	I_A/I_N
A		3	4	5	6	7,2	8
J7TKN-A-...		s	s	s	s	s	s
0,12	- 0,18	18,5	10,4	7,2	5,5	4,3	3,6
0,18	- 0,27	16,7	9,8	6,5	5	4,1	3,5
0,27	- 0,4	19,4	12,1	8,2	5,9	4,9	4,2
0,4	- 0,6	18,7	11,2	8	6	4,9	4,1
0,6	- 0,9	19,7	11,6	8,1	6,1	4,9	4,2
0,8	- 1,2	22,9	13,6	10	7,3	6	5,2
1,2	- 1,8	22,2	13,2	9,2	7,6	5,8	5,3
1,8	- 2,7	23	13,7	9,3	7,6	5,7	5,1
2,7	- 4	24	14,4	9,9	7,8	5,9	5,1
4	- 6	24,7	13,8	9,9	7,3	5,6	4,8
6	- 9	22	13,4	8	5,7	4,1	3,5
8	- 11	17,4	9,2	5,9	4,1	2,9	2,3
10	- 14	26,4	12,9	7,6	5,2	3,5	2,8
13	- 18	14,7	7,7	4,8	3,2	2,3	1,7
17	- 23	16,2	8,4	5	3,6	2,4	1,8
22	- 30	16,8	8,5	5	3,6	2,3	1,9
J7TKN-C-42		s	s	s	s	s	s
28	- 42	25,2	13,3	8	5,5	4	3,1
J7TKN-D-...		s	s	s	s	s	s
40	- 52	18,3	9,2	5,6	3,9	2,8	2,2
52	- 65	17,8	8,7	5,2	3,4	2,5	1,9
60	- 74	19,5	13,5	11	10	9,5	8,5
J7TKN-E-...		s	s	s	s	s	s
60	- 90	19,5	13,5	11	10	9,5	8,5
80	- 120	18	11	10	9	8,5	8
J7TKN-F-...		s	s	s	s	s	s
100	- 150	34	26	24	20,5	19	18
140	- 210	30	24	21	18,5	17	16

All tripping times of overload relays J7TKN-A are shorter than the minimum values of the t_E time for motors of protection degree EEx e acc. to EN 50019 and therefore are suitable for all motors of protection degree EEx e. For these overload relays the selection on basis of tripping curves is thereby not necessary.

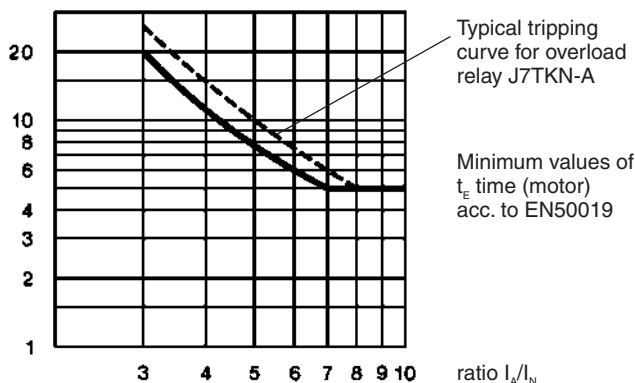

Labels of tripping curves for each setting range, sized 148x105mm (self-adhesive) are available on request.

Specify type and setting range.

When selecting a standard overload, refer to the tripping curve. Determine the values of the starting current ratio I_A/I_N and the time t_E which is marked on the label of the motor. The overload must trip within the t_E time, which means that the tripping curve from cold condition must be (20% due to tolerance) below the coordination point I_A/I_N and the time t_E .

I_A = Starting current of motor

I_N = Rated current of motor

t_E = t_E -time of motor

Fuses for J7TKN-A; J7TKN-B; J7TKN-C; J7TKN-D; J7TKN-E; J7TKN-F

Type	Setting Range				Max. Fuse Size According to Coordination-type				Fuse UL		
	DOL		Star Delta		"2" ^{*1} quick	slow, gL(gG)	"1" ^{*1} slow, gL(gG)	aM			
	A		A		A	A	A	A			
J7TKN-A	0.12	-	0.18	-	-	0.5 ^{*2}	0.5 ^{*2}	25	-	15	
J7TKN-B	0.18	-	0.27	-	-	1.0 ^{*2}	1.0 ^{*2}	25	-	15	
	0.27	-	0.4	-	-	2	2	25	-	15	
	0.4	-	0.6	-	-	2	2	25	-	15	
	0.6	-	0.9	-	-	4	4	25	-	15	
	0.8	-	1.2	-	-	4	4	25	2	15	
	1.2	-	1.8	-	-	6	6	25	2	15	
	1.8	-	2.7	-	-	10	10	25	4	15	
	2.7	-	4	-	-	16	10	25	4	15	
	4	-	6	7	-	10.5	20	16	25	6	15
	6	-	9	10.5	-	15.5	35	25	35	10	25
	8	-	11	14	-	19	35	25	35	16	30
	10	-	14	18	-	24	50	35	63	16	40
	13	-	18	23	-	31	50	35	63	20	50
	17	-	(23)24	30	-	(40)41	63	50	63	25	60
	(22)23	-	(30)32	(38)40	-	(52)55	80	63	80	35	70
J7TKN-C	28	-	42	48	-	73	100	80	150	50	110
J7TKN-D	40	-	52	70	-	90	160	100	150	63	200
	52	-	65	90	-	112	160	125	150	80	250
	60	-	74	104	-	128	160	125	150	80	250
J7TKN-E	60	-	90	104	-	156	For short circuit protecting overload relays with current transformer use fuse according to the 7contactor of the combination.			300	
	80	-	120	140	-	207				-	
J7TKN-F	all ranges										

*1) Coordination-type according to IEC 947-4-1:

„2“: Light contact welding accepted. Thermal overload relay must not be damaged.

„1“: Welding of contactor and damage of the thermal overload relay allowed.

*2) Miniature fuse

Tripping Characteristics for J7TKN-A, J7TKN-B, J7TKN-C, J7TKN-D

Detailed tripping times for each range see table page 60

with three-phase load

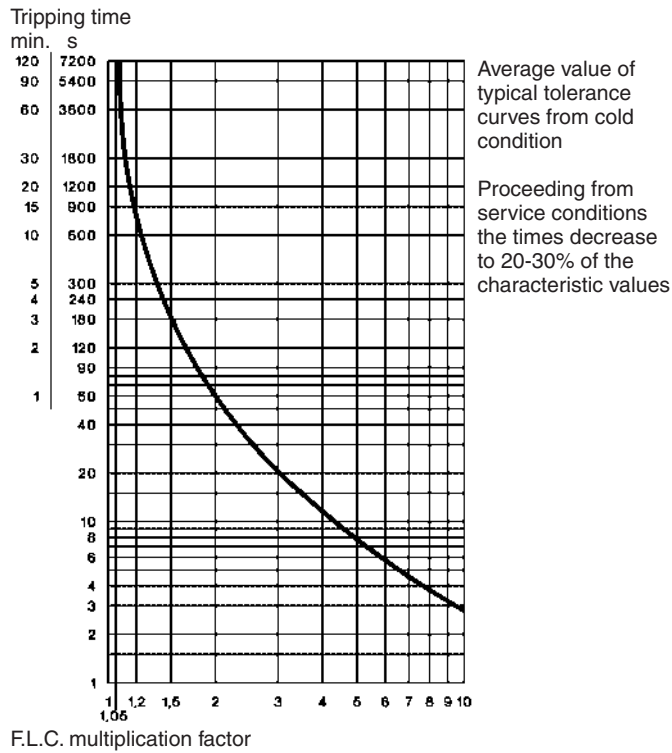

with two-pole load

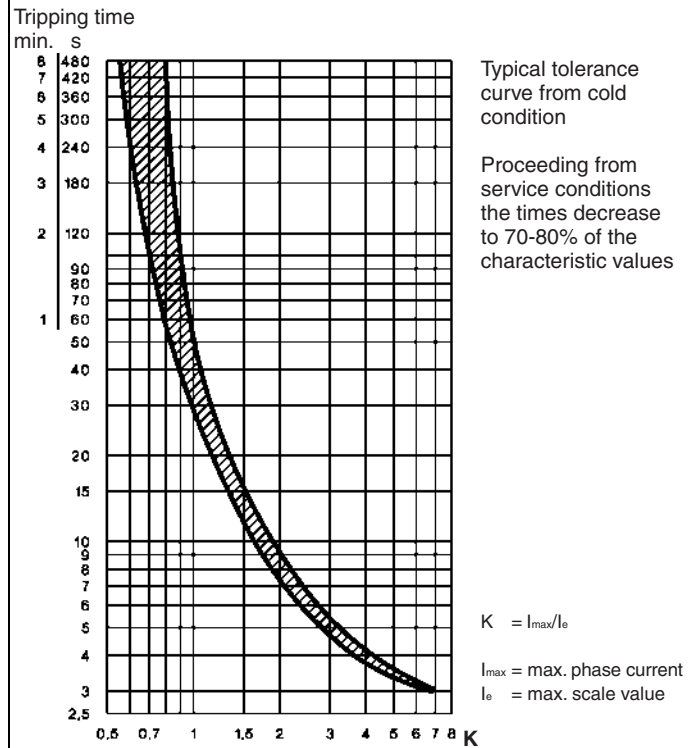

Tripping Characteristics for J7TKN-E

Detailed tripping times for each range see table page 60

with three-phase load

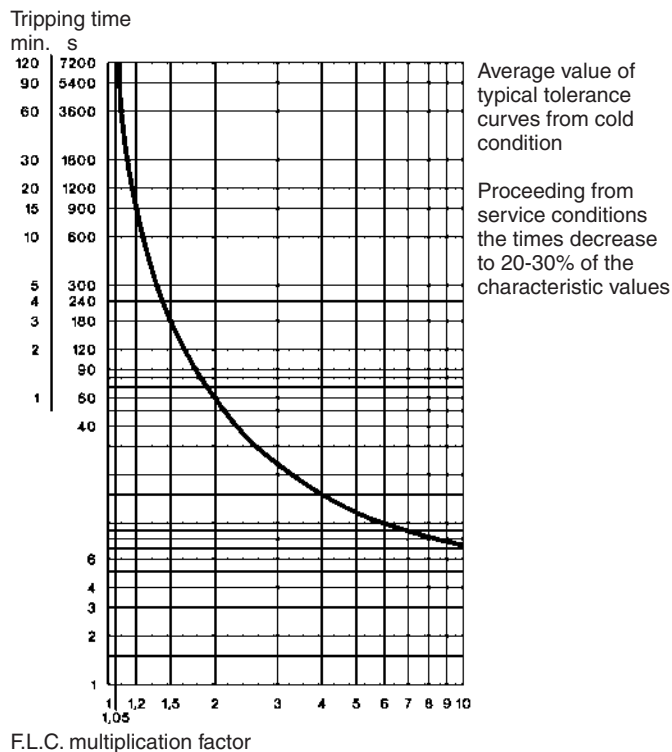

with two-pole load

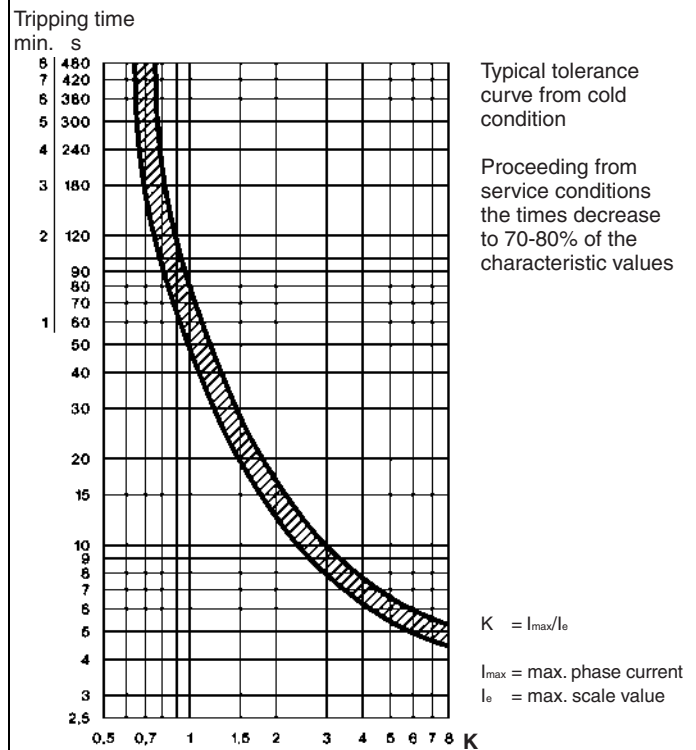

Tripping Characteristics for J7TKN-F

Detailed tripping times for each range see table page 60

with three-phase load

Tripping time
min. s

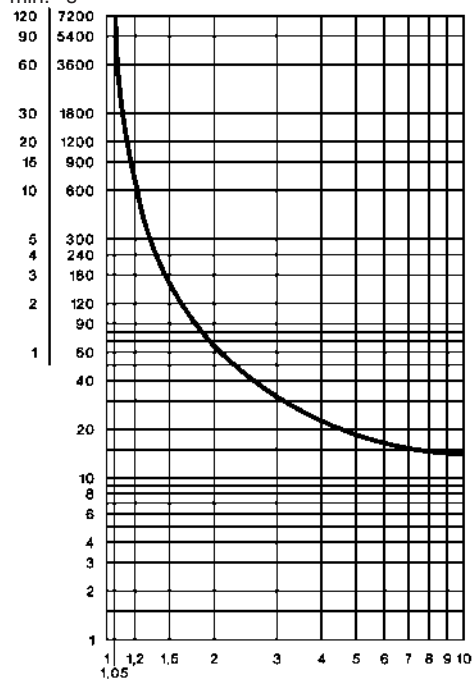

Average value of typical tolerance curves from cold condition

Proceeding from service conditions the times decrease to 20-30% of the characteristic values

F.L.C. multiplication factor

with two-pole load

Tripping time
min. s

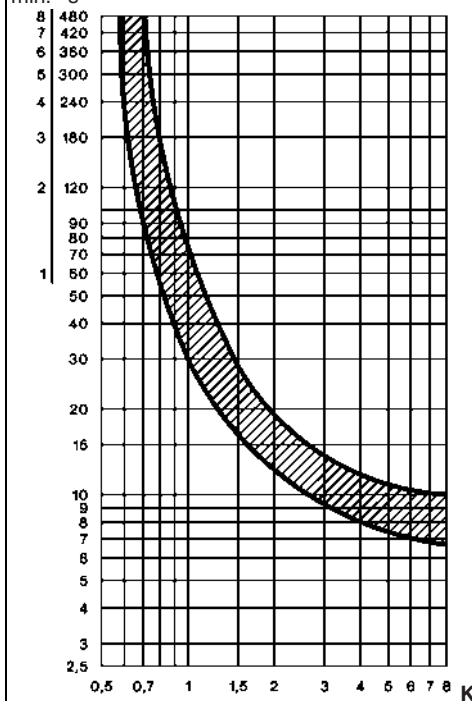

Typical tolerance curve from cold condition

Proceeding from service conditions the times decrease to 70-80% of the characteristic values

$$K = I_{max}/I_e$$

I_{max} = max. phase current
 I_e = max. scale value

Position of Terminals

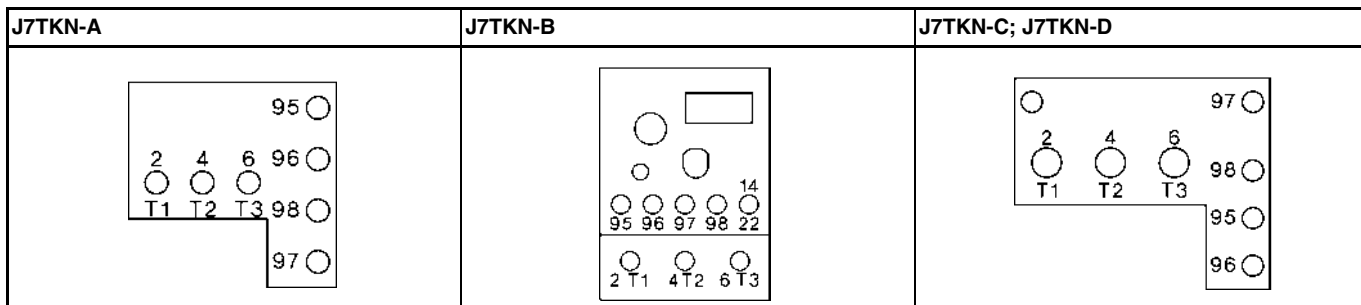

LVSG

Thermal Overload Relays

Data according to IEC 947-4-1, IEC 947-5-1, VDE 0660, EN 60947-4-1, EN 60947-5-1

Type		J7TKN-A	J7TKN-B	J7TKN-C	J7TKN-D	J7TKN-E	J7TKN-F
Rated insulation voltage U_i^{*1}	V~	690	690	690	690	750	690
Permissible ambient temperature							
operation	open °C				-25 to +60		
storage	°C				-50 to +70		
Trip class according to IEC 947-4-1							
		10A	10A	10A	10A	20	20
Cable cross-section							
main connector	solid or stranded	mm ² 0.75-6 + 0.75-2.5 ^{*2}	0.75-6	0,75-10	4-35 ^{*2}	*3	*4
	flexible	mm ² 0.75-4 + 0.5-2.5 ^{*2}	1-4	0,75-6	6-25 ^{*2}		
	flexible with multicore cable end	mm ² 0.5-2.5 + 0.5-1.5	0.75-4	0.75-6	4-25		
Cables per clamp	number	1+1	2	2	1		
auxiliary connector	solid	mm ²			0.75-2.5 ^{*2}		
	flexible	mm ²			0.5-2.5 ^{*2}		
	flexible with multicore cable end	mm ²			0.5-1.5		
Cables per clamp	number				2		
Auxiliary contacts							
Rated insulation voltage U_i^{*1}							
same potential	V~	690	690		690		690
different potential	V~	440	440		250		440
Utilization category AC15							
Rated operational current I_e	24V A	5	3		4 ^{*5}		5
	230V A	3	2		2.5		3
	400V A	2	1		1.5		2
	690V A	0.6	0.5		0.6		0.6
Utilization category DC13							
Rated operational current I_e	24V A	1.2	1		1.2		1.2
	110V A	0.15	0.15		0.15		0.15
	220V A	0.1	0.1		0.1		0.1
Short circuit protection (without welding 1kA)							
highest fuse rating	gL (gG) A	6	4		6		6
Setting range							
	A	to 23	all	28-42	52-65	all	-
Power loss per current path (max.)							
minimum setting value	W	1.1	1.1	1.3	2.9	1.1	-
maximum setting value	W	2.3	2.3	3.3	4.5	2.5	-

*1) Suitable for: earthed-neutral systems, overvoltage category I to III, pollution degree 3 (standard-industry: U_{imp} = 4kV (at 440V), 6kV (at 690V). Data for other conditions on request.

*2) Maximum cable cross-section with prepared conductor

*3) Without terminals, suitable for bushing one connector 70mm² (stranded) per phase

*4) Busbar sets see accessories page 59

*5) Switching capacity of the start contact: AC15 300VA, max. 1.5A, DC13 (max. 220V) 30W, max. 1.5A

Data according to cULus

Type		J7TKN-A	J7TKN-B	J7TKN-C	J7TKN-D	J7TKN-E
Rated insulation voltage	V~	600	600	600	600	600
Rated current	A	23	32	42	74	85
Auxiliary contacts						
Rated voltage						
same potential	V AC	600	600	600	600	600
different potential	V~	150	150	150	150	150
Switching capacity AC						
of aux. contacts	VA	500	500	600	600	600
	A	4	2	4	4	4

Temperature Compensation

In case of higher ambient temperature use the following formula:
 (Ambient temperature - 20) x 0.125 = correction factor in % of the
 full load motor current

Example:

Ambient temperature 70°C, full load motor current 7A

$(70 - 20) \times 0.125 = 6.25\%$

Setting value: $7A + 6,25\% = 7.44A$

■ Dimensions

J7KNA-09 + J7TKN-A
J7KNA-12

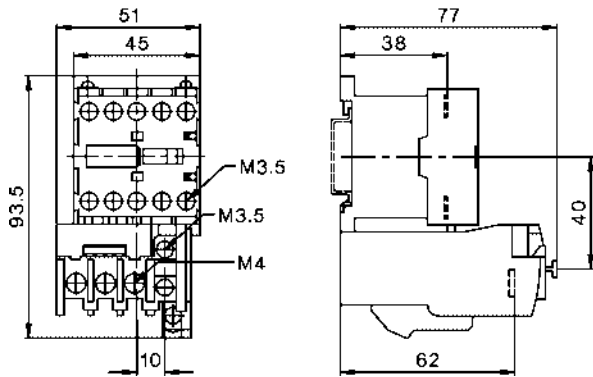

J7KN-10 + J7TKN-B
J7KN-14
J7KN-18
J7KN-22

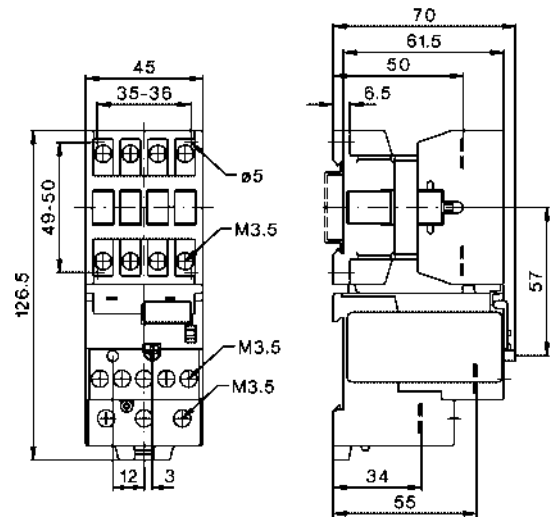

J7KN-10 + J7TKN-A
J7KN-14
J7KN-18
J7KN-22

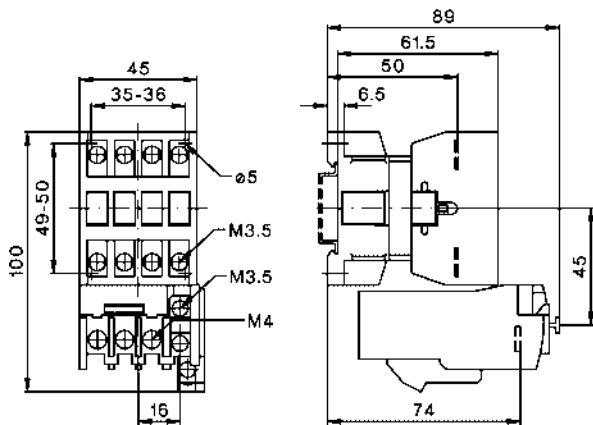

J7KN-24 + J7TKN-B
J7KN-32
J7KN-40

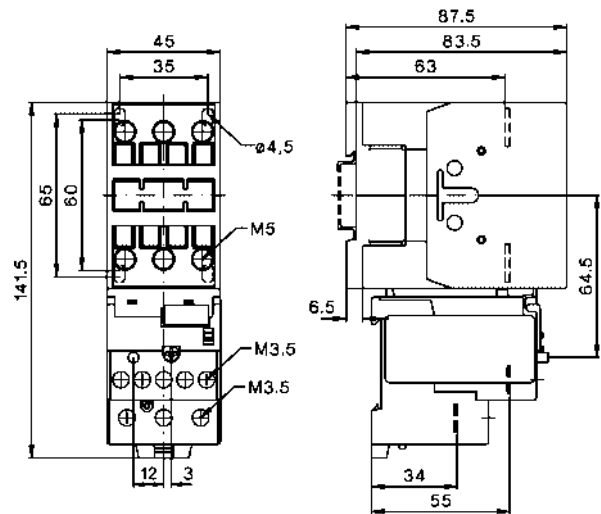

J7KN-24 + J7TKN-C
J7KN-32
J7KN-40

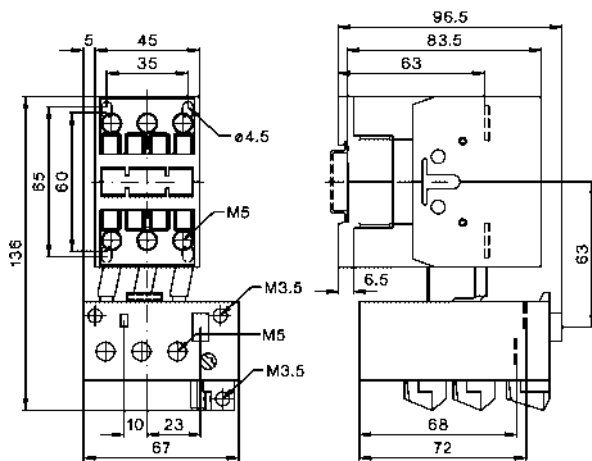

J7KN-50 + J7TKN-D
J7KN-62
J7KN-74

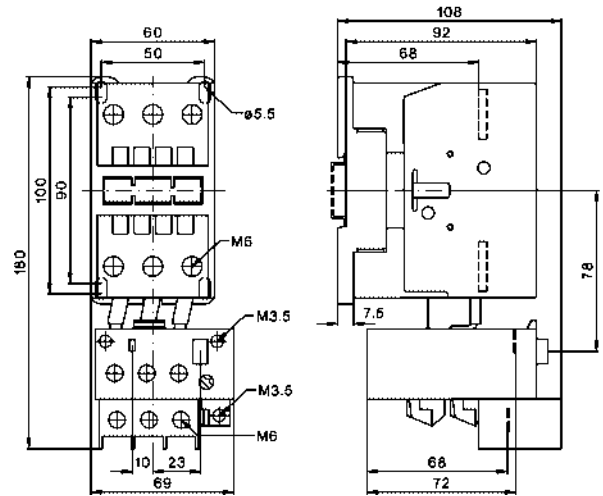

J7KN-85 + J7TKN-E
J7KN-110

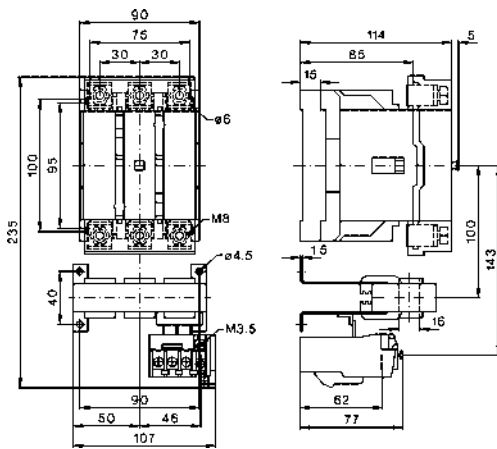

J7KN-150 + J7TKN-F
J7KN-175

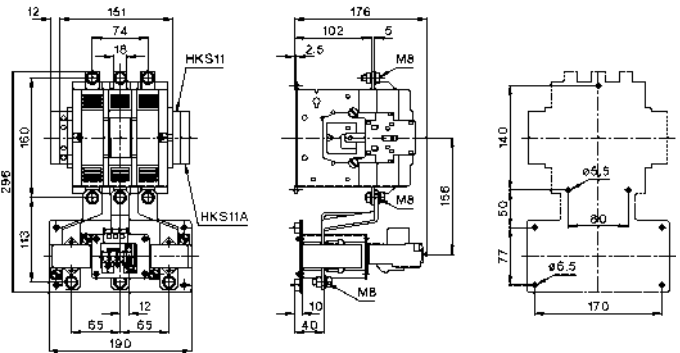

J7KN-200 + J7TKN-210

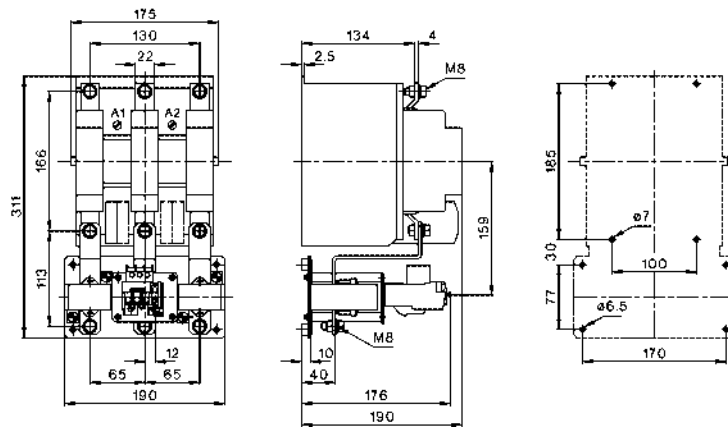

LVSG

ALL DIMENSIONS SHOWN ARE IN MILLIMETERS.

Cat. No. J509-E2-02A

In the interest of product improvement, specifications are subject to change without notice.

Motor Protection Circuit Breaker (MPCB) J7MN

MPCB system (motor protection CLASS 10)

- Rotary and switch types
- Rated operational current = 12 A, 25 A, 50 A and 100 A
- Switching capacity up to 12.5 A = 100 kA/400 V
- Fixed short-circuit release = $13 \times I_u$
- Overload release adjustable 0.7 - $1 \times I_u$
- Single phasing sensitivity

Auxiliary contact modules

- ON/OFF indication for MPCB front mounting and side mounting
- Trip indication for MPCB side mounting

Accessories

- Undervoltage release
- Shunt release
- Three phase busbar system up to 5 MPCB
- Moulded plastic enclosures (IP55)
- Moulded plastic front plates (IP55)
- Door coupling rotary mechanisms (black and red/yellow)



Approved Standards

Standard	Guide No (US,C)
UL	see page 95
ICE 947-5-1	
VDE 0660	
EN 60947-5-1	

Ordering Information

■ Model Number Legend

1. Motor Protection Circuit Breaker (MPCB)

J7MN-□□-□□□
1 2 3

- 1) Motor Protection Circuit Breaker (MPCB)
- 2) Type
 - 12: Switch type (0.16 - 12 A)
 - 25: Rotary type (0.16 - 25 A)
 - 50: Rotary type (25 - 40 A)
 - 100: Rotary type (45 - 100 A)
- 3) Setting range (examples)
 - E16: 0.11 - 0.16 A
 - E2: 0.14 - 0.2 A
 - 16: 10 - 16 A
 - ...

2. Aux. Contacts for MPCB

J73MN-□□□
1 2 3

- 1) Aux. Contact for MPCB
- 2) 11: 1 NO 1 NC
- 3) S: side mounting
F: front mounting

J73MN-□-□□□
1 2 3 4

- 1) Aux. Contact for MPCB
- 2) T: Trip indicating contact
- 3) 11: 1 NO 1 NC
- 4) S: side mounting

3. Accessories for MPCB

J74MN-□-□□
1 2 3

- 1) Accessories for MPCB
- 2) S: Shunt release
U: Under voltage release
- 3) N1: 230 V 50 Hz / 240 V 60 Hz
N2: 210 - 230 V 50/60 Hz

J74MN-□□□□
1 2 3

- 1) Accessories for MPCB
- 2) PF: Enclosure IP55
P: Module plastic front plate
PH: Holder for front plate
- 3) 12: Switch type
25: Rotary type

J74MN-□□-□□
1 2 3

- 1) Accessories for MPCB
- 2) DC: Door coupling rotary mechanism
- 3) B: black / gray
RY: red / yellow

J74MN-□□-□□□
1 2 3

- 1) Accessories for MPCB
- 2) L3: 3-phase busbar system (45 mm modular spacing)
DS: Shroud for unused terminal
- 3) 1/2: for 2 circuit breakers
1/3: for 3 circuit breakers
1/4: for 4 circuit breakers
1/5: for 5 circuit breakers

J74MN-□□□□
1 2 3

- 1) Accessories for MPCB
- 2) TC: Line side terminal
- 3) 12: for switch type
25: for rotary type

J74MN-□□□□□
1 2 3

- 1) Accessories for MPCB
- 2) TB: Terminal block for UL/cUL type E
- 3) 25: for rotary type up to 25A
100: for rotary type up to 100A



■ System overview

Motor Protection Circuit Breaker (MPCB)

	Rated current	Suitable for motors*1 3~400V kW	Current setting range		Short-circuit breaking capacity at 3~400V kA	Type	Pack pcs.	Weight approx. kg/pcs.
	In A		Thermal overload release A	Instantaneous short-circuit release A				
Circuit-Breakers J7MN-12								
	0.16	-	0.11 – 0.16	2.1	100	J7MN-12-E16	1	0.21
	0.2	-	0.14 – 0.2	2.6	100	J7MN-12-E2	1	0.21
	0.25	0.06	0.18 – 0.25	3.3	100	J7MN-12-E25	1	0.21
	0.32	0.09	0.22 – 0.32	4.2	100	J7MN-12-E32	1	0.21
	0.4	-	0.28 – 0.4	5.2	100	J7MN-12-E4	1	0.21
	0.5	0.12	0.35 – 0.5	6.5	100	J7MN-12-E5	1	0.21
	0.63	0.18	0.45 – 0.63	8.2	100	J7MN-12-E63	1	0.21
	0.8	-	0.55 – 0.8	10	100	J7MN-12-E8	1	0.21
	1	0.25	0.7 – 1	13	100	J7MN-12-1	1	0.21
	1.25	0.37	0.9 – 1.25	16	100	J7MN-12-1E25	1	0.21
	1.6	0.55	1.1 – 1.6	21	100	J7MN-12-1E6	1	0.21
	2	0.75	1.4 – 2	26	100	J7MN-12-2	1	0.21
	2.5	-	1.8 – 2.5	33	100	J7MN-12-2E5	1	0.21
	3.2	1.1	2.2 – 3.2	42	100	J7MN-12-3E2	1	0.21
	4	1.5	2.8 – 4	52	100	J7MN-12-4	1	0.21
	5	-	3.5 – 5	65	100	J7MN-12-5	1	0.21
6.3	2.2	4.5 – 6.3	82	100	J7MN-12-6E3	1	0.21	
8	3	5.5 – 8	104	50	J7MN-12-8	1	0.21	
10	4	7 – 10	130	50	J7MN-12-10	1	0.21	
12	5.5	9 – 12	156	50	J7MN-12-12	1	0.21	

*1) Recommended values for standard motors





*2) max. motor current 95A

	Rated current	Suitable for motors*1 3~400V kW	Current setting range		Short-circuit breaking capacity at 3~400V kA	Type	Pack pcs.	Weight approx. kg/pcs.
	In A		Thermal overload release A	Instantaneous short-circuit release A				
Circuit-Breakers J7MN-25								
	0.16	-	0.11 – 0.16	2.1	100	J7MN-25-E16	1	0.32
	0.2	-	0.14 – 0.2	2.6	100	J7MN-25-E2	1	0.32
	0.25	0.06	0.18 – 0.25	3.3	100	J7MN-25-E25	1	0.32
	0.32	0.09	0.22 – 0.32	4.2	100	J7MN-25-E32	1	0.32
	0.4	-	0.28 – 0.4	5.2	100	J7MN-25-E4	1	0.32
	0.5	0.12	0.35 – 0.5	6.5	100	J7MN-25-E5	1	0.32
	0.63	0.18	0.45 – 0.63	8.2	100	J7MN-25-E63	1	0.32
	0.8	-	0.55 – 0.8	10	100	J7MN-25-E8	1	0.32
	1	0.25	0.7 – 1	13	100	J7MN-25-1	1	0.32
	1.25	0.37	0.9 – 1.25	16	100	J7MN-25-1E25	1	0.32
	1.6	0.55	1.1 – 1.6	21	100	J7MN-25-1E6	1	0.32
	2	0.75	1.4 – 2	26	100	J7MN-25-2	1	0.32
	2.5	-	1.8 – 2.5	33	100	J7MN-25-2E5	1	0.32
	3.2	1.1	2.2 – 3.2	42	100	J7MN-25-3E2	1	0.32
	4	1.5	2.8 – 4	52	100	J7MN-25-4	1	0.32
	5	-	3.5 – 5	65	100	J7MN-25-5	1	0.32
	6.3	2.2	4.5 – 6.3	82	100	J7MN-25-6E3	1	0.32
	8	3	5.5 – 8	104	100	J7MN-25-8	1	0.32
	10	4	7 – 10	130	100	J7MN-25-10	1	0.32
	12.5	5.5	9 – 12.5	163	100	J7MN-25-12E5	1	0.32
16	7.5	11 – 16	208	50	J7MN-25-16	1	0.32	
20	-	14 – 20	260	50	J7MN-25-20	1	0.32	
22	-	17 – 22	286	50	J7MN-25-22	1	0.32	
25	11	20 – 25	325	50	J7MN-25-25	1	0.32	
Circuit-Breakers J7MN-50								
	25	11	18 – 25	325	50	J7MN-50-25	1	0.96
	32	15	22 – 32	416	50	J7MN-50-32	1	0.96
	40	18.5	28 – 40	520	50	J7MN-50-40	1	0.96
	45	-	36 – 45	585	50	J7MN-50-45	1	0.96
	50	22	40 – 50	650	50	J7MN-50-50	1	0.96
Circuit-Breakers J7MN-100								
	63	30	45 – 63	819	50	J7MN-100-63	1	2.1
	75	37	57 – 75	975	50	J7MN-100-75	1	2.1
	90	-	70 – 90	1170	50	J7MN-100-90	1	2.1
	100	45	80 – 100*2	1235	50	J7MN-100-100	1	2.1



*1) Recommended values for standard motors

*2) max. motor current 95A

Accessories

	Description	Version	for circuit breaker	Type	Pack pcs.	Weight approx. kg/pcs.
Transverse auxiliary contact block						
	Contact block	1NO + 1NC	all	J73MN-11F	10	0.02
Auxiliary contact block for left hand side mounting (max 1pc. per circuit breaker)						
	Contact block	1NO + 1NC 9 mm	all	J73MN-11S	10	0.03
Signalling switch for left hand side mounting (max 1pc. per circuit breaker)						
	Signalling switch	1NO + 1NC each Individual tripped and short-circuit signalling	J7MN-25 J7MN-50	J73MN-T-11S	1	0.07
Auxiliary releases for right hand side mounting (max 1pc. per circuit breaker)						
	Undervoltage release Trips the circuit-breaker when the voltage is interrupted. Prevents the motor from being restarted accidentally when the voltage is restored, suitable for EMERGENCY STOP acc. to VDE 0113	AC 50 Hz 230 V AC 60 Hz 240 V	all	J74MN-U-N1	1	0.12
	Shunt release Trips the circuit-breaker when the release coil energized.	50/60 Hz 100% ON 210-240 V 50/60 Hz, DC 5 sec ON 190-330 V	J7MN-12	J74MN-S-N2	1	0.11

Enclosures and Front Plates

	Description	Version	for circuit breaker	Type	Pack pcs.	Weight approx. kg/pcs.
Front Plates						
	Moulded plastic front plate with actuator diaphragm and holder for circuit breaker	for actuation of circuit-breakers in any enclosure protection degree IP55	J7MN-12	J74MN-P12	1	0.08
	Moulded plastic front plate with rotary operating mechanism lockable	for actuation of circuit-breakers in any enclosure protection degree IP55	J7MN-25 J7MN-50	J74MN-P25	1	0.08
	Holder for front plate J74MN-P25	Holder is mounted on front plate, circuit-breaker (with accessories) is snapped on	J7MN-25	J74MN-PH	1	0.12
Enclosures						
	Moulded plastic enclosure with actuator diaphragm knockouts for J7MN-25 sealable	protection degree IP55 with N- and PE- terminal (+ aux. contact + release)	J7MN-12	J74MN-PF12	1	0.27

LVSG

	Description	Version	for circuit breaker	Type	Pack pcs.	Weight approx. kg/pcs.
	Moulded plastic enclose with rotary operating mechanism knockouts for J7MN-25 lockable	protection degree IP55 with N- and PE- terminal (+ aux. contact + release)	J7MN-25	J74MN-PF25	1	0.30



Door-coupling mechanisms

	The door-coupling rotary operating mechanisms consist of a knob, a coupling driver and a extension shaft (5 mm x 5 mm). The door-coupling rotary operating mechanisms are designed for degree of protection IP 65. The door locking device prevents accidental opening of the cubicle door in the ON position of the circuit-breaker. The OFF position can be locked with up to 3 padlocks.					
	Door-coupling rotary mechanism black	extension shaft 330 mm with supporting bracket	J7MN-25 to J7MN-50	J74MN-DC-B	1	0.3
	Emergency-Stop Door-coupling rotary mechanism red/yellow	extension shaft 330 mm with supporting bracket	J7MN-25 to J7MN-50	J74MN-DC-RY	1	0.3

Busbars

	Description	Version	for circuit breaker	Type	Pack pcs.	Weight approx. kg/pcs.
--	-------------	---------	---------------------	------	-----------	------------------------

Insulated 3-phase busbar systems

	For feeding several modular circuit-breakers on standard mounting rails, insulated, shock-protected. Rated operational voltage max. 690 V					
	3-phase busbars modular spacing 45 mm	for 2 circuit-breakers for 3 circuit-breakers for 4 circuit-breakers for 5 circuit-breakers	J7MN-12 J7MN-25	J74MN-L3-1/2 J74MN-L3-1/3 J74MN-L3-1/4 J74MN-L3-1/5	1 1 1 1	0.03 0.05 0.07 0.10
	For connecting the 3-phase busbars from circuit-breakers different sizes. Clamping together J7MN-12 and J7MN-25 circuit-breakers is not possible due to the different modular spacings and the different heights of the terminals.					
	Line side terminal 3-pole, connection from top	Conductor cross-section solid or stranded 6- 25 mm ² with ferrule 4-16 mm ²	J7MN-12 J7MN-25	J74MN-TC12 J74MN-TC25	1 1	0.04 0.04
	Shroud	for unused terminals	J7MN-12 J7MN-25	J74MN-DS	20	-

Mounting Parts for Fuseless Load Feeders

	Description	Version	for circuit breaker	Type	Pack pcs.	Weight approx. kg/pcs.
--	-------------	---------	---------------------	------	-----------	------------------------

DIN-rail adapters

	Adapter for mechanical fixing of circuit-breaker and contactor	35 mm-DIN-rail (DIN EN50022) or screw mounting	J7MN...	J74MN-HU	10	0.05
---	--	--	---------	-----------------	----	------

Link modules

	for electrical connection between circuit-breaker and contactor					
	Link module	up to 20 A up to 32 A	J7MN...	J74MN-VD-12 J74MN-VD-25	10 10	- -

Terminal block

	with increased creepage distances and clearances acc. to cULus Type „E“					
	Terminal block	up to 600 V acc. to UL 489 not for transverse aux. contact block	J7MN-25 J7MN-100	J74MN-TB25 J74MN-TB100	1 1	0.12 0.15

Specifications

■ Engineering data and Characteristics

Components for Fuseless Load Feeders, DIN-Rail Mounting

Type of coordination „1“ 3 x 415 V 10 kA (other conditions on request)

Motor 3-400V kW	Setting range A	Circuit-breaker page 72 Type	Contactur 220-230V 50Hz Type	Link module Type	DIN-rail adapter Type
-	0.11- 0.16	J7MN-25-E16	J7KN-10-10 230	J74MN-VD-12	J74MN-HU
-	0.14- 0.2	J7MN-25-E2	J7KN-10-10 230	J74MN-VD-12	J74MN-HU
0.06	0.18- 0.25	J7MN-25-E25	J7KN-10-10 230	J74MN-VD-12	J74MN-HU
0.09	0.22- 0.32	J7MN-25-E32	J7KN-10-10 230	J74MN-VD-12	J74MN-HU
-	0.28- 0.4	J7MN-25-E4	J7KN-10-10 230	J74MN-VD-12	J74MN-HU
0.12	0.35- 0.5	J7MN-25-E5	J7KN-10-10 230	J74MN-VD-12	J74MN-HU
0.18	0.45- 0.63	J7MN-25-E63	J7KN-10-10 230	J74MN-VD-12	J74MN-HU
-	0.55- 0.8	J7MN-25-E8	J7KN-10-10 230	J74MN-VD-12	J74MN-HU
0.25	0.7- 1	J7MN-25-1	J7KN-10-10 230	J74MN-VD-12	J74MN-HU
0.37	0.9- 1.25	J7MN-25-1E25	J7KN-10-10 230	J74MN-VD-12	J74MN-HU
0.55	1.1- 1.6	J7MN-25-1E6	J7KN-10-10 230	J74MN-VD-12	J74MN-HU
0.75	1.4- 2	J7MN-25-2	J7KN-10-10 230	J74MN-VD-12	J74MN-HU
-	1.8- 2.5	J7MN-25-2E5	J7KN-10-10 230	J74MN-VD-12	J74MN-HU
1.1	2.2- 3.2	J7MN-25-3E2	J7KN-10-10 230	J74MN-VD-12	J74MN-HU
1.5	2.8- 4	J7MN-25-4	J7KN-10-10 230	J74MN-VD-12	J74MN-HU
-	3.5- 5	J7MN-25-5	J7KN-10-10 230	J74MN-VD-12	J74MN-HU
2.2	4.5- 6.3	J7MN-25-6E3	J7KN-10-10 230	J74MN-VD-12	J74MN-HU
3	5.5- 8	J7MN-25-8	J7KN-10-10 230	J74MN-VD-12	J74MN-HU
4	7- 10	J7MN-25-10	J7KN-10-10 230	J74MN-VD-12	J74MN-HU
5.5	9- 12.5	J7MN-25-12E5	J7KN-14-10 230	J74MN-VD-12	J74MN-HU
7.5	11- 16	J7MN-25-16	J7KN-18-10 230	J74MN-VD-12	J74MN-HU
-	14- 20	J7MN-25-20	J7KN-22-10 230	J74MN-VD-25	J74MN-HU
-	17- 22	J7MN-25-22	J7KN-22-10 230	J74MN-VD-25	J74MN-HU
11	20- 25	J7MN-25-25	J7KN-22-10 230	J74MN-VD-25	J74MN-HU

Technical Data according to IEC/EN 60947-1, 60947-2, 60947-4-1 and VDE 0660

This table shows the rated ultimate short-circuit breaking capacity I_{cu} and the rated service short-circuit breaking capacity I_{cs} of the J7MN circuit-breakers with different operational voltages as a function of the rated current I_n of the circuit-breakers.

The circuit-breakers can be fed at the top or bottom supply terminals without any reduction of the rated data.

If the short-circuit current exceeds the rated short-circuit breaking capacity of the circuit-breaker specified in the tables at the installation point, a back-up fuse is to be used.

The maximum rated current for the back-up fuse is specified in the tables. These fuses are only suitable for the short-circuit-currents as indicated on the fuses.

Circuit-breaker Type	Rated current I_n A	up to AC 240V ^{*1)}			up to AC 400V ^{*1)} up to AC 415V ^{*2)}			up to AC 440V ^{*1)} up to AC 460V ^{*2)}			up to AC 500V ^{*1)} up to AC 525V ^{*2)}			up to AC 690V ^{*1)}		
		I_{cu} kA	I_{cs} kA	max. fuse (gL/gG) A	I_{cu} kA	I_{cs} kA	max. fuse (gL/gG) A	I_{cu} kA	I_{cs} kA	max. fuse (gL/gG) A	I_{cu} kA	I_{cs} kA	max. fuse (gL/gG) A	I_{cu} kA	I_{cs} kA	max. fuse (gL/gG) A
J7MN-12	0.16 to 0.8	100	100	--	100	100	--	100	100	--	100	100	--	100	100	--
	1	100	100	--	100	100	--	100	100	--	100	100	--	100	100	--
	1.25	100	100	--	100	100	--	100	100	--	100	100	--	2	2	20
	1.6	100	100	--	100	100	--	100	100	--	100	100	--	2	2	20
	2	100	100	--	100	100	--	100	100	--	10	10	35	2	2	35
	2.5	100	100	--	100	100	--	100	100	--	10	10	35	2	2	35
	3.2	100	100	--	100	100	--	10	10	40	3	3	40	2	2	40
	4	100	100	--	100	100	--	10	10	40	3	3	40	2	2	40
	5	100	100	--	100	100	--	10	10	50	3	3	50	2	2	50
	6.3	100	100	--	100	100	--	10	10	50	3	3	50	2	2	50
	8	100	100	--	50	12.5	80 ^{*3)}	10	10	63	3	3	63	2	2	63
	10	100	100	--	50	12.5	80 ^{*3)}	10	10	63	3	3	63	2	2	63
	12	100	100	--	50	12.5	80 ^{*3)}	10	10	80	3	3	80	2	2	80
J7MN-25	0.16 to 1.25	100	100	--	100	100	--	100	100	--	100	100	--	100	100	--
	1.6	100	100	--	100	100	--	100	100	--	100	100	--	100	100	--
	2	100	100	--	100	100	--	100	100	--	100	100	--	8	8	25
	2.5	100	100	--	100	100	--	100	100	--	100	100	--	8	8	25
	3.2	100	100	--	100	100	--	100	100	--	100	100	--	8	8	32
	4	100	100	--	100	100	--	100	100	--	100	100	--	6	3	32
	5	100	100	--	100	100	--	100	100	--	100	100	--	6	3	32
	6.3	100	100	--	100	100	--	100	100	--	100	100	--	6	3	50
	8	100	100	--	100	100	--	50	25	63 ^{*3)}	42	21	63	6	3	50
	10	100	100	--	100	100	--	50	25	80 ^{*3)}	42	21	63	6	3	50
	12.5	100	100	--	100	100	--	50	25	80 ^{*3)}	42	21	80	6	3	63
	16	100	100	--	50	25	100 ^{*3)}	20	10	80	10	5	80	4	2	63
	20	100	100	--	50	25	125 ^{*3)}	20	10	80	10	5	80	4	2	63
	22	100	100	--	50	25	125 ^{*3)}	20	10	100	10	5	80	4	2	63
	25	100	100	--	50	25	125 ^{*3)}	20	10	100	10	5	80	4	2	63
J7MN-50	25	100	100	--	50	25	125 ^{*3)}	30	15	100	12	6	80	5	3	63
	32	100	100	--	50	25	125 ^{*3)}	30	15	125	10	5	100	4	2	63
	40	100	100	--	50	25	160 ^{*3)}	30	15	125	10	5	100	4	2	63
	45	100	100	--	50	25	160 ^{*3)}	30	15	125	10	5	100	4	2	63
	50	100	100	--	50	25	160 ^{*3)}	30	15	125	10	5	100	4	2	80
J7MN-100	63	100	100	--	50	25	160 ^{*3)}	40	20	160	12	6	125	6	3	80
	75	100	100	--	50	25	160 ^{*3)}	40	20	160	8	4	125	5	3	100
	90	100	100	--	50	25	160 ^{*3)}	40	20	160	8	4	125	5	3	125
	100	100	100	--	50	25	160 ^{*3)}	40	20	160	8	4	125	5	3	125

*1) 10% overvoltage

*2) 5% overvoltage

*3) Back-up fuse required if short-circuit current at installation point > 50 kA

-- No back-up fuse required.

Technical Data according to IEC/EN 60947-1, 60947-2, 60947-4-1 and VDE 0660

Main Circuit

Type		J7MN-12	J7MN-25	J7MN-50	J7MN-100		
Number of poles		3	3	3	3		
Max. rated current Inmax (=max. rated operational current Ie)	A	12	25	50	100		
Permissible ambient temperature							
Storage/transport	°C	-50 to +80					
Operation	°C	-20 to +70 ^{*1)}					
Permissible rated current at temperature inside cubicle of:	+60 °C	100					
	+70 °C	87					
Circuit-breaker inside enclosure							
	Permissible rated current at temperature inside enclosure of:						
	+60 °C	100					
	+70 °C	87					
Rated operational voltage Ue	V	690 ^{*2)}					
Rated frequency	Hz	50/60					
Rated insulation voltage Ui	V	690					
Rated impulse withstand voltage Uimp	kV	6					
Utilization category							
IEC 60 947-2 (circuit-breaker)		A					
IEC 60 947-4-1 (motor starter)		AC-3					
Class	acc. to IEC 60 947-4-1	10					
DC short-circuit breaking capacity (time constant t = 5 ms)							
1 conducting path DC 150 V	kA	10					
2 conducting paths in series DC 300 V	kA	10					
3 conducting paths in series DC 450 V	kA	10					
Power loss Pv per circuit-breaker dependent on rated current In (upper setting range)	In -> to 1.25 A	W	5	-	-	-	
	In -> 1.6 to 6.3 A	W	6	-	-	-	
	In -> 8 to 12 A	W	7	-	-	-	
	R per conducting path = P/(I ² × 3)	In -> 1 to 6.3 A	W	-	6	-	-
		In -> 8 to 16 A	W	-	7	-	-
		In -> 20 to 25 A	W	-	8	-	-
		In -> to 25 A	W	-	-	12	-
	In -> 32 A	W	-	-	15	-	
	In -> 40 to 50 A	W	-	-	20	-	
	In -> to 63 A	W	-	-	-	20	
In -> 75 to 90 A	W	-	-	-	30		
In -> to 100 A	W	-	-	-	38		
Shock resistance	acc. to IEC 68 Part 2-27	g	25	25	25	25	
Degree of protection	acc. to IEC 60 529		IP 20	IP 20	IP 20 ^{*3)}	IP 20 ^{*3)}	
Shock hazard protection	acc. to DIN VDE 0106 Part 100		safe against finger touch				
Temperature compensation	acc. to IEC 60 947-4-1	°C	-20 to +60				
Phase failure sensitivity	acc. to IEC 60 947-4-1		yes				
Explosion protection	acc. to EC Directive 94191 EC		yes ^{*4)}				
Isolator characteristics	acc. to IEC 60 947-3		yes				
Main and EM. STOP switch characteristics	acc. to IEC 60 204-1 (VDE 0113)		yes ^{*5)}				
Safe isolation between main and auxiliary circuits	acc. to DIN VDE 0106 Part 101						
	up to 400 V + 10 %		yes				
	up to 415 V + 5 %		yes				
Mechanical endurance	operating cycles		100 000	100 000	50 000	50 000	
Electrical endurance			100 000	100 000	25 000	25 000	
Max. operating frequency per hour (motor starts)	1/h		15	15	15	15	
Permissible mounting position		any. acc. to IEC 60 447 start command "I" right-hand side or top					

*1) Over +60°C current reduction
 *2) 500 V with moulded-plastic enclosure
 *3) Terminal compartment IP00
 *4) KEMA-test certification on request
 *5) With appropriate accessories

LVSG

Technical Data according to IEC/EN 60947-1, 60947-2, 60947-4-1 and VDE 0660

Conductor cross-sections for main Circuit

Type		J7MN-12	J7MN-25	J7MN-50	J7MN-100
Terminal type		Screw-type	Screw-type	Box terminal	Box terminal
Terminal screw		Pozidriv size 2	Pozidriv size 2	Pozidriv size 2	Allen screw 4 mm
Tightening torque	Nm	0.8 to 1.2	2 to 2.5	3 to 4.5	4 to 6
Conductor cross-sections					
solid	mm ²	2 x (0.5 to 1.5)	2 x (1 to 2.5)	2 x (0.75 to 16)	2 x (2.5 to 16)
	mm ²	2 x (0.75 to 2.5)	2 x (2.5 to 6)	—	—
	mm ²	1 x (0.5 to 4)	—	—	—
finely stranded with end ferrule	mm ²	2 x (0.5 to 1.5)	2 x (1 to 2.5)	2 x (0.75 to 16)	2 x (2.5 to 35)
	mm ²	2 x (0.75 to 2.5)	2 x (2.5 to 6)	1 x (0.75 to 25)	1 x (2.5 to 50)
	mm ²	—	1 x (1 to 10)	—	—
stranded	mm ²	2 x (0.5 to 1.5)	2 x (1 to 2.5)	2 x (0.75 to 25)	2 x (10 to 50)
	mm ²	2 x (0.75 to 2.5)	2 x (2.5 to 6)	1 x (0.75 to 35)	1 x (10 to 70)
	mm ²	1 x (0.5 to 4)	1 x (1 to 10)	—	—
AWG-wires, solid or stranded	AWG	2 x (18 to 14)	2 x (14 to 10)	2 x (18 to 3)	2 x (10 to 1/0)
	AWG	—	—	1 x (18 to 2)	1 x (10 to 2/0)
conductor bar (number x width x thick)	mm	—	—	2 x (6 x 9 x 0.8)	2 x (6 x 9 x 0.8)
	mm	—	—	—	18 x 10
	mm ²	—	—	—	up to 2 x 70

Technical Data according to IEC/EN 60947-1, 60947-2, 60947-4-1 and VDE 0660

Auxiliary switches

Switching capacity

Switching capacity				Control voltage			
Front transverse auxiliary switch with 1 NO + 1 NC							
Rated operational voltage U _e	AC	V	24	230			
Rated operational current I _e /AC-15		A	2	0.5			
Rated operational current I _e /AC-12 I _{th}		A	2.5	2.5			
Rated operational voltage U _e	DC L/R 200 ms	V	24	48	60		
Rated operational current I _e /DC-13		A	1	0.3	0.15		
Lateral auxiliary switch and signalling switch							
Rated operational voltage U _e	AC	V	24	230	400	690	
Rated operational current I _e /AC-15		A	6	6	3	1	
Rated operational current I _e /AC-12 I _{th}		A	10	10	10	10	
Rated operational voltage U _e	DC L/R 200 ms	V	24	110	220	440	
Rated operational current I _e /DC-13		A	2	0.5	0.25	0.1	
Undervoltage release							
Power consumption	during pick-up	VA/W	20.2/13				
	uninterrupted duty	VA/W	7.2/2.4				
Response voltage	trip	V	0.7 to 0.35 × U _s				
	pick-up	V	0.85 to 1.1 × U _s				
Max. opening time		ms	20				
Shunt release							
Power consumption during pick-up		AC VA/W	20.2/13				
		DC W	13 to 80				
Response voltage acc. to IEC 60 947-1, trip		V	0.7 to 1.1 × U _s				
Max. opening time		ms	20				
Short-circuit protection for auxiliary and control circuits							
Fuse	gL/gG	A	10				
Miniature circuit breaker C-characteristic		A	6 ^{*1})				
Conductor cross-sections for auxiliary and control circuits							
solid		mm ²	2 x (0.5 to 1.5) / 2 x (0.75 to 2.5)				
finely stranded with ferrule		mm ²	2 x (0.5 to 1.5) / 2 x (0.75 to 2.5)				
stranded		mm ²	2 x (0.5 to 1.5) / 2 x (0.75 to 2.5)				
AWG-wires, solid or stranded		AWG	2 x (18 to 14)				

*1) Prospective short-circuit current < 0.4 kA.

Description

J7MN circuit-breakers are compact, current-limiting circuit-breakers which are optimised for load feeders. The circuit-breakers are used for switching and protecting three-phase induction motors of up to 18,5 kW at AC 400 V and for loads with rated currents of up to 40 A.

Construction

The circuit-breakers are available in three sizes:

J7MN-12 overall width 45 mm. Max. rated current 12 A. Suitable for 3-phase induction motors of up to 5.5 kW at voltages of 400 V AC.

J7MN-25 overall width 45 mm. Max. rated current 25 A. Suitable for 3-phase induction motors of up to 11 kW at voltages of 400 V AC.

J7MN-50 overall width 55 mm. Max. rated current 40 A. Suitable for 3-phase induction motors of up to 18,5 kW at voltages of 400 V AC.

Releases

Circuit-breakers J7MN are equipped with bimetallic-based, inverse-time delayed overload releases and with instantaneous overcurrent releases (electromagnetic short-circuit releases).

The overload releases can be set in accordance with the load current. The overcurrent releases are permanently set to a value 13 times the rated current and thus enable trouble-free start-up of motors.

The scale cover can be sealed to prevent unauthorized adjustments to the set current.

Operating mechanisms

circuit-breakers J7MN-12 are actuated via a switch operating mechanism and circuit-breakers J7MN-25 and J7MN-50 via a rotary operating mechanism. If the circuit-breaker trips, the rotary operating mechanism switches to the tripped position to indicate this. Before the circuit-breaker is reclosed, the rotary operating mechanism must be reset to the 0 position by hand, in order to prevent the former from closing by mistake before the fault has been cleared.

In the case of circuit-breakers with rotary operating mechanisms, there is an electrical signal via a signalling switch to indicate that the circuit-breaker has tripped.

All operating mechanisms can be locked in the 0 position with a padlock (shackle diameter 3.5 to 4.5 mm).

The J7MN circuit-breakers fulfil the isolation characteristics specified in IEC 60 947-2.

Operating conditions

Circuit-breakers J7MN are suitable for use in any climate. They are designed for operation in enclosed rooms under normal conditions (e. g. no dust, corrosive vapours or harmful gases). Suitable enclosures must be provided for installation in dusty or damp rooms.

Circuit-breakers J7MN can also be fed from below. The standards in accordance with which the circuit-breakers are constructed, the permissible ambient temperatures, the maximum making and breaking capacities, the tripping currents and other boundary conditions can be found in the technical data and tripping characteristics.

Since the operational currents, starting currents and current peaks vary as a result of the inrush current, even in the case of motors with identical output ratings, the values specified for these output ratings in the selection tables are intended as a guide only. The specific rated and start-up data of the motor to be protected is always paramount to the choice of the most suitable circuit-breaker.

In order to prevent premature tripping due to phase failure sensitivity, the circuit-breakers should always be connected in such a way that current flows through all three main conducting paths.

Short-circuit protection

The short-circuit releases of J7MN circuit-breakers disconnect the faulty load feeder from the system in the event of a short circuit and thus prevent any further damage.

Circuit-breakers with a short-circuit breaking capacity of 50 kA or 100 kA at a voltage of 400 V AC are practically short-circuit-proof at this voltage, as higher short-circuit currents are not usually encountered at the installation point.

Back-up fuses are only necessary if the short-circuit current at the installation point exceeds the rated ultimate short-circuit breaking capacity of the circuit-breakers.

Motor protection

The tripping characteristics of J7MN circuit-breakers are designed mainly to protect three-phase induction motors. The circuit-breakers are therefore also referred to as motor circuit-breakers. The current of the motor to be protected is set with the aid of the scale.

Circuit-breakers with thermal overload releases are normally designed in accordance with release Class 10.

Line protection

J7MN circuit-breakers for motor protection are also suitable for line protection. In order to prevent premature tripping due to phase failure sensitivity, the three conducting paths must always be uniformly loaded. The conducting paths must be connected in series in the case of single-phase loads.

The J7MN circuit-breakers meet the isolation conditions of IEC 60 947-3 as well as the additional test conditions for circuit-breakers with isolation characteristics specified in IEC 60 947-2. Taking IEC 60 204-1 into consideration, they can thus be implemented as main and EMERGENCY STOP switches.

Door-coupling rotary operating mechanism do not fulfil the isolation characteristics specified in IEC 60 947-2. Door-coupling rotary operating mechanism according isolation characteristics specified in IEC 60 947-2 on request.

Characteristics

The time/current characteristic, the current limiting characteristics and the I^2t characteristics were determined in accordance with DIN VDE 0660 and IEC 60 947.

The tripping characteristic of the inverse-time delayed overload releases (thermal overload releases or 'a' releases) for DC and AC with a frequency of 0 to 400 Hz also apply to the time/current characteristic.

The characteristics apply to the cold state. At operating temperature, the tripping times of the thermal releases are reduced to approximately 25 %.

Under normal operating conditions, all three poles of the device must be loaded. The three main conducting paths must be connected in series in order to protect single-phase or DC loads.

With 3-pole loading, the maximum deviation in the tripping time for 3 times the setting current and upwards is $\pm 20\%$ and thus in accordance with DIN VDE 0165.

The tripping characteristics for the instantaneous, electromagnetic overcurrent releases (short-circuit releases or 'n' releases) are based on the rated current I_n , which is also the maximum value of the setting range for circuit-breakers with adjustable overload releases. If the current is set to a lower value, the tripping current of the 'n' release is increased by a corresponding factor.

The characteristics of the electromagnetic overcurrent releases apply to frequencies of 50/60 Hz. Appropriate correction factors must be used for lower frequencies up to $16\frac{2}{3}$ Hz, for higher frequencies up to 400 Hz and for DC.

The characteristic shown here is a schematic representation of circuit-breakers for all ranges.

Time/current characteristics, current limiting characteristics and I^2t characteristics are available on request.

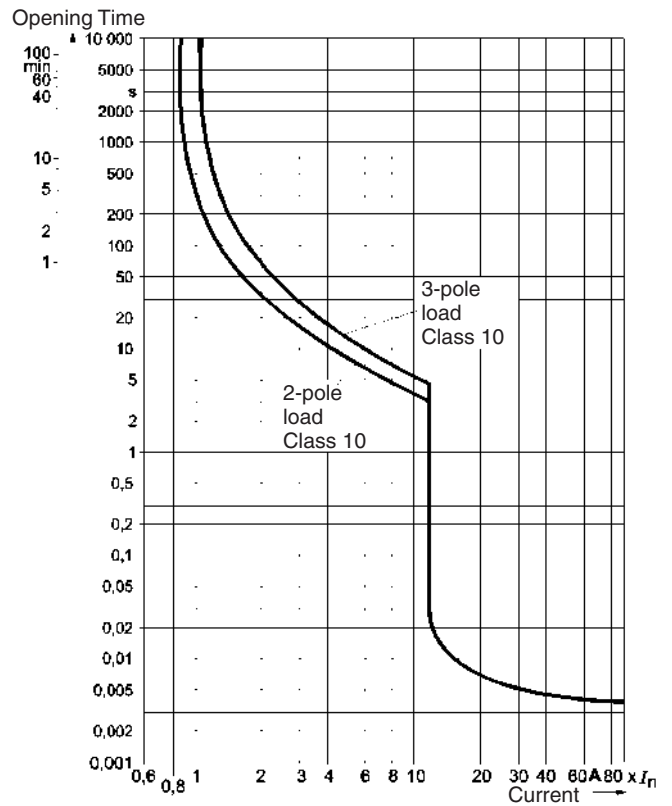

Wiring diagrams

<p>Circuit-breaker J7MN</p>	<p>Transverse auxiliary contact block J73MN-11F</p>	<p>Lateral auxiliary contact block J73MN-11S</p>
<p>Signalling switch J73MN-T-11S</p>	<p>Undervoltage release J74MN-U</p>	<p>Shunt release J74MN-S</p>

■ Dimensions

Circuit-breaker J7MN-12

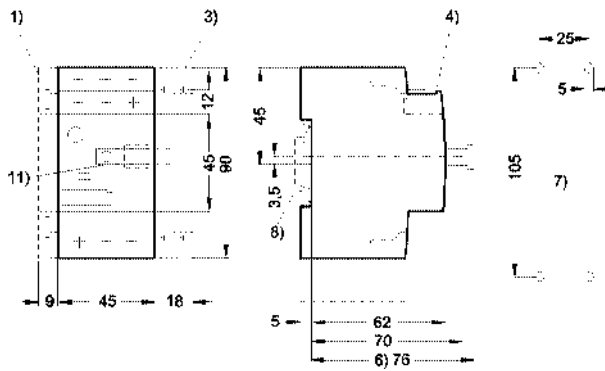

Circuit-breaker J7MN-25

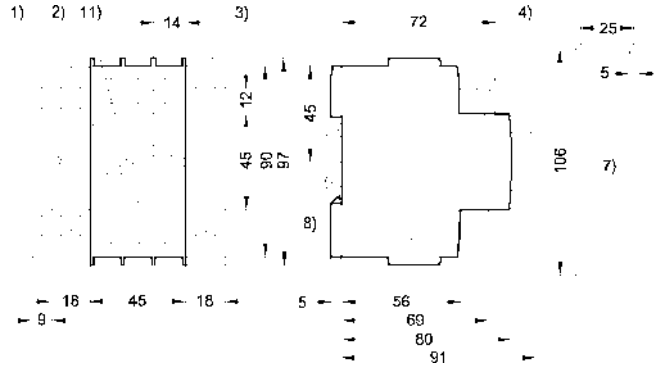

Circuit-breaker J7MN-50

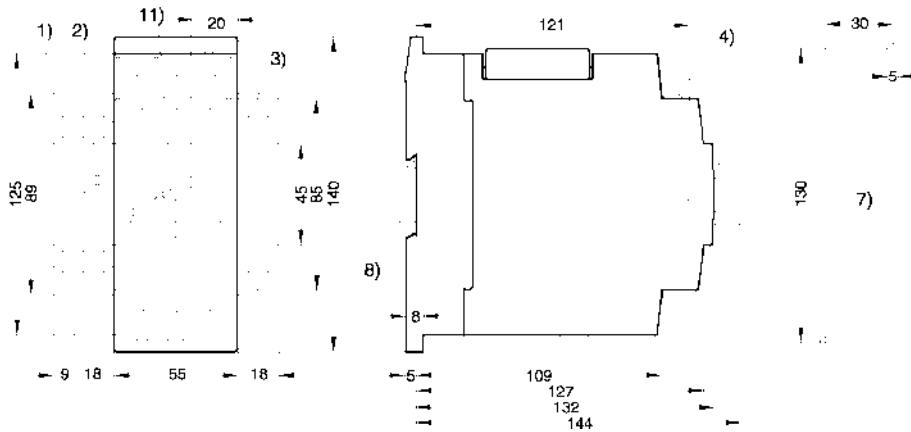

- 1) Lateral aux. contact
- 2) Signalling contact
- 3) Auxiliary release
- 4) Transverse aux. contact
- 7) Mounting holes
- 8) 35mm DIN-rail
- 9) 35mm DIN-rail 15mm high or 75mm DIN-rail
- 10) 4mm hexagon socket screw
- 11) Lockable in 0-position with shackle diameter max.5mm

Circuit-breaker J7MN-100

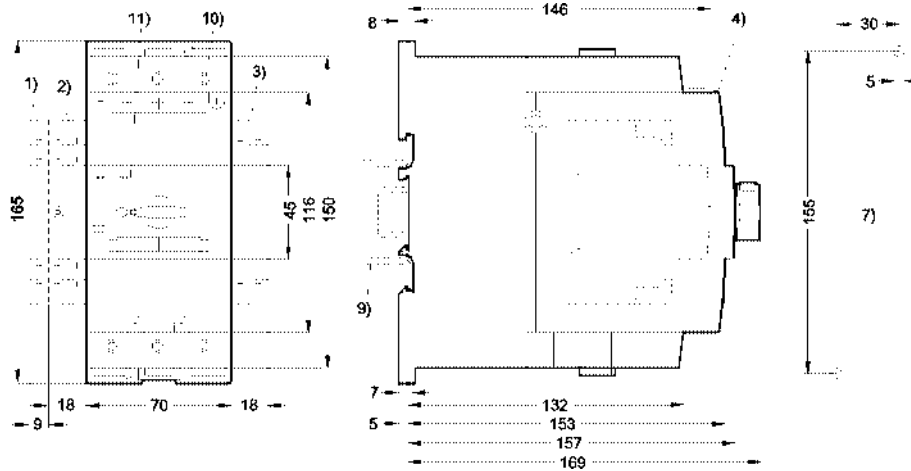

- 1) Lateral aux. contact
- 2) Signalling contact
- 3) Auxiliary release
- 4) Transverse aux. contact
- 7) Mounting holes
- 8) 35mm DIN-rail
- 9) 35mm DIN-rail 15mm high or 75mm DIN-rail
- 10) 4mm hexagon socket screw
- 11) Lockable in 0-position with shackle diameter max.5mm

LVSG

Moulded plastic front plate **J74MN-P12**

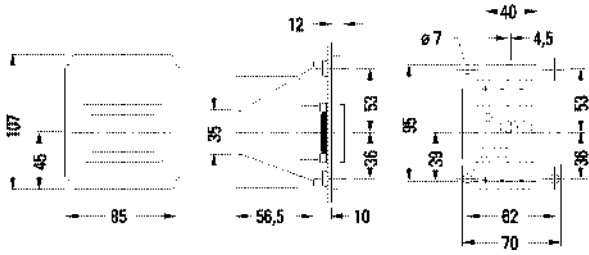

Moulded plastic front plate **J74MN-P25**

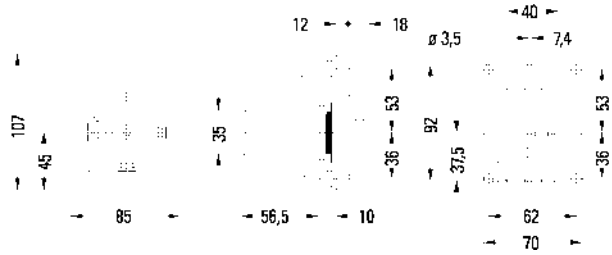

Moulded plastic enclosure **J74MN-PF12**

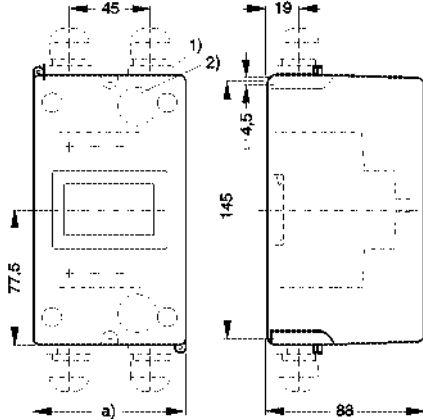

Door-coupling rotary operating mechanism **J74MN-DC**

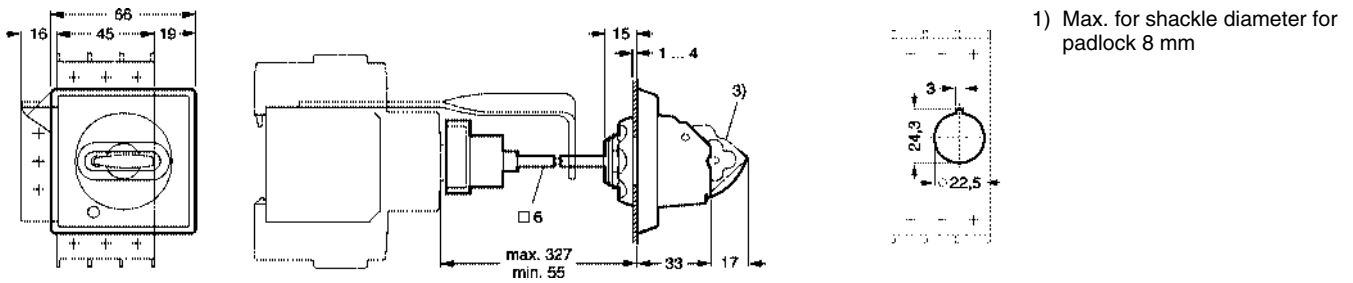

3-phase busbar **J74MN-L3-□/□**
for J7MN-12 and J7MN-25, modular spacing 45 mm

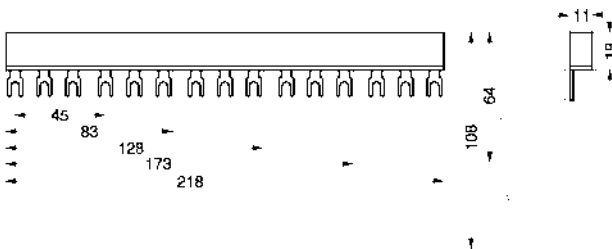

3-phase line-side terminal **J74MN-TC12** and **J74MN-TC25**

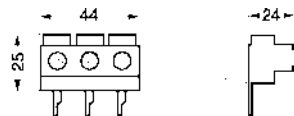

ALL DIMENSIONS SHOWN ARE IN MILLIMETERS.

Appendix

● Precautions

■ Notice

Use under rated condition, otherwise contactors will not only cause malfunction, but also cause a fire or damage the contactor.

Life period of contactor depends on the operating application. Please check the electrical life under real application in advance.

If you continue to use malfunctioning contactor, a fire or breakdown may occur.

Do not miss-wire or miss-charge the power supply, otherwise the contactor does not work correctly.

Do not operate in places with explosive or flammable gas, otherwise a fire or explosion may occur by arc or heating from contactor.

Make sure to use the circuit well considered about safety, in case there is any possibility to cause secondary disaster by contact trouble (welding, faulty contact).

Do not supply short-circuit current to electromagnetic switch (contactor with thermal relay). Doing so may result failure in heater of thermal relay. Please use short-circuit protection like fuse or protective circuit breaker.

Do not use a contactor or thermal relay which has been dropped or dismantled. Doing so may cause malfunction or a fire.

Make sure to shut off power supply to contactors before wiring or replacing.

Do not operate the actuator of a contactor manually. Doing so may cause contact welding by chattering or burn out by arc.

Unless otherwise stated in the catalogue, modifications, especially those of stated values, sizes and weights are subject to alternation.

Diagrams and tables are subject to alternation and not to be regarded as binding drawings.

■ Correct use

General use

Unexpected malfunction may occur in real application. Please carry out as many tests as possible.

Ratings in this catalogue measured under the condition according to IEC unless otherwise specified. In cases of check by real application, please carry out the test under the same condition as expected in the actual application.

Selection

Coil specification

Please select suitable coil to circuit design, otherwise malfunction may occur or coil may have a burn out by overvoltage etc.

Type

Please check contact ratings, switching capacity, thermal characteristics etc. when selecting product type.

Thermal relay

Motor current differs by supplier, type, number of poles, frequency. Please confirm operational current level.

Coil surge suppressor

Coil surge suppressor type should be selected by contactor type, auxiliary relay type and applied voltage. Make sure to use defined each contactor.

In case of installing coil surge suppressor, please check the actual circuit because the release time will be delayed.

Electrical life expectancy

Electrical life expectancy tests in this catalogue are based on IEC.

Circuit design

Supplied voltage waveform for input

Make sure to apply and remove the voltage instantly. Do not use under the condition that the coil voltage waveform increases or decreases gradually.

In case of DC contactor use (input voltage ripple)

Please use DC contactor input voltage with a ripple ratio less than 5%. Excessive ripple (pulsating current) may cause contact welding.

Fluctuation of input voltage

Make sure to supply sufficient voltage to actuate contactors properly. Continuous supply of insufficient voltage results in excessive heating and may cause burn out of coil.

Maximum applied voltage

Do not supply the voltage over the maximum rated voltage, otherwise burn out or insulation failure may occur.

The temperature inside control panel has much influence to the coil temperature, so make sure not to exceed the specified value in the catalogue.

Basically rated voltage should be supplied to coil. To supply higher voltage than rated would result in shorter electrical life, even if it is lower than the maximum rated voltage.

Reverse

Make sure to use reversible contactors for reverse operation.

Make sure to use interlock device in reverse operation by two contactors, otherwise short circuit current may burn out or give damage to contactors and motors.

Installation

Mounting

Make sure to use specified wire size, mounting screw size, mounting screw number, and DIN rail size.

Tightening Screw

Tighten each screw securely by specified tightening torque. Loose tightening may cause a fire by excessive heating.

Combination

Please use only OMRON product combinations in case of thermal relay, timer block and auxiliary contact block etc.

Wrong-combinations may result in damage to contactors.

Mounting direction

Some products have a defined specific mounting direction. Please refer to datasheet before use.

Operation ambience

Dust

Dust on the surface of the contacts could result in contact malfunctioning. Take countermeasure in excessive dusty surrounding.

Temperature, humidity

Use contactors within the temperature and humidity conditions specified in datasheet. To use or store contactor in excessive temperature or humidity may result in malfunction of contact by organic film composed by sulfication and oxidation on the surface of the contacts.

Use contactors within the temperature and humidity conditions specified in the datasheet, to prevent contactors from insulation resistance failure by condensation or insulation resistance deterioration by tracking.

Gas

NH₃, H₂S, SO₂, Cl₂, Si and NO₂ have bad effects on a contactor.

With these gases, a corrosive metal film is generated on the surface of the contacts and could result in contact malfunctioning. Use a contactor in low humidity and no corrosive gas surroundings.

Oil

Do not use a contactor in places where oil is sprayed onto the contactor. It will cause cracks on polymer parts.

Shock and vibration

Do not use a contactor in places where there is excessive shock or vibration. It may cause malfunctioning.

Storage

Store contactors in a place with no direct sunshine or ultraviolet rays. It will cause crack on polymer parts.

When contactors are to be stored for a long time, they must be stored with care. Though it generally depends where contactors are stored, deterioration of contacts may occur after long storage. Please check the characteristics before use after long time storage.

● European Standards

■ IEC 947, EN 60947

European Standards for Low-Voltage Switchgear

For Europe and most other industrial countries of the world, the new IEC 947 and EN 60 947 specifications for low-voltage switchgear have unified the regulations which previously varied from nation to nation.

This required the introduction of new terms, and new test methods and utilization categories. The new specifications are aimed primarily at manufacturers. However, the user also will come across new technical terms and data in the manufacturers' catalogues and on the devices themselves which are important for the selection and application of the devices. The present paper deals with the currently published specifications. Further specifications and supplements are in preparation.

Since 1993, all low-voltage switchgear purchased in Europe had to satisfy the EN 60 947 European Standard. Installations in existence prior to 1993 are not affected by the standard and need not to be refitted with new devices. Devices constructed and tested to the IEC standards and EN standards can be used worldwide, with the exception of the USA and Canada. In these countries UL and CSA specifications continue to apply. Switchgear which conforms to IEC 947 and EN 60 947 and which has, in addition, UL- and CSA approvals, in the meantime has entered the market. Such 'world market' devices offer the advantage that they can be used throughout the world, including the USA and Canada.

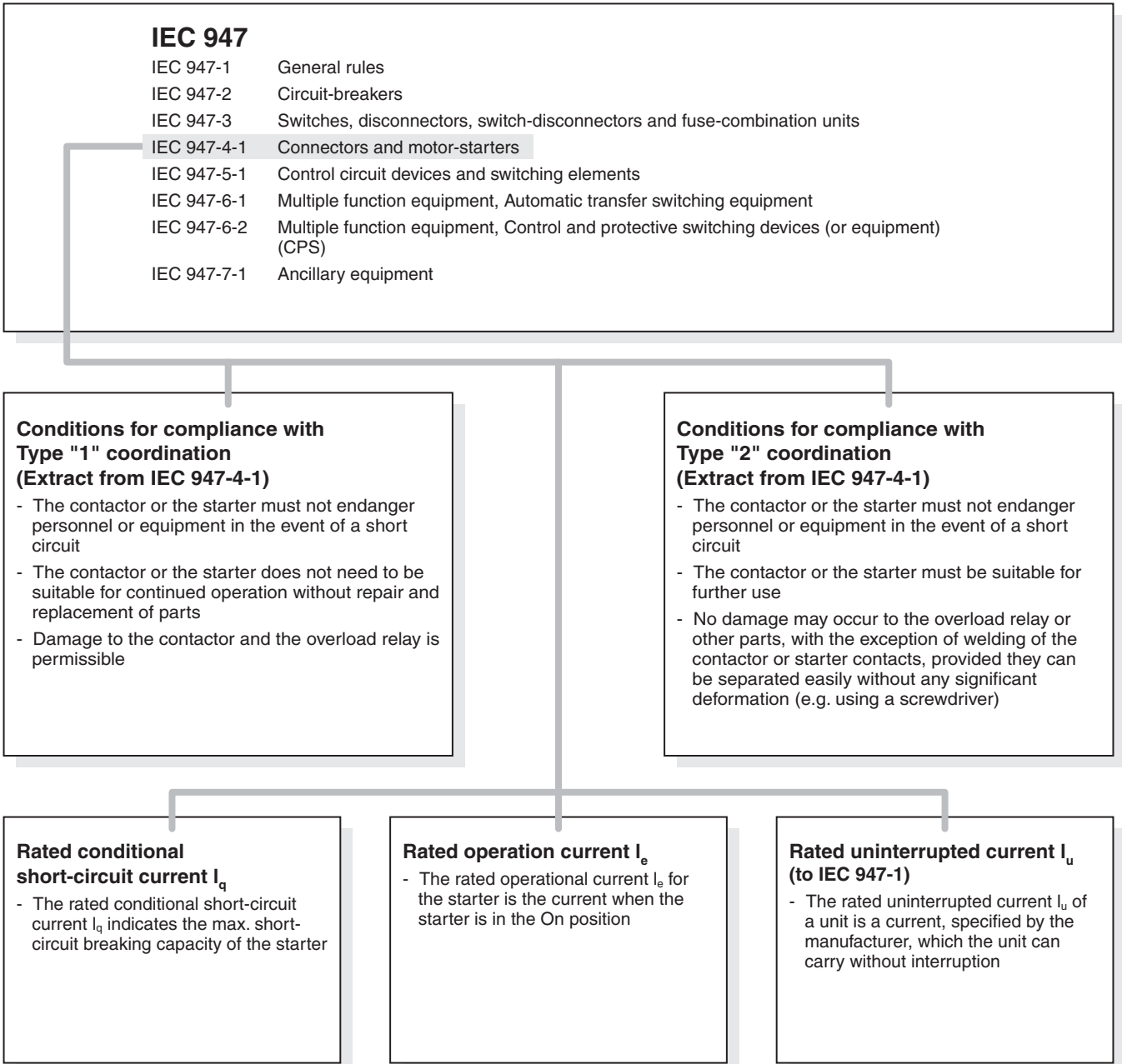

LVSG

Overview

The following table shows in summarized form both the previous and the new IEC, EN and DIN VDE standards.







Previous specification		New specification		Content
IEC	DIN VDE	IEC	EN 60947 DIN VDE	
-	-	947-1	60947-1 0660, Part 100	Low-voltage switchgear, General rules
157	0660, Part 101	947-2	60947-2 0660, Part 101	Low-voltage switchgear, Circuit-breakers
406	0660, Part 107	947-3	60947-3 0660, Part 107	Low-voltage switchgear, Switches, Disconnectors, Switch-disconnectors, Fuse-combination units
158 292-1 292-2 292-3	0660, Part 102 0660, Part 104 0660, Part 106 0660, Part 301	947-4-1	60947-4-1 0660, Part 102	Low-voltage switchgear, Control circuit devices and switching elements
337	0660 Part 200 to Part 205	947-5-1	60947-5-1 0660, Part 200	Low-voltage switchgear, Multiple-function equipment, Automatic transfer switching equipment
-	-	947-6-1	60947-6-1 0660, Part 114	Low-voltage switchgear, Multiple-function equipment, Control and protective switching devices (CPS)
-	0611 Part 1 and 2	947-7-1	60947-7-1 0611, Part 1	Low-voltage switchgear, Ancillary equipment (e.g. terminal blocks)

Switches, disconnectors, switch-disconnectors and fuse combination units (IEC 947-3, EN 60947-3)

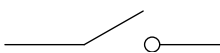
These devices must now be labelled with the product function designated by the manufacturer. This means placing clearly visible symbols on the device itself.

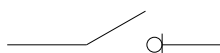
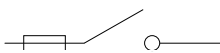
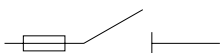
Devices with an isolating function are subject to special safety requirements. They must for example have greater creepage distances and clearances across the opened contacts than is necessary for other devices.

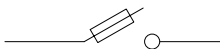
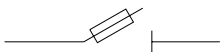
Device functions and corresponding symbols

Making/breaking	Isolating	Making/breaking + isolating
Switch 	Disconnector 	Switch-disconnector 
Switch-fuse 	Disconnector-fuse 	Switch-disconnector-fuse 
Fuse-switch 	Fuse-disconnector 	Fuse switch-disconnector 

OMRON equipment is designed for the world's markets

It is manufactured and tested in accordance with national and international specifications, the most important of which are listed below:

IEC 947-..., EN 60947:	Low-voltage switch gear and control gear
IEC 664:	Insulation co-ordination including clearances and creepage distances for equipment
IEC364:	Electrical installations of buildings
IEC 204-..., EN 60204-...:	Electrical equipment of industrial machines
DIN VDE 0105:	Operation of electrical power installations
IEC 536:	Protection against electric shock

Utilization categories for contactors to IEC 947-4-1 and EN 60947

Type of current	Utilization category	Typical examples of application I = current made, I _c = current broken I ₀ = rated operational current U = voltage before make U ₀ = rated operational voltage U _r = recovery voltage	Verification of electrical endurance						Verification of rated making and breaking capacities							
			Make			Break			Make			Break				
			I ₀ A	I - I ₀	U - U ₀	cos φ	I _c - I ₀	U _r - U ₀	cos φ	I ₀ A	I - I ₀	U - U ₀	cos φ	I _c - I ₀	U _r - U ₀	cos φ
AC	AC-1	Non-inductive or slightly inductive loads, resistance furnaces	All values	1	1	0.95	1	1	0.95	All values	1.5	1.05	0.8	1.5	1.05	0.8
	AC-2	Slip-ring motors: starting, switching off	All values	2.5	1	0.65	2.5	1	0.65	All values	4	1.05	0.65	4	1.05	0.65
	AC-3	Squirrel-cage motors: starting, switching off motors during running ⁴	I ₀ ≤ 17 I ₀ > 17	6 6	1 1	0.65 0.35	1 1	0.17 0.17	0.65 0.35	I ₀ ≤ 100 I ₀ > 100	10 10	1.05 1.05	0.45 0.35	8 8	1.05 1.05	0.45 0.35
	AC-4	Squirrel-cage motors: starting, plugging, inching	I ₀ ≤ 17 I ₀ > 17	6 6	1 1	0.65 0.35	6 6	1 1	0.65 0.35	I ₀ ≤ 100 I ₀ > 100	12 12	1.05 1.05	0.45 0.35	10 10	1.05 1.05	0.45 0.35
	AC-5A	Switching of electric discharge lamp controls	-	-	-	-	-	-	-	-	3.0	1.05	0.45	3.0	1.05	0.45
	AC-5B	Switching of incandescent lamps	-	-	-	-	-	-	-	-	1.5 ²	1.05 ²	2)	1.5 ²	1.05 ²	2)
	AC-6A ³	Switching of transformers	As given by the manufacturer						-							
	AC-6B ³	Switching of capacitor banks	As given by the manufacturer						-							
	AC-7A	Slightly inductive loads in household appliances and similar applications	As given by the manufacturer						-							
	AC-7B	Motor-loads for household applications	As given by the manufacturer						-							
AC-8A	Hermetic refrigerant compressor motor control with manual resetting of overload releases ⁵	As given by the manufacturer						-								
AC-8B	Hermetic refrigerant compressor motor control with automatic resetting of overload releases ⁵	As given by the manufacturer						-								

			I ₀	I	U	L/R	I _c	U _r	L/R	I ₀	I	U	L/R	I _c	U _r	L/R
			A	- I ₀	- U ₀	ms	- I ₀	- U ₀	ms	A	- I ₀	- U ₀	ms	- I ₀	- U ₀	ms
DC	DC-1	Non-inductive or slightly inductive loads, resistance furnaces	All values	1	1	1	1	1	1	All values	1.5	1.05	1	1.5	1.05	1
	DC-3	Shunt motors: starting, plugging, inching, dynamic braking	All values	2.5	1	2	2.5	1	2	All values	4	1.05	2.5	4	1.05	2.5
	DC-5	Series motors: starting, plugging, inching, dynamic braking	All values	2.5	1	7.5	2.5	1	7.5	All values	4	1.05	15	4	1.05	15
	DC-6	Switching of incandescent lamps	-	-	-	-	-	-	-	-	1.5 ²	1.05 ²	2)	1.5 ²	1.05 ²	2)

- Note 1:** cos φ = 0.45 for I₀ ≤ 100 A; cos φ = 0.35 for I₀ > 100 A.
2: The tests are to be carried out with an incandescent light load.
3: The test data are to be derived from the test values for AC-3 or AC-4 according to Table VIIb, EN 60947-4-1.
4: AC-3 category may be used for occasional inching (jogging) or plugging for limited time periods such as machine set-up; during such limited time periods the number of such operations should not exceed five per minute or more than ten in a ten minute period.
5: A hermetic refrigerant compressor motor is a combination consisting of a compressor and a motor, both of which are enclosed in the same housing, with no external shaft or shaft seals, the motor operating in the refrigerant.

Utilization categories for control switches to IEC 947-5-1 and EN 60947

Type of current	Utilization category	Typical examples of application I = current made, I _c = current broken I ₀ = rated operational current U ₀ = rated operational voltage U _r = recovery voltage U = voltage before make t _{0.95} = time in ms to reach 95 % of the steady-state current P = U ₀ × I ₀ = rated power consumption in watts	Normal conditions of use						Abnormal conditions of use						
			Make			Break			Make			Break			
			I ₀	I	U	cos φ	I _c	U _r	cos φ	I ₀	I	U	cos φ	I _c	U _r
AC	AC-12	Control of resistive and solid state loads as in opto-coupler input circuits	1	1	0.9	1	1	0.9	-	-	-	-	-	-	-
	AC-13	Control of solid state loads with transformer isolation	2	1	0.65	1	1	0.65	10	1.1	0.65	1.1	1.1	0.65	
	AC-14	Control of small electromagnetic loads (≤ 72 VA)	6	1	0.3	1	1	0.3	6	1.1	0.7	6	1.1	0.7	
	AC-15	Control of electromagnetic loads (> 72 VA)	10	1	0.3	1	1	0.3	10	1.1	0.3	10	1.1	0.3	

			I	U	t _{0.95}	I _c	U _r	t _{0.95}	I	U	t _{0.95}	I _c	U _r	t _{0.95}
			- I ₀	- U ₀	ms	- I ₀	- U ₀	ms	- I ₀	- U ₀	ms	- I ₀	- U ₀	ms
DC	DC-12	Control of resistive and solid state loads as in opto-coupler input circuits	1	1	1 ms	1	1	1 ms	-	-	-	-	-	-
	DC-13	Control of electromagnets	1	1	6xP ¹)	1	1	6xP ¹)	1.1	1.1	6xP ¹)	1.1	1.1	6xP ¹)
	DC-14	Control of electromagnetic loads having economy resistors in circuits	10	1	15 ms	1	1	15 ms	10	1.1	15 ms	10	1.1	15 ms

- Note 1:** The value "6 x P" results from an empirical relationship which is found to represent most DC magnetic loads to an upper limit of P = 50 W, viz 6 x P = 300 ms. Loads having power consumption greater than 50 W are assumed to consist of smaller loads in parallel. Therefore, 300 ms is to be an upper limit, irrespective of the power consumption value.

Utilization categories for switches, disconnectors, switch-disconnectors, and fuse combination units to IEC 947-3 and EN 60947

Type of current	Utilization category	Typical applications I = current made, I _c = current broken I ₀ = rated operational current U = voltage before make U ₀ = rated operational voltage U _r = recovery voltage	Verification of electrical endurance						Verification of switching capacity							
			Make			Break			Make			Break				
			I ₀	I	U	cos φ	I _c	U _r	cos φ	I ₀	I	U	cos φ	I _c	U _r	cos φ
AC	AC-20 A(B) ²	Connecting and disconnecting under no-load conditions	All values	1)	1)	1)	1)	1)	1)	All values	1)	1.05	1)	1)	1.05	1)
	AC-21 A(B) ²	Switching of resistive loads, including moderate overloads	All values	1	1	0.95	1	1	0.95	All values	1.5	1.05	0.95	1.5	1.05	0.95
	AC-22 A(B) ²	Switching of mixed resistive and inductive loads, including moderate overloads	All values	1	1	0.8	1	1	0.8	All values	3	1.05	0.65	3	1.05	0.65

Utilization categories for switches, disconnectors, switch-disconnectors, and fuse combination units to IEC 947-3 and EN 60947																
Type of current	Utilization category	Typical applications I = current made, I _c = current broken I _o = rated operational current U = voltage before make U _o = rated operational voltage U _r = recovery voltage	Verification of electrical endurance									Verification of switching capacity				
			Make				Break					Make				Break
			I _o	I _r	U _o	cos φ	I _c	U _r	cos φ	I _o	I _r	U _o	cos φ	I _c	U _r	cos φ
A	I _o	U _o		I _o	U _o		A	I _o	U _o		I _o	U _o				
	AC-23 A(B) ²	Switching of motor loads or other highly inductive loads	All values	1	1	0.65	1	1	0.65	I _o ≤ 100 I _o > 100	10 10	1.05 1.05	0.45 0.35	8 8	1.05 1.05	0.45 0.35

			I _o	I _r	U _o	L/R	I _c	U _r	L/R	I _o	I _r	U _o	L/R	I _c	U _r	L/R
			A	I _o	U _o	ms	I _o	U _o	ms	A	I _o	U _o	ms	I _o	U _o	ms
DC	DC-20 A(B) ²	Connecting and disconnecting under no-load conditions	All values	1 ¹⁾	1 ¹⁾	1 ¹⁾	1 ¹⁾	1 ¹⁾	1 ¹⁾	All values	1 ¹⁾	1.05	1 ¹⁾	1 ¹⁾	1.05	1 ¹⁾
	DC-21 A(B) ²	Switching of resistive loads, including moderate overloads	All values	1	1	1	1	1	1	All values	1.5	1.05	1	1.5	1.05	1
	DC-22 A(B) ²	Switching of mixed resistive and inductive loads, including moderate overloads (e.g. shunt motors)	All values	1	1	2	1	1	2	All values	4	1.05	2.5	4	1.05	2.5
	DC-23 A(B) ²	Switching of highly inductive loads (e.g. series motors)	All values	1	1	7.5	1	1	7.5	All values	4	1.05	15	4	1.05	15

Note 1: If the switching device has a making and/or breaking capacity, the figures for the current and the power factor (time constants) must be stated by the manufacturer.
2: A: frequent operation, B: infrequent operation.

Protection against electrical shock, to IEC 536

IEC 536 covers the setting up of electrical apparatus, and its arrangement in electrical installations with rated voltages up to 1000 VAC and 1500 VDC, with regard to protection against direct contact where operating elements such as push-buttons and switches are located in the vicinity of live parts.

“Finger-proofing” relates only to the operating device, and only in the normal direction of operation. A clearance of at least 30 mm radius from the centre point of the device to any live parts, must be ensured.

The IP 20 degree of protection is superior to “finger-proofing” in that it embodies protection against contact with electrical apparatus in any direction. Devices which are “finger-proof” and of IP 00 degree of protection can be provided with further protection against contact in the form of shrouding, if so desired.

Damp heat, constant, to IEC 68 Part 2-3

In this test, the effects of a constant high level of humidity (93 +2/-3%) and a constant temperature (40 ±2)°C over a prescribed duration, are observed.

Damp heat, cyclic, to IEC 68 Part 2 - 30, Test Db

This test is used to assess the suitability of electrical products for operation and storage at high relative humidity levels, in conjunction with cyclic temperature fluctuation. A test cycle consists of 12 hours at 40 ±2°C, with relative humidity of 93 ±3%, and 12 hours at 25 ±3°C, with the relative humidity of at least 95%.

Ambient temperature

Ambient temperature is the temperature of the room (e.g. factory bay or switchgear room), in which the open or enclosed device is installed, a prerequisite being that this temperature is not significantly influenced by the heat losses from the device.

● Glossary of standard terms

This Glossary offers brief explanations of some of the standard terms used in this catalogue. However, it must not be regarded as a substitute for the actual text of the standard, especially where the new terms used in IEC 947 are concerned.

Reference is therefore made alongside each such term to the relevant section of the standard, e.g. IEC 947-1 in addition, IEC numbers are given to enable you to find foreign language equivalents in the International Electrotechnical Vocabulary (IEV 50), if required.

Rated conditional short-circuit current I_q (IEC 947-1; 2.5.29/IEV 441-17-20)

The prospective current which a switching device, e.g. a circuit-breaker, protected by a short-circuit protective device such as a motor-protective circuit-breaker, can carry for the duration of the protective device tripping time.

Minimum command time

Minimum duration for a trip-initiating factor (control pulse, short circuit) to effect the corresponding reaction, e.g. the short-circuit duration necessary to initiate tripping.

Rated breaking capacity (IEC 947-1; 4.3.5.3)

The r.m.s. value of current which a switching device is capable of breaking according to its utilization category. The rated breaking capacity is stated by reference to the rated operational voltage and the rated operational current.

The equipment must be capable of breaking any value of current up to and including its rated breaking capacity stated.

Rated actuating voltage U_c (rated control circuit voltage) (IEC 947-1; 4.5.1)

The voltage which is applied to the actuating make contact in a control circuit. Due to the presence in the control circuit of transformers or resistors, this voltage may differ from the rated control supply voltage.

Rated service short-circuit breaking capacity I_{cs} (IEC 947-2; 4.3.5.2.2)

The prospective short-circuit current which, depending on the rated operational voltage, a circuit-breaker is capable of breaking repeatedly (test cycle: O - CO - CO; previously P-2). After interrupting this current value, the circuit-breaker must be capable, despite its own thermal level having increased, of continuing to carry and disconnect in the event of overloading, the rated uninterrupted current.

Rating or rated power (IEC 947-1; 4.3.2.3)

The rated operational power which an equipment is capable of switching at the associated rated operational voltage in accordance with the utilization category.

For example:
motor contactor utilization category AC-3: 37 kW at 400 V.

Rated operational voltage U_e (IEC 947-1; 4.3.1.1)

The voltage to which the characteristics of an equipment are referred. The rated operational current must not in any case exceed the rated insulation voltage.

Rated operational current I_e (IEC 947-1; 4.3.2.3)

The current which an equipment is capable of carrying taking into account the rated operational current, duration of operation, utilization category and ambient temperature.

Rated uninterrupted current I_u (IEC 947-1; 4.3.2.4)

The value of current which an equipment can carry in uninterrupted duty (i.e. for weeks, months or years).

Rated making capacity (IEC 947-1; 4.3.5.2)

The value of current which an equipment is capable of switching On in accordance with the utilization category and at the rated operational voltage.

Rated frequency (IEC 847-1; 4.3.3)

The frequency for which an equipment is designed and to which the other characteristic values are referred.

Rated ultimate short-circuit breaking capacity I_{cu} (IEC 947-2; 4.3.5.2.1)

The maximum prospective fault current which a circuit-breaker is capable of interrupting (test cycle: O - CO; previously P-1)

Rated insulation voltage U_i (IEC 947-1; 4.3.1 .2)

The voltage to which insulation tests and creepage distances of an equipment are referred. The maximum operational voltage must not in any case exceed the rated insulation voltage.

Rated short-circuit breaking capacity I_{cn} (IEC 947-1; 4.3.6.3)

The maximum value of current which an equipment is capable of switching Off at rated operational voltage and rated frequency, and without sustaining damage. It is expressed as r.m.s. value.

Motor rating (IEC 947-1; 4.3.2.3)

Power output of a motor at the associated operational voltage.

Rated control supply voltage U_s (IEC 947-1; 4.5.1)

The voltage applied to the input terminals of the control circuit of an equipment. Due to the presence of transformers or resistors in the control circuit, this may differ from the rated actuating (control circuit) voltage.

Rated impulse withstand voltage U_{imp} (IEC 947-1; 4.3.1 .3)

Measures the stability of the internal clearances of an equipment against overvoltage peaks. The utilization of suitable switchgear can ensure that overvoltages are prevented from transferring from the mains to deenergized system sections within it.

Rated current I_n (of a circuit-breaker) (IEC 947-2; 4.3.2.3)

For circuit-breakers, this current value is equal to the uninterrupted current and the conventional free air thermal current.

Protection against direct contact

Design measures incorporated into equipment in order to prevent direct contact, i.e. without tools, with live parts of a system (finger proof, back-of-hand proof).

Control circuit reliability

Measures the probability of switching states arising during the lifespan of a contact, which would be interpreted as faults by downstream electronic controllers (PLCs). Control circuit reliability is expressed in values based on tests using standard limit values for signal inputs.

Damp heat, constant

This test subjects the equipment to an ambient temperature of 40°C at a constant humidity of 93%. At set intervals during the test, the electrical and mechanical function of the equipment are examined.

Damp heat, cyclic

This test subjects the equipment to cyclically changing climatic conditions: a cycle applies 40°C ambient temperature at 93% relative humidity for 12 hours, followed by 12 hours of 25°C at 95% relative humidity. At set intervals during the test, the electrical and mechanical function of the equipment are examined.

Finger proof

An equipment whose live parts cannot be touched by the operator during actuation is termed finger proof. This also affects operator activity on neighbouring switching devices. The finger proof area of a push-actuated operating medium is a circular area of at least 30 mm radius around the actuating element, and vertical to the direction of actuation.

Within this circular area, touch-critical parts must be located at not less than 80 mm depth under the actuating level.

Utilization category (IEC 947-1; 2.1 .18/IEV 441-17-19)

A combination of specified requirements relating to the condition in which the switching device or the fuse fulfills its purpose, selected to represent a characteristic group of practical applications. The specified requirements may concern, e.g. the values of making capacities, breaking capacities and other characteristic values, data concerning associated circuits, and the relevant conditions of use and behaviour.

(IEC 947-2; 4.4)

For circuit-breakers, the utilization category denotes whether the equipment is designed for selectivity using time delay (category B) or not (category A).

Back-of-hand proof

An equipment whose live parts cannot be touched by a sphere of 50 mm diameter, is regarded as back-of-hand proof.

Altitude

The density of air decreases with increasing altitude, and this reduces its insulating capacity as well as its heat transfer capability. The rated operational voltage and current of switching devices, conductors and motors as well as the tripping behaviour of thermal overload relays are affected by this.

Upon request, OMRON ELECTRONICS will supply information as to the suitability or otherwise of switchgear for operation at altitudes above the 2000 m limit specified by the standard.

Conventional free air thermal current (IEC 947-1; 4.3.2.1)

The maximum value of current which an equipment is capable of carrying for a minimum of eight hours without thermal overloading. As a rule, it corresponds to the maximum operational current.

Creepage path (IEC 947-1; 2.5.51/IEV 151-03-37)

The shortest distance along the surface of the insulating material between two conductive parts. The creepage distance is determined by the rated insulation voltage, the pollution degree and the creepage current resistance of the material used.

Clearance (IEC 947-1; 2.5.46/IEV 441-17-31)

The distance between two conductive parts along a string stretched the shortest way between these conductive parts. The clearance in air is determined by the rated impulse withstand voltage, overvoltage category and pollution degree.

Emergency-stop switching device

Switching device within an emergency-stop circuit which is intended to prevent danger to persons, damage to machinery or working materials.

Opening delay (IEV 441-17-36)

The interval of time between the specified instant of initiation of the opening operation and the instant when the arcing contacts have separated in all poles. The opening time is the sum of the tripping time and the inherent delay of the contacts.

Closing delay

The interval of time between the instant of command and the first make operation of the contacts of the first pole to close. The closing delay is made up of the response delay and the closing time.

Shock resistance

The capacity of an equipment to withstand pulse-like motions without changing its operating status or sustaining damage. No contact lifting must take place on devices in the On position, the main contacts must not knock against each other in the Off position. A safety switch must not trip, and control circuit switches must not change their switching status.

Safe isolation (IEC 536, DIN VDE 0106 Part 101)

Isolation of circuits not carrying dangerous voltages (e.g. protective extra-low voltage) from circuits in which dangerous voltages flow. Such isolation is achieved by means of reinforced or double insulation which reliably prevents voltage transfer from one circuit to another. This might otherwise take place between main circuits and control circuits in switching devices or between transformer primary and secondary. "Safe isolation" is a priority requirement for safety circuits and functional low-voltage circuits.

Isolating function (IEC 947-1; 2.1.19)

Equipments are deemed to possess this isolating function provided their switching contacts when in the open position, achieve the separation distance prescribed for the isolation of electrical circuits, and their creepage paths and clearance distances are of the required size. The power supply to the entire installation or a section of the installation can thus be cut off for safety reasons, e.g. during maintenance.

Tamper proof

An emergency-stop switching device is regarded as tamper proof provided it cannot be reset without tools or via a prescribed procedure, after tripping has taken place. The device latches in the tripped position. Accidental or deliberate manipulation (inching) is thus ruled out.

Overvoltage category (IEC 947-1; 2.5.60)

Conventional number for prospective overvoltages at the point of installation, as might be caused for example by the effect of lightning or switching processes. The overvoltage category applicable to industrial switchgear is III. The applicability of switchgear according to the overvoltage categories is defined as follows:

Overvoltage category IV:

Use allowed directly at the termination point of the installation (directly affected by any lightning), e.g. at an overhead line connection point.

Overvoltage category III:

Operating media with special requirements as to the serviceability for connection in fixed installations, which are protected by overvoltage diversion measures, e.g. circuit-breakers in low-voltage distribution systems or in control systems for industrial use.

Overvoltage category II:

Power consumers for connection to fixed installations, e.g. household appliances, electrical tools.

Overvoltage category I:

Operating media for connection to circuits containing overvoltage protection schemes, e.g. electronic devices.

Ambient temperature, open (IEV 441-11-13)

Room temperature for example of the workshop or switch room in which the switching device is located.

Ambient temperature, enclosed (IEV 441-11-13)

Temperature at which the switching device is capable of being operated within a closed housing. For this purpose, it must be taken into account that the heat losses of the device will add to the internal temperature rise within the enclosure.

Losses (IEV 151-03-18)

The difference between the input power and the output power of a device. The main type of loss in electrical power distribution switchgear and operating media is current heat loss.

Pollution degree (IEC 947-1; 6.1.3.2)

Conventional number for the prospective quantities of conductive dust and humidity which can lead to a reduction in the control circuit reliability of a device. The pollution degree is described by the following influencing factors:

Pollution degree 1:

No pollution or only dry, non-conductive pollution occurs. The pollution does not affect the control circuit reliability.

Pollution degree 2:

Usually, only non-conductive pollution. However, transient conductivity through condensation is to be expected.

Pollution degree 3: (switchgear for industrial use)

Conductive pollution or dry, non-conductive pollution which is rendered conductive through condensation.

Pollution degree 4:

The pollution leads to long-term conductivity, e.g. pollution by conductive dust, rain or snow.

Coordination type

Status of a switchgear combination (motor starter) during and after testing at **rated conditional current**:

Coordination Type “1”:

- No risk to persons or installations
- No requirement for immediate readiness for renewed operation
- Damage to the starter is permissible

Coordination type “2”:

- No risk to persons or installations
- Starter is capable of renewed operation
- No damage to the starter with the exception of a slight welding of the contacts, provided they can be separated without significant deformation.

Positive opening operation

(IEC 947-1; 2.4.11/IEV 441-16-12)

This opening operation is designed to ensure that auxiliary contacts of a switching device are always in the respective positions corresponding to the open or closed position of the main contacts. The contacts of a contactor are **interlocked opposing contacts**, pro-

vided they are mechanically linked in such a way as to ensure that normally open and normally closed contacts can never be closed simultaneously.

This arrangement must also ensure that minimum contact separation of 0.5 mm is maintained over the entire lifespan of the device, even during a fault, e.g. the welding of one contact.

The relevant German Trade Association requires the use of contactors with interlocked opposing contacts for control systems on power presses in the metal processing industry.

Positive/enforced operation/actuation

This describes an arrangement where a link between the actuator and the switching element ensures that the force exerted on the actuator is transferred directly, i.e. without the intervention of sprung parts, onto the switching element.

Positive opening

(IEC 947-1; 2.4.10/IEV 441-16-11)

An opening operation which ensures that the main contacts of a mechanical switching device have attained the open position when the actuator is in the Off-position.

Symbols used in Technical Data and Formulae

DF	Duty factor	I_{th}	Conventional free air thermal current
I_{cn}	Rated short-circuit breaking capacity	I_{the}	Conventional thermal current of enclosed devices
I_{cs}	Rated service short-circuit breaking capacity	I_u	Rated uninterrupted current
I_{cu}	Rated ultimate short-circuit breaking capacity	S_{NT}	Transformer rating
I_e	Rated operational current	U_c	Rated actuating voltage
I''_{sc}	Transformer initial short-circuit current AC	U_e	Rated operational voltage
I_n	Rated current	U_i	Rated insulation voltage
I_{NT}	Rated transformer current	U_{imp}	Rated impulse withstand voltage
I_q	Rated conditional short-circuit current	u_k	Transformer short-circuit voltage
I_r	Set value of overcurrent release	U_s	Rated control voltage
I_{rm}	Response value of non-delayed short-circuit release		

● Additional ordering information for contactors

CE-Marking

The manufacturer has to sign his products with the CE-Marking. With the CE-Marking the manufacturer confirms the accordance with the different EEC Directives. The CE-Marking is absolutely necessary to sell the products in the EEC.

Attached you find the EEC Directives concerning our products.

Low Voltage Directive (73/23/EEC)

EMC Directive (89/336/EEC)

Declarations of Conformity art. no. D586.. on request.

Test Authorities, Registration Mark, Approvals















OMRON Low voltage switchgear is built and tested to national and international specifications. All devices suit all important specifications without any test obligation, like VDE, BS and also relative to IEC Recommendations and to European Standards like IEC 947 and EN 60947.



It is for this reason OMRON Low voltage switchgear is used all over the world. In order to provide special versions, limitations to the max. voltages, currents and power ratings or special markings are sometimes necessary.

OMRON Low voltage switchgear is also suitable for applications in marine environments.

They are classified in "Lloyd's Register of Shipping" and in the "Maritime Register of Shipping" (GUS). The "American Bureau of Shipping" does not claim a general approval for single components, the complete electrical equipment on board has to be approved. The devices should have UL- and CSA-approvals. Further information for Guide-No. and File-No. (CSA, UL) you will find on page 95.

For approved values see technical data of the devices.State deputy

Country	Canada	USA	Switzerland	Denmark	Norway	Sweden	Finland	Poland	Sllovakia	Czech	Hungaria
State deputy or private examination (state admitted)	CSA UL	UL	SEV	DEMKO	NEMKO	SEMKO	SETI	SEP	SKTC	EZU	MEEI
Label marking of examination boards		 									
Duty of approvals	All switchgear	 or  Approval of switchgear commendable	No approval since 1.1.1994 Our devices are according to the harmonised European Standards e.g. EN 60947 (IEC 947, VDE 0660) and can be used generally								
Specification	UL is authorised for approvals acc. to Canadian Standards		Marking with approbation label is no longer necessary								

*1) CSA-approvals are replaced by UL-approvals valid for USA and Canada. From 1. 1. 2000 switchgear will be marked with the combined approval. UL-mark  or  only.

Explanations for choice and supply of low voltage switchgears in Canada and USA

Marking of auxiliary contacts

At several devices in UL-data are two voltages for auxiliary contacts mentioned (e. g.: 600 volts at same potential, 150 volts at different potentials). That means, if the voltage is higher than 150 volts, the control voltage applied to input terminals must be at the same potential



Low voltage switchgear for auxiliary circuits (e. g. contactor relays, control units, auxiliary contacts in general) usually approved for "Heavy Duty" or "Standard Duty" UL and besides these marked with the admissible max. voltage or with short codes (see table).



Marking of auxiliary contacts according to CSA and UL	Max. rated values per pole				Contact Rating Code Designation
	Voltage	Current		Cont. Current	
		Make	Break		
Heavy Duty (HD or HVY DTY)	AC 120	60	6	10	A150
	AC 240	30	3	10	A300
	AC 480	15	1,5	10	A600
	AC 600	12	1,2	10	A600
	DC 125	2,2	2,2	10	N150
	DC 250	1,1	1,1	10	N300
	DC 600	0,4	0,4	10	N600
Standard Duty (SD or STD DTY)	AC 120	30	3	5	B150
	AC 240	15	1,5	5	B300
	AC 480	7,5	0,75	5	B600
	AC 600	6	0,6	5	B600
	DC 125	1,1	1,1	5	P150
	DC 250	0,55	0,55	5	P300
	DC 600	0,2	0,2	5	P600

Marking of auxiliary contacts according to CSA and UL	Max. rated values per pole				Contact Rating Code Designation
	Voltage	Current		Cont. Current	
		Make	Break		
-	AC 120	15	1,5	2,5	C150
	AC 240	7,5	0,75	2,5	C300
	AC 480	3,75	0,375	2,5	C600
	AC 600	3	0,3	2,5	C600
	DC 125	0,55	0,55	2,5	Q150
	DC 250	0,27	0,27	2,5	Q300
	DC 600	0,1	0,1	2,5	Q600
-	AC 120	3,6	0,6	1	D150
	AC 240	1,8	0,3	1	D300
	DC 125	0,22	0,22	1	R150
	DC 250	0,11	0,11	1	R300
-	AC 120	1,8	0,3	0,5	E150





LVSG

Discernment at UL-Standards

Recognized Component Industrial Control Equipment	Listed Industrial Control Equipment
UL issues yellow "Guide cards" with Guide- and File-No.	UL issues white "Guide cards" with Guide- and File-No.
Devices have permission to be marked with  on the label	Devices have to be marked with the "UL-Listing Mark"  .
Devices as components approved for "factory wiring": devices for employment in control panels, when they are selected, mounted and wired according to the charging conditions by skilled worker.	Devices approved for "field wiring", a) devices for employment in control panels, when they are mounted and wired by skilled worker. b) devices for retail in USA
Valid UL-Standards: UL 508„Standard for Industrial Control Equipment“ (partly limited)	Valid UL-Standards: UL 508„Standard for Industrial Control Equipment“ (unlimited) UL 486" Standard for Wire Connectors and Soldering Lugs"

Are devices approved as "Listed Equipment"  the approval is also valid for using as "Recognized Component" .

Approvals

Country	USA, Canada		Switzerland	Europe	Register of Shipping			CENELEC CB-Certificates
	UL 		SEV 		Great Britain LRS	GUS MRS	Italy RINA	
Type								
Mini Contactors J7KNA and Accessories								
J7KNA-AR...(D)	o	-	-	o	-	-	-	o
J7KNA-09...(D)	o	-	-	o	-	-	-	o
J7KNA-12...(D)	o	-	-	o	-	-	-	-
J73KN-A..., J73KN-AM	o	-	-	o	-	-	-	o
Contactors Series J7KN								
J7KN-10...(D)	o	-	-	o	-	-	-	o
J7KN-14...(D)	o	-	-	o	-	-	-	o
J7KN-18...(D)	o	-	-	o	-	-	-	o
J7KN-22...(D)	o	-	-	o	-	-	-	o
J7KN-24...(D)	o	-	-	o	-	-	-	o
J7KN-32...(D)	o	-	-	o	-	-	-	o
J7KN-40...(D)	o	-	-	o	-	-	-	o
J7KN-50...(D)	o	-	-	o	-	-	-	o
J7KN-62...(D)	o	-	-	o	-	-	-	o
J7KN-74...(D)	o	-	-	o	-	-	-	o
J7KN-85...(D)	o	-	-	o	-	-	-	o
J7KN-110...(D)	o	-	-	o	-	-	-	o
J7KN-150...	-	-	-	o	-	-	-	-
J7KN-175...	-	-	-	o	-	-	-	-
J7KN-200...	-	-	-	o	-	-	-	-
Accessories								
J73N-KB...	o	-	-	o	-	-	-	o
J73N-KC-115	o	-	-	o	-	-	-	x
J74KN-B-PT...	o	-	-	o	-	-	-	-
J74KN-A-VG...	o	-	-	o	-	-	-	-
J74KN-B-VG	-	-	-	o	-	-	-	-
Thermal Overload Relays								
J7TKN-B	o	-	-	o	-	-	-	x
J7TKN-C	o	-	-	o	-	-	-	x
J7TKN-D	o	-	-	o	-	-	-	x
J7TKN-A	o	-	-	o	-	-	-	o
J7TKN-E	o	-	-	o	-	-	-	o
J7TKN-F	-	-	-	o	-	-	-	-



o In Standard version approved

x In Test

- Not provided for test until now

 and -Guide- and File-No.

These data are important for UL-inspecting

Devices	Guide-No.			
				
	Kanada	USA	Kanada	USA
Contactors	NLDX7	NLDX	NLDX8	NLDX2
Accessories	NKCR7	NKCR	NKCR8	NKCR2
Thermal Overload Relays	NKCR7	NKCR	-	-
Circuit Breakers J7MN as Manual Motor Controller	NLRV7	NLRV	-	-
Circuit Breakers J7MN as Combination Motor Controller	NKJH7	NKJH	-	-
J7MN Bus Bar Assemblies	NLRV7	NLRV	-	-
J7MN Accessories	NKCR7	NKCR	-	-

■ Technical information

Degree of protection acc. to EN60947

Protection ratings are prefixed by the internationally agreed letters IP followed by two digits.

1st digit: Pertains to solid objects

2nd digit: Pertains to water.

1 st digit	Short description	Definition
1	Protected against solid objects greater than 50 mm	Excludes solid objects exceeding 50 mm in diameter and protects against contact with live and moving parts by a large body surface such as a hand (but not against deliberate access).
2L	Protected against solid objects greater than 12,5 mm and against contact by standard test finger	Excludes solid objects exceeding 12,5 mm in diameter and protects against contact with live and moving parts by a standard test finger or similar objects not exceeding 80 mm in length.
3	Protected against solid objects greater than 2,5 mm	Excludes solid objects exceeding 2,5 mm in diameter or thickness.
4	Protected against solid objects greater than 1 mm	Excludes solid objects exceeding 1 mm in diameter or thickness.
5	Dust protected	Prevents ingress of dust in quantities and locations that would interfere with the intended operation of the equipment.
6	Dust tight	Prevents ingress of dust.

Terminal markings acc. to EN50011

Auxiliary contacts of AC contactors and contacts of contactor relays and thermal overload relays are particularly marked. The terminal markings of normally-open contacts are printed as positive figures, they of normally-closed contacts as negative figures.

This gives a clear indication of the function of the contacts.

The figure below illustrates the determination of terminal markings for contactors with auxiliary contact blocks.

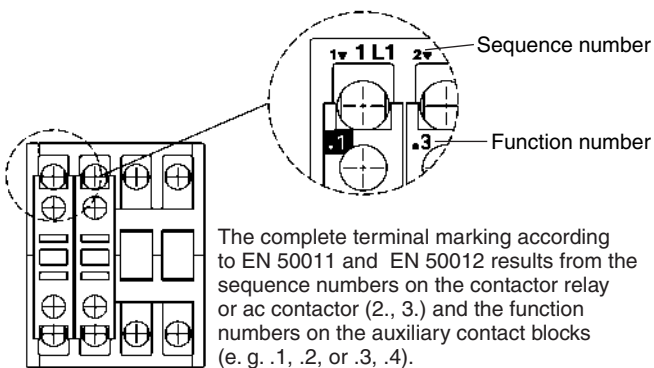

2 nd digit	Short description	Definition
1	Protected against-dripping water	Dripping water (vertically falling drops) shall have no harmful effect.
2	Protected against dripping water when tilted up to 15°	Vertically dripping water shall have no harmful effect when the enclosure is tilted at any angle up to 15° from its normal position.
3	Protected against spraying water	Water falling as a spray at an angle up to 60° from the vertical shall have no harmful effect.
4	Protected against splashing water	Water splashed against the enclosure from any direction shall have no harmful effect.
5	Protected against water jets	Water protected by a nozzle against the enclosure from any direction shall have no harmful effect.
6	Protected against heavy seas	Water from heavy seas or water projected in powerful jets shall not enter the enclosure in harmful quantities.
7	Protected against the effects of immersion	Ingress of water in a harmful quantity shall not be possible when the enclosure is immersed in water under standard conditions of pressure and time.
8	Protected against submersion	No ingress of water.

Resistance to climatic conditions acc. to IEC 68

Open-type devices are climate-resistant in the constant climate according to IEC 68-2-3 (this is a climate with an ambient temperature of 40°C and an atmospheric humidity of 90 to 95%).

Enclosed devices are climate-resistant in an alternating climate according to IEC 68-2-30 (this is a moist alternating climate with a 24-hour cycle between climates with an ambient temperature of 25°C, and an atmospheric humidity of 95 to 100% and an ambient temperature of 40°C, and an atmospheric humidity of 90 to 96% in the presence of condensation during rises in temperature).

Data are valid up to an altitude of 2000m above sea level.

Short circuit protection

Back up fuses should be used to protect contactors and starters against short circuits. For starters the device with the smaller admissible fuse at the main and at the control circuit (contactor or thermal overload) determines the fuse size.

After a short circuit devices have to be checked for correct operation.

Disconnect power before proceeding with any work on the equipment!

Mounting positions of contactors

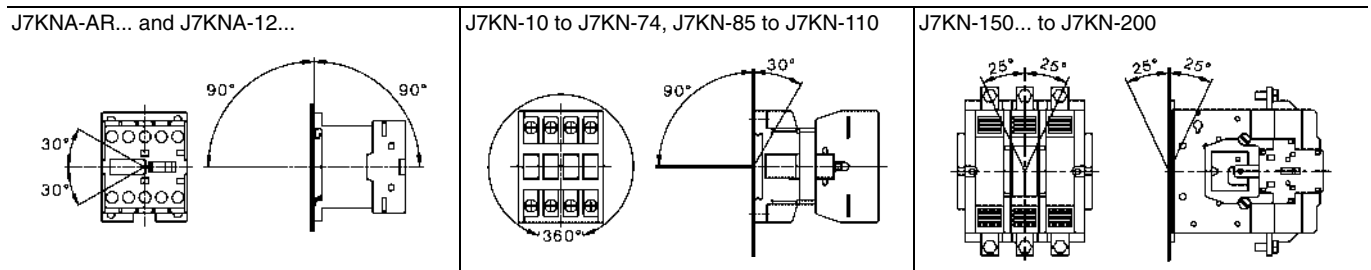

Terminal screws

Devices	Kind of connection	
	Screw with washer	Screw with clamp box
Mini Contactors		
All conductors		
J7KN-AR...; J7KNA-09...; J7KNA-12...	M3,5	-
Contactors		
Main conductor		
J7KN-10... to J7KN-22...	M3,5	-
J7KN-24... to J7KN-40...	-	M5
J7KN-50... to J7KN-74...	-	M6
J7KN-85..., J7KN-110...	-	M8
Auxiliary conductor		
J7KN-10... to J7KN-22...	M3,5	-
J7KN-85... to J7KN-110	M3,5	-

Devices	Kind of connection	
	Screw with washer	Screw with clamp box
Coil conductor		
J7KN-10... to J7KN-110...	M3,5	-
Accessories		
J73KNA(M)...	M3,5	-
J73KN-B, J73KN-C	M3,5	-
Thermal Overload Relays		
Main conductor		
J7TKN-A	M4	-
J7TKN-B	M3,5	-
J7TKN-C	M5	-
J7TKN-D	-	M6
Auxiliary conductor		
All devices	M3,5	-

Terminal screws in relation to screwdriver sizes and tightening torques

Terminal screws	Size	Pozidriv	Screw driver	Tightening torque	
				Nm	lb. inch
Screw with Pozidriv and slot	M3	Pz 1	Size 1	0,6 - 1,2	5 - 11
	M3,5	Pz 2	Size 2, 3	0,8 - 1,4	7 - 12
	M4	Pz 2	Size 3, 4	1,2 - 1,8	11 - 16
	M5	Pz 2	Size 3, 4, 5	2,5 - 3	22 - 26
	M6	Pz 3	Size 4, 5	3,5 - 4,5	31 - 40
Screw or nut with hexagonal-head	M8	-	-	6 - 10	53 - 88

● General technical information

■ Current carrying capacities of PVC insulated 600/1000 Volt cables with copper or aluminium conductors.

In accordance with the 16th edition of the "Wiring Regulations for Electrical Installations".

Basic assumptions: Ambient temperature of 30°C.

Circuit of protected by a OMRON circuit-breaker to IEC 947-2, or a fuse to BS 88 or BS 1361.

Figures must be adjusted by the correction factors for ambient temperature and/or cable grouping as detailed in the IEE regs.

Conductor size mm ²	In conduit or trunking (enclosed)				Clipped to surface or cable tray, bunched, embedded in plaster (unenclosed)				Fixed to vertical surface of wall or open cable trench with 20 mm separation between cables and wall			
	Single-phase		Three-phase		Single-phase		Three-phase		Single-phase		Three-phase	
	Cu [A]	Al [A]	Cu [A]	Al [A]	Cu [A]	Al [A]	Cu [A]	Al [A]	Cu [A]	Al [A]	Cu [A]	Al [A]
Single core, PVC insulated cable non-armoured, copper or aluminium conductors.												
1.0	13.5	-	12.0	-	15.5	-	14.0	-	-	-	-	-
1.5	17.5	-	15.5	-	20.0	-	18.0	-	-	-	-	-
2.5	24.0	-	21.0	-	27.0	-	25.0	-	-	-	-	-
4.0	32.0	-	28.0	-	37.0	-	33.0	-	-	-	-	-
6.0	41.0	-	36.0	-	47.0	-	43.0	-	-	-	-	-
10.0	57.0	-	50.0	-	65.0	-	59.0	-	-	-	-	-
16.0	76.0	-	68.0	-	87.0	-	79.0	-	-	-	-	-
25.0	101.0	-	89.0	-	114.0	-	104.0	-	126.0	-	112.0	-
35.0	125.0	-	110.0	-	141.0	-	129.0	-	156.0	-	141.0	-
50.0	151.0	118.0	134.0	104.0	182.0	134.0	167.0	123.0	191.0	144.0	172.0	132.0
70.0	192.0	150.0	171.0	133.0	234.0	172.0	214.0	156.0	246.0	185.0	223.0	169.0
95.0	232.0	181.0	207.0	161.0	284.0	210.0	261.0	194.0	300.0	225.0	273.0	206.0
120.0	296.0	210.0	239.0	186.0	330.0	245.0	303.0	226.0	349.0	261.0	318.0	240.0
150.0	300.0	234.0	262.0	204.0	381.0	283.0	349.0	261.0	404.0	301.0	369.0	277.0
185.0	341.0	266.0	296.0	230.0	436.0	324.0	400.0	299.0	463.0	344.0	424.0	317.0
240.0	400.0	312.0	346.0	269.0	515.0	384.0	472.0	354.0	549.0	407.0	504.0	375.0
300.0	458.0	358.0	394.0	306.0	594.0	444.0	545.0	410.0	635.0	469.0	584.0	435.0
400.0	546.0	-	467.0	-	694.0	-	634.0	-	732.0	-	679.0	-
500.0	626.0	-	533.0	-	792.0	-	723.0	-	835.0	-	778.0	-
630.0	720.0	-	611.0	-	904.0	-	826.0	-	953.0	-	892.0	-
Twin and multi-core PVC insulated cable, non-armoured, copper or aluminium conductors.												
1.0	11.0	-	11.5	-	15.0	-	13.5	-	17.0	-	14.5	-
1.5	14.0	-	15.0	-	19.5	-	17.5	-	22.0	-	18.5	-
2.5	18.5	-	20.0	-	27.0	-	24.0	-	30.0	-	25.0	-
4.0	25.0	-	27.0	-	36.0	-	32.0	-	40.0	-	34.0	-
6.0	32.0	-	34.0	-	46.0	-	41.0	-	51.0	-	43.0	-
10.0	43.0	-	46.0	-	63.0	-	57.0	-	70.0	-	60.0	-
16.0	57.0	54.0	62.0	48.0	85.0	66.0	76.0	59.0	94.0	73.0	80.0	61.0
25.0	75.0	71.0	80.0	62.0	112.0	83.0	96.0	73.0	119.0	89.0	101.0	78.0
35.0	92.0	86.0	99.0	77.0	138.0	103.0	119.0	90.0	148.0	111.0	126.0	96.0
50.0	110.0	104.0	118.0	92.0	168.0	125.0	144.0	110.0	180.0	135.0	153.0	117.0
70.0	139.0	131.0	149.0	116.0	213.0	160.0	184.0	140.0	232.0	173.0	196.0	150.0
95.0	167.0	157.0	179.0	139.0	258.0	195.0	261.0	170.0	282.0	210.0	238.0	183.0
120.0	192.0	-	206.0	160.0	299.0	245.0	259.0	197.0	328.0	-	276.0	212.0
150.0	219.0	-	225.0	184.0	344.0	283.0	299.0	227.0	379.0	-	319.0	245.0
185.0	248.0	-	255.0	210.0	392.0	324.0	341.0	259.0	434.0	-	364.0	280.0
240.0	291.0	-	297.0	248.0	461.0	384.0	403.0	305.0	514.0	-	430.0	330.0
300.0	334.0	-	339.0	258.0	530.0	444.0	464.0	351.0	593.0	-	497.0	381.0
400.0	-	-	402.0	-	634.0	-	557.0	-	715.0	-	597.0	-

Overall diameter of cables (Copper)

The dimensions are based on BS specification or the average values as given by the manufacturers.
The overall diameters given are for cables of 600/1000 V grade.

Number and nominal area of cables (mm ²)	Approx. overall diameter in mm		Number and nominal area of cables (mm ²)	Approx. overall diameter in mm	
	PVC/SWA	PVC		PVC/SWA	PVC
1 x 1.0	-	4.5	2 x 1.0	-	-
1 x 1.5	-	4.9	2 x 1.5	11.7	7.2
1 x 2.5	-	5.8	2 x 2.5	13.1	8.6
1 x 4.0	-	6.8	2 x 4.0	15.1	10.7
1 x 6.0	-	7.4	2 x 6.0	16.5	12.0
1 x 10.0	-	8.8	2 x 10.0	20.1	14.9
1 x 16.0	-	10.5	2 x 16.0	21.9	17.2
1 x 25.0	-	12.5	2 x 25.0	23.0	18.4
1 x 35.0	-	13.5	2 x 35.0	24.9	20.1
1 x 50.0	19.1	15.1	2 x 50.0	27.8	22.8
1 x 70.0	21.1	16.9	2 x 70.0	30.4	25.5
1 x 95.0	23.4	19.4	2 x 95.0	35.5	29.3
1 x 120.0	26.3	21.0	2 x 120.0	38.0	31.8
1 x 150.0	28.3	23.2	2 x 150.0	41.3	35.1
1 x 185.0	30.8	25.8	2 x 185.0	46.4	39.1
1 x 240.0	34.1	29.0	2 x 240.0	51.2	43.9
1 x 300.0	37.0	32.1	2 x 300.0	56.4	48.7
1 x 400.0	42.0	35.8	2 x 400.0	61.9	54.2
1 x 500.0	45.6	39.6	-	-	-
1 x 630.0	49.7	43.8	-	-	-

Number and nominal area of cables (mm ²)	Approx. overall diameter in mm		Number and nominal area of cables (mm ²)	Approx. overall diameter in mm	
	PVC/SWA	PVC		PVC/SWA	PVC
3 x 1.0	-	-	4 x 1.0	-	-
3 x 1.5	12.3	7.6	4 x 1.5	13.0	8.3
3 x 2.5	13.6	9.1	4 x 2.5	14.5	10.0
3 x 4.0	15.8	11.5	4 x 4.0	17.8	12.6
3 x 6.0	18.0	12.8	4 x 6.0	19.2	14.2
3 x 10.0	21.2	15.8	4 x 10.0	22.8	17.7
3 x 16.0	23.1	19.7	4 x 16.0	26.3	20.6
3 x 25.0	25.0	20.4	4 x 25.0	27.8	22.9
3 x 35.0	27.3	22.4	4 x 35.0	30.5	25.4
3 x 50.0	30.5	25.5	4 x 50.0	35.4	29.2
3 x 70.0	35.0	28.7	4 x 70.0	39.2	33.0
3 x 95.0	39.3	33.3	4 x 95.0	44.3	38.3
3 x 120.0	42.2	36.3	4 x 120.0	49.3	41.8
3 x 150.0	47.5	40.0	4 x 150.0	53.6	46.3
3 x 185.0	51.9	44.6	4 x 185.0	59.0	61.3
3 x 240.0	57.8	50.1	4 x 240.0	65.7	58.0
3 x 300.0	63.2	55.6	4 x 300.0	72.0	64.6
3 x 400.0	69.6	62.2	4 x 400.0	81.3	72.0

■ Conversion table

To convert	Multiply by
Inches to millimeters (mm)	25.4
Millimeters to inches (In.)	0.03937
Feet to meters (m)	0.3048
meters to feet (ft)	3.2808
Yards to meters (m)	0.9144
meters to yards (yd)	1.0936
Miles to kilometers (km)	1.6093
Kilometers to miles (mil.)	0.6214
Square inches to square millimeters (mm ²)	645.16
Square millimeters to square inches (inch ²)	0.00155
Square yards to square meters (m ²)	0.8361
Square meters to square yards (yd ²)	1.196
Cubic inches to cubic centimeters (cm ³)	16.387
Cubic centimeters to cubic inches (inch ³)	0.06102
Pounds to kilogrammes (kg)	0.4536
Kilogrammes to pounds (lb)	2.2046
Tons (2,240 lb) to kilogrammes (kg)	1,016.05
Kilogrammes to tons (240 lb)	0.0009842
Ounces (avoirdpois) to grammes (g)	28.3495
Grammes to ounces	0.0353
Gallons to litres (l)	4.561
Litres to gallons	0.220
Force N (newtons) to lbft 1 N = 1 kg (mass) accelerated at 1 metre/sec.	0.225
1 Nm = 1 J (joule) to calorie	0.239
Horse-power to kilowatts (kW)	0.7458
Kilowatts to horse-power (h.p.) 1 W (watt) = 1J/s	1.3408
Atmospheres to lb per square inch (lb/inch ²) 1 bar = 1 kg/cm ² = 735.6 mm Hg = 14.2 lb/inch ²	14.68

Conversion table for: Centigrade/Fahrenheit

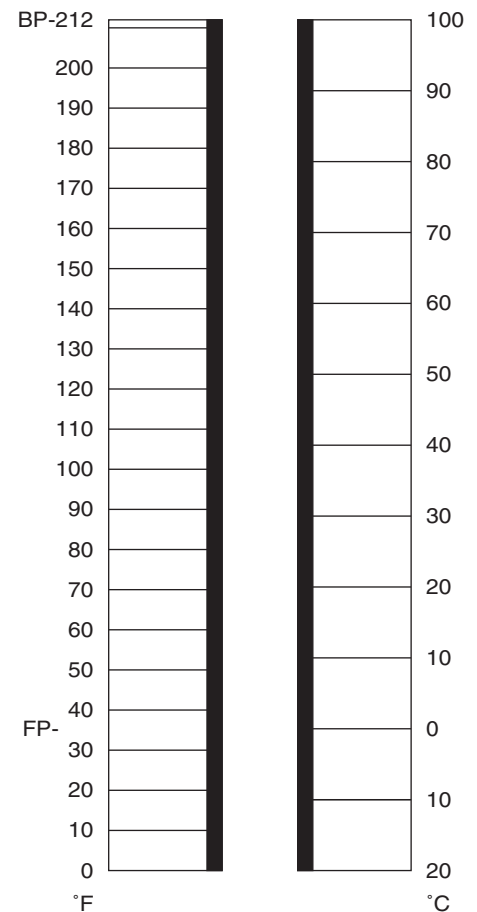

Conversion table for mm²/AWG cable sizes

mm ²	AWG
0.75	18
1.0	17
1.5	16
2.5	13
4.0	12
6.0	10
10.0	8

Rated currents of 3-phase motors (approx. figures for squirrel-cage motors)

Minimum fuse size for protection of 3-phase motors

The maximum size is determined by the requirements of the switchgear or overload relay.

The rated motor currents are for standard 1500 r.p.m. 3-phase enclosed ventilated and totally enclosed fan-cooled motors.

D.O.L. starting: Maximum starting current 6 x rated motor current. Maximum starting time 5 s.

Y/D starting: Maximum starting current 2 x rated motor current. Maximum starting time 15 s.

Set overload relay in the phase lead to 0.58 x rated motor current.

Rated fuse currents for Y/D starting are also valid for 3-phase motors with slip-ring motors.

For higher rated currents, starting currents and/or longer starting times, larger fuses are required.

Table is valid for "slow" and/or "gL" fuses (DIN VDE 0636).

For NH fuses with aM characteristics, fuses = rated current is selected.

Motor rating			230 V			400 V			415 V		
			Rated motor current	Fuse starting D.O.L.	Y/Δ	Rated motor current	Fuse starting D.O.L.	Y/Δ	Rated motor current	Fuse starting D.O.L.	Y/Δ
kW	cos φ	η %	A	A	A	A	A	A	A	A, BS	A, BS
0.06	0.7	58	0.37	2.0	-	0.21	2.0	-	0.21	2.0	2
0.09	0.7	60	0.54	2.0	-	0.31	2.0	-	0.30	2.0	2
0.12	0.7	60	0.72	4.0	2	0.41	2.0	-	0.40	2.0	2
0.18	0.7	62	1.04	4.0	2	0.6	2.0	-	0.58	2.0	2
0.25	0.7	62	1.4	4.0	2	0.8	4.0	2	0.8	4.0	2
0.37	0.72	66	2.0	6.0	4	1.1	4.0	2	1.1	4.0	2
0.55	0.75	69	2.7	10.0	4	1.5	4.0	2	1.5	6.0	4
0.75	0.79	74	3.2	10.0	4	1.9	6.0	4	1.8	6.0	4
1.1	0.81	74	4.6	10.0	6	2.6	6.0	4	2.6	10.0	6
1.5	0.81	74	6.3	16.0	10	3.6	6.0	4	3.5	16.0	10
2.2	0.81	78	8.7	20.0	10	5.0	10.0	6	4.8	16.0	10
3.0	0.82	80	11.5	25.0	16	6.6	16.0	10	6.4	20.0	16
4.0	0.82	83	14.8	32.0	16	8.5	20.0	10	8.2	20.0	16
5.5	0.82	86	19.6	32.0	25	11.3	25.0	16	10.9	25.0	20
7.5	0.82	87	26.4	50.0	32	15.2	32.0	16	14.6	35.0	25
11.0	0.84	87	38.0	80.0	40	21.7	40.0	25	20.9	50.0	32
15.0	0.84	88	51.0	100.0	63	29.3	63.0	32	28.2	80.0	40
18.5	0.84	88	63.0	125.0	80	36.0	63.0	40	35.0	80.0	50
22.0	0.84	92	71.0	125.0	80	41.0	80.0	50	40.0	80.0	50
30.0	0.85	92	96.0	200.0	100	55.0	100.0	63	53.0	100.0	80
37.0	0.86	92	117.0	200.0	125	68.0	125.0	80	65.0	125.0	80
45.0	0.86	93	141.0	250.0	160	81.0	160.0	100	78.0	125.0	80
55.0	0.86	93	173.0	250.0	200	99.0	200.0	125	96.0	160.0	100
75.0	0.86	94	233.0	315.0	250	134.0	200.0	160	129.0	250.0	160
90.0	0.86	94	279.0	400.0	315	161.0	250.0	200	155.0	250.0	160
110.0	0.86	94	342.0	500.0	400	196.0	315.0	200	189.0	315.0	200
132.0	0.87	95	401.0	630.0	500	231.0	400.0	250	222.0	355.0	250
160.0	0.87	95	486.0	630.0	630	279.0	400.0	315	269.0	355.0	315
200.0	0.87	95	607.0	800.0	630	349.0	500.0	400	337.0	450.0	355
250.0	0.87	95	-	-	-	437.0	630.0	500	421.0	500.0	450
315.0	0.87	96	-	-	-	544.0	800.0	630	525.0	630.0	560
400.0	0.88	96	-	-	-	683.0	1000.0	800	-	-	-
450.0	0.88	96	-	-	-	769.0	1000.0	800	-	-	-
500.0	0.88	97	-	-	-	-	-	-	-	-	-
560.0	0.88	97	-	-	-	-	-	-	-	-	-
630.0	0.88	97	-	-	-	-	-	-	-	-	-

LVSG

Minimum fuse size for protection of 3-phase motors

The maximum size is determined by the requirements of the switchgear or overload relay.

The rated motor currents are for standard 1500 r.p.m. 3-phase enclosed ventilated and totally enclosed fan-cooled motors.

D.O.L. starting: Maximum starting current 6 x rated motor current. Maximum starting time 5 s.

Y/D starting: Maximum starting current 2 x rated motor current. Maximum starting time 15 s.

Set overload relay in the phase lead to 0.58 x rated motor current.

Rated fuse currents for Y/D starting are also valid for 3-phase motors with slip-ring motors.

For higher rated currents, starting currents and/or longer starting times, larger fuses are required.

Table is valid for "slow" and/or "gL" fuses (DIN VDE 0636).

For NH fuses with aM characteristics, fuses = rated current is selected.

Motor rating			500 V			600 V		
			Rated motor current	Fuse starting D.O.L.	Y/Δ	Rated motor current	Fuse starting D.O.L.	Y/Δ
kW	cos φ	η %	A	A	A	A	A	A
0.06	0.7	58	0.17	2.0	-	0.12	2.0	-
0.09	0.7	60	0.25	2.0	-	0.18	2.0	-
0.12	0.7	60	0.33	2.0	-	0.24	2.0	-
0.18	0.7	62	0.48	2.0	-	0.35	2.0	-
0.25	0.7	62	0.70	2.0	-	0.50	2.0	-
0.37	0.72	66	0.90	2.0	2	0.70	2.0	-
0.55	0.75	69	1.20	4.0	2	0.90	4.0	2
0.75	0.79	74	1.50	4.0	2	1.10	4.0	2
1.1	0.81	74	2.1	6.0	4	1.5	4.0	2
1.5	0.81	74	2.9	6.0	4	2.1	6.0	4
2.2	0.81	78	4.0	10.0	4	2.9	10.0	4
3.0	0.82	80	5.3	16.0	6	3.8	10.0	4
4.0	0.82	83	6.8	16.0	10	4.9	16.0	6
5.5	0.82	86	9.0	20.0	16	6.5	16.0	10
7.5	0.82	87	12.1	25.0	16	8.8	20.0	10
11.0	0.84	87	17.4	32.0	20	12.6	25.0	16
15.0	0.84	88	23.4	50.0	25	17.0	32.0	20
18.5	0.84	88	28.9	50.0	32	20.9	32.0	25
22.0	0.84	92	33.0	63.0	32	23.8	50.0	25
30.0	0.85	92	44.0	80.0	50	32.0	63.0	32
37.0	0.86	92	54.0	100.0	63	39.0	80.0	50
45.0	0.86	93	65.0	125.0	80	47.0	80.0	63
55.0	0.86	93	79.0	160.0	80	58.0	100.0	63
75.0	0.86	94	107.0	200.0	125	78.0	160.0	100
90.0	0.86	94	129.0	200.0	160	93.0	160.0	100
110.0	0.86	94	157.0	250.0	160	114.0	200.0	125
132.0	0.87	95	184.0	250.0	200	134.0	250.0	160
160.0	0.87	95	224.0	315.0	250	162.0	250.0	200
200.0	0.87	95	279.0	400.0	315	202.0	315.0	250
250.0	0.87	95	349.0	500.0	400	253.0	400.0	315
315.0	0.87	96	436.0	630.0	500	316.0	500.0	400
400.0	0.88	96	547.0	800.0	630	396.0	630.0	400
450.0	0.88	96	615.0	800.0	630	446.0	630.0	630
500.0	0.88	97	-	-	-	491.0	630.0	630
560.0	0.88	97	-	-	-	550.0	800.0	630
630.0	0.88	97	-	-	-	618.0	800.0	630