

# ACTUATOR LA36

## Features:

- 12, 24 or 36 V DC Permanent magnetic motor
- Thrust from 500 N - 10.000 N depending on gear ratio and spindle pitch
- 10.000 N actuator cannot be ordered without electrical endstop
- 10.000 N actuator can be ordered in push and pull
- Max. speed up to 160 mm/sec. depending on load and spindle pitch
- Heavy duty aluminium housing for harsh conditions
- Highly efficient acme thread spindle
- Protection class: IP66 for outdoor use (dynamic), furthermore the actuator can be washed down by a high pressure cleaner (IP69K - static)
- Hand crank for manual operation
- Mechanical overload protection through integrated slip clutch (adjusted to 1.2-1.5 times max. load)
- Integrated brake, high self-lock ability
- End play – 2 mm max.
- Non rotating piston rod eye
- Back fixture turnable in steps of 30 degrees
- Noise level: 73 dB (A) measuring method DSI/EN ISO 8746 actuator not loaded

## Options:

- Built in end stop switches
- Adjustable magnetic sensors for end stop signals (code no. 1017031)
- Hall effect sensor with AIB –signal
- Potentiometer full scale at 333 mm stroke with 8 mm pitch, 500 mm stroke with 12 mm pitch and 833 mm with 20 mm pitch
- Analog feedback for precise positioning
- Different back fixtures and piston rod eyes
- Exchangeable cables in different lengths
- Resettable thermal overload protection

## Usage:

- Duty cycle at max. load 20% (up to 600 mm stroke, for strokes between 601-999 mm the max. duty cycle is 15%) at ambient temperature 25°C  
N.B. 10.000N 5% duty cycle.
- Ambient operating temperature -30°C to +65°C full performance from 5 - 40°C



**TECHLINE**  
IMPROVING FLEXIBILITY

LA36 is ideal for use in harsh conditions. It is a solid actuator based on the philosophy that it must be able to operate under extreme conditions. The actuator is ideal for mobile "off-highway" equipment such as agricultural, forestry and construction machines.



iFLEX is the new sub-brand under which every **TECHLINE**® actuator with built-in intelligence is unified e.g. LINBUS and MODBUS.

For more information on iFLEX, please see:  
[www.linak.com/techline](http://www.linak.com/techline)



WE IMPROVE YOUR LIFE

## Technical specifications LA36 with 12V motor

Order number	Push max. (N)	Pull max. (N)	*Self-lock min. (N) Push	*Self-lock min. (N) Pull	Pitch (mm/spindle rev.)	Typical speed (mm/s) Load		Standard stroke lengths (mm) In steps of 50 mm	Typical amp. (A) 12 V	
						no	full		No load	Full load
362CXXXXXXXXAXX	10000	10000	13000	13000	8	11	7	100 - 999*	4.5	22
363AXXXXXXXXAXX	2600	2600	3400	3400	12	40.7	30.6	100 - 999	4.5	21
363BXXXXXXXXAXX	4500	4500	5800	5800	12	23.1	17.8	100 - 999*	4.5	20.7
363CXXXXXXXXAXX	6800	6800	8800	8800	12	15.5	11.9	100 - 999*	4.5	21
365AXXXXXXXXAXX	1700	1700	2200	2200	20	68	52	100 - 999	4.5	22
365FXXXXXXXXAXX	500**	500**	1000	1000	20	160	135	100 - 999	4.5	20

## LA36 with 24V motor

Order number	Push max. (N)	Pull max. (N)	*Self-lock min. (N) Push	*Self-lock min. (N) Pull	Pitch (mm/spindle rev.)	Typical speed (mm/s) Load		Standard stroke lengths (mm) In steps of 50 mm	Typical amp. (A) 24 V	
						no	full		No load	Full load
362CXXXXXXXXBXX	10000	10000	13000	13000	8	11	7	100 - 999*	2.4	10.4
363AXXXXXXXXBXX	2600	2600	3400	3400	12	41	32.3	100 - 999	2.4	10.4
363BXXXXXXXXBXX	4500	4500	5800	5800	12	23.3	18.9	100 - 999*	2.4	10.2
363CXXXXXXXXBXX	6800	6800	8800	8800	12	15.7	12.7	100 - 999*	2.4	10.3
365AXXXXXXXXBXX	1700	1700	2200	2200	20	68	52	100 - 999	2.4	10.3
365FXXXXXXXXBXX	500**	500**	1000	1000	20	160	135	100 - 999	2.4	10.0

## LA36 with 36V motor

Order number	Push max. (N)	Pull max. (N)	*Self-lock min. (N) Push	*Self-lock min. (N) Pull	Pitch (mm/spindle rev.)	Typical speed (mm/s) Load		Standard stroke lengths (mm) In steps of 50 mm	Typical amp. (A) 36 V	
						no	full		No load	Full load
362CXXXXXXXXCXX	10000	10000	13000	13000	8	11	7	100 - 999*	2.0	8.0
363AXXXXXXXXCXX	2600	2600	3400	3400	12	41	33.5	100 - 999	2.0	8.0
363BXXXXXXXXCXX	4500	4500	5800	5800	12	23.3	19.1	100 - 999*	2.0	8.0
363CXXXXXXXXCXX	6800	6800	8800	8800	12	15.7	12.8	100 - 999*	2.0	8.0
365AXXXXXXXXCXX	1700	1700	2200	2200	20	68	52	100 - 999	2.0	8.0
365FXXXXXXXXCXX	500**	500**	1000	1000	20	160	135	100 - 999	2.0	8.0

\* There are limitations on the stroke length if you need full load, please see " LA36 Load v. Stroke Length"

\*\* Note: Fully loaded actuators need a softstart in order to prevent the clutch slipping at start (see curves).

## Speed and current curves:

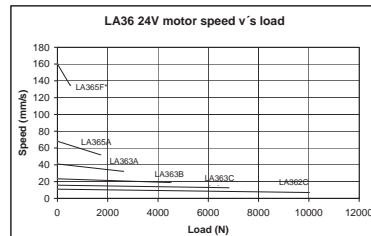
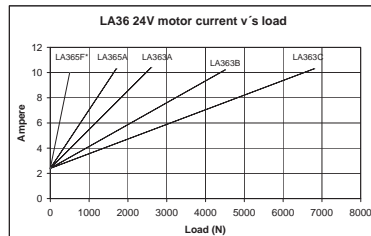
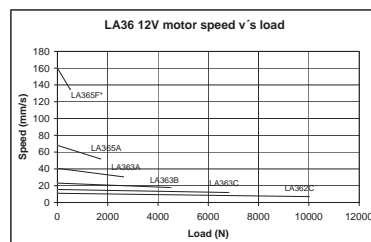
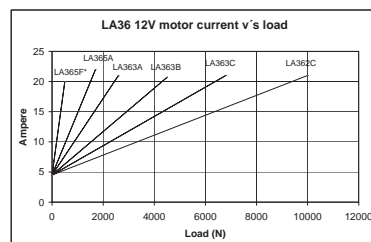

10.000N not tested

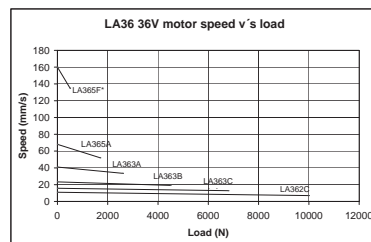
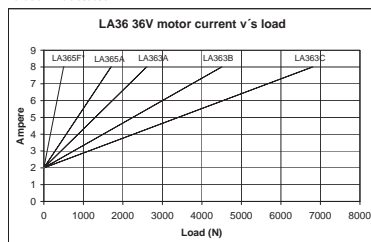

10.000N not tested

\* Speed and current based on nominal power supply of 12, 24, 36VDC.

# LA36

Ordering example:

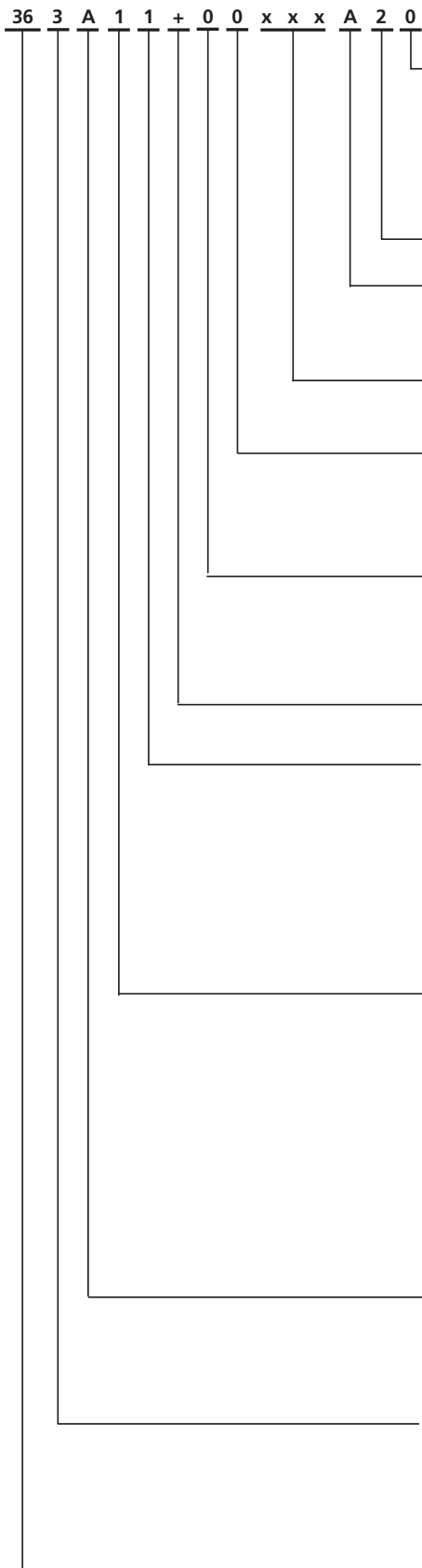

**Cable:**

- 0 = No cable
- 1 = 1.5 m power cable
- 2 = 5 m power cable
- 3 = 0.2 m power cable with AMP connector
- 4 = 1.5 m power and 1.5 signal
- 5 = 5 m power and 5 m signal
- 6 = 1.5 m Y-cable, power and signal in one

**IP-degree:**

- 2 = Standard (IP66)

**Motor type:**

- A = 12 V DC with clutch
- B = 24 V DC with clutch
- C = 36 V DC with clutch

**Stroke length:**

- XXX = mm Acme spindle:  
100, 150....999 mm

**Feedback:**

- 0 = Standard (No feedback)
- B = Analog feedback 0 - 10V
- C = Analog feedback 0.5 - 4.5V
- H = Hall signal
- P = Potentiometer (not possible with CS36)

**End stop:**

- 0 = No limit switches (not for spindle 2 and A)
- 1 = With limit switches
- 2 = With limit switches and end-stop signals
- 3 = CS36
- 4 = CS36 with end-stop signals

**Safety nut:**

- + = Without safety nut - Standard
- S = With safety nut - only in push

**Piston rod eye:**

- 0 = M20 X 1 female adapter
- 1 = ø 12.9 mm hole, for 1/2" pin
- 2 = ø 12.2 mm hole, for 12 mm pin
- 3 = M12 X 1.75 male adapter
- 4 = M16 X 1.5 male adapter
- 5 = ø 12.2 hole with slot (like LA34)
- A = 12.2 mm hole with slot - AISI 304
- B = 12.9 mm hole with slot - AISI 304
- C = Ball eye Ø12.2
- D = Ball eye Ø16

**Back fixture:**

- 0 = M20 X 1 female adapter
- 1 = ø 12.9 mm hole, for 1/2" pin
- 2 = ø 12.9 mm hole turned 90°, for 1/2" pin
- 3 = ø 12.2 mm hole, for 12 mm pin
- 4 = ø 12.2 mm hole turned 90°, for 12 mm pin
- 5 = M12 X 1.75 male adapter
- 6 = M16 X 1.50 male adapter
- 7 = ø 12.2 hole with slot (like LA34)
- 8 = ø 12.2 hole with slot (like LA34) turned 90°
- A = 12.2 mm hole with slot - AISI 304
- B = 12.2 mm hole with slot turned 90 degrees in AISI 304
- C = 12.9 mm hole with slot - AISI 304
- D = 12.9 mm hole with slot turned 90 degrees - AISI 304

**Gearbox:**

	<u>8 mm pitch</u>	<u>12 mm pitch</u>	<u>20 mm pitch</u>
A = Gear ratio 1 : 18	N.A.	2.600 N	1.700 N
B = Gear ratio 1 : 31	N.A.	4.500 N	N.A.
C = Gear ratio 1 : 46	10.000 N	6.800 N	N.A.
F = Gear ratio 1 : 7	N.A.	N.A.	500 N

**Spindle type:**

- 2 = 2-threaded acme spindle (8 mm pitch)
- 3 = 3-threaded acme spindle (12 mm pitch)
- 5 = 5-threaded acme spindle (20 mm pitch)
- A = 2 + adjustable reed limit switches (on outer tube)
- C = 3 + adjustable reed limit switches (on outer tube)
- E = 5 + adjustable reed limit switches (on outer tube)

**Actuator type:**

- 36 = LA36

NB: When ordering AISI piston rod eye and back fixture, stainless steel screws are automatically included.  
When ordering standard stroke length with end-stop 1, 2, 3, 4 or 5 the stroke length will be 3-4 mm shorter.

**LA36 dimensions:**

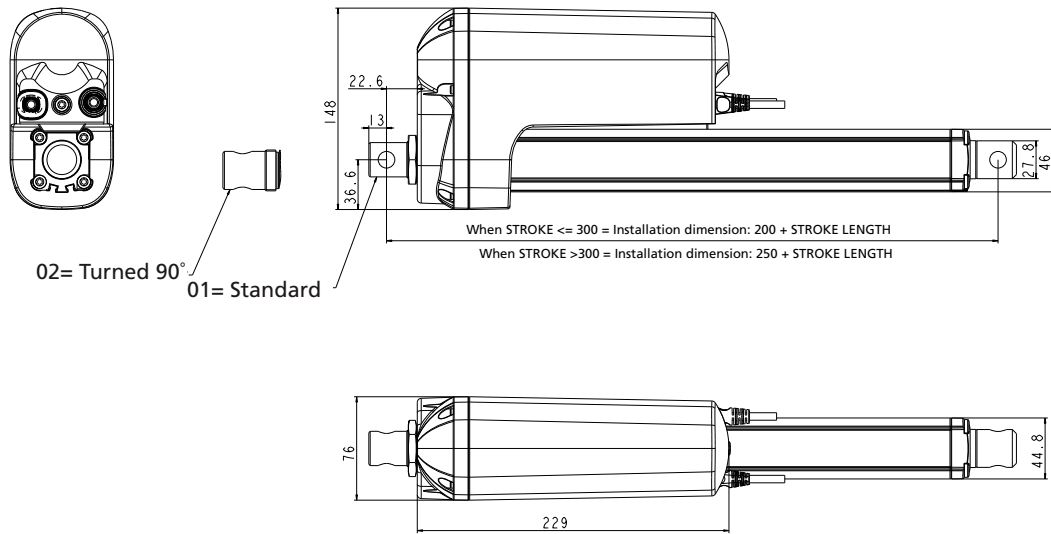

**I/O specifications: Power supply - Motor**

Item	Specification	Comment
<b>Power supply</b>		
Input voltage	12 VDC, ± 20% 24 VDC, ± 10% 36 VDC, ± 10%	Cable dimension: 2 x 2.5mm <sup>2</sup> (2 x AWG14) for all different voltages.
Duty cycle	20% at max. load	Ambient temperature 25°C
Current consumption	2 - 22 Amp. depending on load and voltage (see graphs)	
Connection	To extend actuator: Connect Brown to positive Connect Blue to negative  To retract actuator: Connect Brown to negative Connect Blue to positive	Actuator direction can be controlled with a double-throw switch with the middle position "off"

**Note:** Please note on variants with fast gear (500N-LA365F), it is necessary to use soft start to avoid the actuator clutch slipping when started.

**Positioning feedback – Potentiometer**

Item	Specification	Comment
Absolute positioning		
Potentiometer	Bourns 0 - 10 K ohm A 5%, 10-Turn	Type: 3540 Wirewound
Output range with 8 mm spindle pitch	0 K ohm = 0 mm stroke 10 K ohm = 333 mm stroke	The same for all LA36 8 mm models e.g. 166.6 mm stroke = 5 Kohm
Output range with 12 mm spindle pitch	0 K ohm = 0 mm stroke 10 K ohm = 500 mm stroke	The same for all LA36 12 mm models e.g. 250 mm stroke = 5 Kohm
Output range with 20 mm spindle pitch	0 K ohm = 0 mm stroke 10 K ohm = 833 mm stroke	The same for all LA36 20 mm models e.g. 416.5 mm stroke = 5 Kohm
Linearity	± 0.25%	
Output protection	1 Kohm protection resistor	
Connection	Common - = Black +10V excitation = White 0 = 10V out = Violet	+10V or other value

**Note:** Please note that Potentiometer is not possible on variants with fast gear (LA365F) -500N.

### Positioning feedback – Hall sensors.

Item	Specification	Comment
Relative positioning		
Signal description	Can be used for both direction and positioning	
Input Voltage	12 - 36 V DC	Cable dimension: 6 x 0.5 mm <sup>2</sup> (6 x AWG20) for all different voltages
Output voltage	Always the same as input voltage Note: max. output voltage 24V DC 12V : 11V ± 1V 24V : 23V ± 1V 36V : 23V ± 1V	
Resolution (Distance the piston rod moves per count)	LA362C: Actuator = 0.1 mm per count. LA363C: Actuator = 0.2 mm per count. LA363B: Actuator = 0.3 mm per count. LA363A: Actuator = 0.4 mm per count. LA365A: Actuator = 0.7 mm per count  <b>Movement per single Hall pulse:</b> LA362C Actuator = 0.4 mm per pulse LA363C Actuator = 0.7 mm per pulse LA363B Actuator = 1.0 mm per pulse LA363A Actuator = 1.7 mm per pulse LA365A Actuator = 2.9 mm per pulse	The Hall sensor signals are generated by the turning of the actuator gearing. These signals can be fed into a PLC (Programmable Logic Controller). In the PLC the quadrature signals (fig. 1) can be used to register the direction and position of the piston rod. N.B. For more precise measurements, please contact LINAK.
Frequency	Frequency is 14-26 Hz on A signal (and the same on B signal) depending on load. Every pulse is "ON" for 10 ms There is a phase shift of 90° ± 30° between the phases	Low frequency with a high load Higher frequency with no load
Current consumption	15 mA	Also when actuator is not running
Switching capacity	40 mA, max. pr. channel	Max. 680 nF
Connection	Supply = Red Hall A = Yellow Hall B = Green Common - = Black	
Diagram:	<p style="text-align: right;">Fig. 1</p>	

### I/O Specification: Analog feedback

Item	Specification	Comment
Description	The actuator can be equipped with electronic circuit that gives an analog feedback signal when the actuator moves	
Input voltage	12 - 36 V DC	Feedback circuit to be powered 1 second before motor runs, and until 1 second after the motor has stopped. Cable dimension 6 x 0,5 mm <sup>2</sup> (6 x AWG20)
Output voltage	0 -10 V 0V = Fully retracted 10V = Fully extended  0,5-4,5V (Option C) 0,5V = Fully retracted 4,5V = Fully extended	+/- 0.3 V
Current consumption	Max. 40 mA	Also when actuator is not running
Connection	Supply: White (Pin 3) (+12V to 36V) Ground: Black (Pin 1) Signal: Violet (Pin 4) (0 – 10V Out)	Use cable 0367003-XXXX
Combinations	The Absolute positioning shall be combined with limit switches. Can be combined with ends stop signal	36xxxxx1Bxxxxxx/36xxxxx1Cxxxxxx 36xxxxx2Bxxxxxx/36xxxxx2Cxxxxxx

**Note:** It is recommendable to have the actuator to activate its limit switches on a regular basis. End stop signal: max 20 mA available.

End stop signal: max 20 mA available

I/O Specification: PLC option.  
For more details contact LINAK.

LA36 Piston Rod Eye

Option "0"  
LINAK P/N: 0361016

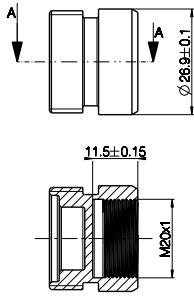

SECTION A-A

Option "1"  
LINAK P/N: 0361018

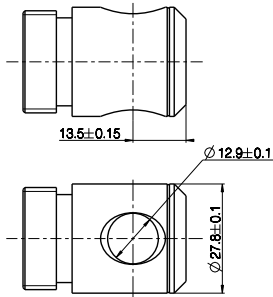

Option "4"  
LINAK P/N: 0361135

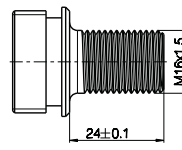

Option "5"  
LINAK P/N: 0361138

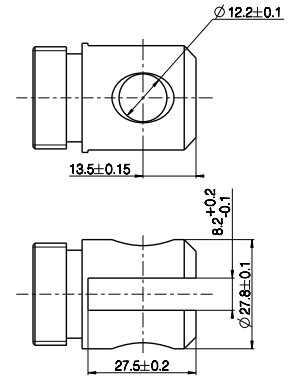

Option "2"  
LINAK P/N: 0361109

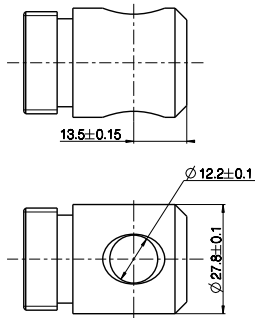

Option "3"  
LINAK P/N: 0361224

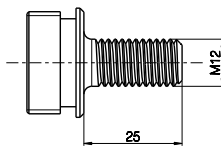

Option "C"  
LINAK P/N: 0361285

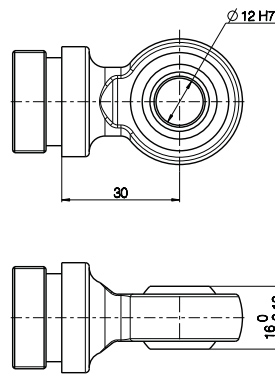

Option "D"  
LINAK P/N: 0361292

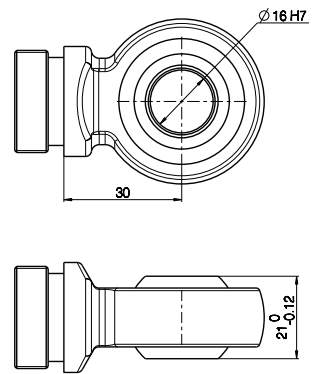

Option "A"  
LINAK P/N: 0361260

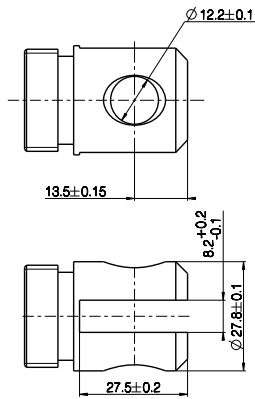

Option  
LINAK P/N:

Option "B"  
LINAK P/N: 0361275

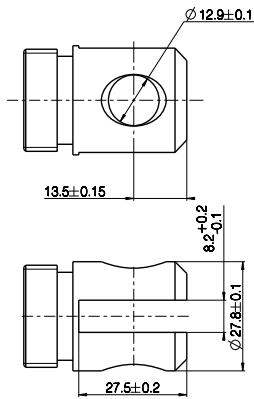

Option  
LINAK P/N:

## LA36 Back Fixture

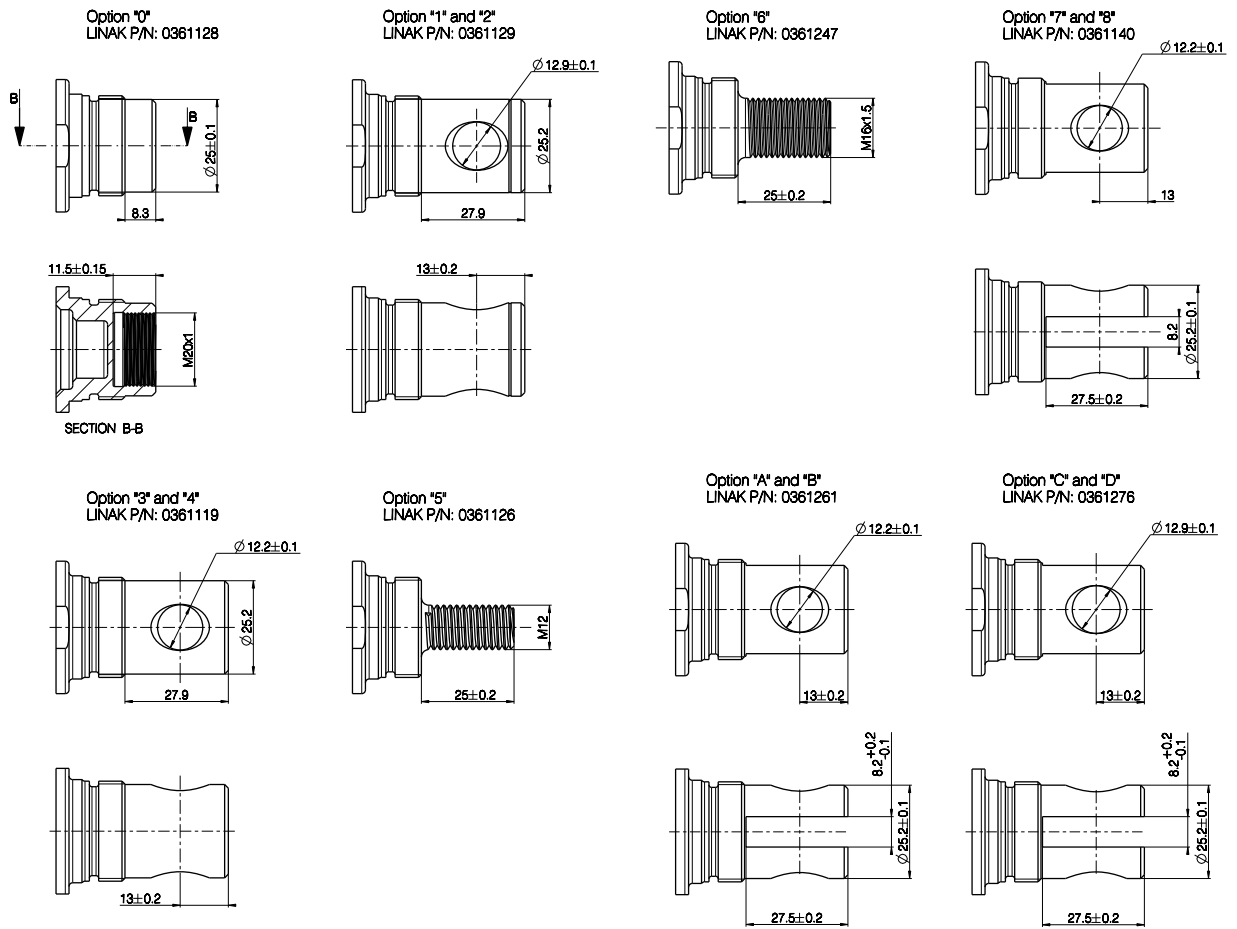

## LA36 Load versus Stroke Length

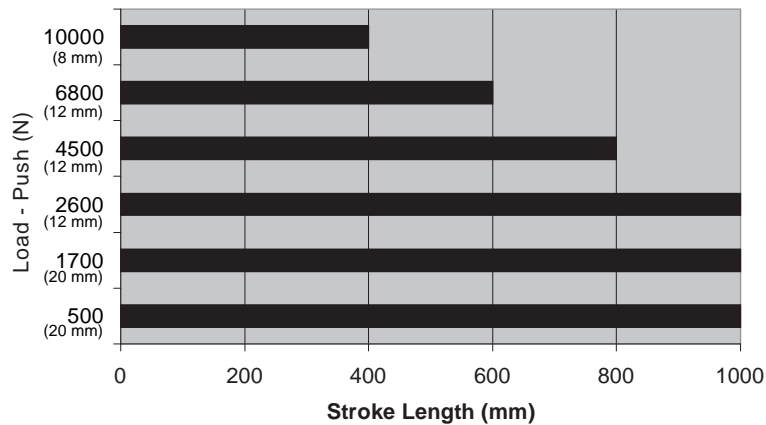

N.B.  
 LA36 500 - 1.700 N is with 20 mm spindle pitch  
 LA36 500 - 6.800 N is with 12 mm spindle pitch  
 LA36 500 - 10.000 N is with 8 mm spindle pitch



- For applications that only operate in pull the limitations are 999 mm stroke and 10,000 N load.
- The Piston Rod Eye is only allowed to turn 0-90 degrees
- Safety factor 2

## Manual hand crank

The manual hand crank can be used in the case of power failure.

The cover over the Allen Key socket must be unscrewed before the Allen Key can be inserted and the Hand Crank operated.

Hand Crank Torque: Max.16 Nm (at maximum load)

Piston Rod movement per turn

Gear A = 10.5 mm  
 Gear B = 6.0 mm  
 Gear C = 4.0 mm  
 Gear F = 27 mm



### Note:

- The power supply has to be disconnected during manual operation.
- If the actuator is operated as a Hand crank, it must be operated by hand or carefully by machine, otherwise there is a potential risk of overloading and hereby damaging the actuator. LA36 with CS or MODBUS options only operate by hand.
- With stainless steel screws: 5 mm Allen Key

## The LA36 is tested according to the following standards:

Test	Specification:	Comment
Cold test	EN60068-2-1 (Ab) EN60068-2-1 (Ad)	Storage at low temperature: -40°C Operating at low temperature: -30°C
Dry heat	EN60068-2-2 (Bb) EN60068-2-2 (Bd)	Storage at high temperature: +90°C Operating at high temperature: +60°C
Change of temperature	EN60068-2-14 (Na)	Rapid change in temperature: +100°C to -30°C
Damp heat	EN60068-2-30 (Db) EN60068-2-3 (Ca)	Damp heat, Cyclic: Relative humidity 93 - 98 % High +55°C, low +25°C Damp heat, Steady: Relative humidity 93 - 95 % +40°C ± 2°C
Salt spray	EN60068-2-52 (Kb)	Salt spray test: 500 hours incl. spraying periods + humidity storage
Degrees of protection	EN60529-IP66	IP6X – Dust: Dust-tight IPX6 – Water: No ingress of water causing damage
Chemicals	BS7691/96 hours	Resistant against: diesel, hydraulic oil, ethylene glycol, urea nitrogen, liquid lime, NPK fertilizers
Free fall		Free fall from all sides: 0.4 meters on to steel
Vibration	EN60068-2-36 (Fdb) EN60068-2-6 (Fc)	Random vibration: Short time 6.29 g RMS (Rod Mean Square) Long time 7.21 g RMS Sinus vibration: Freq. 5 - 25 Hz, amplitude = 3.3 mm pp Freq. 25 - 200 Hz, acceleration 4 g
Bump	EN60068-2-29 (Eb)	Bump test: Level 40 g for 6 milliseconds. 3,000 bumps
Shock	EN60068-2-27 (Ea)	Shock test: Level 100 g for 6 milliseconds
Power supply	ASAE EP455 (1990)	Operating voltages: +10 V - + 16V Over voltage +26(V) / 5 min
HF-immunity	EN61000-6-2	Level: 30V/m. at 26 MHz – 1000 MHz; 80% 1 KHz
Emission	EN61000-6-4	All levels are well within the norms of the emission standards
Insulation test		Level: 500 V AC/25-100 Hz for 1 minute
Automotive transients	ISO 7637	Load dump test only accepted on motor power connection

### Terms of use

The user is responsible for determining the suitability of LINAK products for specific application. LINAK takes great care in providing accurate and up-to-date information on its products. However, due to continuous development in order to improve its products, LINAK products are subject to frequent modifications and changes without prior notice. Therefore, LINAK cannot guarantee the correct and actual status of said information on its products. While LINAK uses its best efforts to fulfil orders, LINAK cannot, for the same reasons as mentioned above, guarantee the availability of any particular product. Therefore, LINAK reserves the right to discontinue the sale of any product displayed on its website or listed in its catalogues or other written material drawn up by LINAK. All sales are subject to the Standard Terms of Sale and Delivery for LINAK. For a copy hereof, please contact LINAK.