

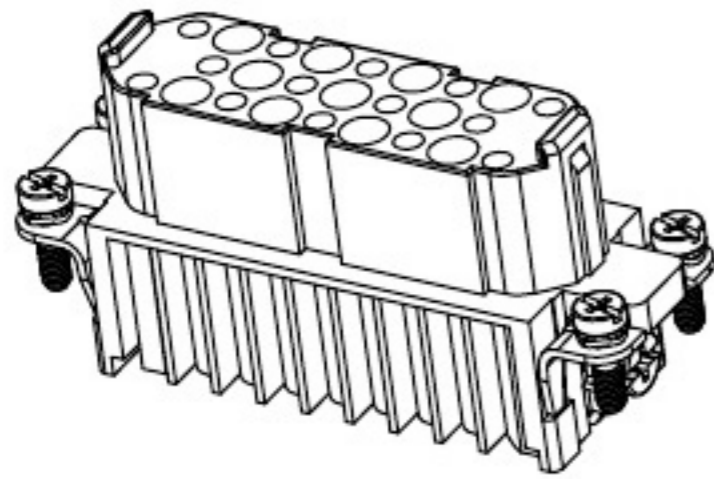

REVISION DATA				
SYM	ECN	DESCRIPTION	DATE	APPROVED

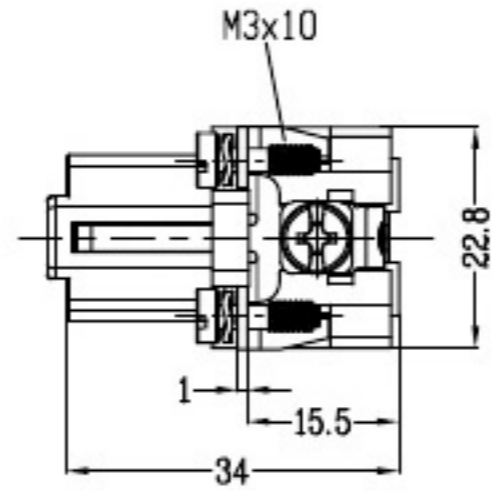
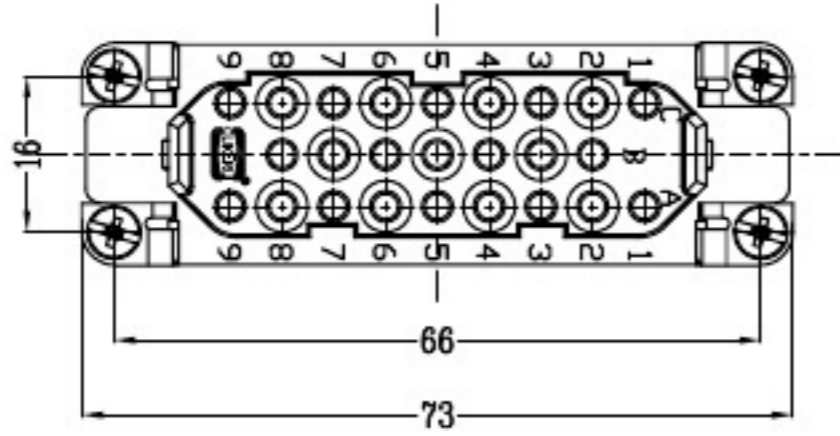
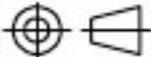

	SIGNATURE	DATE	Units	mm	 宁波欧科瑞连接器有限公司 NINGBO OKERUI CONNECTOR CO.,LTD.	
DRAW			Size	A4	PART NAME	HZW-HD-025-FC
DESIGN			Scale	1:1	Drawing NO.	61 204 025 432
CHECK			Sheet	1/1	REV	
APPROVE			Proj.		File path	OKR.HDP.025FC
						A0