

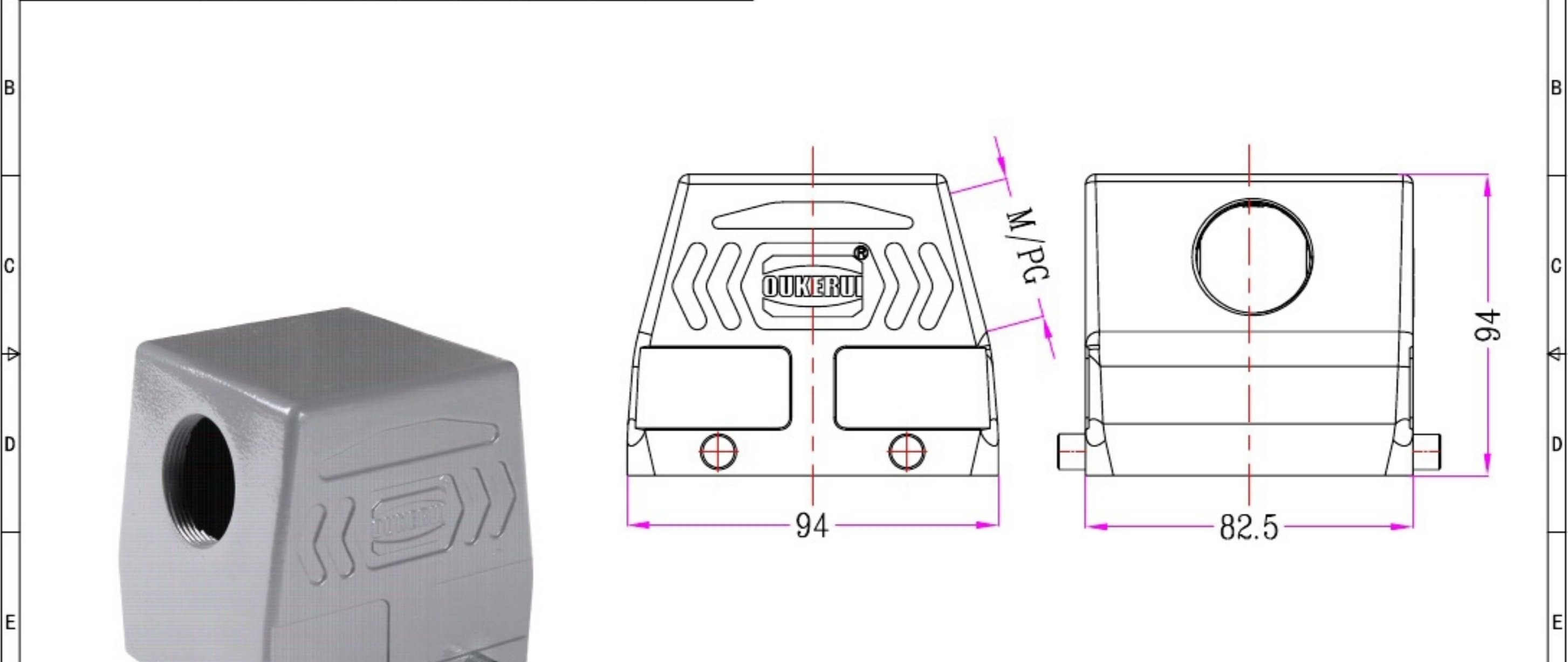

1	2	3	4	5	6	7	8		
Identification	Type name	Part number	Thread(M/PG)	Your Choice	REVISION DATA				
Hoods Side entry	HZW-H32B-SK-4g-M32	81 315 032 132	M32		SYM	ECN	DESCRIPTION	DATE	APPROVED
	HZW-H32B-SK-4g-M40	81 315 032 140	M40						
	HZW-H32B-SK-4g-M50	81 315 032 150	M50						
	HZW-H32B-SK-4g-PG29	81 315 032 129	PG29						
	HZW-H32B-SK-4g-PG36	81 315 032 136	PG36						
	HZW-H32B-SK-4g-PG42	81 315 032 142	PG42						



	SIGNATURE	DATE	Units	mm	 宁波欧科瑞连接器有限公司 NINGBO OKERUI CONNECTOR CO.,LTD.		
DRAW			Size	A4	TYPE NAME	HZW-H32B-SK-4g-M/PG	
DESIGN			Scale		Part number	81 315 032 XXX	REV
CHECK			Sheet	1/1	File path	OKR. 32B. H32BM	A0
APPROVE			Proj.	