

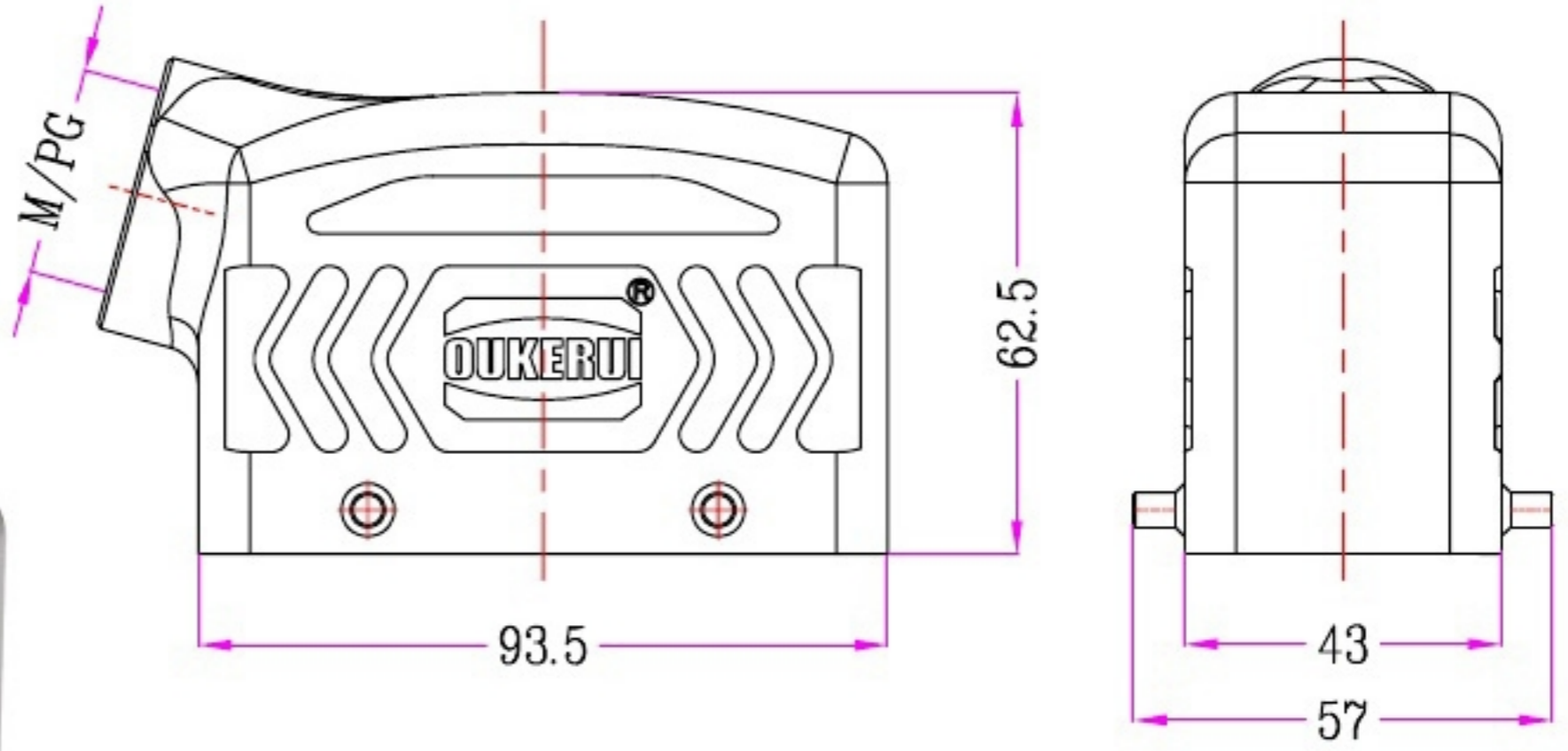

1	2		3	4	5	6		7	8	
Identification	Type name		Part number	Thread(M/PG)	Your Choice	REVISION DATA				
Hoods	HZW-H16B-SK-4g-M25		81 313 016 025	M25		SYM	ECN	DESCRIPTION	DATE	APPROVED
Side entry	HZW-H16B-SK-4g-M32		81 313 016 032	M32						
	HZW-H16B-SK-4g-PG21		81 313 016 021	PG21						



	SIGNATURE	DATE	Units	mm	 宁波欧科瑞连接器有限公司 NINGBO OKERUI CONNECTOR CO.,LTD.	
DRAW			Size	A4	TYPE NAME	HZW-H16B-SK-4g-M/PG
DESIGN			Scale		Part number	81 313 016 XXX REV
CHECK			Sheet	1/1	File path	OKR.16B.H16BM A0
APPROVE			Proj.	