

Compact compression load cell PR 6211 and mounting kits PR 6011/PR 6012

Compact design for a low system height

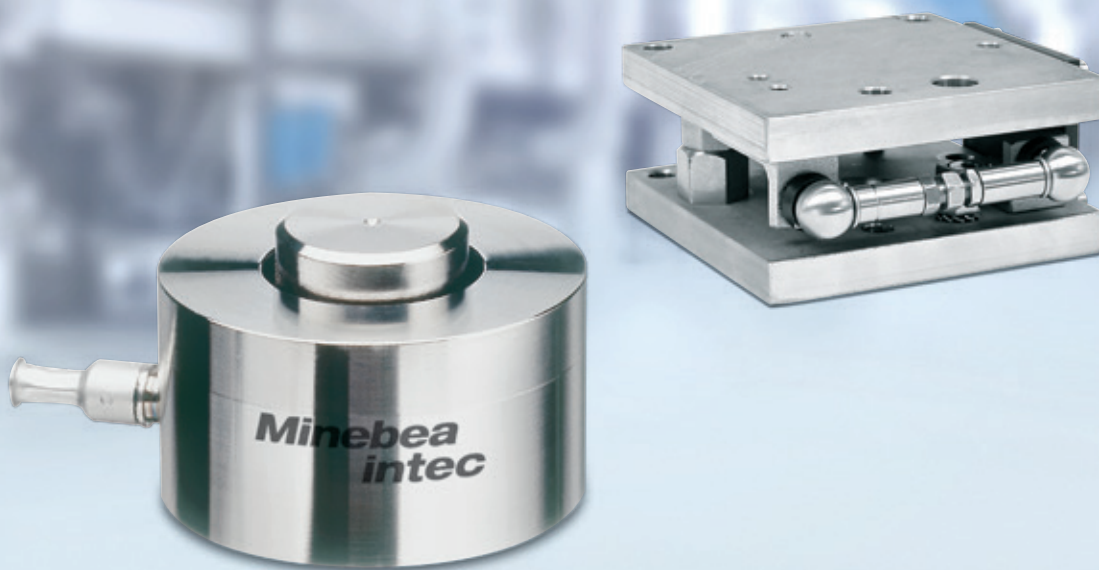

German Quality



The compact compression load cells of the PR 6211 series are specially designed for weighing vessels. Their design principle is based on a compact design which in combination with the space-saving mounting kits PR 6011 and PR 6012, enables them to be used in confined spaces.

The right solution for all of these uses:



Weighing



Filling and dosing



Fill quantity control

Technical specifications

Compact compression load cell PR 6211

Parameter	Description	Abbr.	D1 30 to 300 kg	Unit
Accuracy class			0.05	%E _{max}
Minimum dead load	Lowest limit of specified measuring range	E _{min}	0	%E _{max}
Maximum capacity	Highest limit of specified measuring range	E _{max}	See Ordering information table	kg
Safe load limit	Maximum load without irreversible damage	E _{lim}	500	kg
Destructive load	Danger of mechanical destruction	E _d	1,000	kg
Minimum LC verification	Minimum load cell verification interval, $v_{min} = E_{max}/Y$ – E _{max} = 50 to 300 kg – E _{max} = 30 kg	Y Y	3,333 2,500	
Rated output	Relative output at maximum capacity	C _n	2	mV/V
Tolerance on rated output	Permissible deviation from rated output	d _c	<0.25	%C _n
Zero output signal	Load cell output signal under unloaded condition	S _{min}	0 to 2	%C _n
Reproducibility	Max. change in load cell output for repeated loading	ε _R	<0.01	%C _n
Creep	Max. change of output signal under E _{max} during 30 min.	d _{cr}	<0.03	%C _n
Non-linearity	Max. deviation from best straight line through zero	d _{Lin}	<0.05	%C _n
Hysteresis	Max. difference in LC output between loading and unloading	d _{hy}	<0.05	%C _n
Temperature effect on S _{min}	Max. change of S _{min} in B _T	TKS _{min}	<0.042	%C _n /10 K
Temperature effect on C	Max. change of C in B _T	TK _c	<0.03	%C _n /10 K
Input impedance	Between supply terminals	R _{LC}	1,300 ± 12	Ω
Output impedance	Between measuring terminals	R _O	1,200 ± 2	Ω
Insulation impedance	Between measuring circuit and housing at 100 V _{DC}	R _{IS}	>5,000 × 10 ⁶	Ω
Recommended supply voltage	To hold the specified performance	B _u	4 to 24	V
Max. supply voltage	Permissible for continuous operation without damage	U _{max}	32	V
Nominal ambient temp. range	To hold the specified performance	B _T	-10 to +85	°C
Usable ambient temp. range	Permissible for continuous operation without damage	B _{TU}	-30 to +95	°C
Storage temperature range	Without electrical and mechanical stress	B _{TI}	-40 to +95	°C
Permissible eccentricity	Permissible displacement from nominal load line	S _{ex}	3	mm
Vibration resistance	Resistance against oscillations (IEC 68-2-6 Fc)		20 g, 100 h, 10 to 150Hz	
Barometric pressure influence	Influence of barometric pressure on output	PK _{Smin}	≤12	g/kPa
Nominal deflection	Max. elastic deformation under nominal load	S _{nom}	<0.1	mm
Material (sensor)	Stainless steel 1.4542			
Protection class	IP68			
Cable	Length: 3 m Diameter: 3 mm Cross section: 4 × 0.087 mm ² Material cable sheath: TPE			
Bending radius	≥ 15.5 mm at fixed installation ≥ 46.5 mm at flexible installation			

Mounting kits PR 6011 and PR 6012

Maximum capacity of load cell PR 6211	Mounting kit/ accessories	Material	Description/comments	Mounting screws	Installation height (mm)	Max. permissible horizontal force (kN)	Max. permissible lift-off force [kN]	Max. permissible eccentricity	Max. permissible vertical load without load cell
30 kg – 300 kg	PR 6011/00S	Stainless steel 1.4301 (AISI 304)	Plate mounting kit	M6	32.3	/	/	/	/
	PR 6011/20S		MiniFLEXLOCK	M6		0.45	/	/	/
	PR 6011/03	Natural rubber	Elastomeric bearing	/	37	/	/	/	/
	PR 6012/00S	Stainless steel 1.4301 (AISI 304)	Plate mounting kit	M6	42.2	/	4	/	300 kg
	PR 6012/20S		MiniFLEXLOCK	M6		0.45	4	/	300 kg

Technical diagrams

Load cell PR 6211 (30 kg to 300 kg)

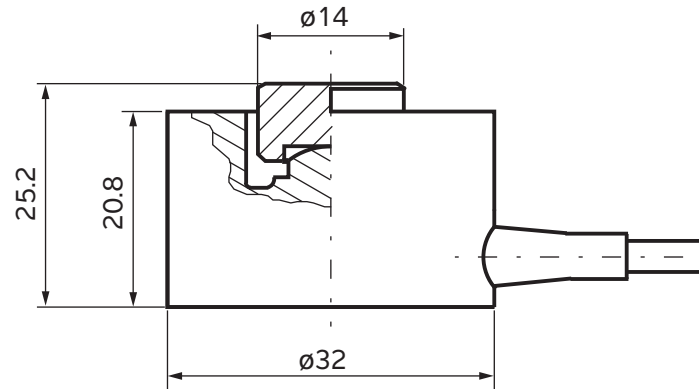
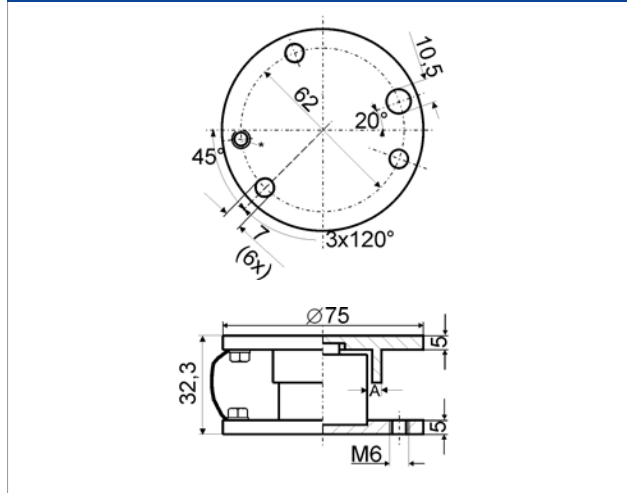
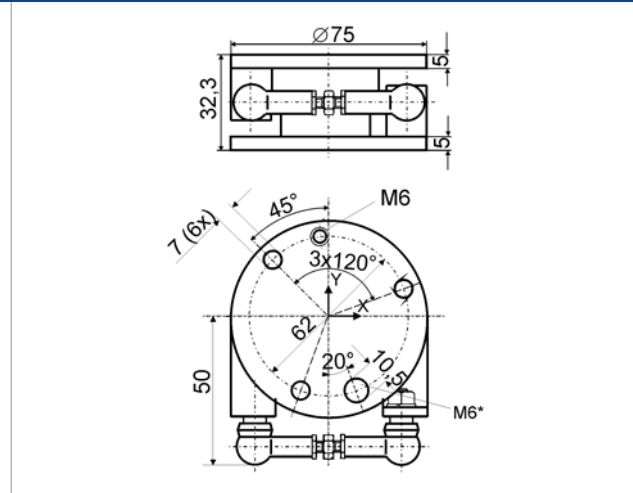

Plate mounting kit and MiniFLEXLOCK for PR 6211 (30 kg to 300 kg)



PR 6011/00S



PR 6011/20

Plate mounting kit and MiniFLEXLOCK for PR 6211 (30 kg to 300 kg)

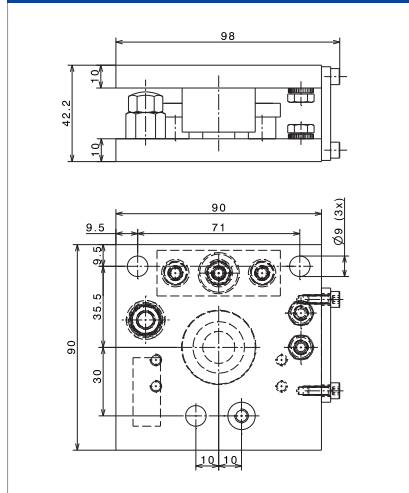

PR 6012/00S

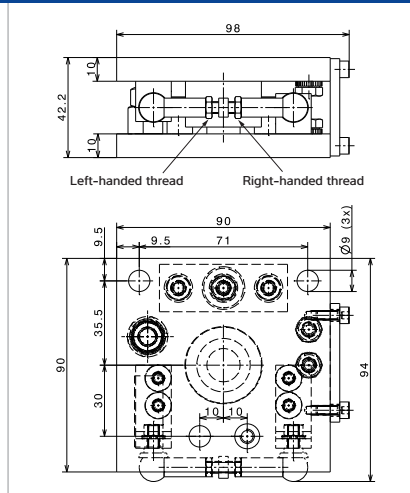

PR 6012/20S

Elastomeric bearing for PR 6211 (30 kg to 300 kg)

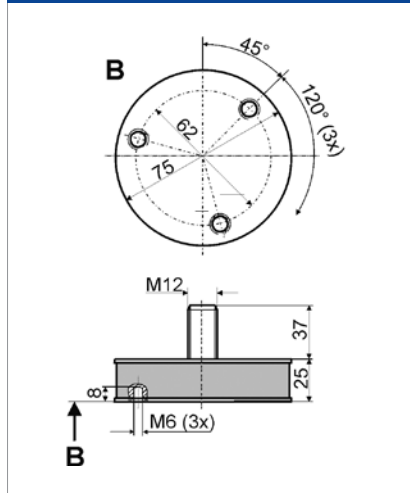

6011/03N

Ex approval

Scope of validity:

PR 6211/... D1 (30 kg to 300 kg)



Explosion protection

Ex certificates			
Zone	Labelling	Certificate number	For
2	II 3G Ex nA IIC T6 Gc	Manufacturer's declaration	all PR 6211
22	II 3D Ex tc IIIC T85 °C Dc	Manufacturer's declaration	all PR 6211
FMus class I, II, III div. 1 + 2	IS CL I, II, III, DIV 1, GP A,B,C,D,E,F,G Entity – 4012 101 5688 NI CL I, II, III, DIV 2, GP A,B,C,D,E,F,G – 4012 101 5688; NIFW T4A Ta= -30°C to 70°C; T5 Ta= -30°C to 55°C	FM17US0276	all PR 6211
FMca class I, II, III div. 1 + 2	IS CL I, II, III, DIV 1, GP A,B,C,D,E,F,G Entity – 4012 101 5688 NI CL I, II, III, DIV 2, GP A,B,C,D, E, F, G – 4012 101 5688; NIFW T4A Ta= -30°C to 70°C; T5 Ta= -30°C to 55°C	FM17CA0138	all PR 6211

Ordering information

The accuracy class of the compact compression load cell PR 6211 is classified and checked in accordance with OIML R60.



Compact compression load cell PR 6211, accuracy class D1=0.05%		
Type	Load stage	Order number
PR 6211/31D1	30 kg	940526211311
PR 6211/51D1	50 kg	940526211511
PR 6211/12D1	100 kg	940526211121
PR 6211/22D1	200 kg	940526211221
PR 6211/32D1	300 kg	940526211321

Mounting kits for PR 6211 (30 kg - 300 kg)		
Type	Description	Order number
PR 6011/00S	Mounting kit	940596011002
PR 6011/20S	Mounting kit with integrated constrainer	940596011202
PR 6012/00S	Mounting kit with additional functions	940536012002
PR 6012/20S	Mounting kit with additional functions and integrated constrainer	940536012202
PR 6011/03N	Elastomeric bearing	940536011031
PR 6011/09S	Mounting adapter for installation in mounting kit with large design	940536011092

The products and solutions presented in this data sheet make major contributions in the following sectors:



Food and beverages



Pharmaceutical



Chemical



Cosmetics



Machinery (OEM)

The technical data given serves as a product description only and should not be understood as guaranteed properties in the legal sense.

Specifications subject to change without notice.
Rev. 08/2018

Minebea Intec GmbH
Meiendorfer Straße 205 A
22145 Hamburg, Germany
Phone +49.40.67960.303
sales.hh@minebea-intec.com
www.minebea-intec.com