



**Part no.: 50131370**  
**CSL505-T05-235-M8**  
**Light curtain transmitter**



Figure can vary



## Contents

- Technical data
- Suitable receivers
- Dimensioned drawings
- Electrical connection
- Operation and display
- Part number code
- Accessories

Part no.: 50131370 – CSL505-T05-235-M8 – Light curtain transmitter

## Technical data

<b>Basic data</b>	
Series	505
Operating principle	Throughbeam principle
Device type	Transmitter
Application	Precise object detection
<b>Optical data</b>	
Operating range	Guaranteed operating range
Operating range	0.3 ... 5 m
Measurement field length	235 mm
Number of beams	48 Piece(s)
Beam spacing	5 mm
Light source	LED, Infrared
LED light wavelength	860 nm
<b>Measurement data</b>	
Minimum object diameter	7.5 mm
<b>Electrical data</b>	
Protective circuit	Polarity reversal protection Inductive protection Short circuit protected
<b>Performance data</b>	
Supply voltage	18 ... 30 V, DC
<b>Connection</b>	
Number of connections	1 Piece(s)
<b>Connection 1</b>	
Type of connection	Connector
Function	Deactivation input Voltage supply
Thread size	M8
Type	Male
Material	Metal
No. of pins	4 -pin
Encoding	A-coded
<b>Mechanical data</b>	
Design	Cubic
Dimension (W x H x L)	12 mm x 320 mm x 58 mm
Housing material	Metal, Aluminum
Lens cover material	Plastic
Housing color	Silver
Type of fastening	Through-hole mounting
<b>Operation and display</b>	
Type of display	LED
Number of LEDs	1 Piece(s)

## Part no.: 50131370 – CSL505-T05-235-M8 – Light curtain transmitter

Type of configuration	Software Via pin assignment
-----------------------	--------------------------------

### Environmental data

Ambient temperature, operation	-30 ... 50 °C
Ambient temperature, storage	-40 ... 65 °C

### Certifications

Degree of protection	IP 65
Protection class	III

### Classification

eCl@ss 8.0	27270910
eCl@ss 9.0	27270910
ETIM 5.0	EC002549

## Suitable receivers

	Part no.	Designation	Article	Description
	50131313	CSL505-R05-235-M8	Light curtain receiver	Operating range: 0.3 ... 5 m Digital switching outputs: 2 Piece(s) Switching output: Transistor, Push-pull, Light/dark reversible Connection: Connector, M8, 4 -pin

## Dimensioned drawings

All dimensions in millimeters

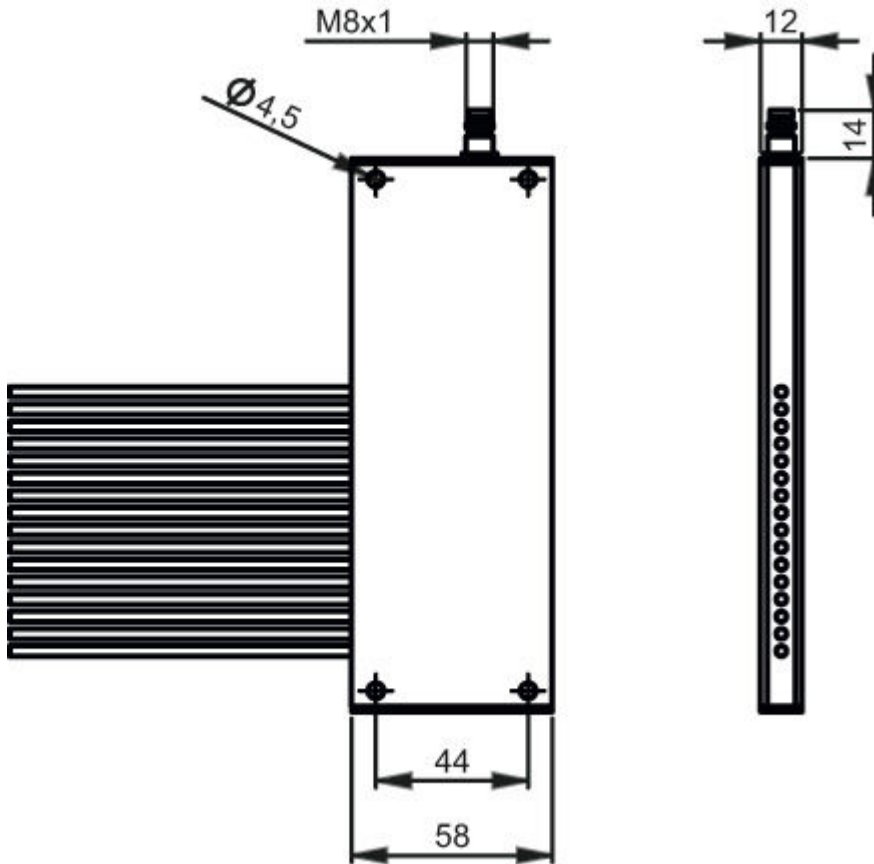

## Electrical connection

Connection 1	
Type of connection	Connector
Function	Deactivation input Voltage supply
Thread size	M8
Type	Male
Material	Metal
No. of pins	4 -pin
Encoding	A-coded

Pin	Pin assignment
1	V+
2	n.c.
3	GND
4	IN 1

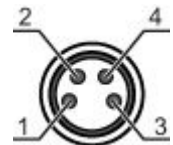

## Operation and display

### LEDs

LED	Display	Meaning
1	Off	Off
	Red, continuous light	Operational readiness
	Red, flashing	Error













## Part number code

Part designation:



▪

## Accessories











### Connection technology - Connection cables

	Part no.	Designation	Article	Description
 	50110274	K-D M8A-4P-10m-FAB	Connection cable	Connection 1: Connector, M8, Axial, Female, 4 -pin Connection 2: Open end Shielded: No Cable length: 10,000 mm Sheathing material: FAB
 	50106152	K-D M8A-4P-2m-FAB	Connection cable	Connection 1: Connector, M8, Axial, Female, 4 -pin Connection 2: Open end Shielded: No Cable length: 2,000 mm Sheathing material: FAB
 	50106153	K-D M8A-4P-5m-FAB	Connection cable	Connection 1: Connector, M8, Axial, Female, 4 -pin Connection 2: Open end Shielded: No Cable length: 5,000 mm Sheathing material: FAB
 	50110273	K-D M8W-4P-10m-FAB	Connection cable	Connection 1: Connector, M8, Angled, Female, 4 -pin Connection 2: Open end Shielded: No Cable length: 10,000 mm Sheathing material: FAB
 	50106154	K-D M8W-4P-2m-FAB	Connection cable	Connection 1: Connector, M8, Angled, Female, 4 -pin Connection 2: Open end Shielded: No Cable length: 2,000 mm Sheathing material: FAB
 	50106155	K-D M8W-4P-5m-FAB	Connection cable	Connection 1: Connector, M8, Angled, Female, 4 -pin Connection 2: Open end Shielded: No Cable length: 5,000 mm Sheathing material: FAB



**Part no.: 50131370 – CSL505-T05-235-M8 – Light curtain transmitter**

	Part no.	Designation	Article	Description
 	50130854	KD U-M8-4A-P1-020	Connection cable	Connection 1: Connector, M8, Axial, Female, 4 -pin Connection 2: Open end Shielded: No Cable length: 2,000 mm Sheathing material: PUR
 	50130855	KD U-M8-4A-P1-030	Connection cable	Connection 1: Connector, M8, Axial, Female, 4 -pin Connection 2: Open end Shielded: No Cable length: 3,000 mm Sheathing material: PUR
 	50130856	KD U-M8-4A-P1-050	Connection cable	Connection 1: Connector, M8, Axial, Female, 4 -pin Connection 2: Open end Shielded: No Cable length: 5,000 mm Sheathing material: PUR
 	50130857	KD U-M8-4A-P1-100	Connection cable	Connection 1: Connector, M8, Axial, Female, 4 -pin Connection 2: Open end Shielded: No Cable length: 10,000 mm Sheathing material: PUR
 	50130858	KD U-M8-4A-P1-150	Connection cable	Connection 1: Connector, M8, Axial, Female, 4 -pin Connection 2: Open end Shielded: No Cable length: 15,000 mm Sheathing material: PUR
 	50130859	KD U-M8-4A-P1-200	Connection cable	Connection 1: Connector, M8, Axial, Female, 4 -pin Connection 2: Open end Shielded: No Cable length: 20,000 mm Sheathing material: PUR
 	50130850	KD U-M8-4A-V1-050	Connection cable	Connection 1: Connector, M8, Axial, Female, 4 -pin Connection 2: Open end Shielded: No Cable length: 5,000 mm Sheathing material: PVC
 	50130851	KD U-M8-4A-V1-100	Connection cable	Connection 1: Connector, M8, Axial, Female, 4 -pin Connection 2: Open end Shielded: No Cable length: 10,000 mm Sheathing material: PVC
 	50130852	KD U-M8-4A-V1-150	Connection cable	Connection 1: Connector, M8, Axial, Female, 4 -pin Connection 2: Open end Shielded: No Cable length: 15,000 mm Sheathing material: PVC
 	50130853	KD U-M8-4A-V1-200	Connection cable	Connection 1: Connector, M8, Axial, Female, 4 -pin Connection 2: Open end Shielded: No Cable length: 20,000 mm Sheathing material: PVC

**Part no.: 50131370 – CSL505-T05-235-M8 – Light curtain transmitter**

	Part no.	Designation	Article	Description
	50130873	KD U-M8-4W-P1-020	Connection cable	Connection 1: Connector, M8, Angled, Female, 4 -pin Connection 2: Open end Shielded: No Cable length: 2,000 mm Sheathing material: PUR
	50130880	KD U-M8-4W-P1-020-DP	Connection cable	Connection 1: Connector, M8, Angled, Female, 4 -pin Connector, LED: Yes, 1 Piece(s) Connection 2: Open end Shielded: No Cable length: 2,000 mm Sheathing material: PUR
	50130874	KD U-M8-4W-P1-030	Connection cable	Connection 1: Connector, M8, Angled, Female, 4 -pin Connection 2: Open end Shielded: No Cable length: 3,000 mm Sheathing material: PUR
	50130875	KD U-M8-4W-P1-050	Connection cable	Connection 1: Connector, M8, Angled, Female, 4 -pin Connection 2: Open end Shielded: No Cable length: 5,000 mm Sheathing material: PUR
	50130881	KD U-M8-4W-P1-050-DP	Connection cable	Connection 1: Connector, M8, Angled, Female, 4 -pin Connector, LED: Yes, 1 Piece(s) Connection 2: Open end Shielded: No Cable length: 5,000 mm Sheathing material: PUR
	50130876	KD U-M8-4W-P1-100	Connection cable	Connection 1: Connector, M8, Angled, Female, 4 -pin Connection 2: Open end Shielded: No Cable length: 10,000 mm Sheathing material: PUR
	50130869	KD U-M8-4W-V1-020	Connection cable	Connection 1: Connector, M8, Angled, Female, 4 -pin Connection 2: Open end Shielded: No Cable length: 2,000 mm Sheathing material: PVC
	50130877	KD U-M8-4W-V1-020-DP	Connection cable	Connection 1: Connector, M8, Angled, Female, 4 -pin Connector, LED: Yes, 1 Piece(s) Connection 2: Open end Shielded: No Cable length: 2,000 mm Sheathing material: PVC
	50130870	KD U-M8-4W-V1-030	Connection cable	Connection 1: Connector, M8, Angled, Female, 4 -pin Connection 2: Open end Shielded: No Cable length: 3,000 mm Sheathing material: PVC
	50130871	KD U-M8-4W-V1-050	Connection cable	Connection 1: Connector, M8, Angled, Female, 4 -pin Connection 2: Open end Shielded: No Cable length: 5,000 mm Sheathing material: PVC

Part no.: 50131370 – CSL505-T05-235-M8 – Light curtain transmitter

	Part no.	Designation	Article	Description
	50130878	KD U-M8-4W-V1-050-DP	Connection cable	Connection 1: Connector, M8, Angled, Female, 4 -pin Connector, LED: Yes, 1 Piece(s) Connection 2: Open end Shielded: No Cable length: 5,000 mm Sheathing material: PVC
	50130872	KD U-M8-4W-V1-100	Connection cable	Connection 1: Connector, M8, Angled, Female, 4 -pin Connection 2: Open end Shielded: No Cable length: 10,000 mm Sheathing material: PVC

Connection technology - Interconnection cables

	Part no.	Designation	Article	Description
	50130916	KDS U-M8-4A-M8-4A-P1-020	Interconnection cable	Connection 1: Connector, M8, Axial, Female, 4 -pin Connection 2: Connector, M8, Axial, Male, 4 -pin Shielded: No Cable length: 2,000 mm Sheathing material: PUR

	Part no.	Designation	Article	Description
	50132069	CSL505-Interface	Module	Connection: Sub-D Functions: Configuration and test device