

JBC

www.jbctools.com

English



DDE-B Robot station

Ref. DDRE-B

Packing List

The following items should be included:

DDE Control Unit1 unit

Ref. DDE-1B (120V)
DDE-2B (230V)
DDE-9B (100V)



General purpose HD Handle with 3m cable1 unit

Ref. T470-SA



Converter1 unit

Ref. 0002747



Power cord1 unit

Ref. 0010569 (230V)
0013671 (100/120V)



Manual 1 unit

Ref. 0016281



Features



Working with Robots

Manage and monitor the station using a Robotic system.

1. Connect the tool to the station port by means of the Converter.
2. Connect your Robot system to the Robot connector (RJ12) of the station.
DB9-RJ12 Adapter available only if necessary (Ref: 0013772).
3. Enable the Robot option in the station settings and the notification will be displayed: 
4. Set your Robot's commands according to the Robot Communication Protocol, available on the website www.jbctools.com/jbcsoftware-menu-115.html.

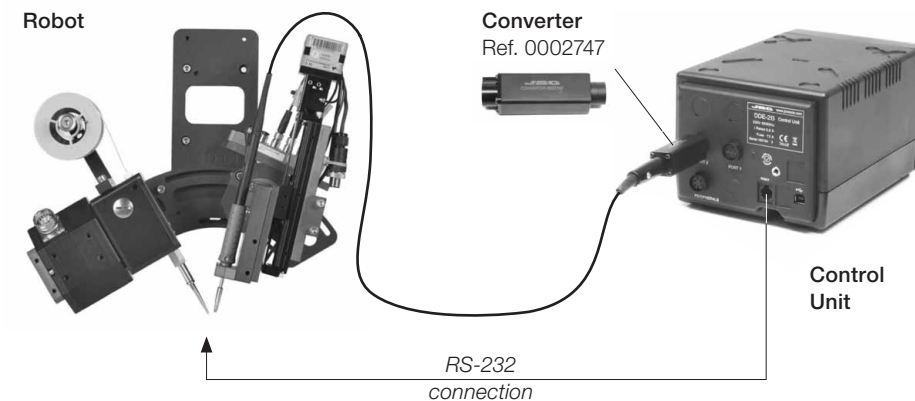

Compatible Soldering Iron Handles

JBC offers a wide range of handles and grips to choose from.

T470: Handles for Heavy Duty

Use C245 Cartridge range.

For intensive soldering jobs requiring continued high thermal power. They feature a non-slip-grip with a good thermal insulation and a screw which fixes the cartridge and prevents rotation.

HD Purpose Handle

Ref. T470-A



HD Purpose Handle with 3m cable

Ref. T470-SA

Tri-lobed HD Handle

Ref. T470-ZA



Thermal Insulator HD Handle

Ref. T470-FA

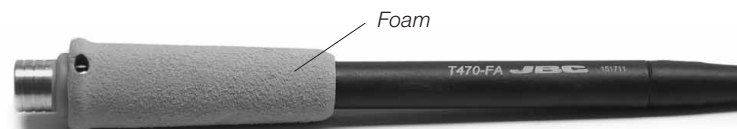

HD Thermal Insulator with 3m cable

Ref. T470-MA

Changing and fixing the Cartridges

Before changing the cartridge, be sure that the tip is cold.

Once the cartridge is properly inserted we recommend tightening the screw to prevent moving.

***Important:** It is essential to insert the cartridges as far as the mark for a good connection.

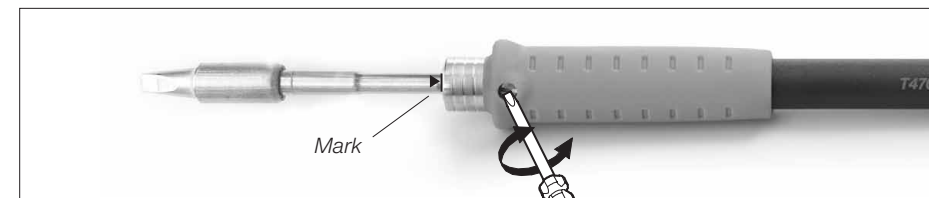

Compatible Cartridges

The DDRE-B works with C470 cartridges and T470 handles. Find the model that best suits your soldering needs in www.jbctools.com

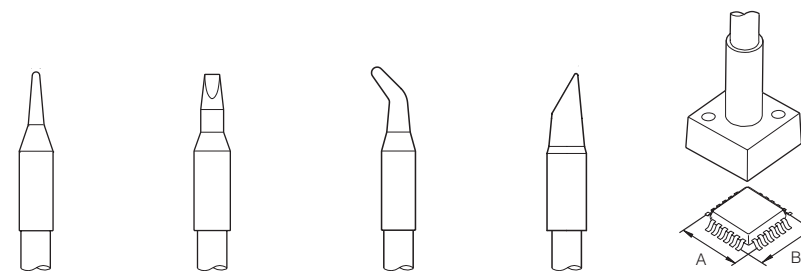

Round

Chisel

Round bent

Bevel

Special models

Note: All models are supplied with a 1.5m cable except those specified with 3m.

Work Screen

The DDE-B offers an **intuitive user interface** which provides **quick access** to the station parameters.

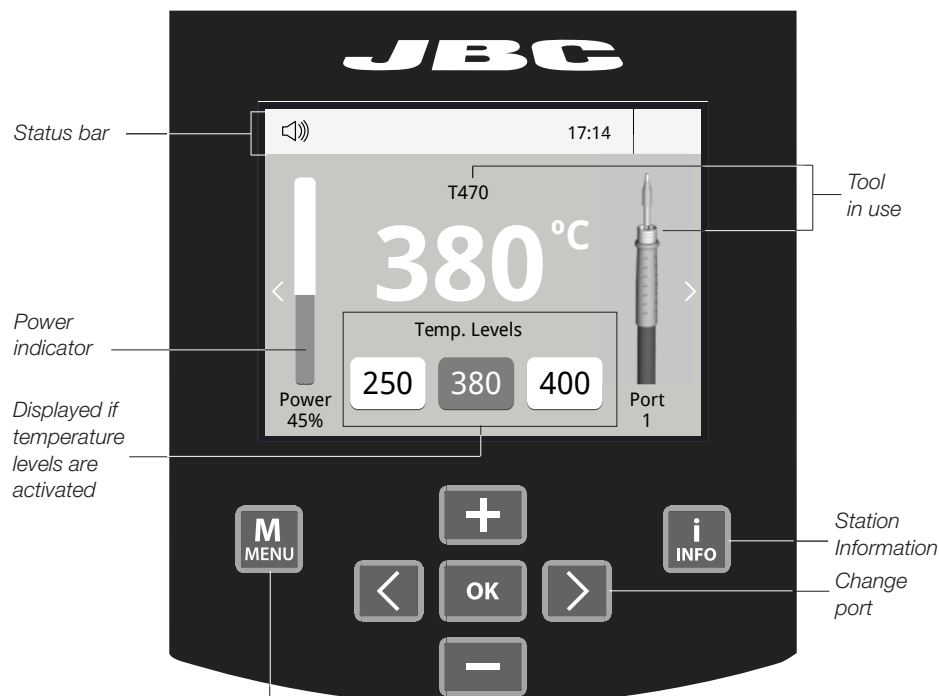

Menu Options

Press INFO for each parameter description.

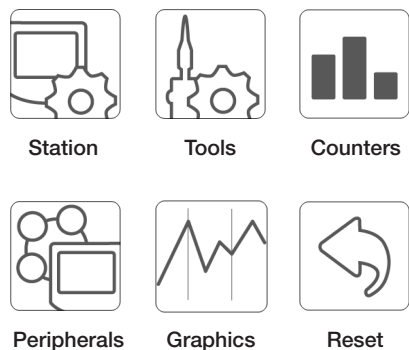

System notifications (Status Bar)

- USB flash drive is connected.
- Station is controlled by a PC.
- Station is controlled by a robot.
- Station software update. Press INFO to start the process.
- Warning. Press INFO for failure description.
- Error. Press INFO for failure description, the type of error and how to proceed.

Process analysis



Graphics

By pressing **Graphics** in the main MENU, temperature and power responses in real time are displayed for each port. This helps you decide which tip to use to obtain the best quality solder joints.

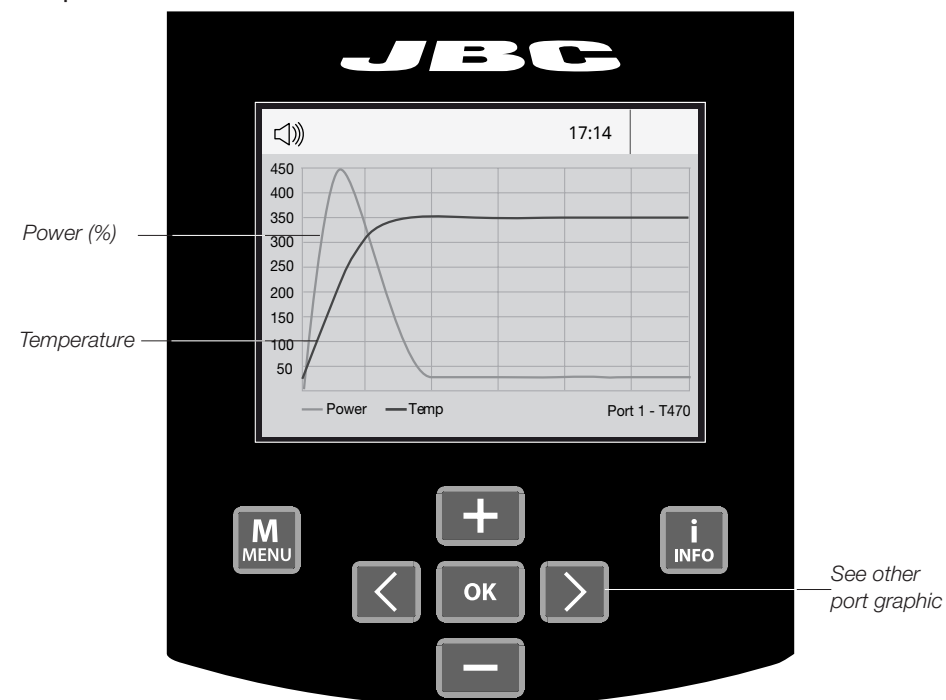

Export graphics

Insert a USB flash drive into the USB-A connector to start saving your soldering process in csv format.



Soldering Net

Remotely manage and monitor as many stations as your Windows PC can handle.

1. Download the **JBC Manager software** and the user manual from www.jbctools.com/manager.html
2. Connect the stations via USB-B connector and the PC will automatically detect them.
3. The notification  will be displayed on the station.

Functions:

- Set all the station parameters from your PC.
- Organize groups of stations and set all their parameters at the same time.
- Store specific configurations for later uses.
- Analyze the soldering graphics of the stations on your PC and export them.

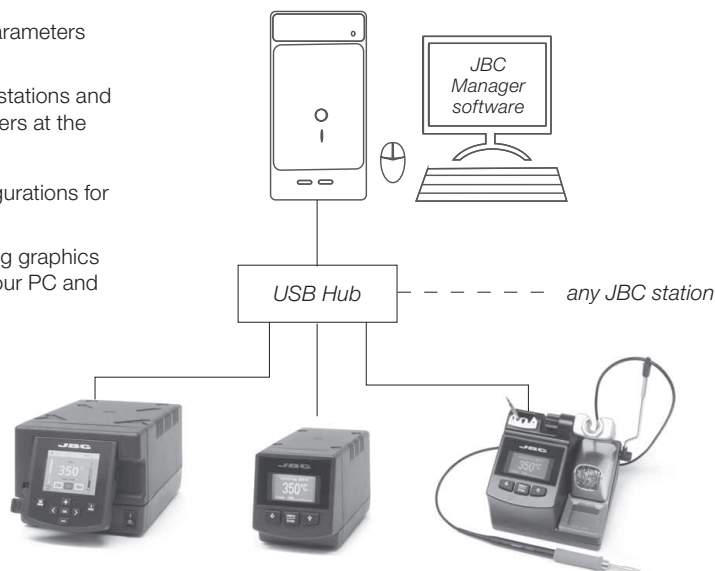

Update the station software

1. Download the JBC Update file from www.jbctools.com/software.html and save it on a USB flash drive. Preferably one with no other files.



2. Insert the USB flash drive. The icon  is displayed while updating.



Maintenance

Before carrying out maintenance or storage, always allow the equipment to cool.

- Clean the station screen with a glass cleaner or a damp cloth.
- Use a damp cloth to clean the casing and the tool. Alcohol can only be used to clean the metal parts.
- Periodically check that the metal parts of the tool and stand are clean so that the station can detect the tool status.
- Maintain tip surface clean and tinned prior to storage in order to avoid tip oxidation. Rusty and dirty surfaces reduce heat transfer to the solder joint.
- Periodically check all cables and tubes.
- Replace a blown fuse as follows:

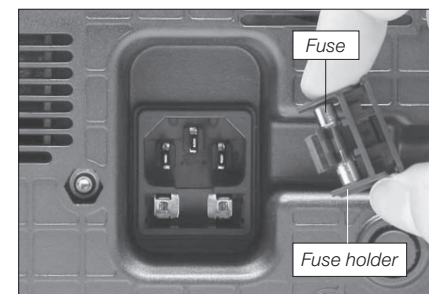
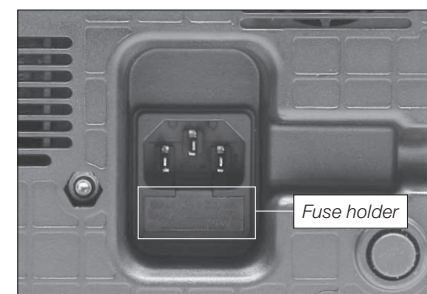

1. Pull off the fuse holder and remove the fuse. If necessary use a tool to lever it off.

2. Press the new fuse into the fuse holder and replace it in the station.

- Replace any defective or damaged pieces. Use original JBC spare parts only.
- Repairs should only be performed by a JBC authorized technical service.

Safety



It is imperative to follow safety guidelines to prevent electric shock, injury, fire or explosion.

- Do not use the units for any purpose other than soldering or rework. Incorrect use may cause fire.
- The power cord must be plugged into approved bases. Be sure that it is properly grounded before use. When unplugging it, hold the plug, not the wire.
- Do not work on electrically live parts.
- The soldering tip and the metal part of the tool may still be hot even when the station is turned off. Handle with care.
- Do not leave the appliance unattended when it is on.
- Do not cover the ventilation grills. Heat can cause inflammable products to ignite.
- Use a "non residue" classified flux and avoid contact with skin or eyes to prevent irritation.
- Be careful with the fumes produced when soldering.
- Keep your workplace clean and tidy. Wear appropriate protective glasses and gloves when working to avoid personal harm.
- Utmost care must be taken with liquid tin waste which can cause burns.
- This appliance can be used by children over the age of eight and also persons with reduced physical, sensory or mental capabilities or lack of experience provided that they have been given adequate supervision or instruction concerning use of the appliance and understand the hazards involved. Children must not play with the appliance.
- Maintenance must not be carried out by children unless supervised.

Exploded View

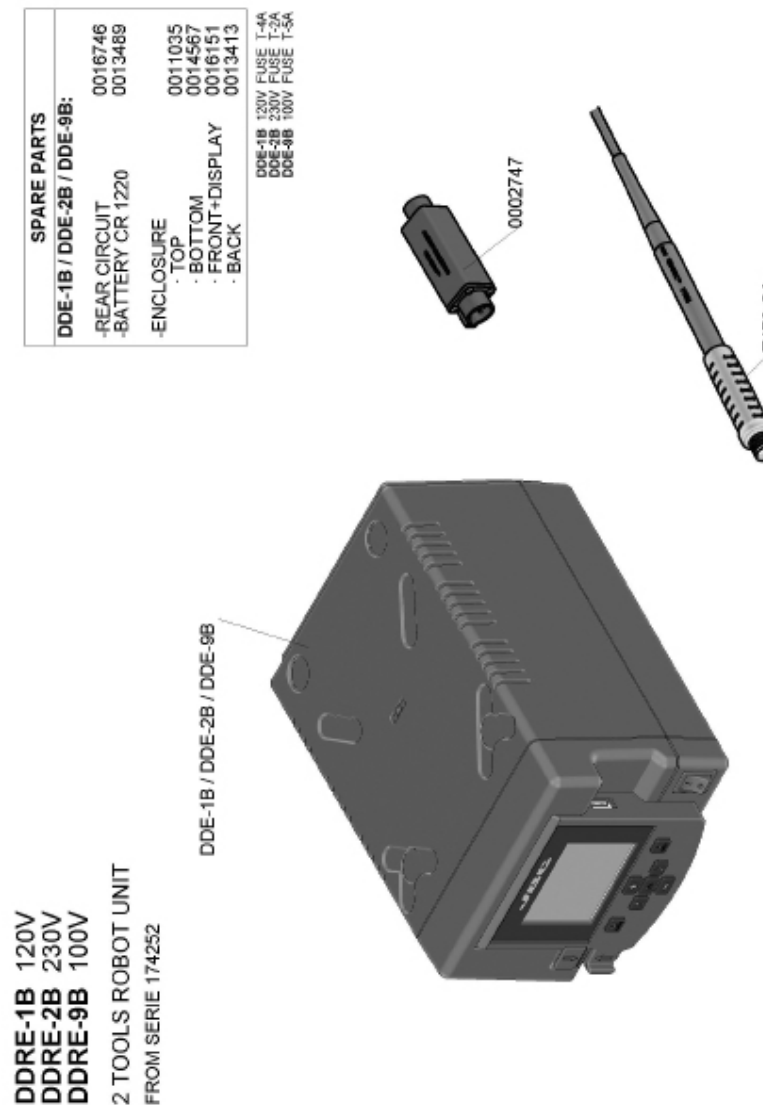

Specifications

DDE-1B 120V 50/60Hz. Input fuse: 4A. Output: 23,5V

DDE-2B 230V 50/60Hz. Input fuse: 2A. Output: 23,5V

DDE-9B 100V 50/60Hz. Input fuse: 5A. Output: 23,5V

- Weight: 4.3 Kg (9.3 lb)
- Dimensions: 148 x 120 x 232 mm
- Output Peak Power: 150W per tool
- Temperature Range: 90-450 °C (190-840 °F)
- Idle Temp. Stability (still air) ± 1.5 °C (± 3 °F)
- Tip to ground resistance: < 2 ohms
- Tip to ground voltage: < 2 mV RMS
- Ambient Operating Temperature: 10-40 °C (50-104 °F)
- USB-A / USB-B / Peripherals connectors
- RJ12 connector for Robot

Complies with CE standards

ESD protected housing "skin effect"

JBC

Warranty

JBC's 2 year warranty covers this equipment against all manufacturing defects, including the replacement of defective parts and labour.

Warranty does not cover product wear due to use or mis-use.

In order for the warranty to be valid, equipment must be returned, postage paid, to the dealer where it was purchased.



This product should not be thrown in the garbage.

In accordance with the European directive 2002/96/EC, electronic equipment at the end of their life must be collected and returned to an authorized recycling facility.