

2

Snap-action switches

S826, S926 Series

Dual changeover switches
with positive opening
operation and
wiping contacts

Catalogue D26.en



More information
schaltbau.com

Snap-action switches S826 Series

Dual changeover switches with positive opening operation and wiping, double-break contacts

Schaltbau S826/S926 series dual changeover switches feature positive opening operation which guarantees the forced disconnection of contacts even when they have become welded together due to a short-circuit.

The contact bridges of the snap-action switches are galvanically isolated allowing two separate load circuits with independent voltage levels to be controlled simultaneously. Wiping, double-break contacts ensure

high reliability even at low electrical loads. Versions with optional gold contacts are particularly suitable for handling low currents and voltages. A defined and repeatable switching action is possible thanks to the snap mechanism whose switching speed is virtually independent of the speed of the button or actuator. That is why snap-action switches are preferred in applications with slow actuation speeds in which they are used, for instance, as motor switches, position switches, or gear limit switches.

Features

Series S826/S926



Variants for extreme conditions: Ruggedized housing made from polyetherimide (PEI). Designed for use in harsh environments. Improved resistance to chemicals, impact and extremes of temperature.



Positive opening operation: Reliable breaking of the normally closed (NC) circuit even if the contacts have become welded together, in compliance with IEC 60947-5-1, Annex K.



Dual changeover switch: Changeover switch with galvanically isolated contact bridges for double-break NC and NO contacts. Thus two separate load circuits can be controlled simultaneously.

Ingress protection rating (IP code): Degrees of protection against dust, humidity, contaminants, or access to hazardous parts to IEC 60529:
Contacts: IP40 / Terminals: IP00



Wiping, double-break contacts: Continuous low contact resistance ensures high contact reliability over the life of the switch.



Contact material: Silver or gold



Switch design and function

Series S826/S926

▶ Actuator

▶ Mounting

▶ Contact area

▶ Terminals

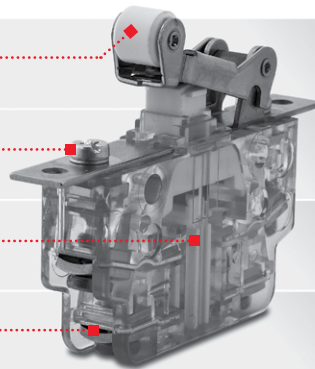

- Standard: push button
- Auxiliary actuator: roller lever

- Front mount
- Side mount (ganging)

- Dual changeover switch, galvanically isolated
- Positive opening operation and self-cleaning contacts
- Contact material: silver or gold

- M3 screws with saddle clamp
- Flat tabs 6.3 x 0.8
- M3 screws with spring washer

S926
Better

Resistance to

- ▶ temperature
- ▶ chemicals
- ▶ impact

Variants for extreme conditions

Schaltbau has developed special variants for use in harsh environments. The S926 Series has a ruggedized housing made from polyetherimide (PEI) that stands for improved resistance to:

- temperatures from -55 °C to +85 °C*
- chemicals (e.g. acids and alkalis)
- impact (PEI more resistant than PC)

The amber, transparent switches are ideally suited for applications where impact forces are high and/or frequent as well as for use in products that are exposed to strong chemicals or extremes of temperature.

The S9xx Series switches have the same design, dimensions and technical features as the switches of the standard S8xx series, allowing for easy replacement and upgrade from a standard switch without additional implementation effort.

Applications

S926 switches are typically used with systems and components that require a high degree of safety and reliability, such as

- Limit switches for machine, door and plant control systems
- Control switches for the driver's desk of rail vehicles or crane consoles
- Switching elements for automation
- Safety limit switches for control systems and plant controls

* dependent on version

Specifications subject to alterations!

Ordering code

Example: **S826 b10/20/40 L**

Series, contact configuration

S826	Dual changeover switch, wiping double-break contacts, positive opening operation, galvanically isolated contact bridges
S926	Same as S826 with improved resistance to chemicals, impact and extremes of temperature

Actuator styles

	Actuator	Mounting
b	Push button	no mounting plates
c	Push button	mounting plates
cs	Push button	mounting plates, slotted
e	Roller lever	no mounting plates
a	Roller lever	mounting plates
as	Roller lever	mounting plates, slotted
d	Roller lever	mounting plates, one angled

Contact material

*	Silver
10	Gold

Special design, optional

Magnetic blowout **L**

Actuating and release force

standard	*
reinforced	40

Terminals

M3 screws with saddle clamp	*
Flat tabs 6.3x0.8	20
Flat tabs 6.3x0.8, angled 90°	24
M3 screws with spring washer	30



Note:
This product catalogue comprises only stock items. For some variants minimum quantities apply. Please ask for conditions.

Special variants:
If you need a special variant of the switch, please do not hesitate to contact us. Maybe the type of switch you are looking for is among our many special designs. If not, we can also supply customized designs. In this case minimum quantities apply.

* No index

S826 / S926



S826 b / S926 b
Push button (standard), silver contacts and M3 screws with saddle clamp



S826 c / S926 c
Push button (standard), mounting brackets, silver contacts and M3 screws with saddle clamp



S826 b20 / S926 b20
Push button (standard), silver contacts and flat tabs 6.3 x 0.8



S826 a / S926 a
Roller lever, mounting brackets, silver contacts and M3 screws with saddle clamp



S826 e20 / S926 e20
Roller lever, silver contacts and flat tabs 6.3 x 0.8

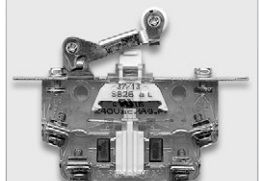





S826 a L / S926 a L
Roller lever, mounting brackets, silver contacts, M3 screws with saddle clamp, and magnetic blowout

Parameter	Identification	Version
IP rating: contacts / terminals		IP40/20
Actuator styles		
▶ Push button (standard), no mounting plates	b	
▶ Push button, mounting plates	c	
▶ Push button, mounting plates, slotted	cs	
▶ Roller lever, no mounting plates	e	
▶ Roller lever, mounting plates	a	
▶ Roller lever, mounting plates, slotted	as	
▶ Roller lever, mounting plates, slotted, one angled	d	
▶ Series	S826	
▶ Contact material	* / 10	
▶ Actuating and release force	* / 40	
▶ Magnetic blowout (special design)	L	
Terminal styles		
▶ M3 screws with saddle clamp	---	*
▶ Flat tabs 6.3x0.8	20	
▶ Flat tabs 6.3x0.8, angled 90°	24	
▶ M3 screws with spring washer	30	

Specifications

Series S826/S926

Series	Standard	S826 / S926
Contact configuration	IEC 60947	Form Zb SPDT-DB, 2 galvanically isolated contact bridges, 4 terminals
Conventional thermal current I_{th}	IEC 60947 UL 508	10 A at T = 85° C 5 A at T = 85° C
Rated insulation voltage U_i	IEC 60947 UL 508	400 V *1 300 V
Pollution degree	IEC 60947 UL 508	PD3 *1 S826: PD3 / S926: PD2
Rated impulse withstand voltage U_{imp}	IEC 60947	4 kV
Overvoltage category	IEC 60947 UL 508	OV3 OV3
Utilization category for silver contacts *2	IEC 60947 UL 508 *3	AC-15: 230 V AC / 1.0 A / DC-13: 110V DC / 0.5 A AC 240 V / 1 A
Contact gap, typ.	IEC 60947	2x 0.85 mm
Contact force, typ.	IEC 60947	0.4 N min.
Contact resistance, typ. without leads connected	IEC 60947	100 mΩ
Positive opening force *4	IEC 60947	20 N
Actuator travel for positive opening operation	IEC 60947	see page 5
Maximum actuator travel *4	IEC 60947	3.2 mm
Actuating speed	IEC 60947	1 m/s max. 0.5 mm/s min.
Vibration resistance, 10 ... 500 Hz all directions (without aux. actuator at 0.1 ms max. opening time)	IEC 60068-2-6	10 g
Shock resistance (without aux. actuator at 0.1 ms max. opening time)	IEC 60068-2-27	30 g, half sinus
Short-circuit protection for silver contacts *2	IEC 60269-2	6 A gR
Max. operating frequency	IEC 60947	465 cycles/minute
Actuating force *4 Standard / reinforced	IEC 60947	3.6 N / 5.5 N
Release force *4 Standard / reinforced	IEC 60947	0.2 N / 2.0 N
Ingress protection rating (IP code) Contacts Terminals	IEC 60529	IP40 IP00
Mechanical endurance	IEC 60947	10 million cycles, min.
Ambient temperature range	IEC 60947	S826: -40 °C ... +85 °C / S926: -55 °C ... +85 °C
Material Contacts Terminals Housing	---	Hard silver (AgCu3) or gold (AuAg26Ni3) Brass, silver-plated or gold plated S826: PC, green, transparent / S926: PEI, amber, transparent
Mounting position	---	any
Weight	---	approx. 18 g
Approvals	---	   



Notes:

Data valid for new switches under laboratory conditions and at room temperature, unless otherwise mentioned.

*1 Valid for flat tab terminal styles. Values for M3 screws terminal styles are: 250 V: PD3 / 400 V: PD2

*2 Data for gold contacts upon request *3 General Purpose *4 Measured next to push button

Dimension diagram, circuit diagram

Series S826/S926

- Dimension diagram S826 b / S926 b SPDT-DB, Form Zb

Circuit diagram

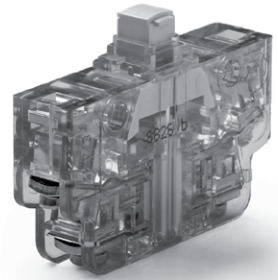
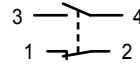
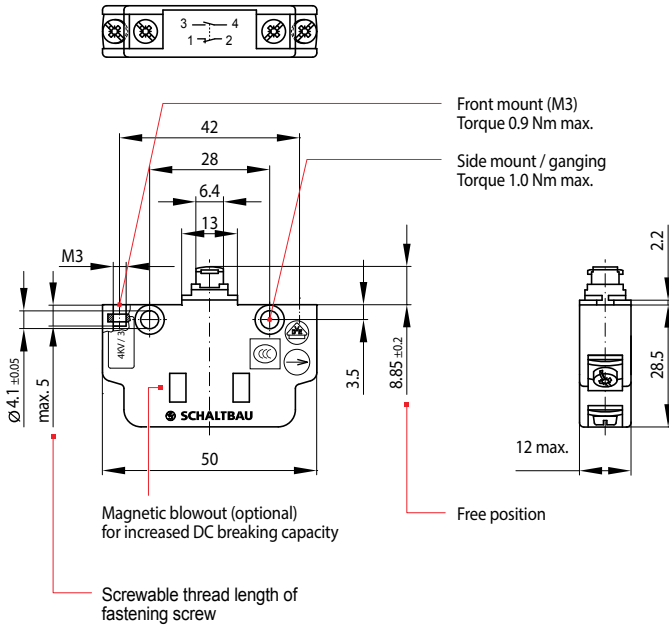

S826 b / S926 b

- S826 b / S926 b Dual changeover switch, double-break contacts, positive opening operation, 2 galvanically isolated contact bridges and wiping contacts
- S826 **b** / S926 **b** Push button (standard)

Actuator styles, actuator positions

Series S826/S926

- S826 / S926, Push button (standard) **b** / **c** / **cs**

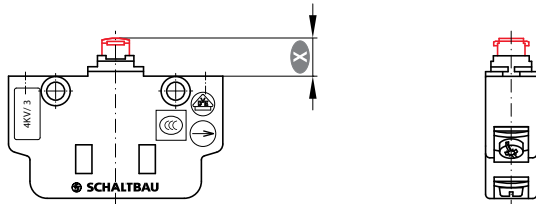

Actuator position	Push button (standard) b / c / cs Actuator travel (X) in mm
Free position	8.85 ± 0.20
Operating position	6.60 ± 0.35
Release position	7.80 ± 0.35
Total positive opening travel	5.80
Total travel position	5.65
Movement differential (between operating and release position)	1.2 (typical)

Note: To ensure proper operation of the positive opening function it is necessary to depress the plunger to the point of total positive opening travel. However, it must not be pushed beyond total travel position. Data is valid for new switches.

- S826 / S926, Roller lever **e** / **a** / **as** / **d**

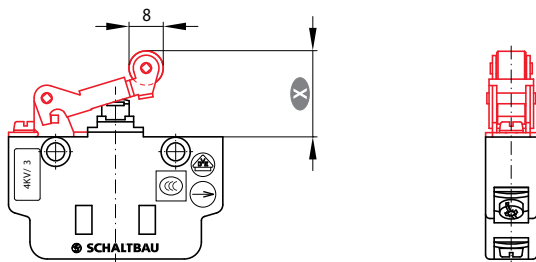

Actuator position	Roller lever e / a / as / d Actuator travel (X) in mm
Free position	20.25 ± 0.35
Operating position	16.50 ± 0.50
Release position	18.50 ± 0.50
Total positive opening travel	13.60
Total travel position	13.3 min.
Movement differential (between operating and release position)	1.8 (typical)

Note: To ensure proper operation of the positive opening function it is necessary to depress the plunger to the point of total positive opening travel. However, it must not be pushed beyond total travel position. Data is valid for new switches.

Mounting Front mount, Ganging

Series S826/S926

Front mount

- **No mounting brackets (standard):** Fastening by way of the retainer nuts (M3) which are fixed in the housing of the switch. Tightening torque 0.9 Nm max.
- **With mounting brackets:** Mounting brackets are available for all actuator options. Tightening torque 0.9 Nm max.
- **Push button (standard) no mounting brackets style [b]**

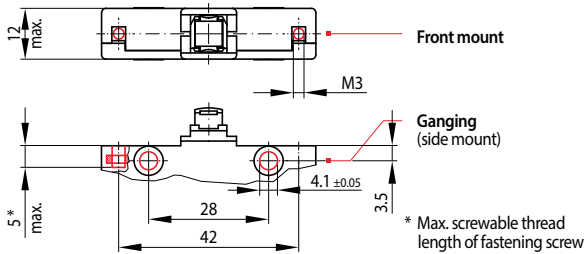

Ganging (side mount)

- Through the two transversal holes in the body of the switch by means of a collar screw or threaded bolt. Tightening torque 1.0 Nm max.
- Alternatively, DUO-Clips or retaining rings can be used.
- **Roller lever without mounting brackets style [e]**

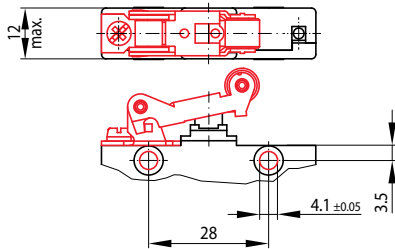

- **Roller lever and mounting brackets style [a]**

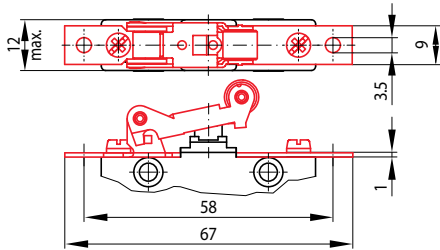

- **Push button and mounting brackets style [c]**

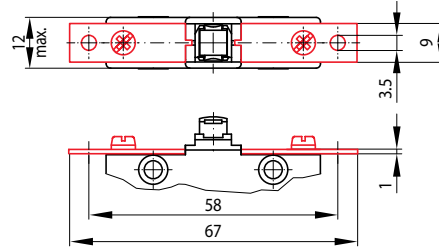

- **Push button and mounting brackets, slotted style [cs]**

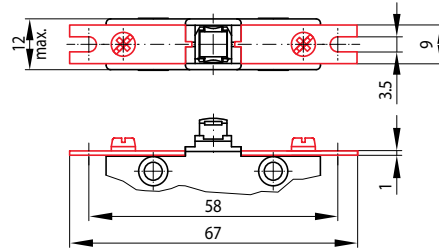

- **Roller lever and mounting brackets, slotted style [as]**

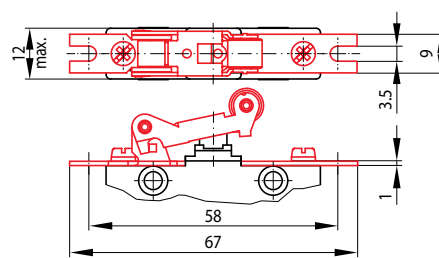

- **Roller lever and mounting bracket, angled style [d]**

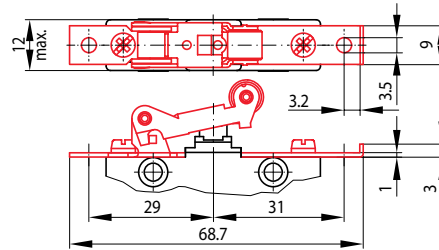

Terminals M3 screws, flat tabs 6,3x0,8

Series S826/S926

- **M3 Screws with saddle clamp (standard) style [1]**

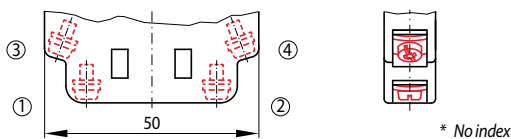

- **M3 Screws with spring washer style [30]**

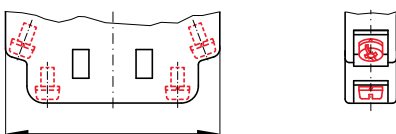

- **Flat tab 6.3x0.8 style [20]**

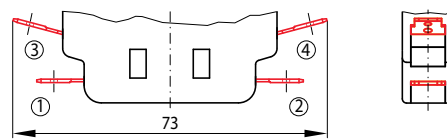

- **Flat tab 6.3x0.8, angled 90° style [24]**

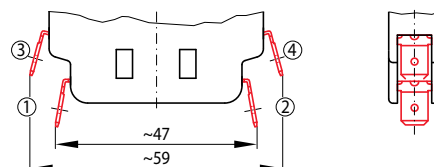

Note:

- Screw terminals for single and multiple-wire conductors: No ferrules AWG 18 ... 12 (0,75 mm² ... 2,5 mm²), with ferrules: AWG 14 (1,5 mm² max.). Max. 2 conductors with the same wire gauge can be clamped per terminal. Tightening torque of terminal screws should be 0.9 Nm max.
- Ingress protection rating (IP code): contacts IP40 / terminals IP00

Mounting Use of roller levers

Series S826/S926

Snap-action switches are designed for actuation with and without a roller lever.

A roller lever is required if the direction of actuation deviates more than $\pm 15^\circ$ from the plunger axis.

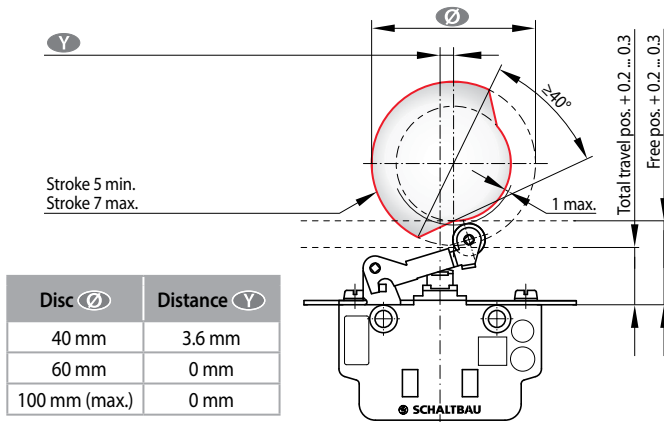
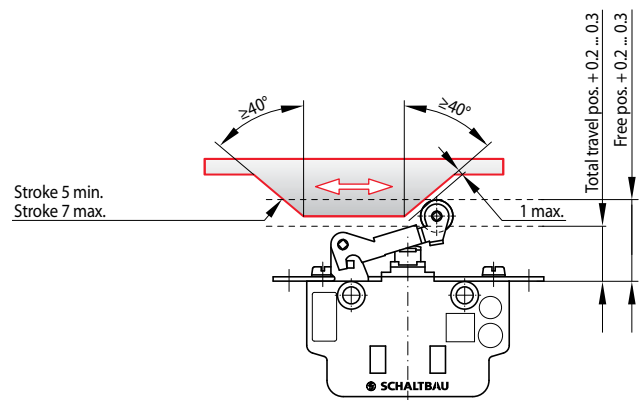
Switch with roller lever actuated by cam disc

Switch with roller lever actuated by linear cam

Mounting and safety instructions, environmental conditions

Series S826/S926

Mounting instructions:

- Snap-action switches should be mounted by qualified professional staff only.
- Observe the required clearance and creepage distances. This is also applicable for connected wires.
- It is necessary to use insulating plates when ganging or mounting switches on uninsulated surfaces.
- The switches can be mounted in any orientation.
- When mounting the switches make sure to use 2 fastening elements (e.g. screws).
- Only use adequate fastening elements such as cylinder head or collar screws or DUO-clips, including washers. When fastening make sure not to exceed the maximum tightening torque.
- When affixing switches with mounting brackets make sure that the mounting surface is level.
- Avoid tilting the screw when mounting to prevent mechanical tension on the housing.
- The actuator should not be pre-tensioned when in the free position. When actuated, the actuator should travel beyond the operating position, for at least 50% of the predefined overtravel, all the way to total travel position.
- To ensure the proper function of the positive opening operation it is necessary to depress the plunger to the total travel position.
- To prevent mechanical destruction of the switch, make sure that actuation of the switch does not exceed the specified total travel position. Avoid using the switch as a mechanical end stop.
- High-impact actuation of the switch can have a negative effect on its mechanical life.
- When securing stripped wire ends in the terminal clamp, make sure the wire insulation is flush with the clamp.
- Prevent a transfer of forces to the switch terminals, and ensure that connected leads have a functioning strain relief.
- When using versions with blowout magnets observe the right polarity, see circuit diagram on the bottom of the switch.

Non-permissible environmental conditions:

- Cleaning agents, adhesives, solvents, or screw-retaining varnish must be compatible with polycarbonate (S826) or polyetherimide (S926) respectively. Never use chemicals not compatible with polycarbonate for S826 Series switches or not compatible with polyetherimide for S926 Series snap-action switches.
- Using such chemicals can result in cracks, deformation, breakage and dissolution of the housing or complete destruction of the respective switch.

Safety instructions:

- Be sure to make regular visual inspections.
- Improper handling of the switch, e. g. when hitting the floor with some impact, can result in breakage, visible cracks and deformation.
- The switch suitability has to be confirmed by the customer for the specific application, and under application conditions.



Defective parts must be replaced immediately!



For a detailed list of all safety, installation and maintenance instructions see here:

➔ schaltbau.info/download2en!

Standards

Series S826/S926

- **IEC 60947-1:** Low-voltage switchgear and controlgear, Part 1: General rules
- **IEC 60947-5-1, Annex K:** Special requirements for control switches with direct opening action
- **UL508:** Industrial control equipment
- **IEC 60529:** Degrees of protection provided by enclosures (IP Code)
- **UL 94V-0:** Flammability Standard
- **DIN 41636-6:** Sensitive switches for communication technology; dimensions, type F
- **ISO 13849-1:** Safety of machinery - Safety-related parts of control systems - Part 1: General principles for design
- **IEC 60068-2-6:** Environmental testing - Part 2-6: Tests - Test Fc: Vibration (sinusoidal)
- **IEC 60068-2-27:** Environmental testing - Part 2-27: Tests - Test Ea and guidance: Shock

Schaltbau GmbH

For detailed information on our products and services visit our website – or give us a call!

Schaltbau GmbH
Hollerithstrasse 5
81829 Munich
Germany



Phone +49 89 9 30 05-0
Fax +49 89 9 30 05-350
Internet www.schaltbau-gmbh.com
e-Mail contact@schaltbau.de

with compliments:



Schaltbau GmbH manufactures in compliance with RoHS.



The production facilities of Schaltbau GmbH have been IRIS certified since 2008.



Certified to DIN EN ISO 14001 since 2002. For the most recent certificate visit our website.



Certified to DIN EN ISO 9001 since 1994. For the most recent certificate visit our website.

Electrical Components and Systems for Railway Engineering and Industrial Applications

Connectors

- Connectors manufactured to industry standards
- Connectors to suit the special requirements of communications engineering (MIL connectors)
- Charging connectors for battery-powered machines and systems
- Connectors for railway engineering, including UIC connectors
- Special connectors to suit customer requirements

Snap-action switches

- Snap-action switches with positive opening operation
- Snap-action switches with self-cleaning contacts
- Enabling switches
- Special switches to suit customer requirements

Contactors

- Single and multi-pole DC contactors
- High-voltage AC/DC contactors
- Contactors for battery powered vehicles and power supplies
- Contactors for railway applications
- Terminal bolts and fuse holders
- DC emergency disconnect switches
- Special contactors to suit customer requirements

Electrics for rolling stock

- Equipment for driver's cab
- Equipment for passenger use
- High-voltage switchgear
- High-voltage heaters
- High-voltage roof equipment
- Equipment for electric brakes
- Design and engineering of train electrics to customer requirements