

## CLH Series



The CLH Series is a type of ceramic chip inductor produced using the multilayer technology. The series provides excellent Q factor and SRF characteristics and is suitable for high frequency applications.

### Features

- RoHS compliant
- Excellent Q factor and SRF characteristics
- Small size of 1005/1608 is suitable for small portable devices
- Supports operating frequency up to 6GHz with nominal inductance values from 1.0nH to 470nH.

### Applications

- RF resonance and impedance matching circuit
- RF and wireless communication
- Information technology equipment, computers, telecommunications, radar detectors, automotive electronics, cellular phones, pagers, PDAs, keyless remote systems
- L-C filter configurations

### Product Identification

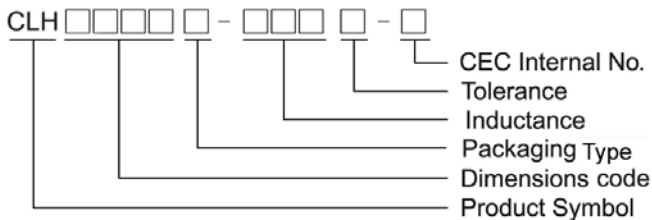

- Packing Type: T: Taping B: Bulk
- Product series identification:

CLH0603-F: Top side half mark.  
 CLH1005-S: Top side full mark.      CLH1005-H: Top side half mark.  
 CLH1608-S: Top side full mark.      CLH1608-H: Top side half mark.  
 CLH2012-S: White

### Shape and Dimensions

CLH0603-F Series  
 CLH1005-H Series  
 CLH1608-H Series

CLH1005-S Series  
 CLH1608-S Series

CLH2012-S Series

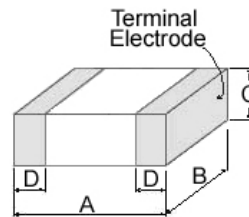
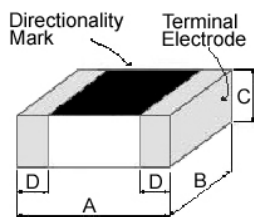
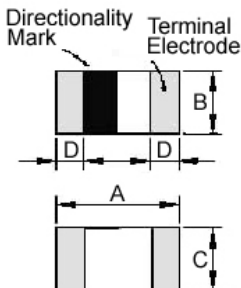

### Recommended Pattern

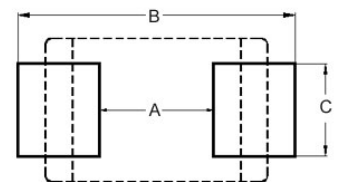

Dimensions in mm

TYPE	A	B	C	D
0603	0.6±0.03	0.3±0.03	0.3±0.03	0.15±0.05
1005	1.0±0.10	0.5±0.10	0.5±0.10	0.25±0.10
1608	1.6±0.15	0.8±0.15	0.8±0.15	0.3±0.2
2012 < 390 nH	2.0±0.2	1.25±0.2	0.9±0.2	0.5±0.3
2012 ≥ 390 nH	2.0±0.2	1.25±0.2	1.2±0.2	0.5±0.3

Dimensions in mm

TYPE	A	B	C
CLH0603	0.3	0.75 ~ 1.05	0.3
CLH1005	0.4	1.2 ~ 1.4	0.5
CLH1608	0.7 ~ 0.8	1.8 ~ 2.0	0.6 ~ 0.8
CLH2012	1.0 ~ 1.2	2.6 ~ 4.0	1.0 ~ 1.2

## Electrical Characteristics

Part Number	Inductance (nH)	Tolerance (±%)	Test Frequency (MHz)	Q Min	SRF (MHz) Min	RDC (Ω) Max	Rated Current (mA) Max
CLH0603T-1N0□-F	1.0	±0.3nH	100	4	>10000	0.11	470
CLH0603T-1N2□-F	1.2	±0.3nH	100	4	>10000	0.12	450
CLH0603T-1N5□-F	1.5	±0.3nH	100	4	>10000	0.13	430
CLH0603T-1N8□-F	1.8	±0.3nH	100	4	>10000	0.16	390
CLH0603T-2N0□-F	2.0	±0.3nH	100	4	>10000	0.17	380
CLH0603T-2N2□-F	2.2	±0.3nH	100	4	8800	0.19	360
CLH0603T-2N4□-F	2.4	±0.3nH	100	4	8300	0.20	350
CLH0603T-2N7□-F	2.7	±0.3nH	100	4	7700	0.21	340
CLH0603T-3N0□-F	3.0	±0.3nH	100	4	7200	0.22	330
CLH0603T-3N3□-F	3.3	±0.3nH	100	4	6700	0.23	320
CLH0603T-3N6□-F	3.6	±0.3nH	100	4	6400	0.25	310
CLH0603T-3N9□-F	3.9	±0.3nH	100	4	6000	0.27	300
CLH0603T-4N3□-F	4.3	±0.3nH	100	4	5700	0.30	280
CLH0603T-4N7□-F	4.7	±0.3nH	100	4	5300	0.30	280
CLH0603T-5N1□-F	5.1	±0.3nH	100	4	5000	0.33	270
CLH0603T-5N6□-F	5.6	±0.3nH	100	4	4600	0.36	260
CLH0603T-6N2□-F	6.2	±0.3nH	100	4	4200	0.38	250
CLH0603T-6N8□-F	6.8	5	100	4	3900	0.39	250
CLH0603T-7N5□-F	7.5	5	100	4	3600	0.41	240
CLH0603T-8N2□-F	8.2	5	100	4	3400	0.45	230
CLH0603T-9N1□-F	9.1	5	100	4	3200	0.48	220
CLH0603T-10N□-F	10	5	100	4	2900	0.51	220
CLH0603T-12N□-F	12	5	100	4	2700	0.68	190
CLH0603T-15N□-F	15	5	100	4	2300	0.71	180
CLH0603T-18N□-F	18	5	100	4	2100	0.81	170
CLH0603T-22N□-F	22	5	100	4	1800	1.00	150
CLH0603T-27N□-F	27	5	100	4	1800	1.35	120
CLH0603T-33N□-F	33	5	100	4	1700	1.47	110
CLH0603T-39N□-F	39	5	100	4	1500	1.72	100
CLH0603T-47N□-F	47	5	100	4	1300	1.90	100
CLH0603T-56N□-F	56	5	100	4	1100	2.27	80
CLH0603T-68N□-F	68	5	100	4	1100	2.66	80
CLH0603T-82N□-F	82	5	100	4	1000	3.37	70
CLH0603T-R10□-F	100	5	100	4	900	3.74	60

**Note: When ordering, please specify tolerance code. Tolerance : S=±0.3nH , J=±5%**

- Operating temperature range - 55°C ~ 125°C(Including self - temperature rise)
- Rate Current :Applied the current to coils, the temperature rise shall not be more than 30°C
- Measure Equipment :
  - L & Q : Agilent E4991A+Agilent 16197A
  - SRF : Agilent E4991A or HP19196C
  - RDC : HP4338B or CHEN HWA 502

## Test Instruments : Agilent E4991A Material/Impedance Analyzer

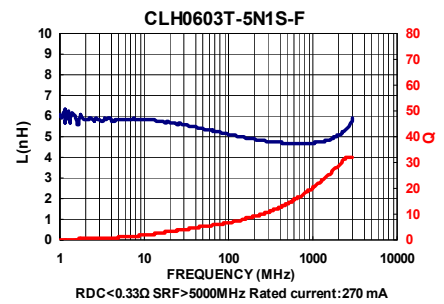
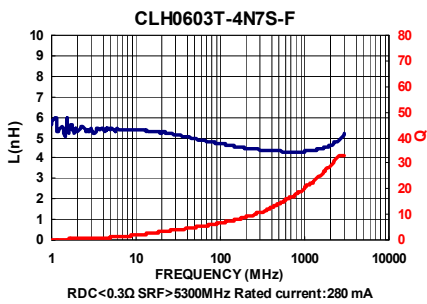
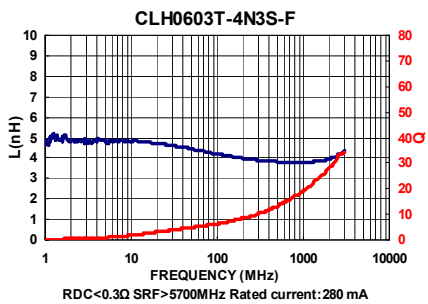
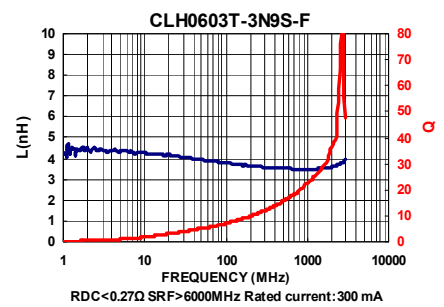
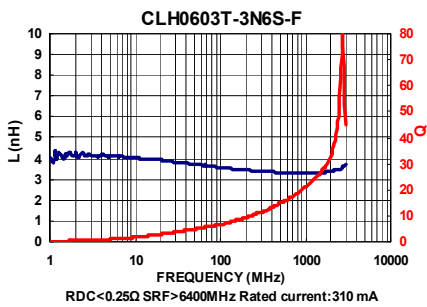
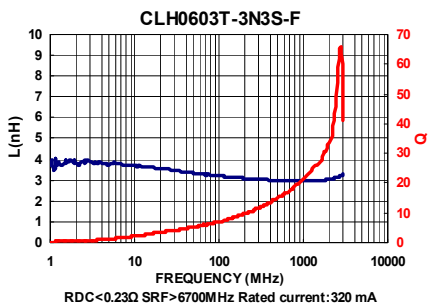
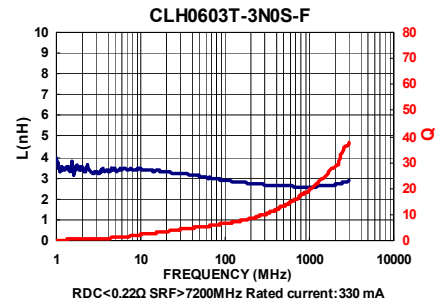
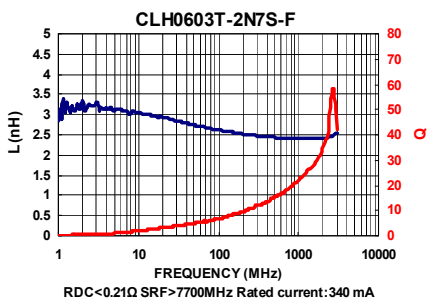
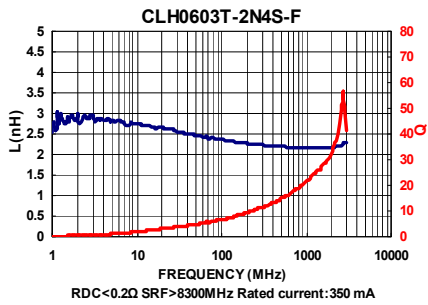
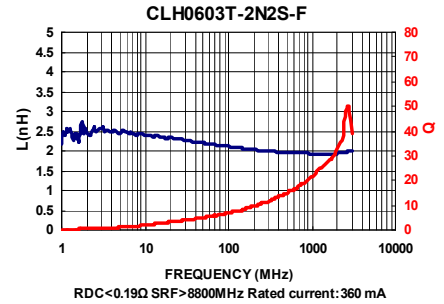
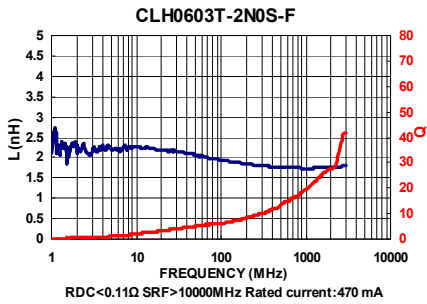
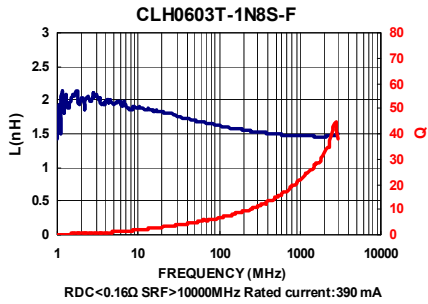
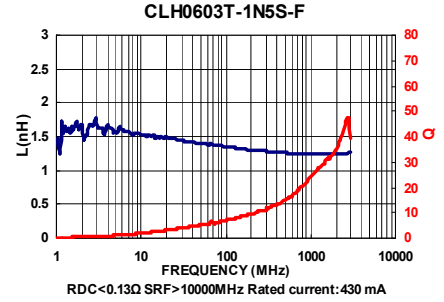
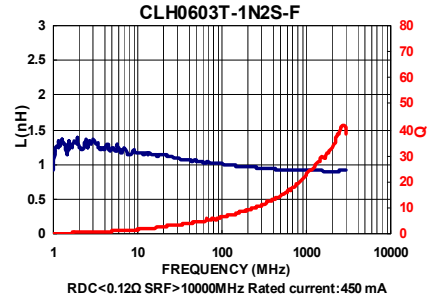
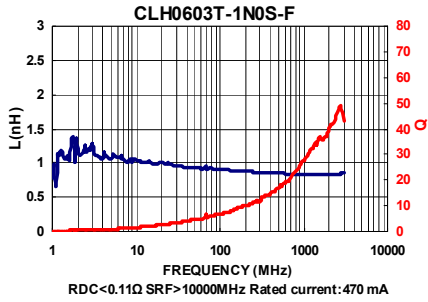

## Test Instruments : Agilent E4991A Material/Impedance Analyzer

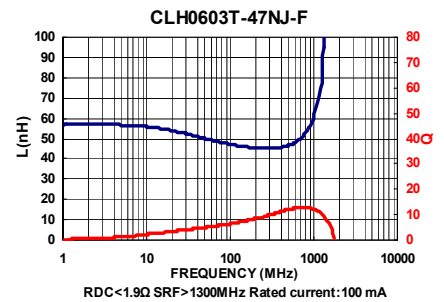
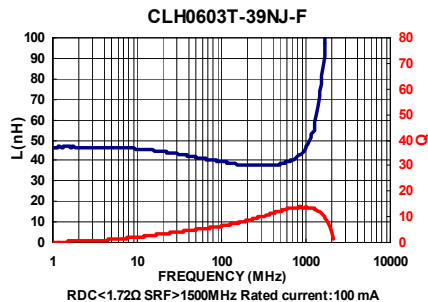
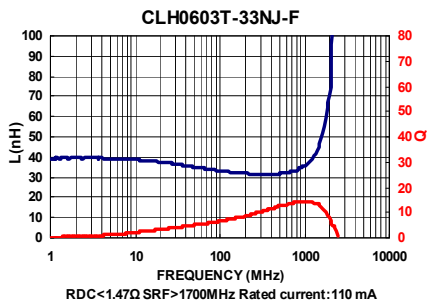
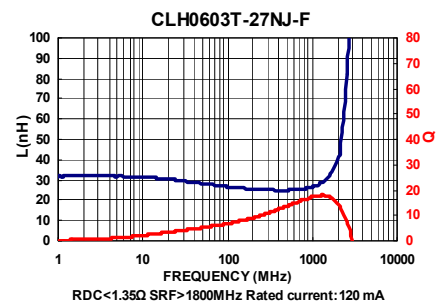
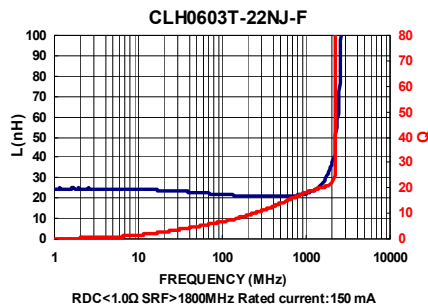
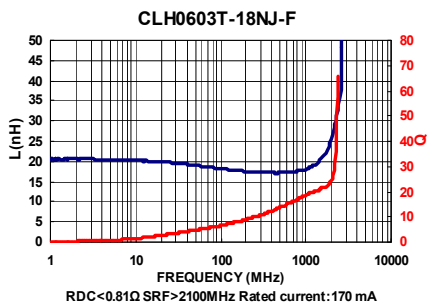
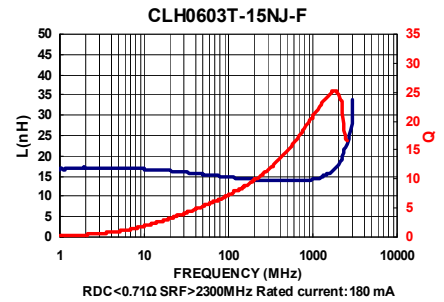
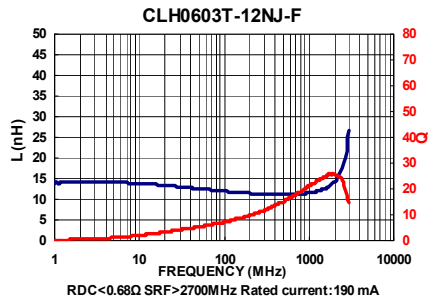
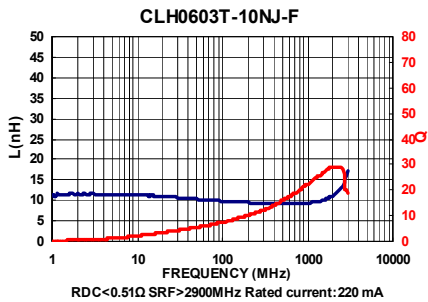
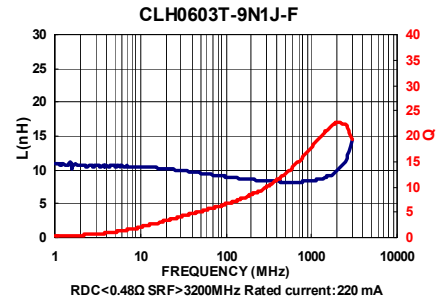
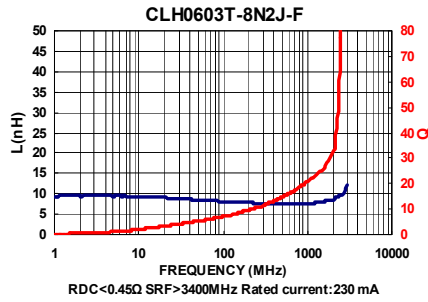
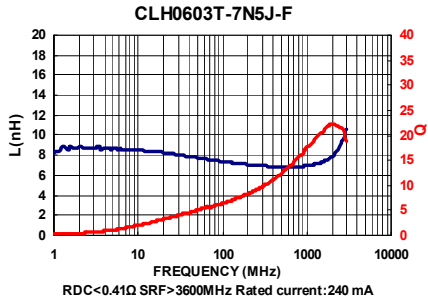
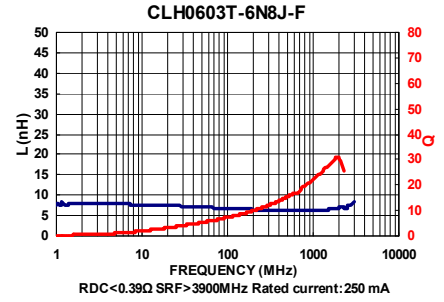
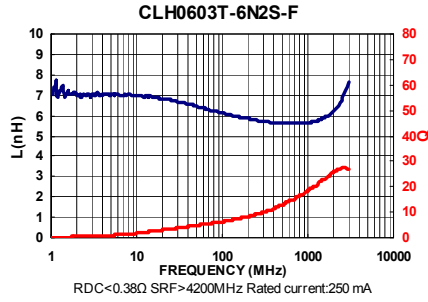
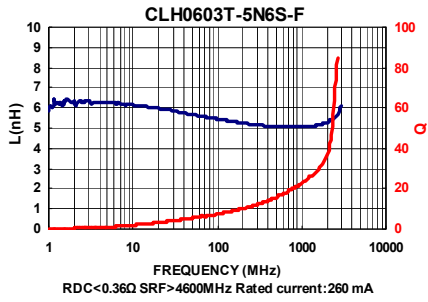

Test Instruments : Agilent E4991A Material/Impedance Analyzer

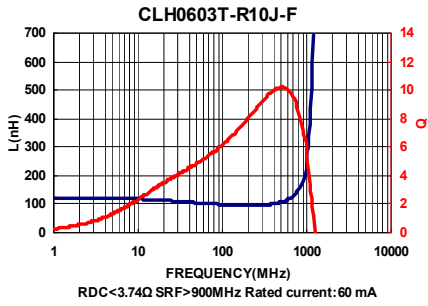
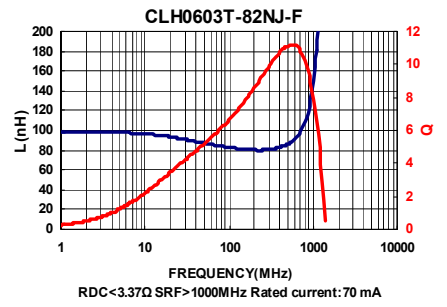
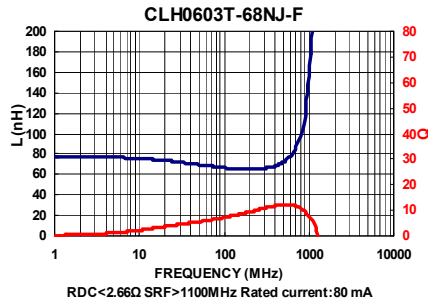
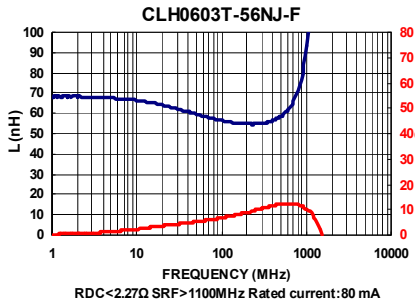

## Electrical Characteristics

Part Number	Inductance (nH)	Tolerance (±%)	Test Frequency (MHz)	Q Min	SRF (MHz) Typ.	RDC (Ω) Max	IDC (mA) Max
CLH1005T-1N0□-S	1.0	±0.3nH	100	8	10000	0.07	400
CLH1005T-1N2□-S	1.2	±0.3nH	100	8	10000	0.09	400
CLH1005T-1N5□-S	1.5	±0.3nH	100	8	9000	0.10	400
CLH1005T-1N8□-S	1.8	±0.3nH	100	8	8700	0.10	400
CLH1005T-2N0□-S	2.0	±0.3nH	100	8	8100	0.10	400
CLH1005T-2N2□-S	2.2	±0.3nH	100	8	8100	0.12	400
CLH1005T-2N4□-S	2.4	±0.3nH	100	8	7700	0.15	400
CLH1005T-2N7□-S	2.7	±0.3nH	100	8	7700	0.15	400
CLH1005T-3N0□-S	3.0	±0.3nH	100	8	6300	0.15	400
CLH1005T-3N3□-S	3.3	±0.3nH/10	100	8	6300	0.15	400
CLH1005T-3N6□-S	3.6	±0.3nH/10	100	8	6100	0.15	400
CLH1005T-3N9□-S	3.9	±0.3nH/10	100	8	6100	0.18	400
CLH1005T-4N3□-S	4.3	±0.3nH/10	100	8	6000	0.18	400
CLH1005T-4N7□-S	4.7	±0.3nH/10	100	8	6000	0.18	400
CLH1005T-5N6□-S	5.6	±0.3nH/10	100	8	5100	0.20	400
CLH1005T-6N8□-S	6.8	5 / 10	100	8	4550	0.24	400
CLH1005T-8N2□-S	8.2	5 / 10	100	8	4100	0.24	300
CLH1005T-10N□-S	10	5 / 10	100	8	3900	0.26	300
CLH1005T-12N□-S	12	5 / 10	100	8	3000	0.40	300
CLH1005T-15N□-S	15	5 / 10	100	8	2800	0.50	300
CLH1005T-18N□-S	18	5 / 10	100	8	2500	0.55	300
CLH1005T-22N□-S	22	5 / 10	100	8	2200	0.70	300
CLH1005T-27N□-S	27	5 / 10	100	8	2000	0.80	300
CLH1005T-33N□-S	33	5 / 10	100	8	1800	0.9	200
CLH1005T-39N□-S	39	5 / 10	100	8	1600	1.0	150
CLH1005T-47N□-S	47	5 / 10	100	8	1400	1.2	150
CLH1005T-56N□-S	56	5 / 10	100	8	1300	1.3	150
CLH1005T-68N□-S	68	5 / 10	100	8	1100	1.5	100
CLH1005T-82N□-S	82	5 / 10	100	8	1000	1.6	100
CLH1005T-R10□-S	100	5 / 10	100	8	900	2.0	100

**Note:** When ordering, please specify tolerance code. Tolerance : S=±0.3nH , J=±5% , K=±10%

- Operating temperature range - 55°C ~ 125°C(Including self - temperature rise)
- IDC : Applied the current to coils, the inductance shall be less than 10% initial value
- Measure Equipment :  
 L & Q : Agilent E4991A+Agilent 16197A  
 SRF : HP8753D  
 RDC : HP4338B or CHEN HWA 502

## Test Instruments : Agilent E4991A Material/Impedance Analyzer

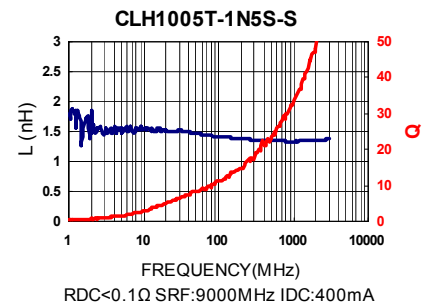
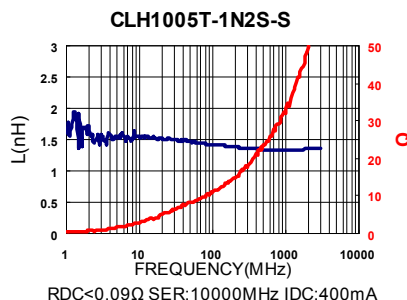
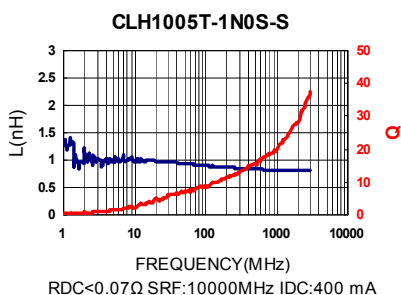

Test Instruments : Agilent E4991A Material/Impedance Analyzer

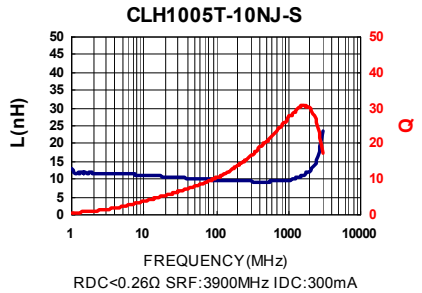
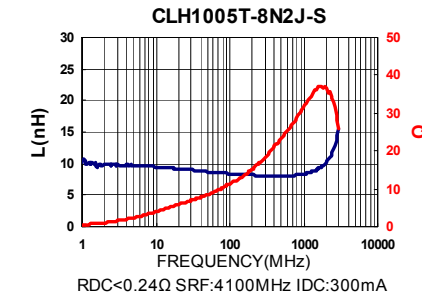
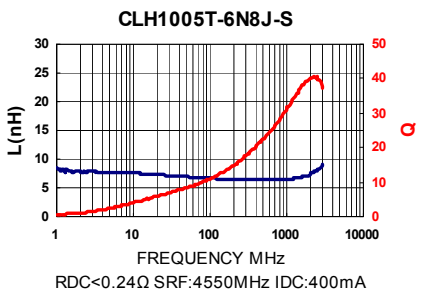
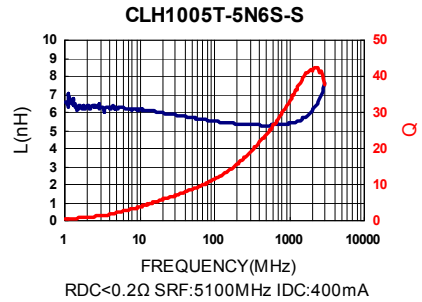
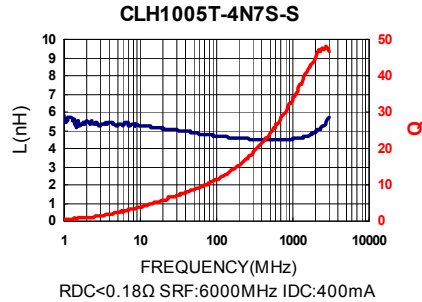
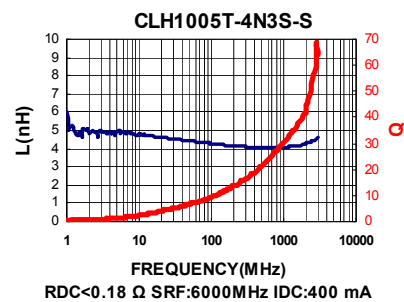
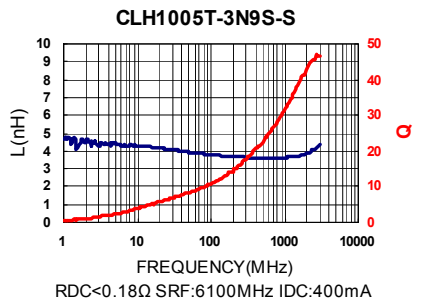
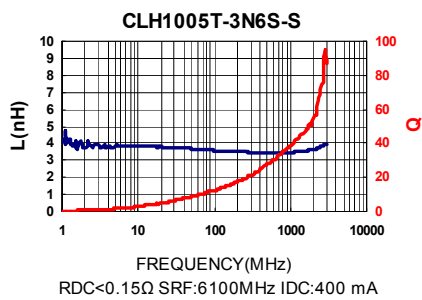
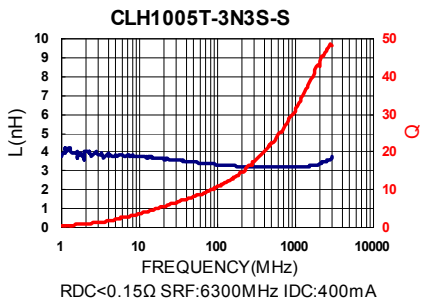
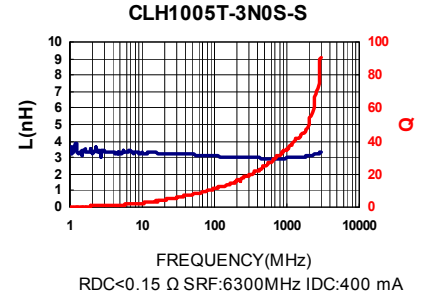
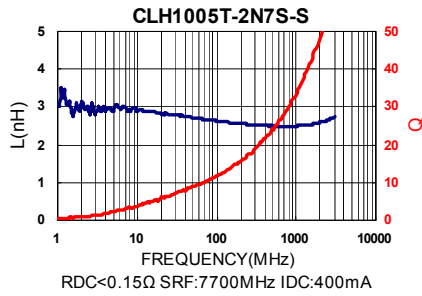
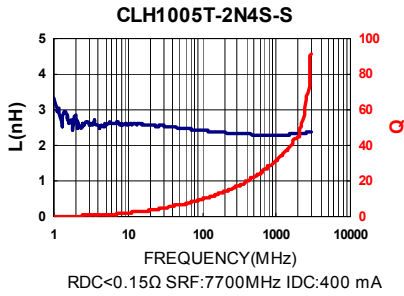
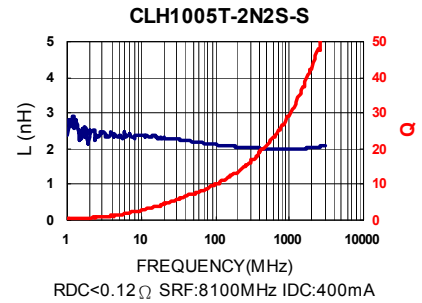
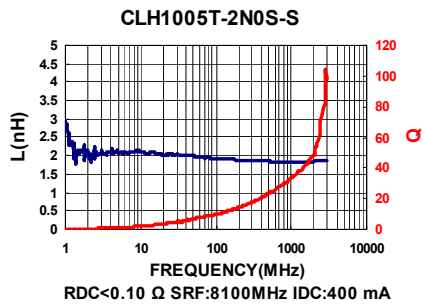
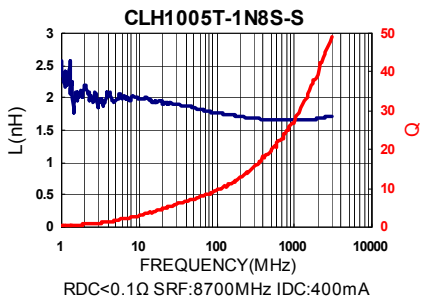

Test Instruments : Agilent E4991A Material/Impedance Analyzer

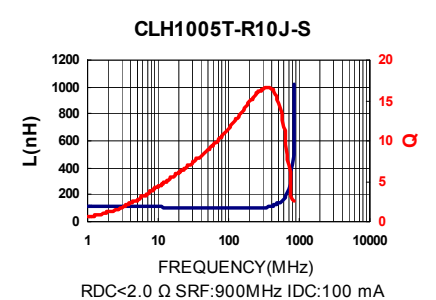
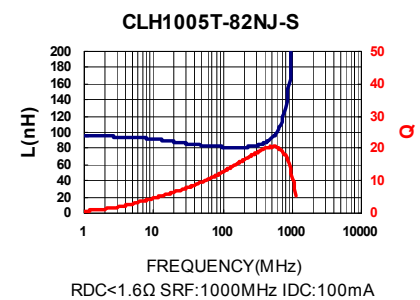
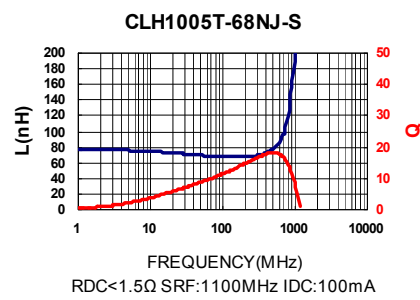
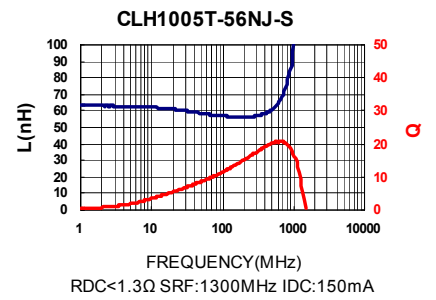
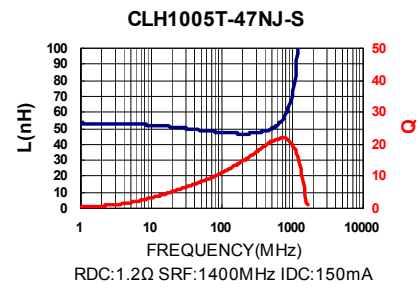
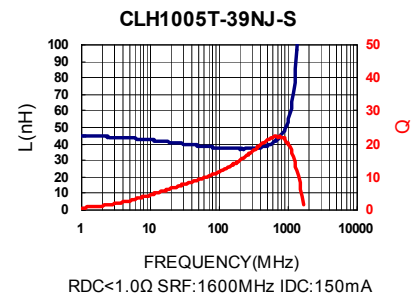
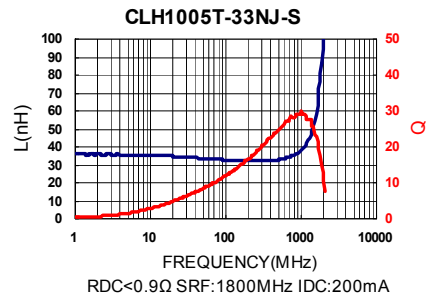
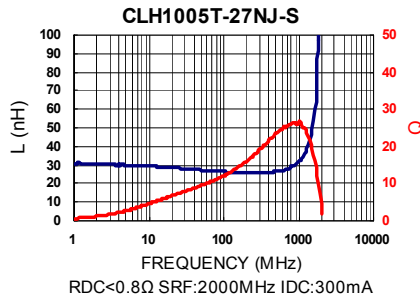
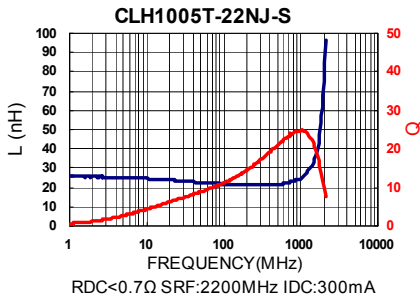
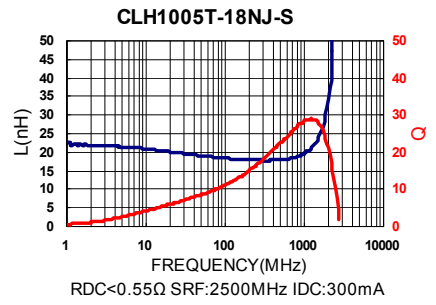
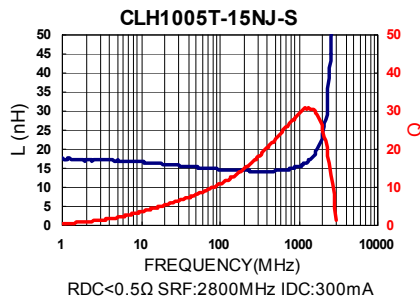
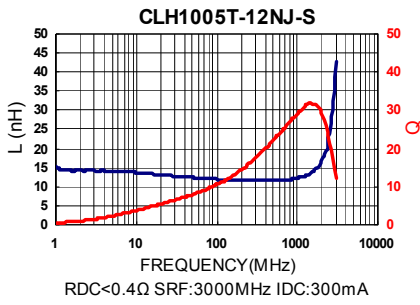



## Electrical Characteristics

Part Number	Inductance (nH)	Tolerance (±%)	Test Frequency (MHz)	Q Min	SRF (MHz) Typ.	RDC (Ω) Max	IDC (mA) Max
CLH1005T-1N0□-H	1.0	±0.3nH	100	8	10000	0.07	400
CLH1005T-1N2□-H	1.2	±0.3nH	100	8	10000	0.09	400
CLH1005T-1N5□-H	1.5	±0.3nH	100	8	9000	0.10	400
CLH1005T-1N8□-H	1.8	±0.3nH	100	8	8700	0.10	400
CLH1005T-2N2□-H	2.2	±0.3nH	100	8	8100	0.12	400
CLH1005T-2N7□-H	2.7	±0.3nH	100	8	7700	0.15	400
CLH1005T-3N0□-H	3.0	±0.3nH	100	8	6300	0.15	400
CLH1005T-3N3□-H	3.3	±0.3nH/10	100	8	6300	0.15	400
CLH1005T-3N9□-H	3.9	±0.3nH/10	100	8	6100	0.18	400
CLH1005T-4N7□-H	4.7	±0.3nH/10	100	8	6000	0.18	400
CLH1005T-5N6□-H	5.6	±0.3nH/10	100	8	5100	0.20	400
CLH1005T-6N8□-H	6.8	5 / 10	100	8	4550	0.24	400
CLH1005T-8N2□-H	8.2	5 / 10	100	8	4100	0.24	300
CLH1005T-10N□-H	10	5 / 10	100	8	3900	0.26	300
CLH1005T-12N□-H	12	5 / 10	100	8	3000	0.40	300
CLH1005T-15N□-H	15	5 / 10	100	8	2800	0.50	300
CLH1005T-18N□-H	18	5 / 10	100	8	2500	0.55	300
CLH1005T-22N□-H	22	5 / 10	100	8	2200	0.70	300
CLH1005T-27N□-H	27	5 / 10	100	8	2000	0.80	300
CLH1005T-33N□-H	33	5 / 10	100	8	1800	0.9	200
CLH1005T-39N□-H	39	5 / 10	100	8	1600	1.0	150
CLH1005T-47N□-H	47	5 / 10	100	8	1400	1.2	150
CLH1005T-56N□-H	56	5 / 10	100	8	1300	1.3	150
CLH1005T-68N□-H	68	5 / 10	100	8	1100	1.5	100
CLH1005T-82N□-H	82	5 / 10	100	8	1000	1.6	100
CLH1005T-R10□-H	100	5 / 10	100	8	900	2.0	100
CLH1005T-R12□-H	120	5 / 10	100	8	800	2.2	100
CLH1005T-R15□-H	150	5 / 10	100	8	700	3.5	100
CLH1005T-R18□-H	180	5 / 10	100	8	600	3.8	100
CLH1005T-R22□-H	220	5 / 10	100	8	500	4.2	100
CLH1005T-R27□-H	270	5 / 10	100	8	500	4.8	100

**Note:** When ordering, please specify tolerance code. Tolerance : S=±0.3nH , J=±5% , K=±10%

- Operating temperature range - 55°C ~ 125°C(Including self - temperature rise)
- IDC : Applied the current to coils, the inductance shall be less than 10% initial value
- Measure Equipment :  
 L & Q : Agilent E4991A+Agilent 16197A  
 SRF : HP8753D  
 RDC : HP4338B or CHEN HWA 502

**Test Instruments :** Agilent E4991A Material/Impedance Analyzer

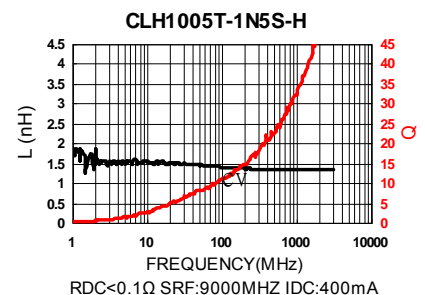
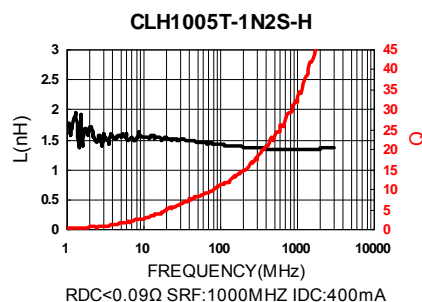
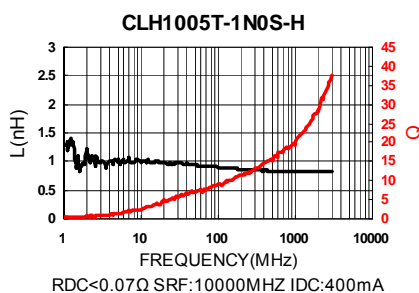

Test Instruments : Agilent E4991A Material/Impedance Analyzer

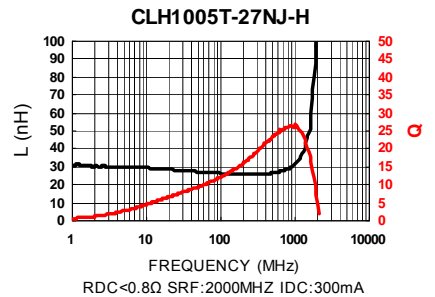
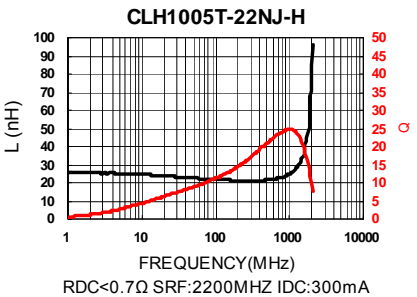
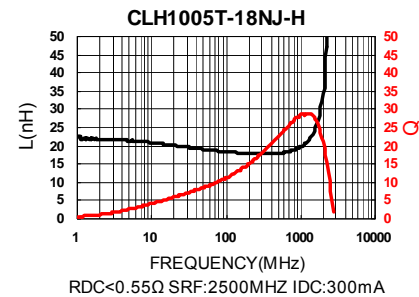
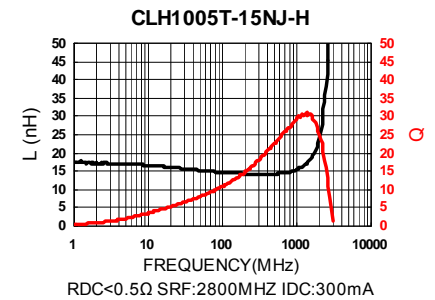
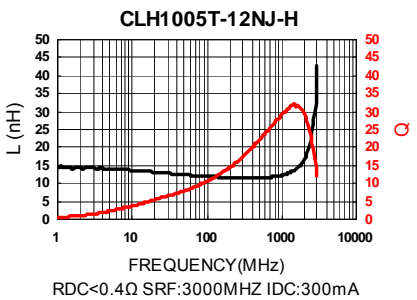
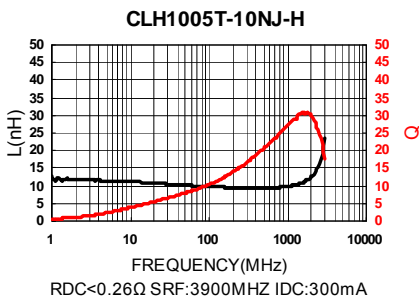
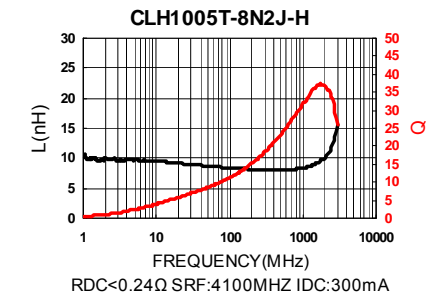
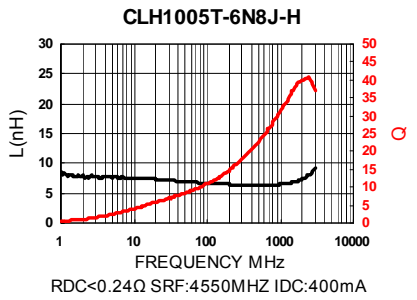
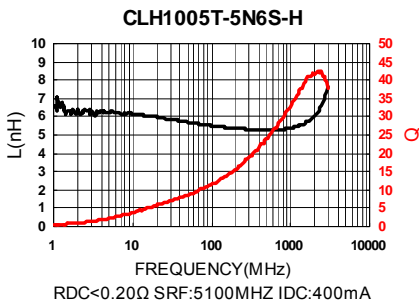
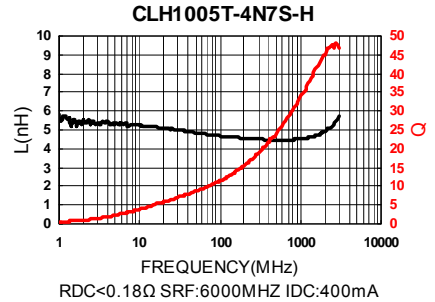
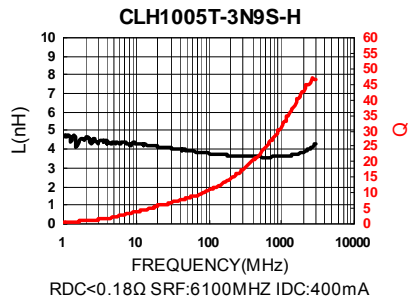
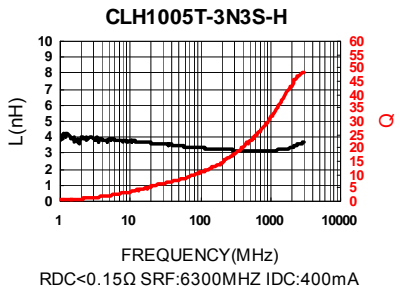
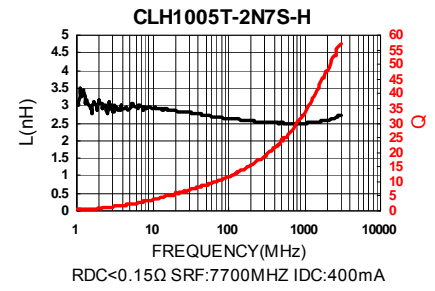
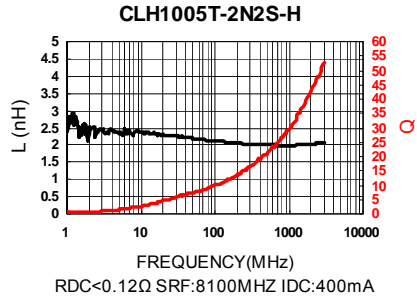
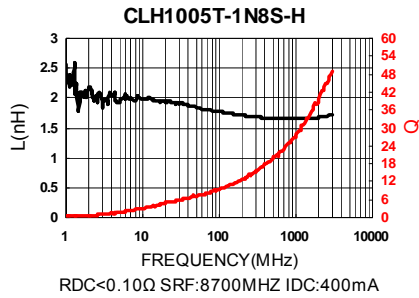

Test Instruments : Agilent E4991A Material/Impedance Analyzer

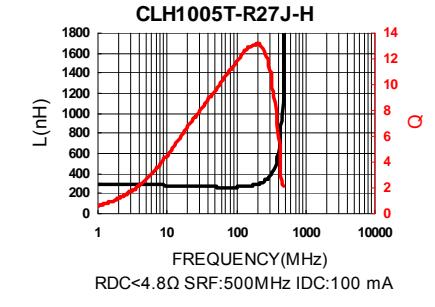
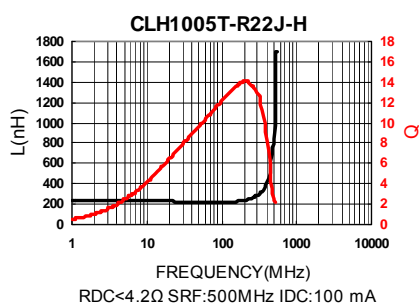
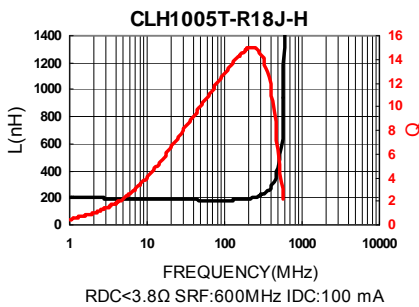
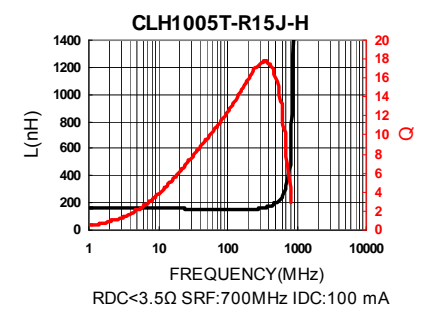
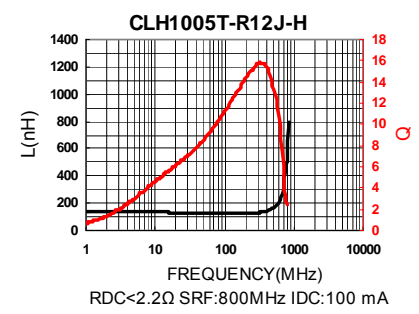
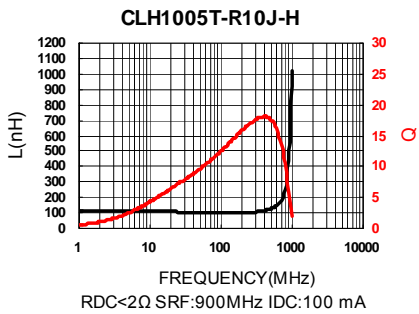
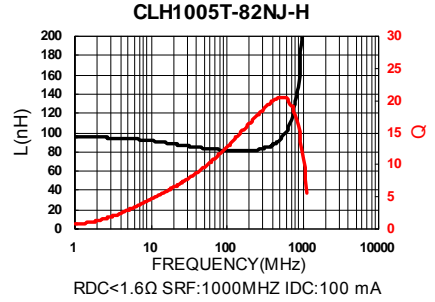
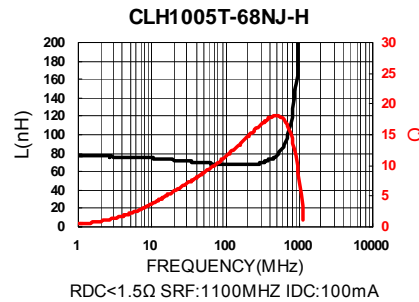
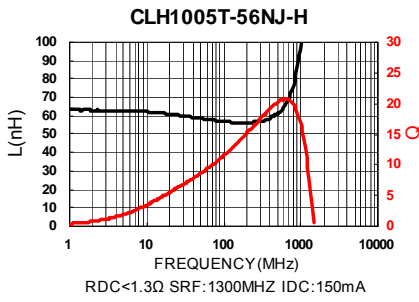
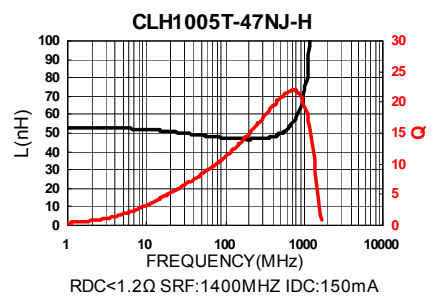
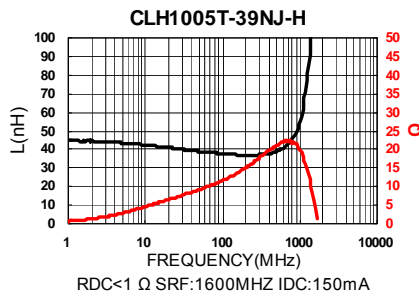
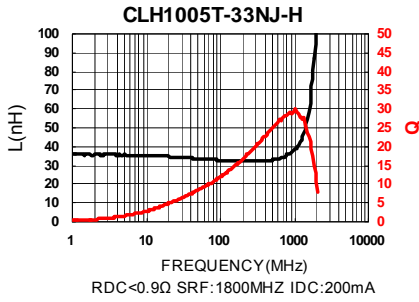

## Electrical Characteristics

Part Number	Inductance (nH)	Tolerance (±%)	Test Frequency (MHz)	Q Min	SRF (MHz) Typ.	RDC (Ω) Max	Rated Current (mA) Max
CLH1005T-1N0□-S-NP	1.0	±0.3nH	100	8	10000	0.07	400
CLH1005T-1N2□-S-NP	1.2	±0.3nH	100	8	10000	0.09	400
CLH1005T-1N5□-S-NP	1.5	±0.3nH	100	8	9000	0.10	400
CLH1005T-1N8□-S-NP	1.8	±0.3nH	100	8	8700	0.10	400
CLH1005T-2N0□-S-NP	2.0	±0.3nH	100	8	8100	0.10	400
CLH1005T-2N2□-S-NP	2.2	±0.3nH	100	8	8100	0.12	400
CLH1005T-2N4□-S-NP	2.4	±0.3nH	100	8	7700	0.15	400
CLH1005T-2N7□-S-NP	2.7	±0.3nH	100	8	7700	0.15	400
CLH1005T-3N0□-S-NP	3.0	±0.3nH	100	8	6300	0.15	400
CLH1005T-3N3□-S-NP	3.3	±0.3nH	100	8	6300	0.15	400
CLH1005T-3N6□-S-NP	3.6	±0.3nH	100	8	6100	0.15	400
CLH1005T-3N9□-S-NP	3.9	±0.3nH	100	8	6100	0.18	400
CLH1005T-4N3□-S-NP	4.3	±0.3nH	100	8	6000	0.18	400
CLH1005T-4N7□-S-NP	4.7	±0.3nH	100	8	6000	0.18	400
CLH1005T-5N1□-S-NP	5.1	±0.3nH	100	8	5300	0.20	400
CLH1005T-5N6□-S-NP	5.6	±0.3nH	100	8	5100	0.20	400
CLH1005T-6N2□-S-NP	6.2	±0.3nH/5/10	100	8	4500	0.22	400
CLH1005T-6N8□-S-NP	6.8	5 / 10	100	8	4550	0.24	400
CLH1005T-7N5□-S-NP	7.5	5 / 10	100	8	4200	0.24	300
CLH1005T-8N2□-S-NP	8.2	5 / 10	100	8	4100	0.24	300
CLH1005T-9N1□-S-NP	9.1	5 / 10	100	8	3900	0.26	300
CLH1005T-10N□-S-NP	10	5 / 10	100	8	3900	0.26	300
CLH1005T-12N□-S-NP	12	5 / 10	100	8	3000	0.28	300
CLH1005T-15N□-S-NP	15	5 / 10	100	8	2500	0.32	300
CLH1005T-18N□-S-NP	18	5 / 10	100	8	2200	0.36	300
CLH1005T-22N□-S-NP	22	5 / 10	100	8	1900	0.42	300
CLH1005T-27N□-S-NP	27	5 / 10	100	8	1700	0.46	300
CLH1005T-33N□-S-NP	33	5 / 10	100	8	1600	0.58	200
CLH1005T-39N□-S-NP	39	5 / 10	100	8	1200	0.65	200
CLH1005T-47N□-S-NP	47	5 / 10	100	8	1000	0.72	200
CLH1005T-56N□-S-NP	56	5 / 10	100	8	800	0.82	200
CLH1005T-68N□-S-NP	68	5 / 10	100	8	800	0.92	180
CLH1005T-82N□-S-NP	82	5 / 10	100	8	700	1.20	150

**Note: When ordering, please specify tolerance code. Tolerance : S=±0.3nH , J=±5% , K=±10%**

- Operating temperature range - 55°C ~ 125°C(Including self - temperature rise)
- Rate Current : Applied the current to coils, the temperature rise shall not be more than 30°C
- Measure Equipment :  
 L & Q : Agilent E4991A+Agilent 16197A  
 SRF : HP8753D  
 RDC : HP4338B or CHEN HWA 502

## Test Instruments : Agilent E4991A Material/Impedance Analyzer

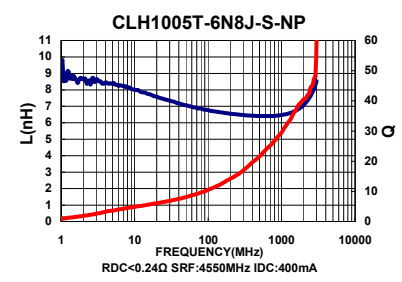
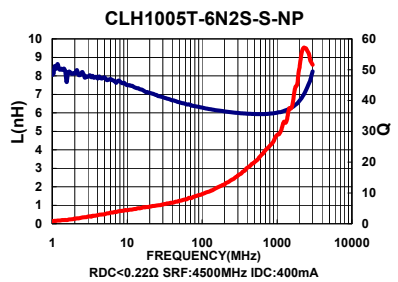
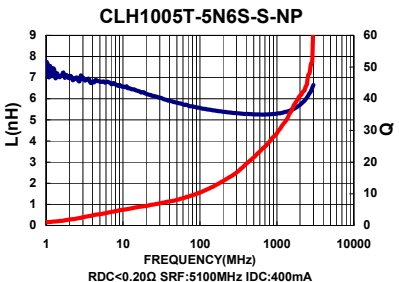
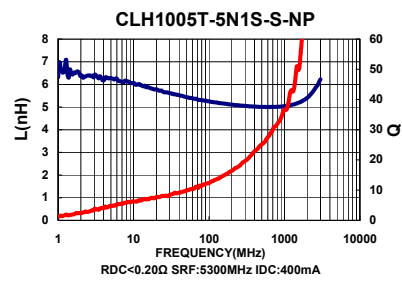
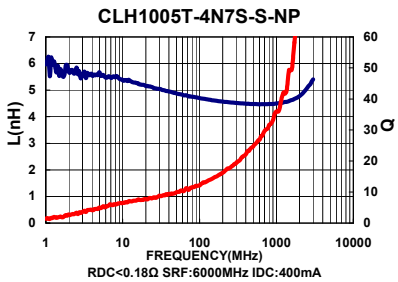
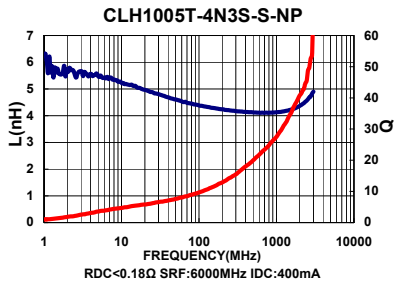
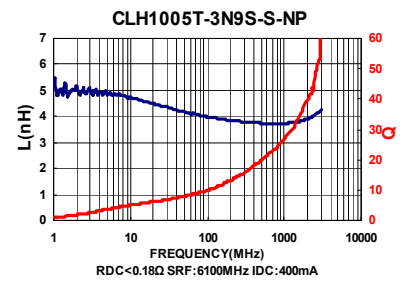
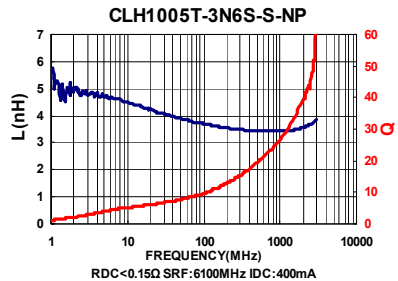
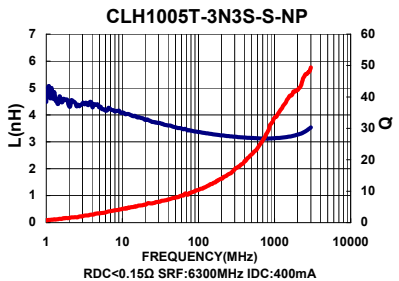
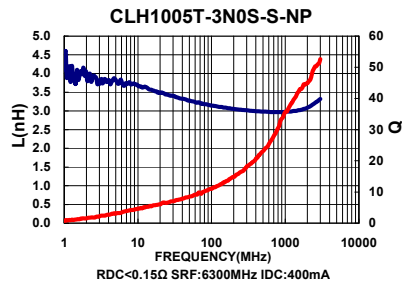
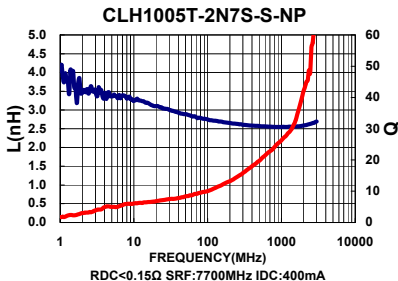
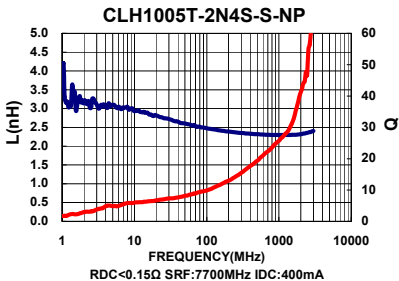
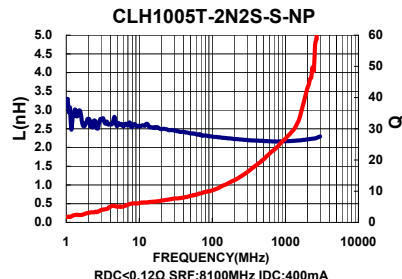
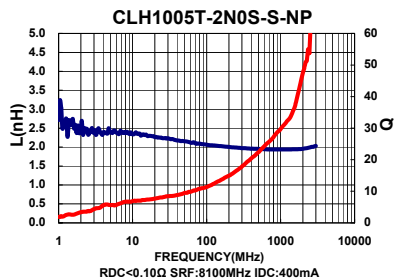
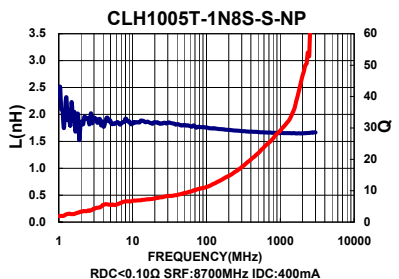
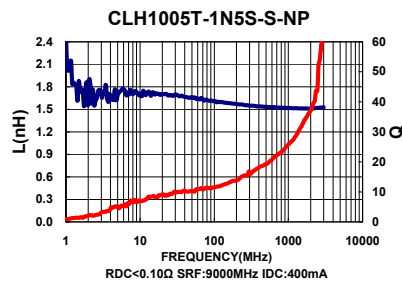
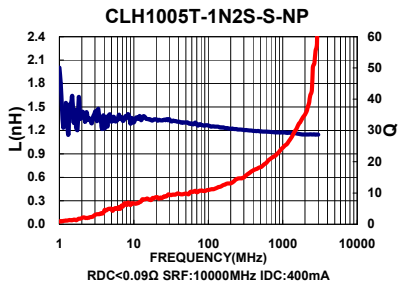
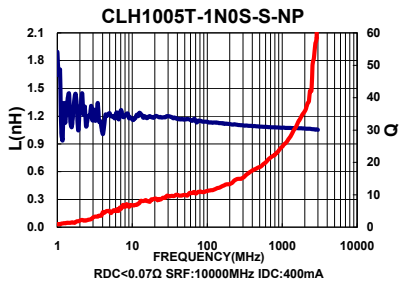

## Test Instruments : Agilent E4991A Material/Impedance Analyzer

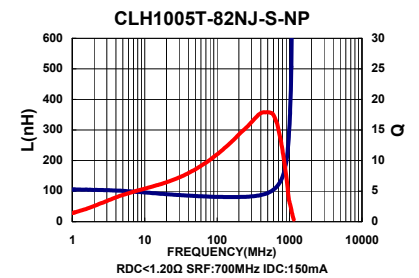
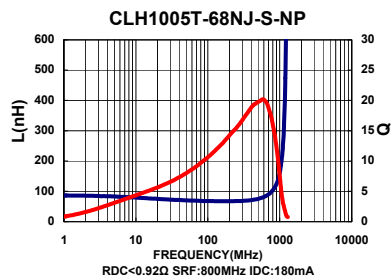
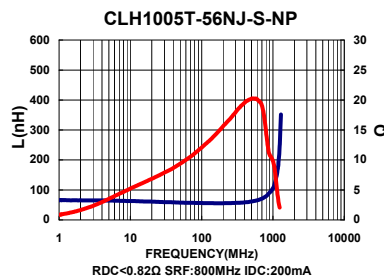
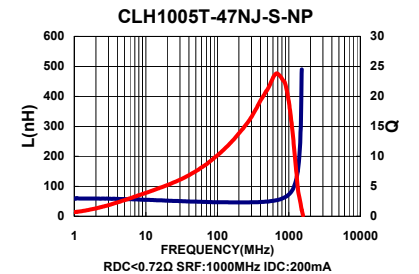
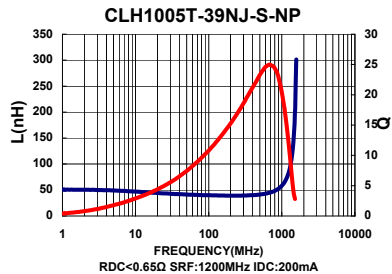
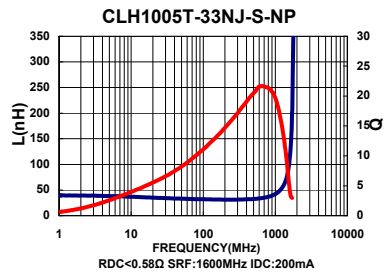
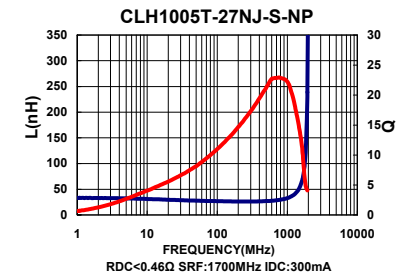
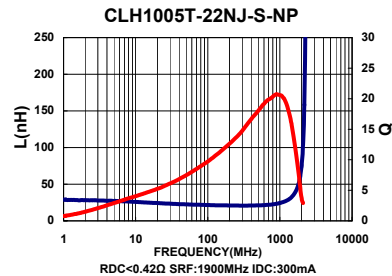
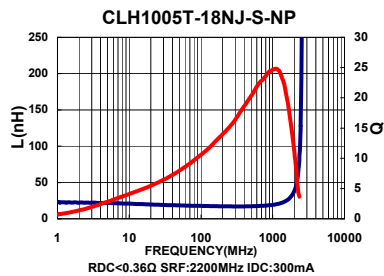
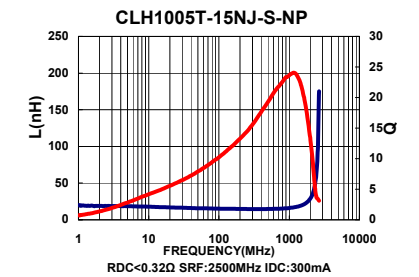
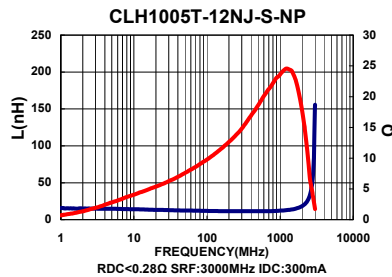
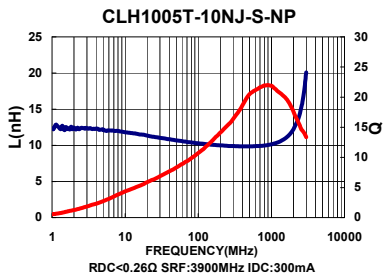
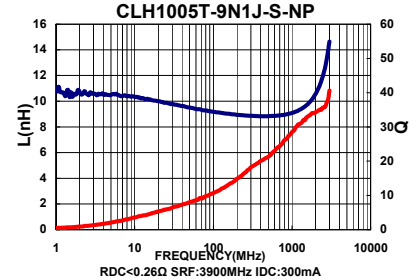
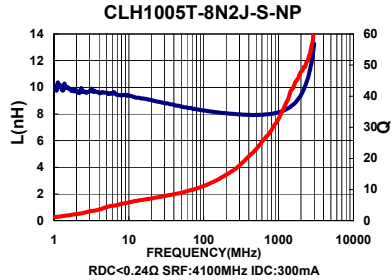
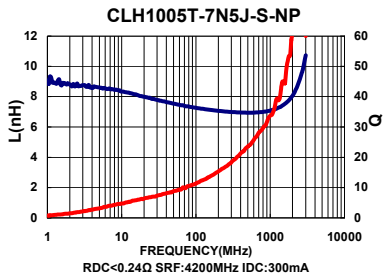

## Electrical Characteristics

Part Number	Inductance (nH)	Tolerance (±%)	Test Frequency (MHz)	Q Min	SRF (MHz) Typ.	RDC (Ω) Max	IDC (mA) Max
CLH1608T-1N0S-S	1.0	±0.3nH	100	8	10000	0.10	600
CLH1608T-1N2S-S	1.2	±0.3nH	100	8	10000	0.10	600
CLH1608T-1N5S-S	1.5	±0.3nH	100	8	8000	0.10	600
CLH1608T-1N8S-S	1.8	±0.3nH	100	8	8000	0.10	600
CLH1608T-2N2S-S	2.2	±0.3nH	100	8	7200	0.10	600
CLH1608T-2N7S-S	2.7	±0.3nH	100	10	6200	0.10	600
CLH1608T-3N3□-S	3.3	±0.3nH/10	100	10	5200	0.12	600
CLH1608T-3N9□-S	3.9	±0.3nH/10	100	10	5000	0.14	600
CLH1608T-4N7□-S	4.7	±0.3nH /10	100	10	4750	0.16	600
CLH1608T-5N6□-S	5.6	±0.3nH/10	100	10	4100	0.18	600
CLH1608T-6N8□-S	6.8	5 / 10	100	10	3750	0.22	600
CLH1608T-8N2□-S	8.2	5 / 10	100	10	3300	0.24	600
CLH1608T-10N□-S	10	5 / 10	100	12	3000	0.26	600
CLH1608T-12N□-S	12	5 / 10	100	12	2600	0.28	600
CLH1608T-15N□-S	15	5 / 10	100	12	2500	0.32	600
CLH1608T-18N□-S	18	5 / 10	100	12	2400	0.35	600
CLH1608T-22N□-S	22	5 / 10	100	12	2000	0.40	500
CLH1608T-27N□-S	27	5 / 10	100	12	1900	0.45	500
CLH1608T-33N□-S	33	5 / 10	100	12	1600	0.55	400
CLH1608T-39N□-S	39	5 / 10	100	12	1400	0.60	400
CLH1608T-47N□-S	47	5 / 10	100	12	1300	0.70	400
CLH1608T-56N□-S	56	5 / 10	100	12	1100	0.75	400
CLH1608T-62N□-S	62	5 / 10	100	12	1050	0.85	400
CLH1608T-68N□-S	68	5 / 10	100	12	1050	0.85	400
CLH1608T-82N□-S	82	5 / 10	100	12	900	1.00	300
CLH1608T-R10□-S	100	5 / 10	100	12	770	1.20	300
CLH1608T-R12□-S	120	5 / 10	50	8	650	1.30	300
CLH1608T-R15□-S	150	5 / 10	50	8	550	1.70	250
CLH1608T-R18□-S	180	5 / 10	50	8	520	1.90	250
CLH1608T-R22□-S	220	5 / 10	50	8	500	2.00	250
CLH1608T-R27□-S	270	5 / 10	50	8	470	2.20	150
CLH1608T-R33□-S	330	5 / 10	50	8	320	2.80	100
CLH1608T-R39□-S	390	5 / 10	50	8	300	3.00	100

**Note:** When ordering, please specify tolerance code. Tolerance : S=±0.3nH , J=±5% , K=±10%

- Operating temperature range - 55°C ~ 125°C(Including self - temperature rise)
- IDC : Applied the current to coils, the inductance shall be less than 10% initial value
- Measure Equipment :
  - L & Q : Agilent E4991A+Agilent 16197A
  - SRF : HP8753D
  - RDC : HP4338B or CHEN HWA 502

## Test Instruments : Agilent E4991A Material/Impedance Analyzer

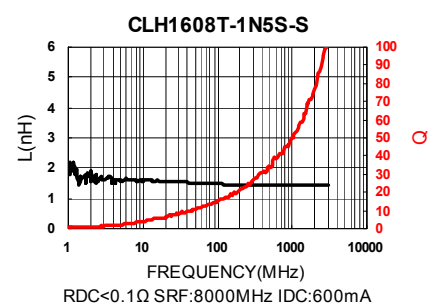
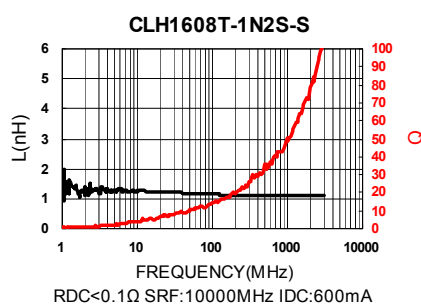
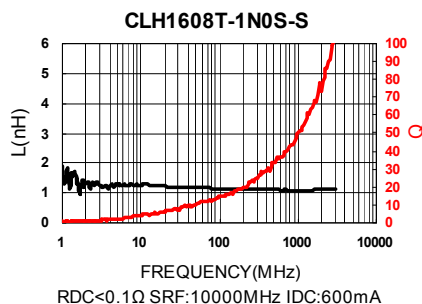



## Test Instruments : Agilent E4991A Material/Impedance Analyzer

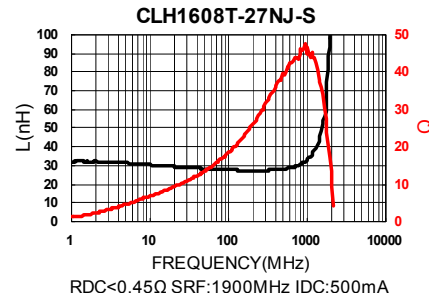
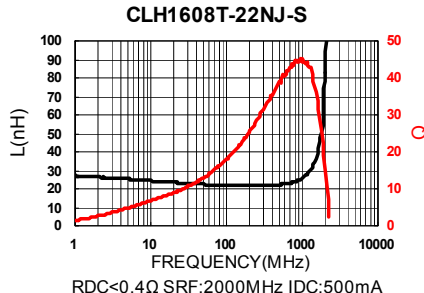
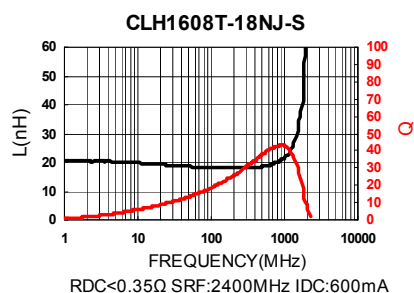
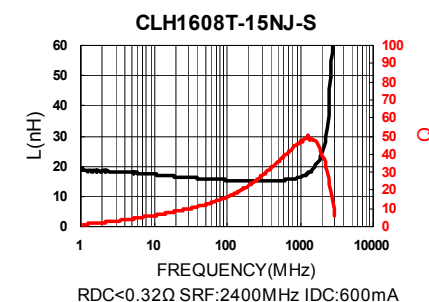
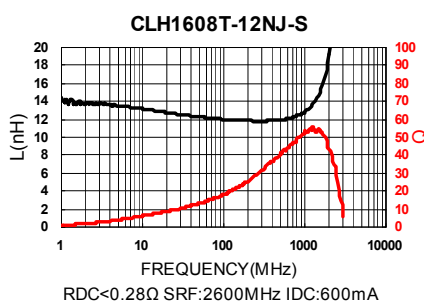
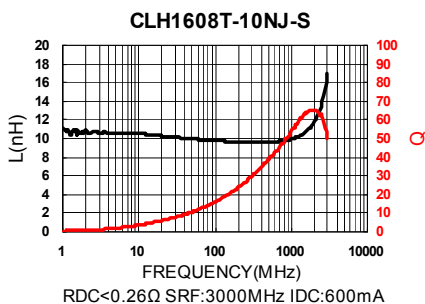
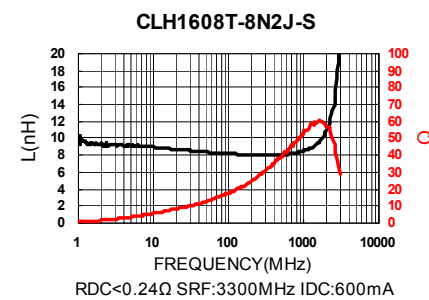
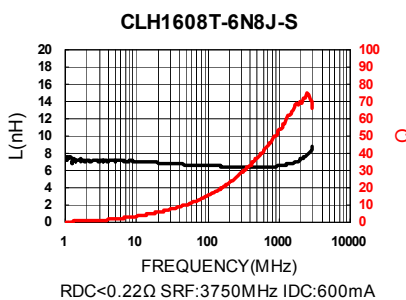
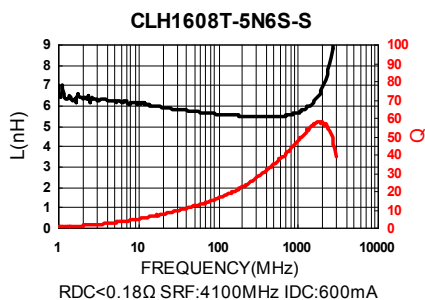
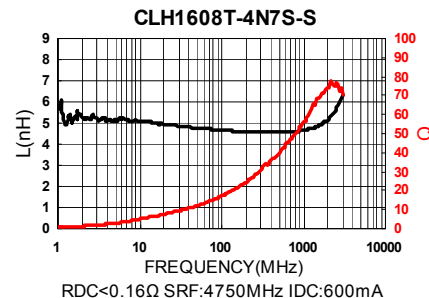
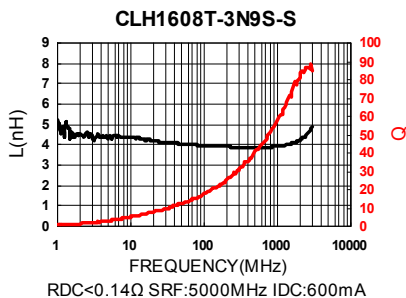
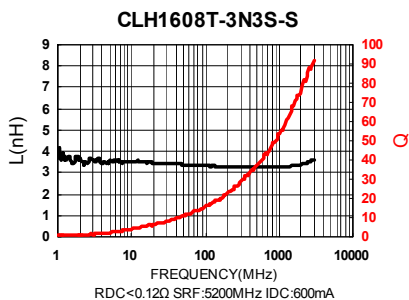
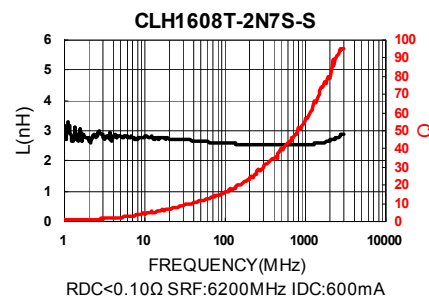
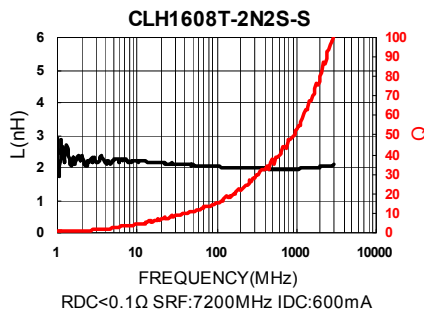
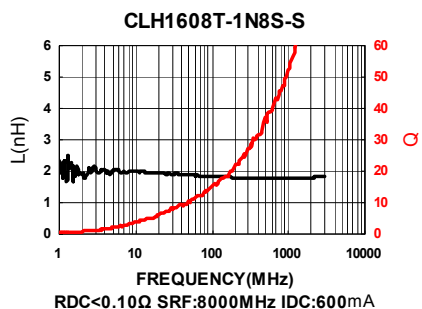



Test Instruments : Agilent E4991A Material/Impedance Analyzer

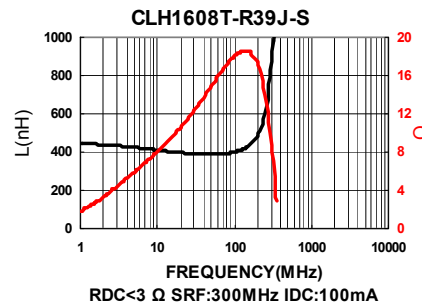
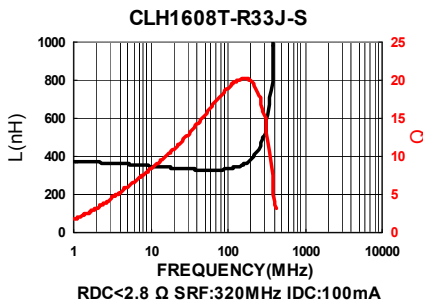
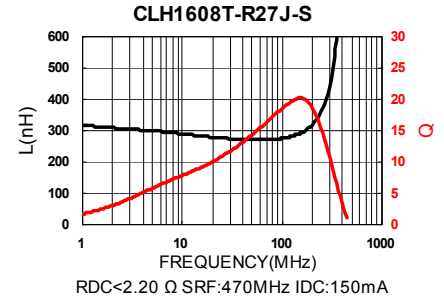
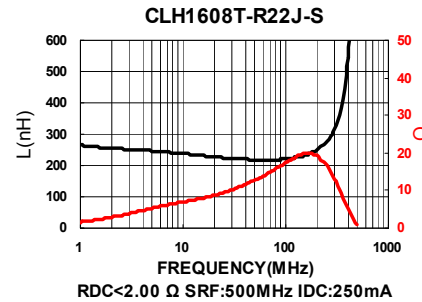
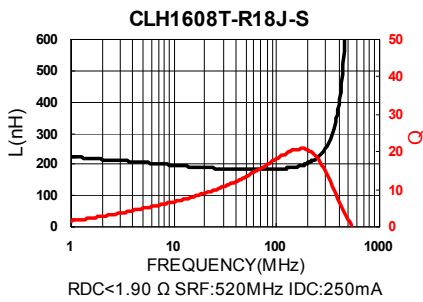
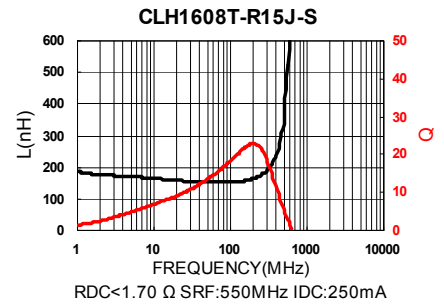
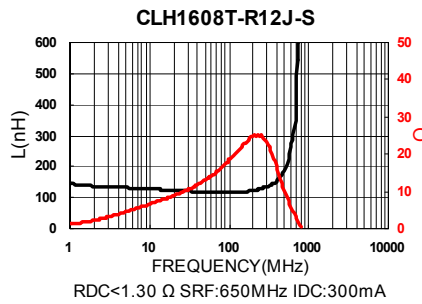
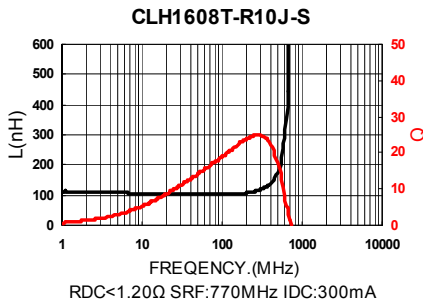
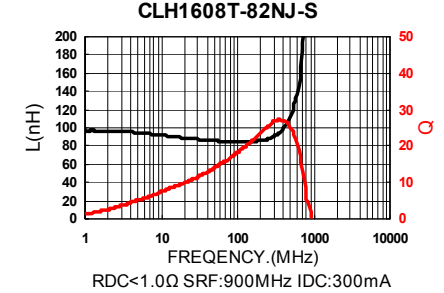
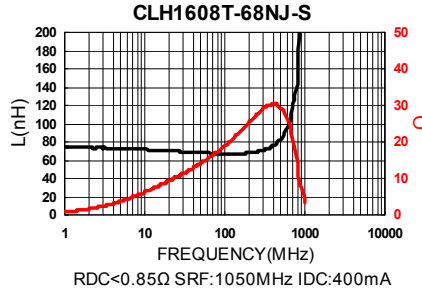
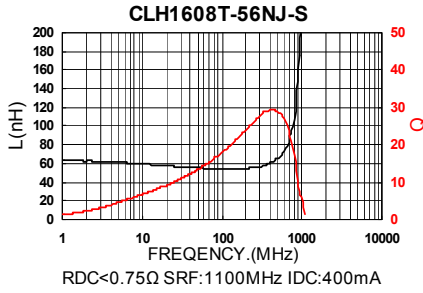
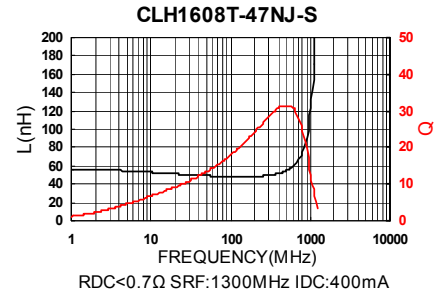
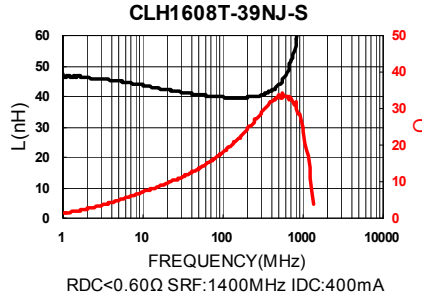
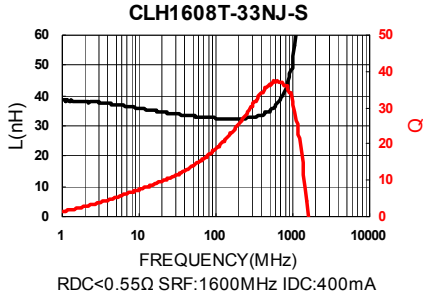

## Electrical Characteristics

Part Number	Inductance (nH)	Tolerance (±%)	Test Frequency (MHz)	Q Min	SRF (MHz) Typ.	RDC (Ω) Max	IDC (mA) Max
CLH1608T-1N0S-H	1.0	±0.3nH	100	8	10000	0.10	600
CLH1608T-1N2S-H	1.2	±0.3nH	100	8	10000	0.10	600
CLH1608T-1N5S-H	1.5	±0.3nH	100	8	8000	0.10	600
CLH1608T-1N8S-H	1.8	±0.3nH	100	8	8000	0.10	600
CLH1608T-2N2S-H	2.2	±0.3nH	100	8	7200	0.10	600
CLH1608T-2N7S-H	2.7	±0.3nH	100	10	6200	0.10	600
CLH1608T-3N3□-H	3.3	±0.3nH/10	100	10	5200	0.12	600
CLH1608T-3N9□-H	3.9	±0.3nH/10	100	10	5000	0.14	600
CLH1608T-4N7□-H	4.7	±0.3nH/10	100	10	4750	0.16	600
CLH1608T-5N6□-H	5.6	±0.3nH/10	100	10	4100	0.18	600
CLH1608T-6N8□-H	6.8	5 / 10	100	10	3750	0.22	600
CLH1608T-8N2□-H	8.2	5 / 10	100	10	3300	0.24	600
CLH1608T-10N□-H	10	5 / 10	100	12	3000	0.26	600
CLH1608T-12N□-H	12	5 / 10	100	12	2600	0.28	600
CLH1608T-15N□-H	15	5 / 10	100	12	2500	0.32	600
CLH1608T-18N□-H	18	5 / 10	100	12	2400	0.35	600
CLH1608T-22N□-H	22	5 / 10	100	12	2000	0.40	500
CLH1608T-27N□-H	27	5 / 10	100	12	1900	0.45	500
CLH1608T-33N□-H	33	5 / 10	100	12	1600	0.55	400
CLH1608T-39N□-H	39	5 / 10	100	12	1400	0.60	400
CLH1608T-47N□-H	47	5 / 10	100	12	1300	0.70	400
CLH1608T-56N□-H	56	5 / 10	100	12	1100	0.75	400
CLH1608T-62N□-H	62	5 / 10	100	12	1050	0.85	400
CLH1608T-68N□-H	68	5 / 10	100	12	1050	0.85	400
CLH1608T-82N□-H	82	5 / 10	100	12	900	1.00	300
CLH1608T-R10□-H	100	5 / 10	100	12	770	1.20	300
CLH1608T-R12□-H	120	5 / 10	50	8	650	1.30	300
CLH1608T-R15□-H	150	5 / 10	50	8	550	1.70	250
CLH1608T-R18□-H	180	5 / 10	50	8	520	1.90	250
CLH1608T-R22□-H	220	5 / 10	50	8	500	2.00	250
CLH1608T-R27□-H	270	5 / 10	50	8	470	2.20	150
CLH1608T-R33□-H	330	5 / 10	50	8	320	2.80	100
CLH1608T-R39□-H	390	5 / 10	50	8	300	3.00	100

**Note:** When ordering, please specify tolerance code. Tolerance : S=±0.3nH , J=±5% , K=±10%

- Operating temperature range - 55°C ~ 125°C(Including self - temperature rise)
- IDC : Applied the current to coils, the inductance shall be less than 10% initial value
- Measure Equipment :  
 L & Q : Agilent E4991A+Agilent 16197A  
 SRF : HP8753D  
 RDC : HP4338B or CHEN HWA 502

## Test Instruments : Agilent E4991A Material/Impedance Analyzer

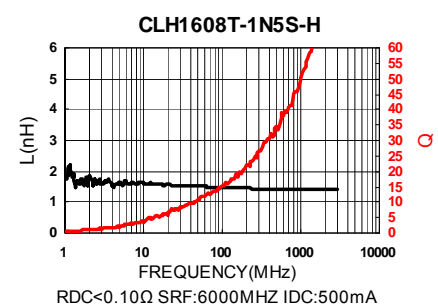
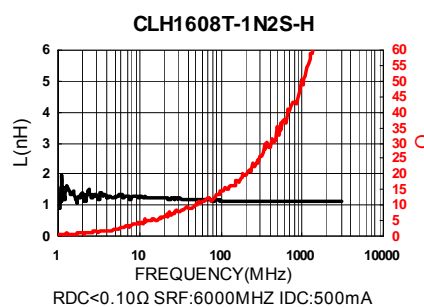
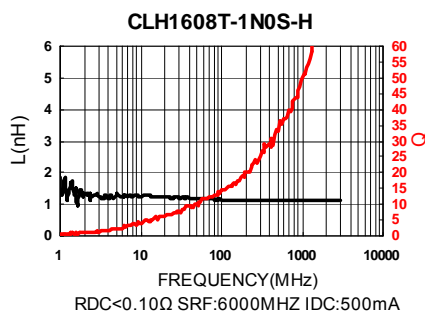

## Test Instruments : Agilent E4991A Material/Impedance Analyzer

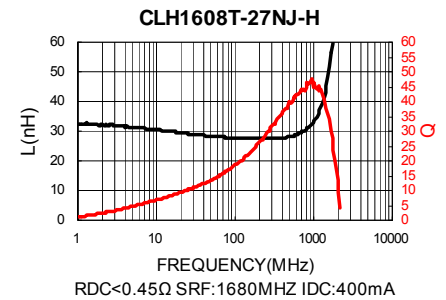
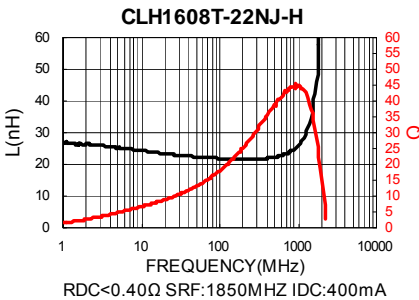
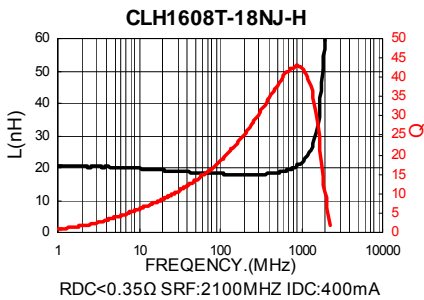
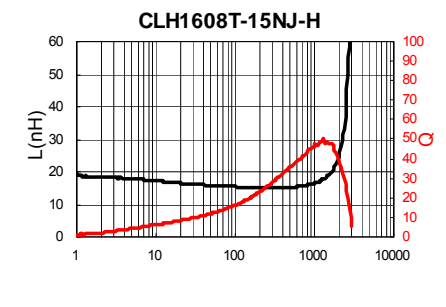
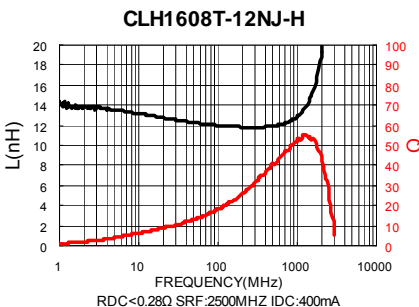
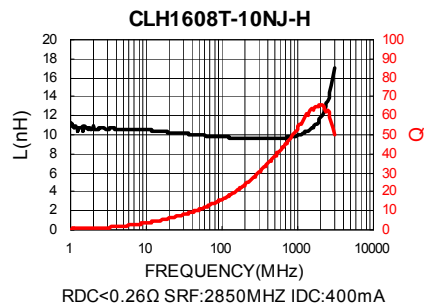
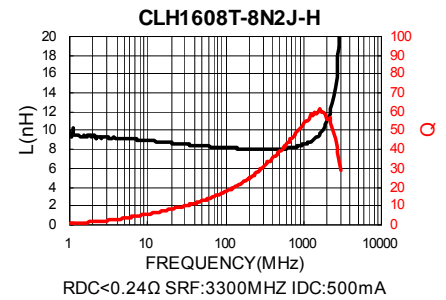
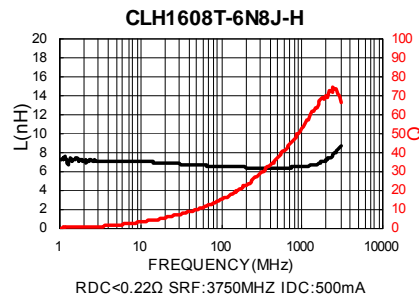
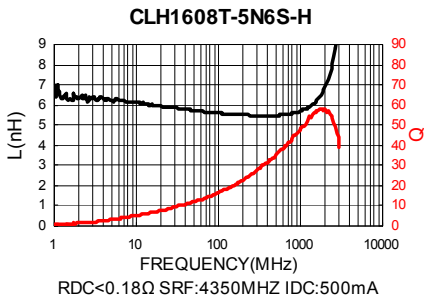
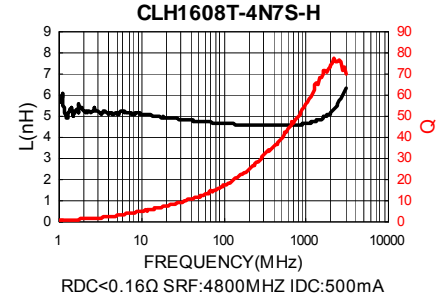
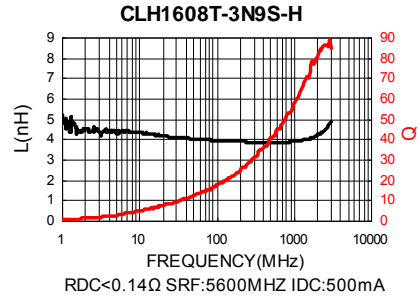
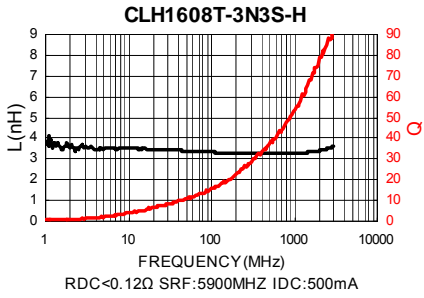
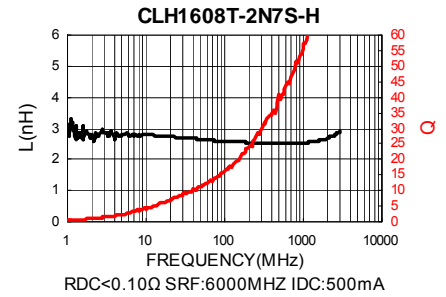
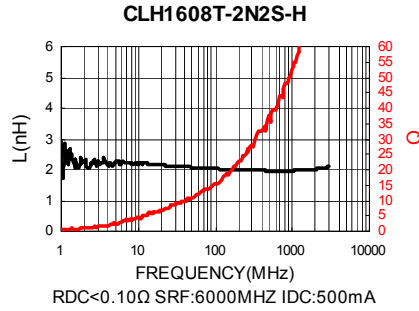
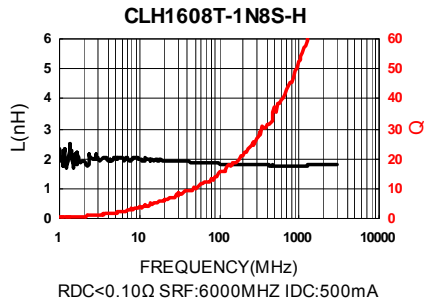

Test Instruments : Agilent E4991A Material/Impedance Analyzer

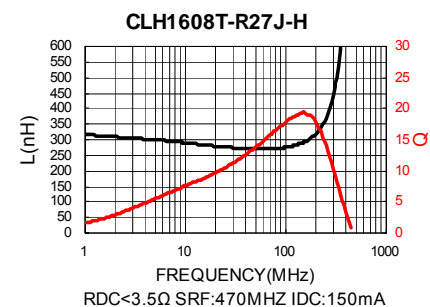
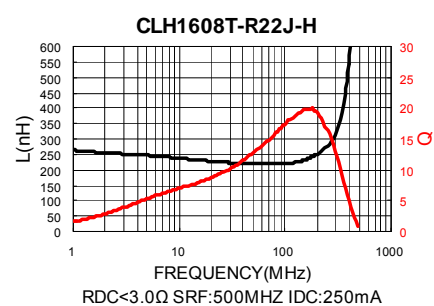
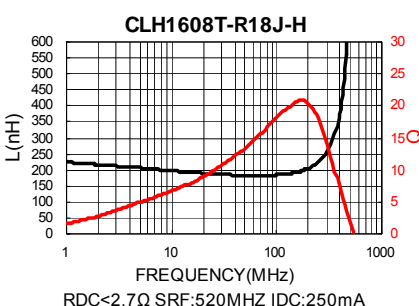
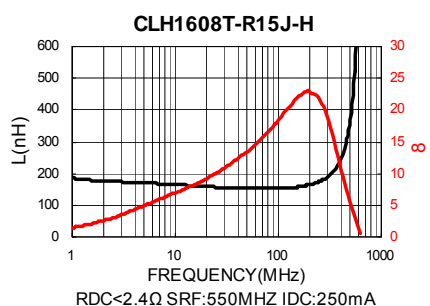
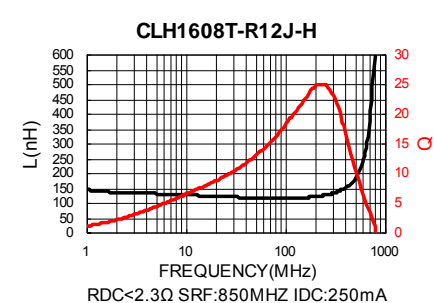
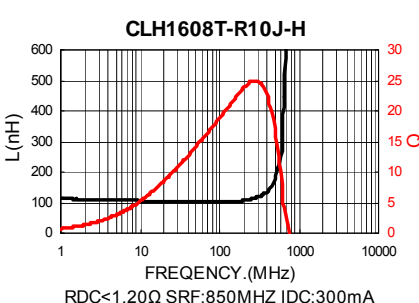
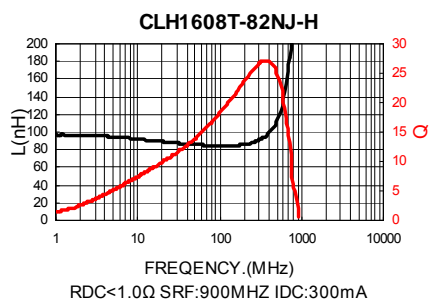
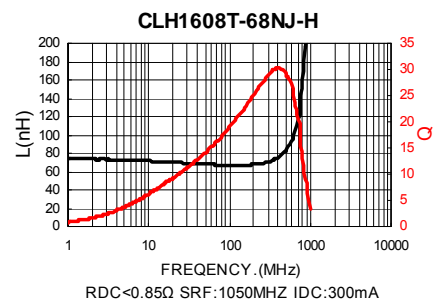
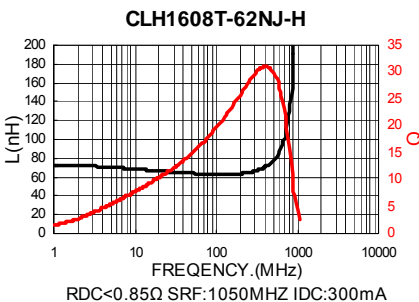
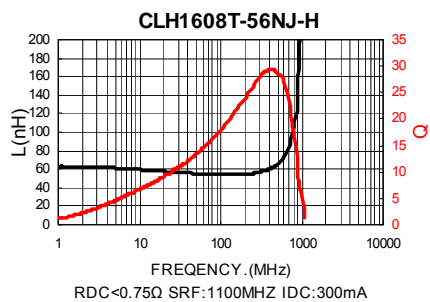
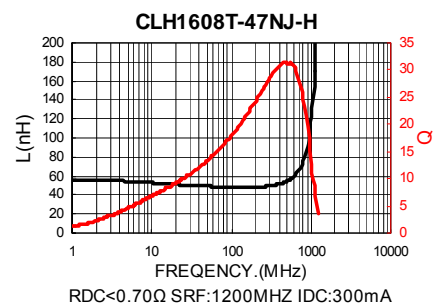
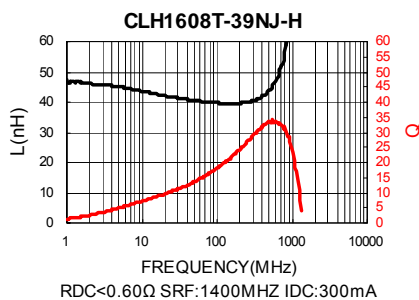
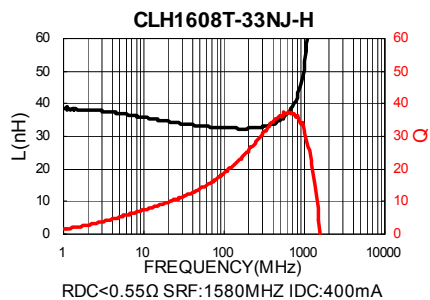

## Electrical Characteristics

Part Number	Inductance (nH)	Tolerance (±%)	Test Frequency (MHz)	Q Min	SRF (MHz) Typ.	RDC (Ω) Max	IDC (mA) Max
CLH2012T-1N0□-S	1.0	±0.3nH	100	10	> 6000	0.10	300
CLH2012T-1N2□-S	1.2	±0.3nH	100	10	> 6000	0.10	300
CLH2012T-1N5□-S	1.5	±0.3nH	100	10	> 6000	0.10	300
CLH2012T-1N8□-S	1.8	±0.3nH	100	10	> 6000	0.10	300
CLH2012T-2N2□-S	2.2	±0.3nH	100	10	> 6000	0.10	300
CLH2012T-2N7□-S	2.7	±0.3nH	100	12	> 6000	0.10	300
CLH2012T-3N3□-S	3.3	±0.3nH/10	100	12	> 6000	0.13	300
CLH2012T-3N9□-S	3.9	±0.3nH/10	100	12	5400	0.15	300
CLH2012T-4N7□-S	4.7	±0.3nH/10	100	12	4500	0.20	300
CLH2012T-5N6□-S	5.6	±0.3nH/10	100	12	4000	0.23	300
CLH2012T-6N8□-S	6.8	5 / 10	100	15	3650	0.25	300
CLH2012T-8N2□-S	8.2	5 / 10	100	15	3000	0.28	300
CLH2012T-10N□-S	10	5 / 10	100	15	2500	0.30	300
CLH2012T-12N□-S	12	5 / 10	100	15	2450	0.35	300
CLH2012T-15N□-S	15	5 / 10	100	15	2000	0.40	300
CLH2012T-18N□-S	18	5 / 10	100	15	1750	0.45	300
CLH2012T-22N□-S	22	5 / 10	100	15	1700	0.50	300
CLH2012T-27N□-S	27	5 / 10	100	15	1550	0.55	300
CLH2012T-33N□-S	33	5 / 10	100	15	1350	0.60	300
CLH2012T-39N□-S	39	5 / 10	100	18	1300	0.65	300
CLH2012T-47N□-S	47	5 / 10	100	18	1200	0.70	300
CLH2012T-56N□-S	56	5 / 10	100	18	1150	0.75	300
CLH2012T-68N□-S	68	5 / 10	100	18	1000	0.80	300
CLH2012T-82N□-S	82	5 / 10	100	18	850	0.90	300
CLH2012T-R10□-S	100	5 / 10	100	18	730	1.00	300
CLH2012T-R12□-S	120	5 / 10	50	13	650	1.20	300
CLH2012T-R15□-S	150	5 / 10	50	13	550	1.40	300
CLH2012T-R18□-S	180	5 / 10	50	13	500	1.80	300
CLH2012T-R22□-S	220	5 / 10	50	12	450	2.00	300
CLH2012T-R27□-S	270	5 / 10	50	12	400	2.50	200
CLH2012T-R33□-S	330	5 / 10	50	12	380	3.00	200
CLH2012T-R39□-S	390	5 / 10	50	10	330	3.50	200
CLH2012T-R47□-S	470	5 / 10	50	10	300	4.00	200

**Note:** When ordering, please specify tolerance code. Tolerance : S=±0.3nH , J=±5% , K=±10%

- Operating temperature range - 55°C ~ 125°C(Including self - temperature rise)
- IDC : Applied the current to coils, the inductance shall be less than 10% initial value
- Measure Equipment :  
 L & Q : Agilent E4991A+Agilent 16197A  
 SRF : HP8753D  
 RDC : HP4338B or CHEN HWA 502

### Test Instruments : Agilent E4991A Material/Impedance Analyzer

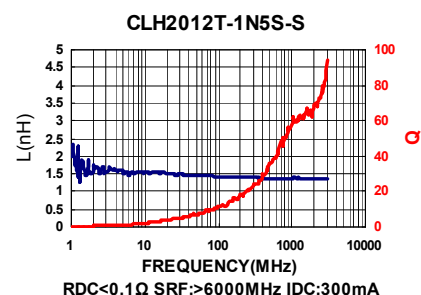
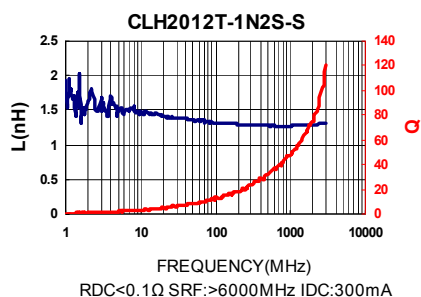
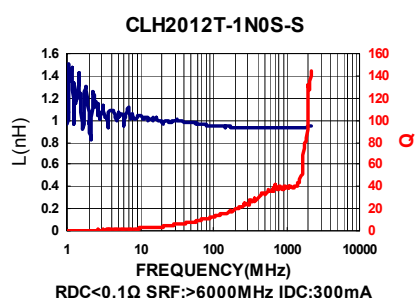

Test Instruments : Agilent E4991A Material/Impedance Analyzer

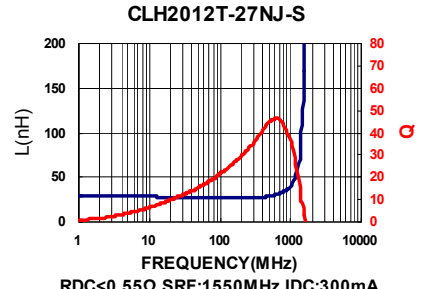
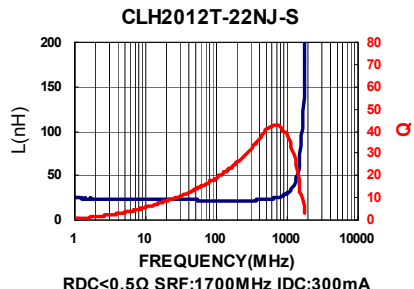
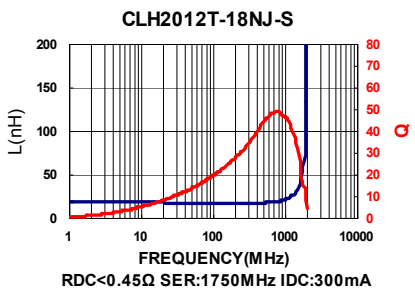
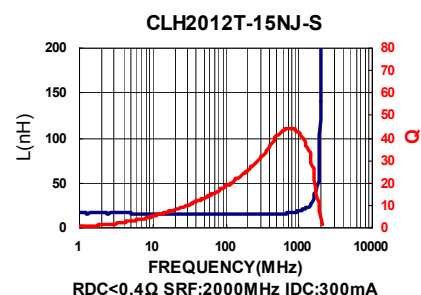
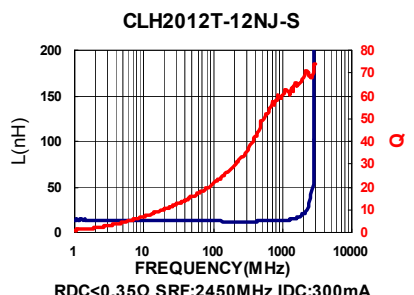
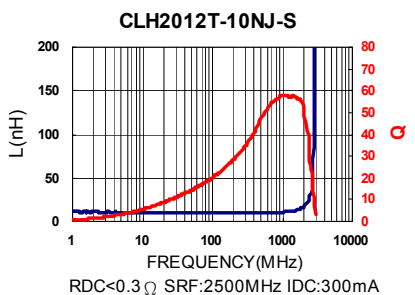
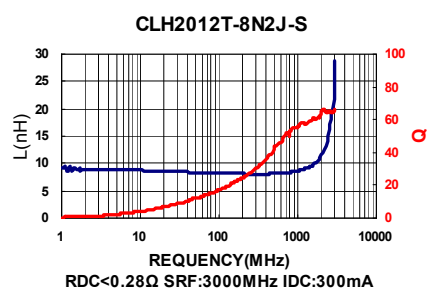
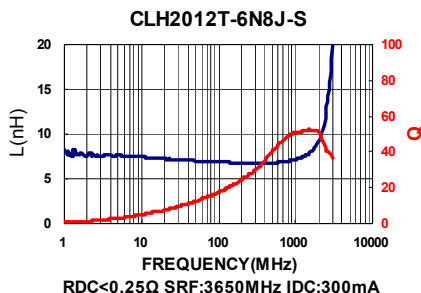
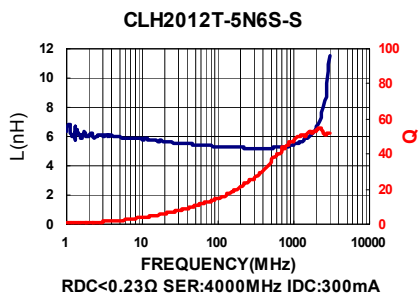
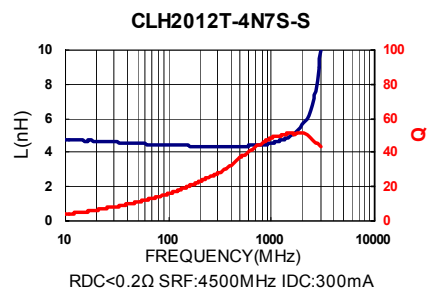
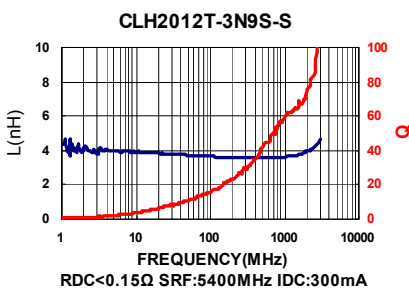
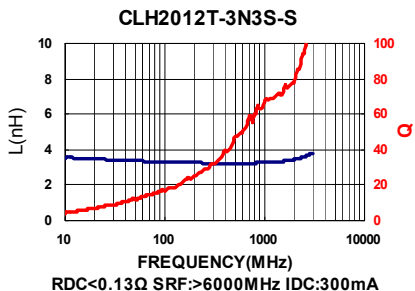
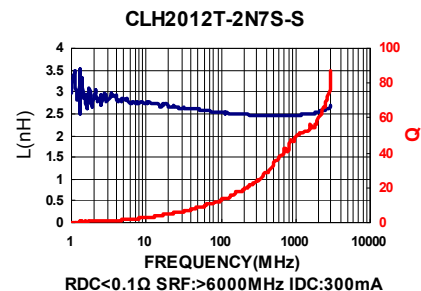
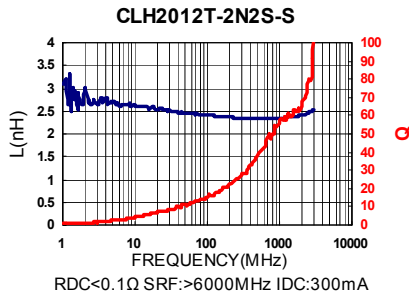
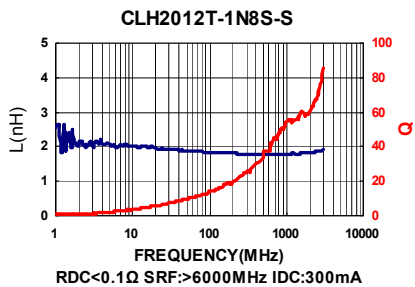

Test Instruments : Agilent E4991A Material/Impedance Analyzer

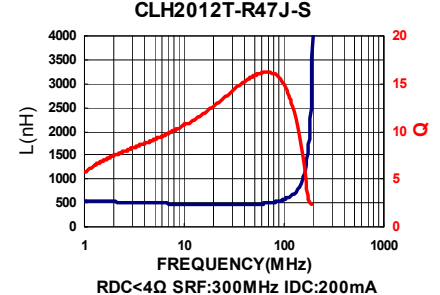
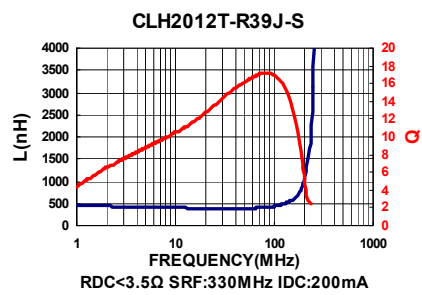
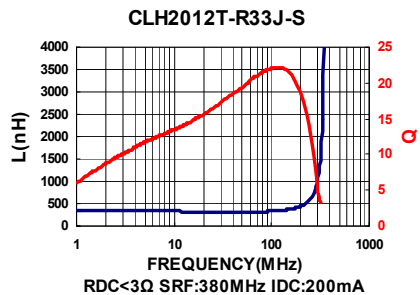
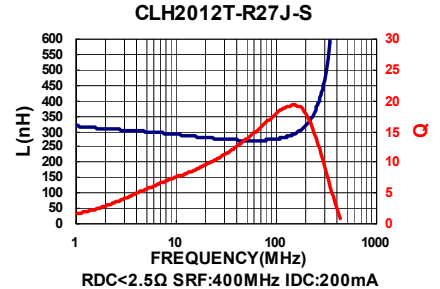
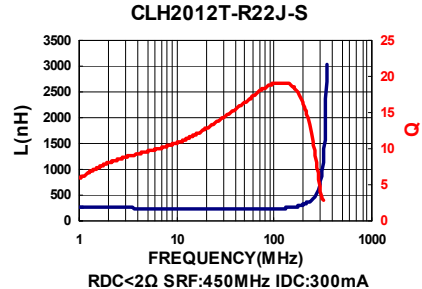
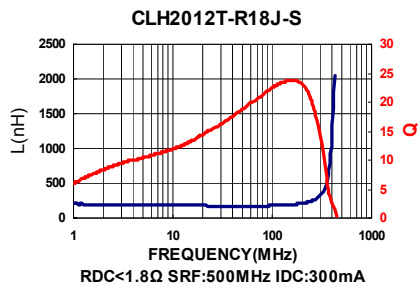
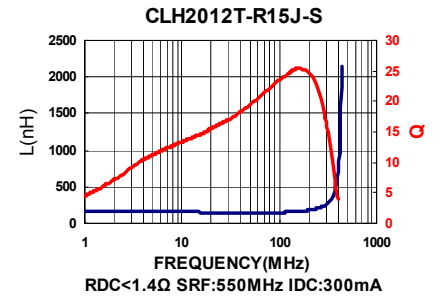
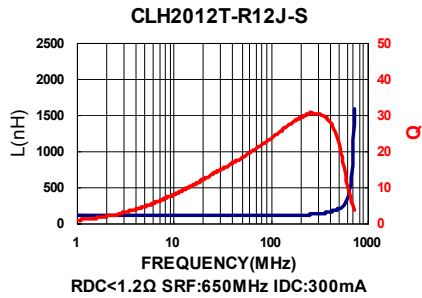
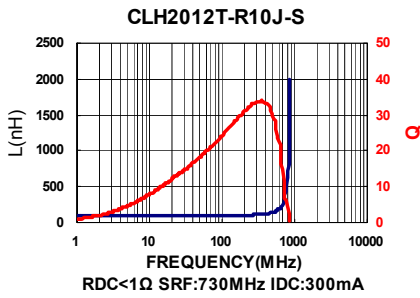
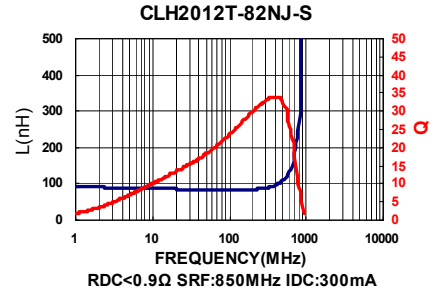
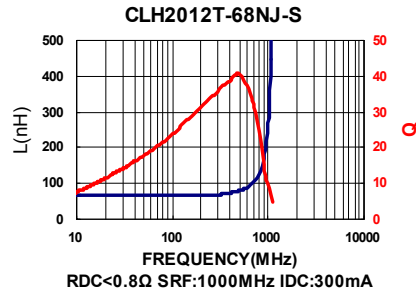
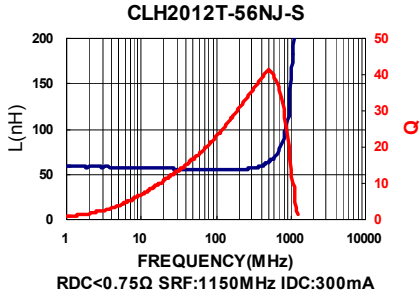
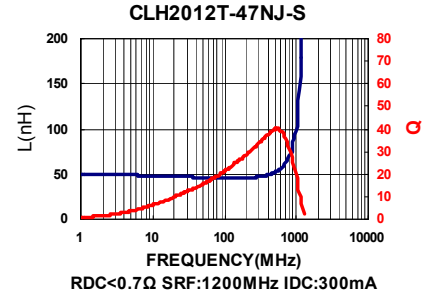
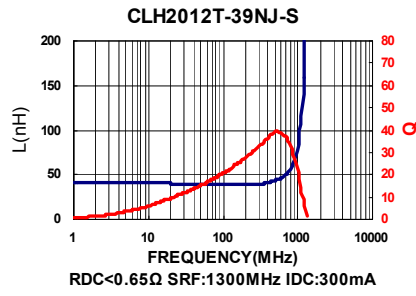
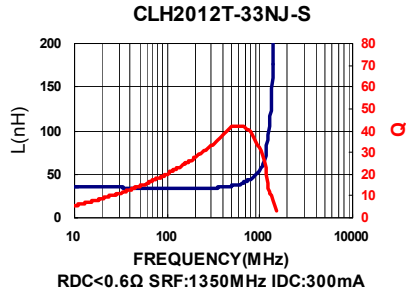



## Packaging Specifications

### Tape Dimensions

Figure A

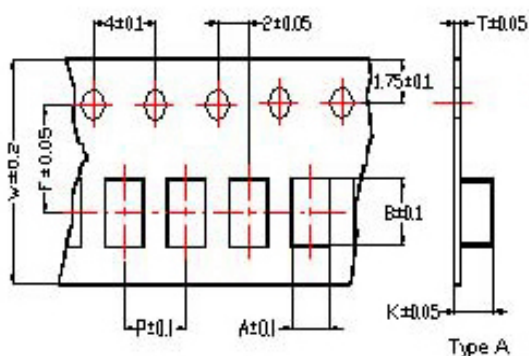
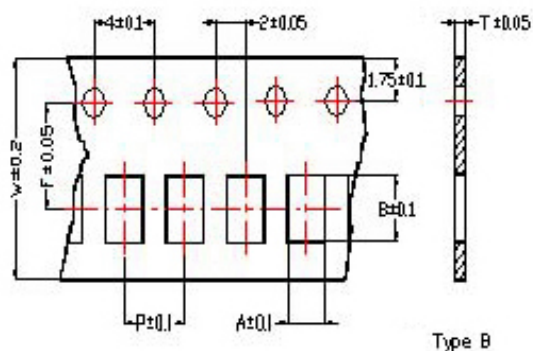
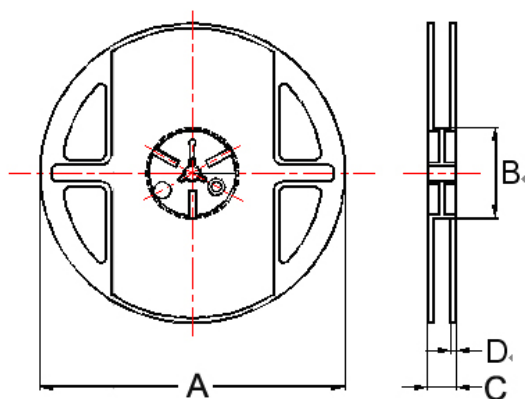

Figure B



### Reel Dimensions



Dimensions in mm

TYPE	Tape Dimensions								Tape Material	Reel Dimensions				Quantity PCS / Reel	
	A	B	T	W	P	F	K	A		B	C	D			
CLH0603	0.37	0.67	0.42	8	2	3.5			B	B	180	60	13	1.5	15000
CLH1005	0.65	1.12	0.60	8	2	3.5			B	A	178	60	12	1.5	10000
CLH1608	1.00	1.80	0.95	8	4	3.5			B	A	178	60	12	1.5	4000
CLH201209	1.58	2.42	0.95	8	4	3.5	1.04		A,B	A	178	60	12	1.5	4000
CLH201212	1.35	2.25	0.22	8	4	3.5	1.35		A	A	178	60	12	1.5	3000

### Tape Material

Figure A

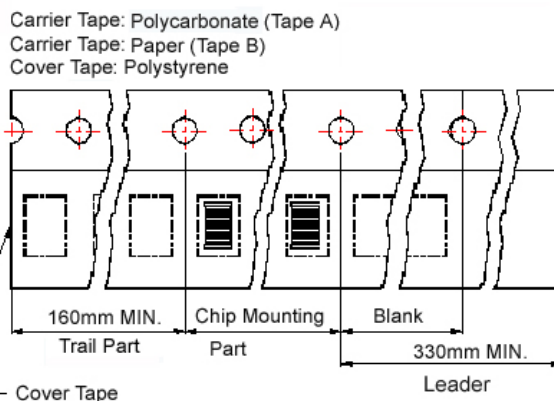
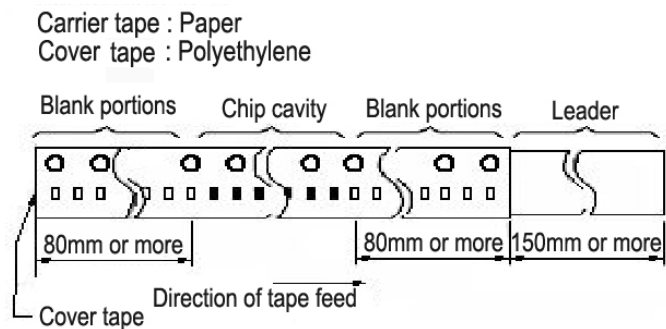

Figure B





## Packaging Specifications

### Tape Dimensions

Figure A

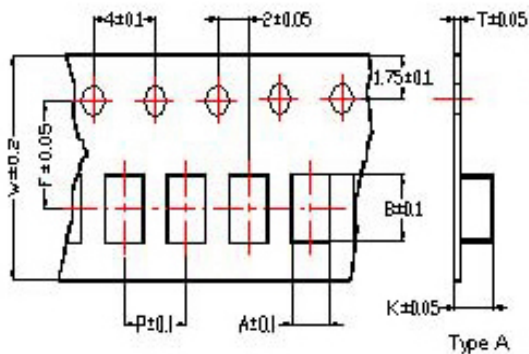

### Tape Material

Figure A

Carrier Tape: Polycarbonate (Tape A)  
Carrier Tape: Paper (Tape B)  
Cover Tape: Polystyrene

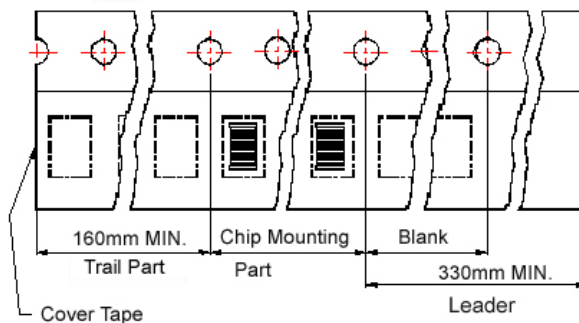

Figure B

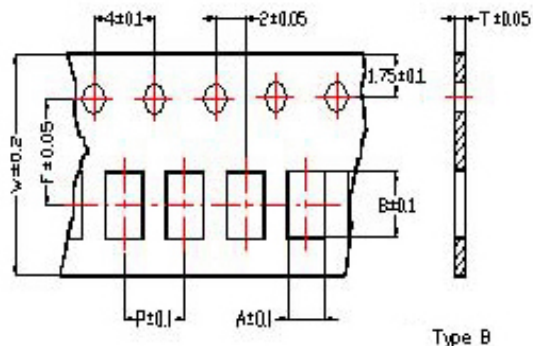
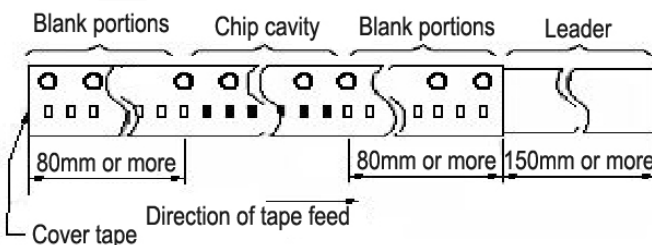
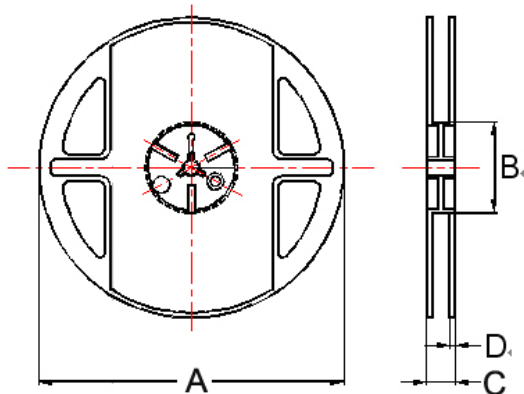

Figure B

Carrier tape : Paper  
Cover tape : Polyethylene



### Reel Dimensions



Dimensions in mm

TYPE	Tape Dimensions							Tape Material	Reel Dimensions				Quantity PCS / Reel	
	A	B	T	W	P	F	K		A	B	C	D		
CLH0603	0.37	0.67	0.42	8	2	3.5		B	B	180	60	13	1.5	15000
CLH1005	0.65	1.12	0.60	8	2	3.5		B	A	178	60	12	1.5	10000
CLH1608	1.00	1.80	0.95	8	4	3.5		B	A	178	60	12	1.5	4000
CLH201209	1.58	2.42	0.95	8	4	3.5	1.04	A,B	A	178	60	12	1.5	4000
CLH201212	1.35	2.25	0.22	8	4	3.5	1.35	A	A	178	60	12	1.5	3000