

# Inductive proximity sensors

## OsiSense XS

Catalog



# Inductive proximity sensors

## OsiSense XS

---

<b>Selection guide</b> .....	<b>page 2</b>
■ General .....	page 12
■ Flush mountability using teach mode:	
Simplicity through innovation .....	page 22

### OsiSense XS, general purpose

■ Cylindrical type	
□ Standard range, flush mountable .....	page 24
□ Increased range, flush mountable .....	page 34
□ Increased range, non flush mountable .....	page 42
■ Block type	
□ Standard range, flush mountable .....	page 46
□ Increased range, flush or non flush mountable using teach mode .....	page 80
■ Cubic type	
□ Standard range, non flush mountable .....	page 50
□ Increased range, flush or non flush mountable .....	page 50
■ Multivoltage sensors with short-circuit protection .....	page 60
■ Sensors with 2 complementary outputs	
□ Solid-state PNP or NPN, NO + NC outputs .....	page 62
□ Solid-state PNP + NPN, NO or NC programmable outputs .....	page 64
■ Plastic case sensors .....	page 66
(for chemical processing, marine applications)	
■ Basic sensors, flush and non flush mountable .....	pages 34 and 35, 68 and 70
■ Quasi flush mountable sensors, increased range .....	page 74
■ Miniature sensors .....	page 76

### OsiSense XS Application

■ Adjustable range sensors .....	page 78
■ Sensors for rotation monitoring .....	page 83
■ Sensors with analogue output .....	page 87
■ Sensors for food/beverage and pharmaceutical applications	
□ Cubic, plastic .....	page 94
□ Cylindrical, stainless steel .....	pages 96 to 101
□ Cylindrical, plastic .....	pages 102 to 105
□ Cylindrical, stainless steel, for harsh industrial environments .....	pages 106
■ Sensors for assembly, packaging, conveying or light handling applications	
□ 12 x 26 x 40 mm format .....	page 108
□ 80 x 80 x 40 mm format .....	page 112
■ Sensors for welding machine applications .....	pages 114 to 119
■ Fixed sensing distance detection for ferrous and non ferrous materials .....	pages 120 to 125
■ Selective detection of ferrous and non ferrous materials .....	page 126

---

## OsiSense XS

- Accessories . . . . . *page 128*
- Detection curves . . . . . *page 132*
- Substitution table . . . . . *page 136*

## Technical information

- Protective treatment of equipment according  
to climatic environment . . . . . *page 142*
- Product standards and certifications . . . . . *page 144*
- Degrees of protection provided by enclosures . . . . . *page 146*
- **Product reference index** . . . . . *page 148*

# Inductive proximity sensors

OsiSense XS  
General purpose

## Cylindrical type

### Standard range



Sensing distance Sn (mm)		1.5	2	5	10	
Diameter		Ø 6.5 plain and M8	M12	M18	M30	
Short case	Supply	Page 24				
	3-wire --- (PNP/NPN)	Page 28				
	2-wire ---					
Long case	Supply	Page 25				
	3-wire --- (PNP/NPN)	Page 29				
	2-wire ---	-				
	2-wire ~	Page 32				
Function	NO	•	•	•	•	
	NC	•	•	•	•	
Connection	Pre-cabled (L = 2 m) (1)	•	•	•	•	
	M8 connector, 3-pin (3-wire ---)	•	-	-	-	
	M12 connector	•	•	•	•	
	1/2"-20UNF connector	•	•	•	•	
	Remote connector	-	•	•	•	
Degree of protection		IP 65 and IP 67, IP 68 for pre-cabled version, IP 69K for diameters 12 to 30				
Special temperatures	-40 °C, +70 °C	Add the suffix TF to the end of the reference (2)				
	-25 °C, +85 °C	Add the suffix TT to the end of the reference (2)				
Type reference		<b>XS506</b>	<b>XS508</b>	<b>XS512</b>	<b>XS518</b>	<b>XS530</b>
Pages		24 to 33				

(1) Also available in lengths of 5 and 10 m, depending on model  
(2) Product availability depending on model: please consult our Customer Care Centre.

### Increased range



Sensing distance Sn (mm)		2.5	4	8	15	7	12	22	
Diameter		Ø 6.5 plain and M8	M12	M18	M30	M12	M18	M30	
Short case		Pages 34 and 35					-		
Long case		Page 38					-		
Function		Page 36					Page 42		
Connection		Page 38					-		
Degree of protection		-					Page 44		
Special temperatures		-					-		
Type reference		<b>XS106</b>	<b>XS108</b>	<b>XS112, XS612</b>	<b>XS118, XS618</b>	<b>XS130, XS630</b>	<b>XS612</b>	<b>XS618</b>	<b>XS630</b>
Pages		34 to 41					42 to 45		

(1) Also available in lengths of 5 and 10 m, depending on model  
(2) Product availability depending on model: please consult our Customer Care Centre.



# Inductive proximity sensors

OsiSense XS  
General purpose

## Block type

### Standard range

Flush mountable



Sensing distance Sn (mm)	2.5	5	10	15	40
Dimensions (W x H x D)	8 x 22 x 8	15 x 32 x 8	26 x 26 x 13	40 x 40 x 15	80 x 80 x 26
Supply	Page 46	Page 46	Page 48	Page 48	Page 48
3-wire --- (PNP/NPN)	Page 46	Page 46	Page 48	Page 48	Page 48
2-wire ---	-	-	-	-	-
~	-	-	-	-	-
~	-	-	-	-	-
Function	•	•	•	•	•
NO	•	•	•	•	•
NC	-	-	-	-	-
NO + NC	-	-	-	-	-
NO/NC	-	-	-	-	-
Connection	•	•	•	•	•
Pre-cabled (L = 2 m) (1)	-	-	•	•	-
M8 connector, 3-pin (3-wire ---)	-	-	-	-	•
M12 connector	-	-	-	-	-
1/2"-20UNF connector	-	-	-	-	-
Screw terminals	-	-	-	-	-
Remote connector	•	•	-	-	-
M8	-	-	•	•	-
M12	-	-	-	-	-
1/2"-20 UNF	-	-	-	-	-
Other remote connectors available	M18, screw terminal, 7/8", DIN: please consult our Customer Care Centre				
Degree of protection	IP 67 IP 67, double insulation ☐ or IP 68, double insulation ☐, depending on model				
Special temperatures	- 40 °C, + 70 °C Add the suffix TF to the end of the reference (2)				
	- 25 °C, + 85 °C Add the suffix TT to the end of the reference (2)				
Type reference	<b>XS7J</b>	<b>XS7F</b>	<b>XS7E</b>	<b>XS7C</b>	<b>XS7D</b>
Pages	46		48		

(1) Also available in lengths of 5 and 10 m, depending on model.  
(2) Product availability depending on model: please consult our Customer Care Centre.

### Standard and increased ranges



Flush mountable Non flush mountable







15	20	40
40 x 40 x 70 and 40 x 40 x 117		
Pages 50, 52 and 54		
Pages 50, 52 and 54		
Page 56		
Pages 50, 52 and 56		
•	•	•
•	•	•
-	•	•
•	•	•
-	-	-
-	-	-
•	•	•
•	•	•
•	•	•
-	-	-
-	-	-
-	-	-
-	-	-
-	-	-
IP 65, IP 67 and IP 69K		
Add the suffix TF to the end of the reference (2)		
Add the suffix TT to the end of the reference (2)		
<b>XS7C2, XS7C4, XS8C2, XS8C4, XS7C40, XS8C40, XS7T4 and XS8T4</b>		
50, 52, 54 and 58		

# Inductive proximity sensors

OsiSense XS  
General purpose

Sensor type: flush and non flush mountable		Multivoltage sensors	Sensors with 2 complementary outputs	
		With short-circuit protection	Solid-state PNP or NPN NO + NC outputs	Solid-state PNP + NPN, NO or NC programmable outputs
				
<b>Sensing distance Sn (mm)</b>	Flush mountable Non flush mountable	2 ... 10 4 ... 15	1.5 ... 10 2.5 ... 15	2 ... 10 4 ... 15
<b>Diameter</b>		Threaded: M12, M18, M30	Plain: Ø 6.5 Threaded: M8, M12, M18, M30	Threaded: M12, M18, M30
<b>Case material</b>		Nickel plated brass	Nickel plated brass or stainless steel or plastic	Nickel plated brass or plastic
<b>Supply</b>		—	•	•
		—	—	—
		•	—	—
<b>Function</b>		•	—	—
	NO	•	—	—
	NC	•	—	—
	NO + NC	—	•	—
	NO/NC	—	—	• programmable
<b>Connection</b>		•	•	•
	Pre-cabled (L = 2 m) (1)	—	—	—
	M8 connector, 3-pin (3-wire ---)	—	—	—
	M12 connector	—	•	•
	1/2"-20UNF connector	•	—	—
	Remote connector	—	—	—
		Remote connectors available: M8, M12, M18, screw terminal, 7/8", DIN: please consult our Customer Care Centre		
<b>Degree of protection</b>		IP 67 or IP 68 depending on model		
<b>Special temperatures</b>		Add the suffix TF to the end of the reference (2) Add the suffix TT to the end of the reference (2)		
<b>Type reference</b>		XS1M XS2M	XS1●●●C410 XS2●●●C410	XS1M●●KP340 XS2M●●KP340 XS4P●●KP340
<b>Pages</b>		60	62	64

(1) Also available in lengths of 5 and 10 m, depending on model.  
(2) Product availability depending on model: please consult our Customer Care Centre.  
(3) Packed and sold in lots of 20

Plastic case sensors	Basic sensors	Almost flush mountable sensors	Miniature sensors
For chemical processing, marine applications	For repetitive machines		For robotic, transfer machine, assembly line applications
			
— 2.5 ... 15	1.5 ... 10 2.5 ... 15	2.5 ... 15 — 2.5 ... 20	— 1
Threaded: M8, M12, M18, M30	Plain: Ø 6.5 Threaded: M8, M12, M18, M30	Plain: Ø 6.5 Threaded: M8, M12, M18, M30	Plain: Ø 4 Threaded: M5
Plastic	Nickel plated brass or plastic	Nickel plated brass	Nickel plated brass or stainless steel
•	•	•	•
—	—	—	—
•	—	—	—
—	•	•	•
•	•	•	•
—	—	—	—
—	—	—	—
•	•	•	•
—	•	•	•
—	•	•	•
•	—	—	—
	Remote connectors available: M8, M12, M18, screw terminal, 7/8", DIN: please consult our Customer Care Centre		
IP 67 or IP 68 depending on model	IP 67	IP 67 or IP 68	IP 67
	Add the suffix TF to the end of the reference (2) Add the suffix TT to the end of the reference (2)		
XS4P	XS1●●BL● XS2●●AL● XS2●●BL●	XS1●●B3●●●TQ (3)	XS1N●●349
66	68 and 70	34 and 35	74
			XS1L XS2L XS1N
			76

# Inductive proximity sensors

## OsiSense XS

### Applications

### Applications

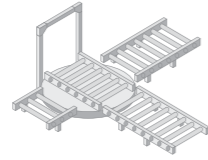

Conveying

Sensor type: flush and non flush mountable

Adjustable range sensors

Developed in accordance with the needs expressed by our customers, these sensors provide a complete solution for specific application functions: rotation monitoring, selective detection, analogue control, etc.



<b>Sensing dist.</b>	Flush mountable	<b>3...11 (1)</b>	<b>15</b>	<b>25</b>	<b>60</b>
<b>Sn (mm)</b>	Non flush mountable	<b>5...18 (1)</b>	–	–	–
<b>Form</b>	<b>Cylindrical</b>	M12 x 54 M18 x 67 M30 x 71	–	–	–
	<b>Block (W x H x D) dimensions in mm</b>	–	26 x 26 x 13	40 x 40 x 15	80 x 80 x 26
<b>Case material</b>		Nickel plated brass	PBT	PBT	PBT
<b>Supply</b>		•	•	•	•
		–	–	–	–
		–	•	•	•
<b>Function</b>		•	•	•	•
	NO	•	•	•	•
	NC	•	•	•	•
	NO + NC	–	–	–	–
	NO/NC	–	–	–	–
<b>Connection</b>		–	•	•	•
	Pre-cabled (L = 2 m) (2)	–	•	•	•
	M8 connector, 3-pin (--- 3-wire)	–	•	•	–
	M12 connector	–	–	–	•
	1/2"-20UNF connector	–	–	–	•
	Remote connector	•	•	•	•
	Screw terminals	–	–	–	–
<b>Degree of protection</b>		IP 67, double insulation ☐	IP 67, double insulation ☐ or IP 68, double insulation ☐, depending on model.		
<b>Special temperatures</b>		Add the suffix TF to the end of the reference (3) Add the suffix TT to the end of the reference (3)			
<b>Type reference</b>		<b>XS612B2</b> <b>XS618 B2</b> <b>XS630 B2</b>	<b>XS8E</b>	<b>XS8C</b>	<b>XS8D</b>
<b>Pages</b>		78	80		

(1) Depending on model.  
(2) Also available in lengths of 5 and 10 m, depending on model.  
(3) Product availability depending on model: please consult our Customer Care Centre.



Detection of underspeed, shaft overload

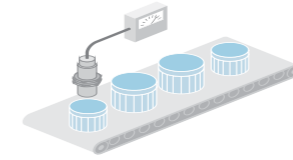

Position, displacement and deformation control/monitoring

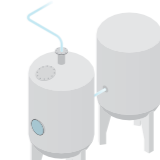

Machine with stainless steel housing

Sensors for rotation monitoring

Sensors with analogue output  
0 ... 10 V or 4 ... 20 mA

Sensors for food/beverage and pharmaceutical applications  
Cylindrical, stainless steel 316 L    Cylindrical, plastic



<b>10</b>	<b>10...15 (1)</b>	<b>0.2...10 (1)</b>	<b>5...40 (1)</b>	–	–	<b>6, 10 or 20 (1)</b>	–	–
<b>10</b>	<b>10...15 (1)</b>	<b>0.4...60 (1)</b>	<b>5...40 (1)</b>	<b>2...25</b>	<b>2...25</b>	<b>10, 20 or 40 (1)</b>	<b>7...22 (1)</b>	<b>7...22 (1)</b>
M30 x 81	–	Threaded: M12, M18, M30	–	–	–	Threaded: M12, M18, M30	Plain: Ø 18 Threaded: M12, M18, M30	Threaded: M12, M18, M30
–	26 x 26 x 13 40 x 40 x 15	–	32 x 15 x 8 26 x 26 x 13 40 x 40 x 15 80 x 80 x 26	40 x 40 x 70	40 x 40 x 117	–	–	–
<b>Metal</b>	<b>PBT</b>	<b>Metal or plastic</b>	<b>PBT</b>	<b>PBT</b>	<b>PBT</b>	<b>Stainless steel, 316 L</b>	<b>Stainless steel, 316 L</b>	<b>Plastic, PPS</b>
•	•	•	•	•	•	•	•	•
–	–	–	–	–	–	–	–	–
•	•	–	–	–	–	–	•	•
–	–	–	–	–	–	•	•	•
•	•	–	–	–	–	–	–	–
–	–	–	–	–	–	–	–	–
–	–	–	–	–	–	–	–	–
•	–	•	•	–	–	–	•	•
–	–	–	–	–	–	–	–	–
–	–	–	•	•	–	•	•	•
–	–	–	–	–	–	–	•	•
–	•	–	–	–	–	–	–	–
–	–	–	–	–	•	–	–	–
IP 67	IP 67, double insulation ☐	IP 67	IP 67 or IP 68 (pre-cabled version)	IP 65, IP 67 IP 69K	IP 65, IP 67 IP 69K	IP 68, IP 69K	IP 68 (pre-cabled version), double insulation ☐ IP 69K conforming to DIN 40050	
Add the suffix TF to the end of the reference (3) Add the suffix TT to the end of the reference (3)								
<b>XSAV</b>	<b>XS9●11R</b>	<b>XS1M●●●AB1</b> <b>XS4P●●AB1</b>	<b>XS9●●●A</b>	<b>XS9C2</b>	<b>XS9C4</b>	<b>XS9●●S●</b>	<b>XS2●●SA</b>	<b>XS2●●AA</b>
83	85	87	91 and 93	94	94	96	98 and 100	102 and 104

# Inductive proximity sensors

OsiSense XS  
Applications

## Applications

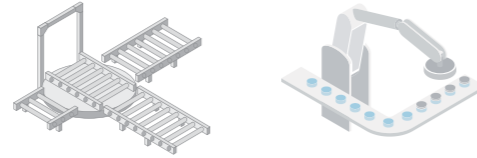

Conveying

Sensor type: flush and non flush mountable

Sensors for conveying and material handling applications

Developed in accordance with the needs expressed by our customers, these sensors provide a complete solution for specific application functions: rotation monitoring, selective detection, analogue control, etc.



<b>Sensing dist.</b>	Flush mountable
<b>Sn (mm)</b>	Non flush mountable
<b>Form</b>	Cylindrical
<b>Block (W x H x D) dimensions in mm</b>	
<b>Case material</b>	
<b>Supply</b>	<ul style="list-style-type: none"> <li>•</li> <li>~</li> <li>λ</li> </ul>
<b>Function</b>	<ul style="list-style-type: none"> <li>NO</li> <li>NC</li> <li>NO + NC</li> <li>NO/NC</li> </ul>
<b>Connection</b>	<ul style="list-style-type: none"> <li>Pre-cabled (L = 2 m) (2)</li> <li>M8 connector, 3-pin (--- 3-wire)</li> <li>M12 connector</li> <li>1/2"-20UNF connector</li> <li>Remote connector</li> <li>Screw terminals</li> </ul>
<b>Degree of protection</b>	
<b>Special temperatures</b>	<ul style="list-style-type: none"> <li>-40 °C, +70 °C</li> <li>-25 °C, +85 °C</li> </ul>
<b>Type reference</b>	
<b>Pages</b>	

<b>3, 6, 10 or 20 (1)</b>	<b>2</b>	<b>50</b>
<b>6, 10, 20 or 40 (1)</b>	<b>4</b>	<b>42</b>
Threaded: M8, M12, M18, M30	-	-
-	12 x 40 x 26	80 x 80 x 40
Stainless steel 303	Plastic	Plastic
•	•	•
-	-	-
-	•	-
•	•	•
-	•	-
-	•	-
-	-	-
-	•	-
-	•	-
-	-	-
-	-	-
-	-	-
-	-	-
IP 67 and IP 69K	IP 67	IP 67, double insulation ☐
Add the suffix TF to the end of the reference (3)		
Add the suffix TT to the end of the reference (3)		
<b>XS9●●R●</b>	<b>XS7G</b> <b>XS8G</b>	<b>XS7D</b>
106	108	112

(1) Depending on model.  
(2) Also available in lengths of 5 and 10 m, depending on model.  
(3) Product availability depending on model: please consult our Customer Care Centre.

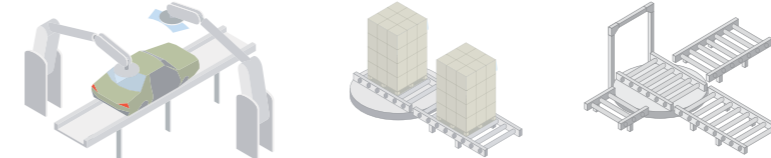

Robotics

Assembly machines, conveyor systems, material handling

Sensors for welding machine applications

Factor 1 (Fe/Nfe) sensors for ferrous and non ferrous materials

Selective detection sensors for ferrous materials only or non ferrous materials only



<b>6 or 10 (1)</b>	<b>5, 10 or 15 (1)</b>	<b>20</b>	<b>20</b>	<b>5, 6 or 10 (1)</b>
-	-	-	-	-
Threaded: M12, M18	Threaded: M18, M30	-	-	Threaded: M18
-	-	40 x 40 x 70	40 x 40 x 117	-
Stainless steel 303	Metal	PBT	PBT	Metal
•	•	•	•	•
-	-	-	-	-
-	-	-	-	-
•	-	-	-	•
-	-	-	-	-
-	-	•	•	-
-	•	-	-	-
-	-	-	-	-
-	•	-	-	-
-	-	-	-	-
-	-	-	•	-
IP 68 and IP 69K	IP 68	IP 65, IP 67 and IP 69K		IP 68
Add the suffix TF to the end of the reference (3)				
Add the suffix TT to the end of the reference (3)				
<b>XS9●●RW, XS●M, XSLC</b>	<b>XS1M●●●KP</b>	<b>XS9C2</b>	<b>XS9C4</b>	<b>XS1M18PA</b>
114, 116 and 118	120	122	122	126

### Standards and certifications

#### Parameters related to the environment

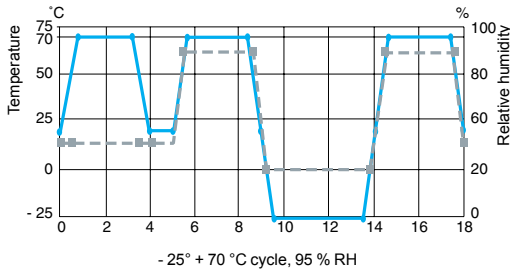

— Temperature °C  
 - - - Humidity as %

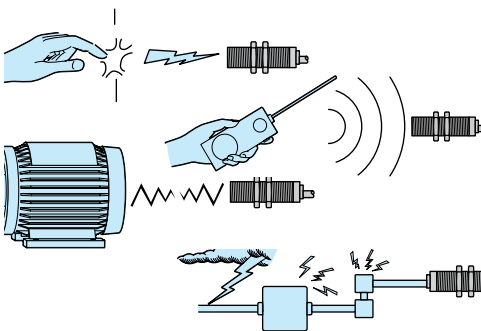

### Recommendations

The sensors detailed in this catalogue are designed for use in standard industrial applications relating to presence detection. These sensors do not incorporate the required redundant electrical circuit enabling their usage in safety applications. For safety applications, please refer to our “Safety solutions using Preventa” catalogue.

### Quality control

**Our inductive proximity sensors are subject to special precautions in order to guarantee their reliability in the most arduous industrial environments.**

- **Qualification**
  - The product characteristics stated in this catalogue are subject to a **qualification procedure** carried out in our laboratories.
  - In particular, the products are subjected to **climatic cycle** tests for 3000 hours whilst powered-up to verify their ability to maintain their characteristics over time.
- **Production**
  - The electrical characteristics and sensing distances at both ambient temperature and extreme temperatures are 100% checked.
  - Products are randomly selected during the course of production and subjected to **monitoring tests** relating to all their qualified characteristics.

### Customer returns

If, in spite of all these precautions, defective products are returned to us, they are subject to **systematic analysis** and **corrective actions** are implemented to eliminate the risks of the fault recurring.

### Conformity to standards

**All Telemecanique Sensors brand inductive proximity sensors conform to and are tested in accordance with the recommendations of standard IEC 60947-5-2.**

### Mechanical shock resistance

The sensors are tested in accordance with standard IEC 60068-2-27, 50 gn, duration 11 ms.

### Vibration resistance

The sensors are tested in accordance with standard IEC 60068-2-6, amplitude  $\pm 2$  mm,  $f = 10 \dots 55$  Hz, 25 gn at 55 Hz.

### Resistance to the environment

- Please refer to the characteristics pages for the various sensors.
- **IP 67:** protection against the effects of immersion. Test conforming to IEC 60529: sensor immersed for 30 minutes in 1 m of water. No deterioration in either operating or insulation characteristics is permitted.
- **IP 68:** protection against prolonged immersion. Sensor immersed for 336 hours in 40 metres of water at 50 °C. No deterioration in either operating or insulation characteristics is permitted. Telemecanique Sensors with an IP 68 degree of protection are ideal for use in the most arduous conditions, such as machine tools, automatic car washers.
- **IP 69K:** protection against the effects of high pressure cleaning. Adherence to standard DIN 40050 which stipulates that the product must withstand a water jet at a pressure of 90 bar and temperature of +80 °C for 3 minutes. No deterioration in either operating or insulation characteristics is permitted.

### Resistance to electromagnetic interference

- Electrostatic discharges
  - ~ and ~ versions: level 4 immunity (15 kV). **IEC 61000-4-2**
- Radiated electromagnetic fields (electromagnetic waves)
  - , ~ and ~ versions: level 2 (3 V/m) or level 3 (10 V/m) immunity. **IEC 61000-4-3**
- Fast transients (motor start/stop interference)
  - version: level 3 immunity (1 kV).
  - ~ and ~ versions: level 4 immunity (2 kV) except  $\varnothing 8$  mm model (level 2). **IEC 61000-4-4**
- Impulse voltage
  - , ~ and ~ versions: level 3 immunity (2.5 kV) except  $\varnothing 8$  mm and smaller models (level 1 kV). **IEC 60947-5-2**

### Resistance to chemicals in the environment

- Owing to the very wide range of chemicals encountered in industry, it is very difficult to give general guidelines common to all sensors.
- To ensure lasting efficient operation, it is essential that any chemicals coming into contact with the sensors will not affect their casing and, in doing so, prevent their reliable operation.
- Cylindrical and flat plastic case sensors offer excellent overall resistance to:
  - chemical products such as salts, aliphatic and aromatic oils, petroleum, acids and diluted bases. For alcohols, ketones and phenols, preliminary tests should be made relating to the nature and concentration of the liquid.
  - food and beverage industry products such as animal or vegetable based products (vegetable oils, animal fat, fruit juice, dairy proteins, etc.).

In all cases, the materials selected (see product characteristics) provide satisfactory compatibility in most industrial environments (for further information, please consult our Customer Information Centre).

### Insulation

### Class 2 devices

Electrical insulation conforming to standards IEC 61140 and NF C 20-030 relating to means of protection against electric shock.



### Principle of inductive detection

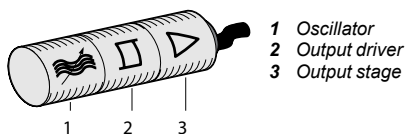

Composition of an inductive proximity sensor

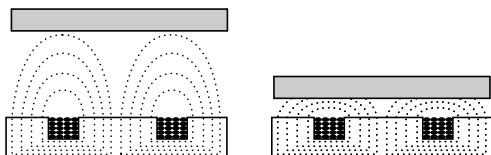

Detection of a metal object

### Operating principle

■ An inductive proximity sensor is solely for the detection of metal objects. It basically comprises an oscillator whose windings constitute the sensing face. An alternating magnetic field is generated in front of these windings.

■ When a metal object is placed within the magnetic field generated by the sensor, the resulting currents induced form an additional load and the oscillations cease. This causes the output driver to operate and, depending on the sensor type, a normally open (NO) or normally closed (NC) output signal is produced.

### Inductive proximity detection

- Inductive proximity sensors enable the detection, without physical contact, of metal objects.
- Their range of applications is very extensive and includes:
  - monitoring the position of machine parts (cams, end stops, etc.),
  - counting the presence of metal objects, etc.

### Advantages of inductive detection

- No physical contact with the object to be detected, thus avoiding wear and enabling detection of fragile objects, freshly painted objects, etc.
- High operating rates. Fast response.
- Excellent resistance to industrial environments (robust products, fully encapsulated in resin).
- Solid-state technology: no moving parts, therefore service life of sensor not related to number of operating cycles.

### Flush mountable using teach mode sensors

- The flush mountable sensors using teach mode are suitable for all metal environments (flush mountable or non flush mountable) since they ensure a maximum sensing distance, even if there is a metal background. Precise detection of the position of the object can be obtained using the teach mode. For further information, see page 22.

### LED indicator

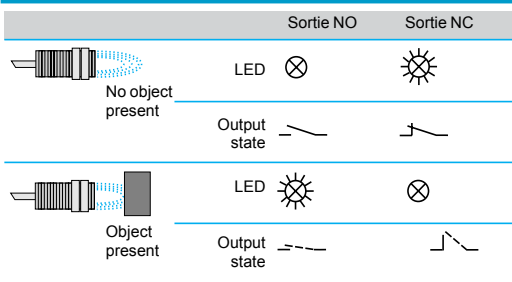

### Output LED

All Telemecanique Sensors inductive proximity sensors incorporate an output state LED indicator.

The flush mountable sensors using teach mode are fitted with a green LED that indicates "Power on" and also assists the user during setting-up (teach mode).

### Mounting sensors on a metal support

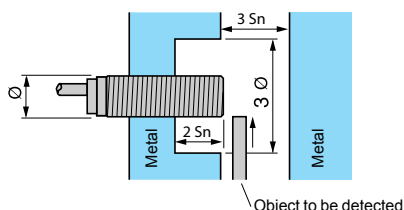
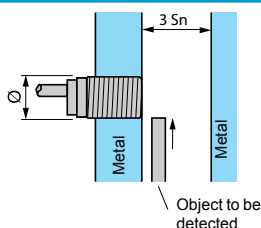

### Flush mountable in metal

- No side clearance required.
- All flush mountable sensors using teach mode also enable detection of an object against a metal background. For further information, see pages 22 and 23.

### Sensors not suitable for flush mounting in metal

- Side clearance required. Sensing distance greater than that for a standard flush mountable model.
- Flush mountable sensors using teach mode eliminate the need for side clearance. For further information, see pages 22 and 23.

### Mounting sensors on a metal support

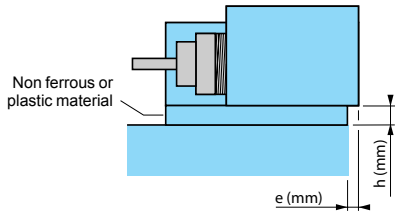

### Mounting distance between sensors

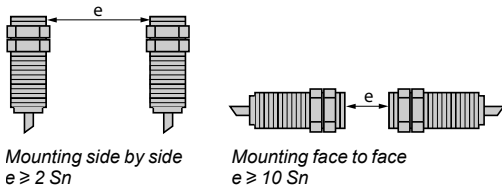

### Mounting using fixing clamp

- Standard flush mountable models:  $e = 0, h = 0$
- Standard non flush mountable models
  - $\varnothing 6.5 / 8 / 12 \text{ mm}$ :  $e = 0, h = 0$
  - $\varnothing 18 \text{ mm}$ : if  $h = 0, e \geq 5; e = 0, h \geq 3$ .
  - $\varnothing 30 \text{ mm}$ : if  $h = 0, e \geq 8; e = 0, h \geq 4$ .
- Flush mountable sensors using teach mode:  $e = 0, h = 0$

### Standard sensors

If 2 standard sensors are mounted too close to each other they are likely to lock in the "detection state" due to interference between their respective oscillating frequencies. To avoid this condition, the minimum mounting distances stated for the sensors should be adhered to or, alternatively, sensors with staggered oscillating frequencies should be used.

### Staggered frequency sensors

For applications where the minimum recommended mounting distances for standard sensors cannot be achieved, it is possible to overcome this restraint by using staggered frequency sensors. Please consult our Customer Care Centre. In this case, a staggered frequency sensor is mounted adjacent to or opposite each standard sensor.

### Tightening torque for cylindrical type sensors

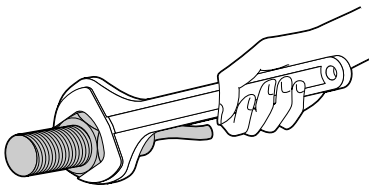

Diameter of sensor (mm)	Maximum tightening torque for the various sensor case materials			
	Brass	Brass	Stainless steel	Plastic
	Short case model	Long case model form A	Long case model form A	All models
	XS5●●B1 XS6●●B3	XS6●●B1 XS6●●B2 XS6●●B4 XSAV●	XS1●● XS2●●	XS4P●●
Ø 5	1.6 N.m	1.6 N.m	2 N.m	–
Ø 8	5 N.m	5 N.m	9 N.m	1 N.m
Ø 12	6 N.m	6 N.m	30 N.m	2 N.m
Ø 18	15 N.m	15 N.m	50 N.m	5 N.m
Ø 30	40 N.m	40 N.m	100 N.m	20 N.m

### Sensing distance

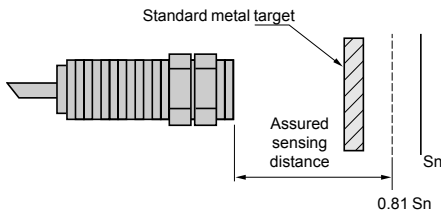
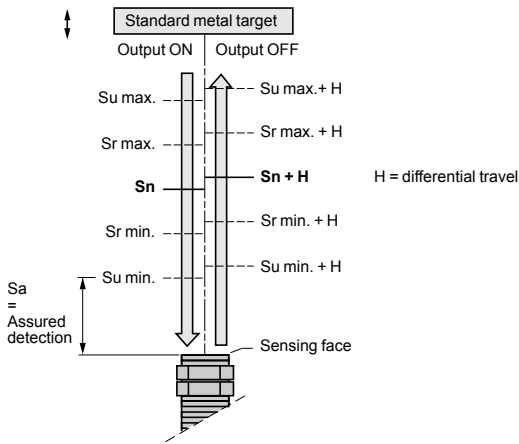

### Terminology

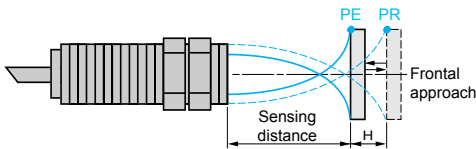

PE = pick-up point, the object is detected  
PR = drop-out point, the object is no longer detected

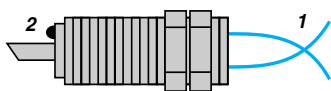
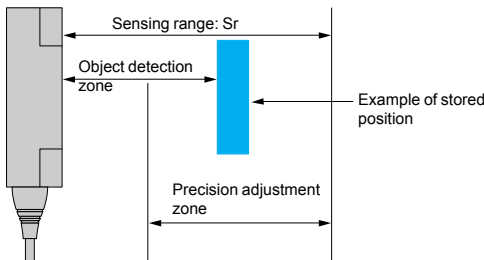

1 Detection threshold curves  
2 "Object detected" LED

### Definitions

In order to ensure that customers can make reliable product comparisons and selection, the standard IEC 60947-5-2 defines various sensing distances, such as:

- Nominal sensing distance (Sn)**  
 The rated operating distance for which the sensor is designed. It does not take into account any variations (manufacturing tolerances, temperature, voltage).
- Effective sensing distance (Sr)**  
 The effective sensing distance is measured at the rated voltage ( $U_n$ ) and the rated ambient temperature ( $T_n$ ). It must be between 90% and 110% of the nominal sensing distance ( $S_n$ ):  
 $0.9 S_n \leq S_r \leq 1.1 S_n$ .
- Usable sensing distance (Su)**  
 The usable sensing distance is measured at the limits of the permissible variations in the ambient temperature ( $T_a$ ) and the supply voltage ( $U_b$ ). It must be between 90% and 110% of the effective sensing distance:  $0.9 S_r \leq S_u \leq 1.1 S_r$ .
- Assured operating distance (Sa)**  
 This is the operating zone of the sensor. The assured sensing distance is between 0 and 81% of the nominal sensing distance ( $S_n$ ):  $0 \leq S_a \leq 0.9 \times 0.9 \times S_n$ .

### Standard metal target

The standard IEC 60947-5-2 defines the standard metal target as a square mild steel (Fe 360) plate, 1 mm thick.

The side dimension of the plate is either equal to the diameter of the circle engraved on the sensing face of the sensor or 3 times the nominal sensing distance ( $S_n$ ).

### Differential travel

The differential travel ( $H$ ), or hysteresis, is the distance between the operating point, as the standard metal target moves towards the sensor, and the release point, as it moves away. This hysteresis is essential for the stable operation of the sensor.

### Repeat accuracy

The repeat accuracy ( $R$ ) is the repeatability of the sensing distance between successive operations. Readings are taken over a period of time whilst the sensor is subjected to voltage and temperature variations: 8 hours, 10 to 30 °C,  $U_n \pm 5\%$ . It is expressed as a percentage of the effective sensing distance  $S_r$ . For all OsiSense XS sensors, the repeat accuracy is 3%.

### Detection zone and precision adjustment zone

- Flush mountable sensors using teach mode, due to adjustment of sensitivity whilst teaching, enable the position of an object to be detected as it approaches from the front or side. The teach mode can be used when the object is located in the zone known as the "precision adjustment zone". When the object approaches from the front, the detection zone of the object ranges from the stored position down to zero.

### Operating zone

- The operating zone relates to the area in front of the sensing face in which the detection of a metal object is certain. The values stated in the characteristics relating to the various types of sensor are for steel objects of a size equal to the sensing face of the sensor. For objects of a different nature (smaller than the sensing face of the sensor, other metals, etc.), it is necessary to apply a correction coefficient.



### Correction coefficients to apply to the assured operating distance

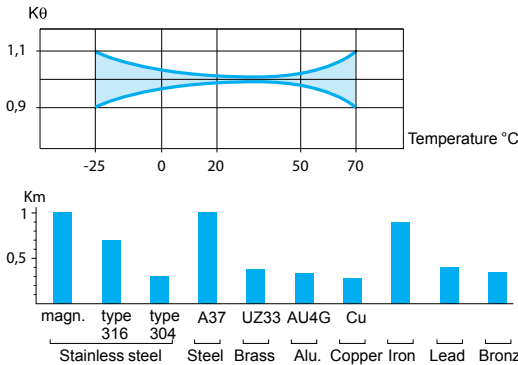

Typical curve for a copper object used with a Ø 18 mm cylindrical sensor

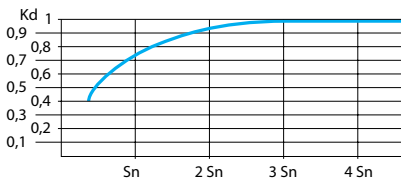

Typical curve for a steel object used with a cylindrical sensor

### Assured operating distance of a sensor

In practice, most objects to be detected are generally made of steel and are of a size equal to, or greater, than the sensing face of the sensor.

For the calculation of the assured operating distance for different operating conditions, one must take into account the correction coefficients that influence it.

The curves indicated are purely representative of typical curves. They are only given as a guide to the approximate usable sensing distance of a proximity sensor for a given application.

### Influence of ambient temperature

Apply a correction coefficient  $K_\theta$ , determined from the curve shown opposite.

### Material of object to be detected

Apply a correction coefficient  $K_m$ , determined from the diagram shown opposite.

The fixed sensing distance models for ferrous/non ferrous (Fe/NFe) materials enable the detection of different objects at a fixed distance, irrespective of the type of material.

Special case of a very thin object made of a non ferrous material.

### Size of object to be detected

Apply a correction coefficient  $K_d$ , determined from the curve shown opposite. When calculating the sensing distance for the selection of a sensor, make the assumption that  $K_d = 1$ .

### Variation of supply voltage

In all cases, apply the correction coefficient  $K_t = 0.9$ .

### Calculation examples

#### Correction of the sensing distance of a sensor

Sensor with nominal sensing distance  $S_n = 15$  mm.  
 Ambient temperature variation 0 to + 20 °C.  
 Object material and size: steel, 30 x 30 x 1 mm thick.  
 The assured sensing distance  $S_a$  is determined using the formula:  
 $S_a = S_n \times K_\theta \times K_m \times K_d \times K_t = 15 \times 0.98 \times 1 \times 0.95 \times 0.9$   
 i.e.  $S_a = 12.5$  mm.

#### Selecting a sensor for a given application

Application characteristics:  
 - object material and size: iron ( $K_m = 0.9$ ), 30 x 30 mm,  
 - temperature: 0 to 20 °C ( $K_\theta = 0.98$ ),  
 - object detection distance: 3 mm ± 1.5 mm, i.e.  $S_a \text{ max.} = 4.5$  mm,  
 - assume  $K_d = 1$ .  
 A sensor must be selected for which  $S_n \geq \frac{S_a}{K_\theta \times K_m \times K_d \times K_t} = \frac{4.5}{0.98 \times 0.9 \times 1 \times 0.9}$   
 i.e.  $S_n \geq 5.7$  mm

### Specific aspects of electronic sensors

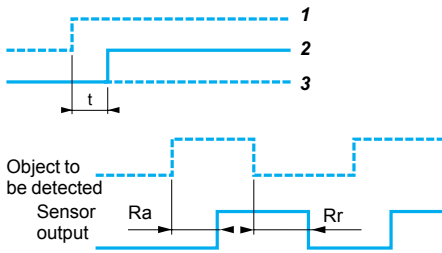
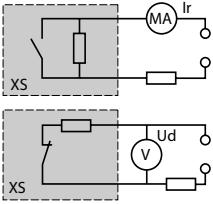

### Supply

### Terminology

- Residual current (Ir)
    - The residual current (Ir) corresponds to the current flowing through the sensor when in the "open" state.
    - Characteristic of 2-wire type proximity sensors.
  - Voltage drop (Ud)
    - The voltage drop (Ud) corresponds to the voltage drop at the sensor's terminals when in the "closed" state (value measured at nominal current rating of sensor).
  - First-up delay
    - The first-up delay corresponds to the time (t) between the connection of the power supply to the sensor and its fully operational state.
- 1 Supply voltage U on  
 2 Sensor operational at state 1  
 3 Sensor at state 0
- Response time
    - Response time (Ra): the time delay between the object to be detected entering the sensor's operating zone and the subsequent change of output state. This parameter limits the speed and size of the object.
    - Recovery time (Rr): the time delay between an object to be detected leaving the sensor's operating zone and the subsequent change of output state. This parameter limits the interval between successive objects.

### Sensors for AC circuits (~ and ~ models)

Check that the voltage limits of the sensor are compatible with the nominal voltage of the AC supply used.

### Sensors for DC circuits

- DC source: check that the voltage limits of the sensor and the acceptable level of ripple are compatible with the supply used.
- AC source (comprising transformer, rectifier, smoothing capacitor): the supply voltage must be within the operating limits specified for the sensor.

Where the voltage is derived from a single-phase AC supply, the voltage must be rectified and smoothed to ensure that:

- the peak voltage of the DC supply is lower than the maximum voltage rating of the sensor.
- the minimum voltage of the supply is greater than the minimum voltage rating of the sensor,

given that :

$$\Delta V = (I \times t) / C$$

$\Delta V$  = max. ripple: 10 % (V),

I = anticipated load current (mA),

t = period of 1 cycle (10 ms full-wave rectified for a 50 Hz supply frequency),

C = capacitance ( $\mu$ F).

As a general rule, use a transformer with a lower secondary voltage (Ue) than the required DC voltage (U).

#### Example:

~ 18 V to obtain  $\approx$  24 V,

~ 36 V to obtain  $\approx$  48 V.

### Outputs

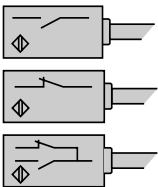

### Output signal (contact logic)

- Normally open (NO)
  - Corresponds to a sensor whose output changes to the closed state when an object is present in the operating zone.
- Normally closed (NC)
  - Corresponds to a sensor whose output changes to the open state when an object is present in the operating zone.
- Complementary outputs (NO + NC)
  - Corresponds to a sensor with a normally closed output and a normally open output.

### Outputs (continued)

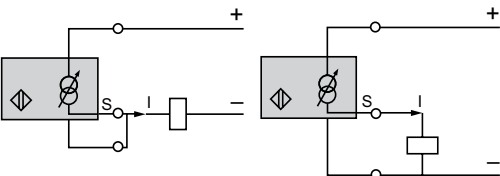
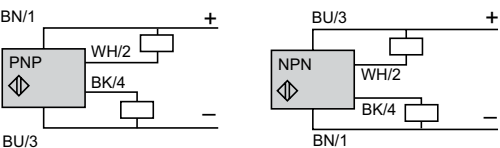
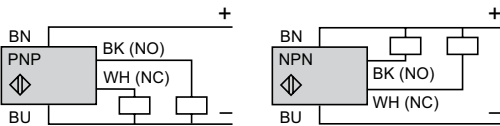
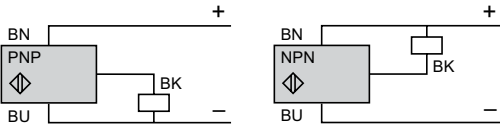
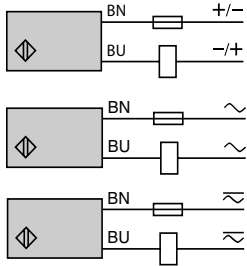

2-wire connection

3-wire connection

### 2-wire type, non polarised NO or NC output

■ **Specific aspects**

These sensors are wired in series with the load to be switched. As a consequence, they are subject to:

- a residual current in the open state (current flowing through the sensor in the "open" state),
- A voltage drop in the closed state (voltage drop across the sensor's terminals in the "closed" state).

■ **Advantages**

- Only 2 leads to be wired: these sensors can be wired in series in the same way as mechanical limit switches,
- They can be connected to either positive (PNP) or negative (NPN) logic PLC inputs,
- No risk of incorrect connections.

■ **Operating precautions**

- Check the possible effects of residual current and voltage drop on the actuator or input connected,
- For sensors that do not have overload and short-circuit protection (AC or AC/DC symbol), it is essential to connect a 0.4 A "quick-blow" fuse in series with the load.

### 3-wire type, NO or NC output, PNP or NPN

■ **Specific aspects**

- These sensors comprise 2 wires for the DC supply and a 3rd wire for the output signal,
- PNP type: switching the positive side to the load,
- NPN type: switching the negative side to the load.

■ **Advantages**

- Protection against supply reverse polarity,
- Protection against overload and short-circuit,
- No residual current, low voltage drop.

### 4-wire type, complementary NO and NC outputs, PNP or NPN

■ **Advantages**

- Protection against supply reverse polarity (+/-).
- Protection against overload and short-circuit.

### 4-wire type, multifunction, programmable NO or NC output, PNP or NPN

■ **Advantages**

- Protection against supply reverse polarity (+/-).
- Protection against overload and short-circuit.

### Specific output signals, analogue type

■ These sensors convert the approach of a metal object towards the sensing face into an output current variation which is proportional to the distance between the object and the sensing face.

■ Two models available:

- 0...10 V (0...10 mA) output for 3-wire connection,
- 4-20 mA output for 2-wire connection.

### Features of the various models

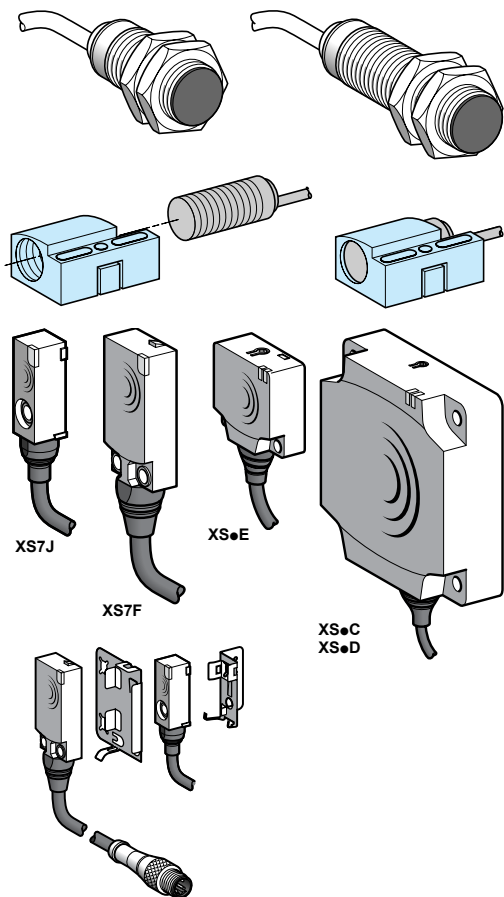

### Types of case

- **Cylindrical case**
  - Fast installation and setting-up.
  - Short case and long case, 2-wire and 3-wire versions available.
  - Pre-cabled (moulded cable) and various integral connector (M8, M12, 7/8", M18) and remote connector (on flying lead) versions available.
  - Small size facilitates mounting in locations with restricted access.
  - **Interchangeability**, provided by indexed **fixing clamp**: when assembled, becomes similar to a block type sensor.

- **Flat case**
  - Reduced size (sensor volume divided by 8).
  - Fast installation by mounting on clip-on brackets.
  - Precision detection with the flush mountable sensors using teach mode (see page 22).

### Electrical connection

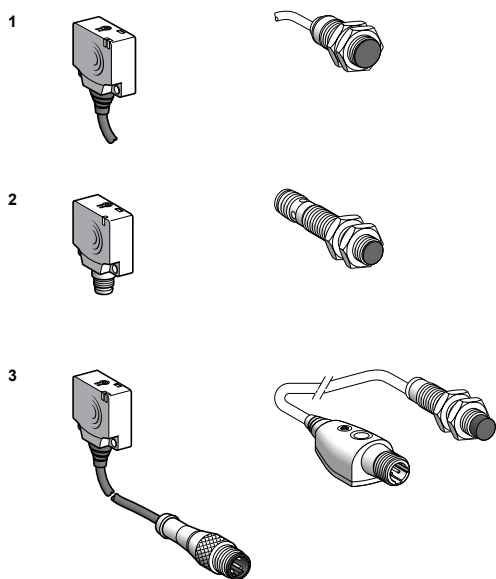

### Connection methods

- 1 Pre-cabled:** factory fitted moulded cable, good protection against splashing liquids (IP 68). Example: machine tool.
- 2 Connector:** easy installation and maintenance (IP 67).
- 3 Remote connector:** easy installation and maintenance (IP 68 at sensor level and IP 67 at remote connector level).

### Wiring advice

- **Length of cable**
  - No limitation up to 200 m or up to a line capacitance of < 100 nF (characteristics of sensor remain unaffected).
  - In this case, it is important to take into account the voltage drop on the line.
- **Separation of control and power circuit wiring**
  - The sensors are immune to electrical interference encountered in normal industrial conditions.
  - Where extreme conditions of electrical "noise" could occur (large motors, spot welders, etc.), it is advisable to protect against transients in the normal way:
    - suppress interference at source,
    - separate power and control wiring from each other,
    - smooth the supply,
    - limit the length of cable.
- **Connect the sensor with supply switched off.**

### Setting-up precautions

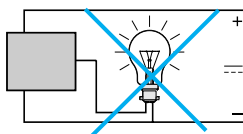
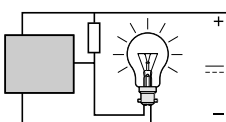
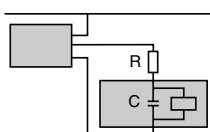
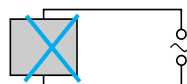
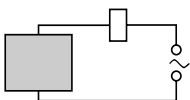
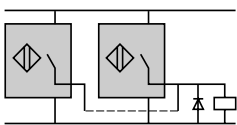
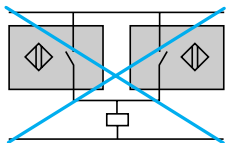
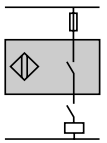
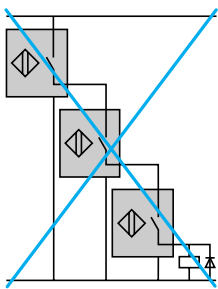
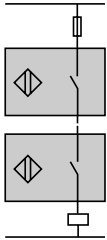

### Connection in series

#### 2-wire type sensors

- The following points should be taken into account:
  - Series wiring is only possible using sensors with wide voltage limits. Based on the assumption that each sensor has the same residual current value, each sensor, in the open state, will share the supply voltage, i.e.

$$U_{\text{sensor}} = \frac{U_{\text{supply}}}{n \text{ sensors}}$$

U sensor and U supply must remain within the sensor's voltage limits.

- If only one sensor in the circuit is in the open state, it will be supplied at a voltage almost equal to the supply voltage.
- When in the closed state, a small voltage drop is present across each sensor. The resultant loss of voltage at the load will be the sum of the individual voltage drops and therefore, the load voltage should be selected accordingly.

#### 3-wire type sensors

This connection method is not recommended.

- Correct operation of the sensors cannot be assured and, if this method is used, tests should be made before installation. The following points should be taken into account:
  - Sensor 1 carries the load current in addition to the no-load current consumption values of the other sensors connected in series. For certain models, this connection method is not possible unless a current limiting resistor is used.
  - When in the closed state, a small voltage drop is present across each sensor. The load should therefore be selected accordingly.
  - As sensor 1 closes, sensor 2 does not operate until a certain time (t) has elapsed (corresponding to the first-up delay) and likewise for the following sensors in the sequence.
  - The use of "flywheel" diodes is recommended when an inductive load is being switched.

### Sensors and devices in series with an external mechanical contact

#### 2 and 3-wire type sensors

- The following points should be taken into account:
  - When the mechanical contact is open, the sensor is not supplied.
  - When the contact closes, the sensor does not operate until a certain time (t) has elapsed (corresponding to the first-up delay).

### Connection in parallel

#### 2-wire type sensors

This connection method is not recommended.

- Should one of the sensors be in the closed state, the sensor in parallel will be "shorted-out" and no longer supplied. As the first sensor passes into the open state, the second sensor will become energised and will be subject to its first-up delay.
  - This configuration is only permissible where the sensors will be working alternately.
  - This method of connection can lead to irreversible damage of the units.

#### 3-wire type sensors

- No specific restrictions. The use of "flywheel" diodes is recommended when an inductive load (relay) is being switched.

### AC supply

■ 2-wire type sensors cannot be connected directly to an AC supply.

- This would result in immediate destruction of the sensor and considerable danger to the user.
- An appropriate load (refer to the instruction sheet supplied with the sensor) must always be connected in series with the sensor.

### Capacitive load (C > 0.1 μF)

- On power-up, it is necessary to limit (by resistor) the charging current of the capacitive load C.
- The voltage drop in the sensor can also be taken into account by subtracting it from the supply voltage for the calculation of R.

$$R = \frac{U_{\text{supply}}}{I_{\text{max. (sensor)}}$$

### Load comprising an incandescent lamp

- If the load comprises an incandescent lamp, the cold state resistance can be 10 times lower than the hot state resistance. This can cause very high current levels on switching. Fit a pre-heat resistor in parallel with the sensor.

$$R = \frac{U^2}{P} \times 10, U = \text{supply voltage and } P = \text{lamp power}$$

### Fast trouble shooting guide

Problem	Possible causes	Remedy
<b>The sensor's output will not change state when a metal object enters the detection zone</b>	On a flush mountable sensor using teach mode: setting-up or programming error.	<ul style="list-style-type: none"> <li>■ After a RESET, follow the environment teach mode procedure. Refer to instruction sheet supplied with sensor.</li> </ul>
	Output stage faulty or complete failure of the sensor or the short-circuit protection has tripped.	<ul style="list-style-type: none"> <li>■ Check that the sensor is compatible with the supply being used.</li> <li>■ Check the load current characteristics:                             <ul style="list-style-type: none"> <li>□ if load current <math>I \geq</math> maximum switching capacity, an auxiliary relay, of the CAD N type for example, should be interposed between the sensor and the load,</li> <li>□ if <math>I \leq</math> maximum switching capacity, check for wiring faults (short-circuit).</li> </ul> </li> <li>■ In all cases, a 0.4 A "quick-blow" fuse should be fitted in series with the sensor.</li> </ul>
	Wiring error	<ul style="list-style-type: none"> <li>■ Check that the wiring conforms to the wiring shown on the sensor label or instruction sheet.</li> </ul>
	Supply fault	<ul style="list-style-type: none"> <li>■ Check that the sensor is compatible with the supply (<math>\sim</math> or <math>\text{---}</math>).</li> <li>■ Check that the supply voltage is within the voltage limits of the sensor. Remember that with a rectified, smoothed supply, <math>U_{\text{peak}} = U_{\text{nominal}} \times \sqrt{2}</math> with a ripple voltage <math>\leq 10\%</math>.</li> </ul>
<b>False or erratic operation, with or without the presence of a metal object in the detection zone</b>	On flush mountable sensor using teach mode: setting-up or programming error.	<ul style="list-style-type: none"> <li>■ After a RESET, follow the environment teach mode procedure. Refer to instruction sheet supplied with sensor.</li> </ul>
	Influence of background or metal environment	<ul style="list-style-type: none"> <li>■ Refer to the instruction sheet supplied with the sensor. For sensors with adjustable sensitivity, reduce the sensing distance.</li> </ul>
	Sensing distance poorly defined for the object to be detected	<ul style="list-style-type: none"> <li>■ Apply the correction coefficients.</li> <li>■ Realign the system or run the teach mode again.</li> </ul>
	Influence of transient interference on the supply lines	<ul style="list-style-type: none"> <li>■ Ensure that any DC supplies, when derived from rectified AC, are correctly smoothed (<math>C &gt; 400 \mu\text{F}</math>).</li> <li>■ Separate AC power cables from low-level DC cables (24 V low level).</li> <li>■ Where very long distances are involved, use suitable cable: screened and twisted pairs of the correct cross-sectional area.</li> </ul>
	Equipment prone to emitting electromagnetic interference	<ul style="list-style-type: none"> <li>■ Position the sensors as far away as possible from any sources of interference.</li> </ul>
	Response time of the sensor too slow for the particular object being detected	<ul style="list-style-type: none"> <li>■ Check the suitability of the sensor for the position or size of the object to be detected.</li> <li>■ If necessary, select a sensor with a higher switching frequency.</li> </ul>
	Influence of high temperature	<ul style="list-style-type: none"> <li>■ Eliminate sources of radiated heat or protect the sensor casing with a heat shield.</li> <li>■ Realign, having adjusted the temperature around the fixing support.</li> </ul>
	<b>No detection following a period of service</b>	Vibration, shock

# Inductive proximity sensors

## OsiSense XS

### Flush mountability using teach mode: simplicity through innovation

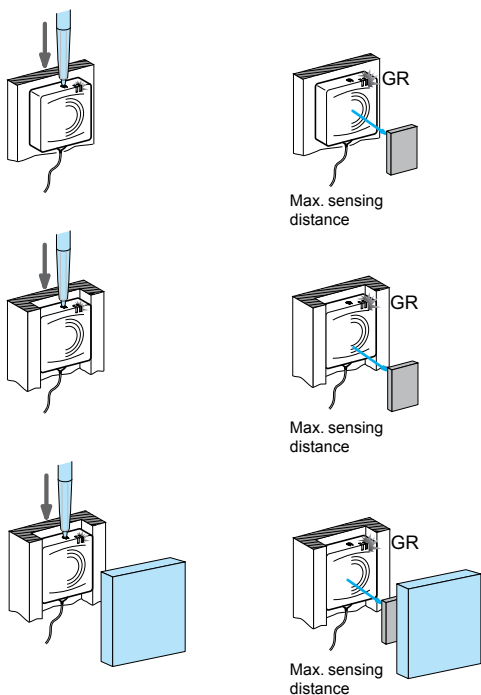

#### Operating principle

In proposing flush mountable sensors using teach mode, Telemecanique Sensors offers simplicity through innovation.

■ A single product enables flush mounting using teach mode and meets all the requirements for inductive detection of metal objects.

By simply pressing the "Teach mode" button, the sensor automatically acquires optimum configuration for all detection, flush mountability and environment requirements.

■ Other advantages of flush mountable sensors using teach mode

- Increased performance:
  - sensing distance guaranteed and optimised irrespective of the mounting method, object, environment or background,
  - suitable for all metal environments.
- Simplified use provided by:
  - the flush mountability using teach mode technology, associated with the availability of the flattest and most compact sensors on the market, ensures full integration in the machine and limits the risks of mechanical damage,
  - mechanical adjustments no longer necessary due to teach mode.
- Lower costs due to:
  - the elimination of adjustment times and complex supports
  - the elimination of flush mountable and non flush mountable versions, which halves the number of references,
  - much easier and much quicker product selection.

#### Precision position detection

All flush mountable inductive proximity sensors using teach mode benefit from ultra precise adjustment, which is very quick irrespective of the metal environment.

■ Precision side approach detection makes it possible to accurately define the distance at which the object will be detected as it passes the sensor.

On the flush mountable sensors using teach mode, the desired detection position can be stored in memory by simply pressing the teach button.

■ Precision frontal approach detection makes it possible to accurately define the distance at which the object will be detected as it approaches the sensor.

On the flush mountable sensors using teach mode, the desired detection position can be stored in memory by simply pressing the teach button.

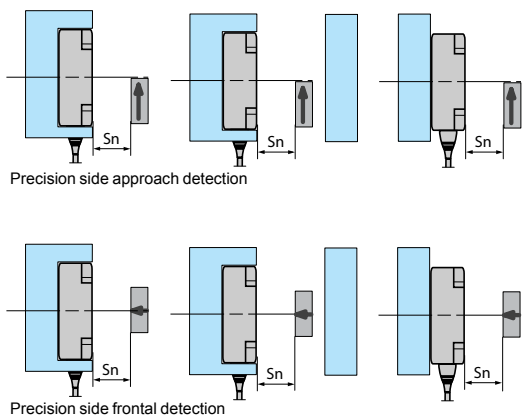

#### Mounting accessories

Telemecanique Sensors offers a complete, inexpensive range of mounting accessories (clamps, plates, brackets, etc.) that provide solutions for all installation problems.

■ Fixing kits for quick installation or replacement of sensors

■ No adjustment required. Simple clipping-in enables the sensor to be fixed in position and ready for operation.

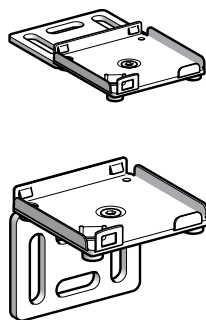

# Inductive proximity sensors

## OsiSense XS

Flush mountability using teach mode:  
simplicity through innovation



### Block type

<b>Dimensions (mm)</b>		26 x 26 x 13	40 x 40 x 15	80 x 80 x 26
<b>Sensing distance (mm)</b>	Flush mounted use	0...10	0...15	0...40
	Non flush mounted use	0...15	0...25	0...60
<b>Sensor type</b>		<b>XS8E1A1</b>	<b>XS8C1A1</b>	<b>XS8D1A1</b>
<b>Page</b>		80		



### Cylindrical type

<b>Dimensions (mm)</b>		12	18	30
<b>Sensing distance (mm)</b>	Flush mounted use	0...3.4	0...6	0...11
	Non flush mounted use	0...5	0...9	0...18
<b>Sensor type</b>		<b>XS612B2</b>	<b>XS618B2</b>	<b>XS630B2</b>
<b>Page</b>		78		



# Inductive proximity sensors

OsiSense XS, general purpose

Cylindrical, standard range, flush mountable

Three-wire DC, solid-state output

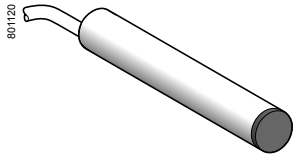

XS506B1●●L2

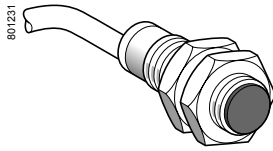

XS508B1●●L2

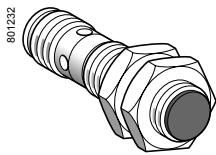

XS512B1●●M12

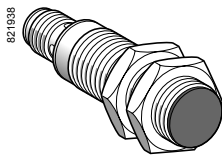

XS518B1●●M12

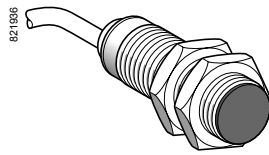

XS518B1●●L2

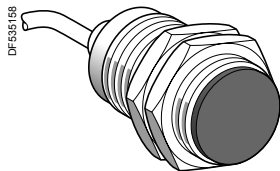

XS530B1●●L2

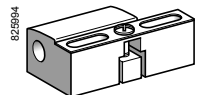

XSZB1●●

## Sensors, 3-wire $\overline{DC}$ 12-24 V, short case model

Sensing distance (Sn) mm	Function	Output	Connection	Reference	Weight kg
<b>Ø 6.5, plain</b>					
1.5	NO	PNP	Pre-cabled (L = 2 m) (1)	<b>XS506B1PAL2</b>	0.035
			M8 connector	<b>XS506B1PAM8</b>	0.025
			M12 connector	<b>XS506B1PAM12</b>	0.025
	NPN	PNP	Pre-cabled (L = 2 m) (1)	<b>XS506B1NAL2</b>	0.035
			M8 connector	<b>XS506B1NAM8</b>	0.025
			M12 connector	<b>XS506B1NAM12</b>	0.025
NC	PNP	Pre-cabled (L = 2 m) (1)	<b>XS506B1PBL2</b>	0.035	
		M8 connector	<b>XS506B1PBM8</b>	0.025	
		M12 connector	<b>XS506B1PBM12</b>	0.025	
NPN	PNP	Pre-cabled (L = 2 m) (1)	<b>XS506B1NBL2</b>	0.035	
		M8 connector	<b>XS506B1NBM8</b>	0.025	
		M12 connector	<b>XS506B1NBM12</b>	0.025	

### Ø 8, threaded M8 x 1

1.5	NO	PNP	Pre-cabled (L = 2 m) (1)	<b>XS508B1PAL2</b>	0.035
			M8 connector	<b>XS508B1PAM8</b>	0.025
			M12 connector	<b>XS508B1PAM12</b>	0.025
			Pre-cabled (L = 2 m) (1)	<b>XS508B1NAL2</b>	0.035
	NPN	PNP	M8 connector	<b>XS508B1NAM8</b>	0.025
			M12 connector	<b>XS508B1NAM12</b>	0.025
			Pre-cabled (L = 2 m) (1)	<b>XS508B1PBL2</b>	0.035
			M8 connector	<b>XS508B1PBM8</b>	0.025
	NC	PNP	M12 connector	<b>XS508B1PBM12</b>	0.025
			Pre-cabled (L = 2 m) (1)	<b>XS508B1NBL2</b>	0.035
			M8 connector	<b>XS508B1NBM8</b>	0.025
			M12 connector	<b>XS508B1NBM12</b>	0.025

### Ø 12, threaded M12 x 1

2	NO	PNP	Pre-cabled (L = 2 m) (1)	<b>XS512B1PAL2</b>	0.075
			M12 connector	<b>XS512B1PAM12</b>	0.035
	NPN	PNP	Pre-cabled (L = 2 m) (1)	<b>XS512B1NAL2</b>	0.075
			M12 connector	<b>XS512B1NAM12</b>	0.035
	NC	PNP	Pre-cabled (L = 2 m) (1)	<b>XS512B1PBL2</b>	0.075
			M12 connector	<b>XS512B1PBM12</b>	0.035
NPN	PNP	Pre-cabled (L = 2 m) (1)	<b>XS512B1NBL2</b>	0.075	
		M12 connector	<b>XS512B1NBM12</b>	0.035	

### Ø 18, threaded M18 x 1

5	NO	PNP	Pre-cabled (L = 2 m) (1)	<b>XS518B1PAL2</b>	0.120
			M12 connector	<b>XS518B1PAM12</b>	0.060
	NPN	PNP	Pre-cabled (L = 2 m) (1)	<b>XS518B1NAL2</b>	0.120
			M12 connector	<b>XS518B1NAM12</b>	0.060
	NC	PNP	Pre-cabled (L = 2 m) (1)	<b>XS518B1PBL2</b>	0.120
			M12 connector	<b>XS518B1PBM12</b>	0.060
NPN	PNP	Pre-cabled (L = 2 m) (1)	<b>XS518B1NBL2</b>	0.120	
		M12 connector	<b>XS518B1NBM12</b>	0.060	

### Ø 30, threaded M30 x 1.5

10	NO	PNP	Pre-cabled (L = 2 m) (1)	<b>XS530B1PAL2</b>	0.205
			M12 connector	<b>XS530B1PAM12</b>	0.145
	NPN	PNP	Pre-cabled (L = 2 m) (1)	<b>XS530B1NAL2</b>	0.205
			M12 connector	<b>XS530B1NAM12</b>	0.145
	NC	PNP	Pre-cabled (L = 2 m) (1)	<b>XS530B1PBL2</b>	0.205
			M12 connector	<b>XS530B1PBM12</b>	0.145
NPN	PNP	Pre-cabled (L = 2 m) (1)	<b>XS530B1NBL2</b>	0.205	
		M12 connector	<b>XS530B1NBM12</b>	0.145	

## Accessories (2)

Description	For use with sensors	Reference	Weight kg
Fixing clamps	Ø 6.5 (plain)	<b>XSZB165</b>	0.005
	Ø 8	<b>XSZB108</b>	0.006
	Ø 12	<b>XSZB112</b>	0.006
	Ø 18	<b>XSZB118</b>	0.010
	Ø 30	<b>XSZB130</b>	0.020

(1) For a 5 m long cable replace L2 by L5; for a 10 m long cable replace L2 by L10.

Example: **XS508B1PAL2** becomes **XS508B1PAL5** with a 5 m long cable.

(2) For further information, see page 128.

# Inductive proximity sensors

OsiSense XS, general purpose

Cylindrical, standard range, flush mountable

Three-wire DC, solid-state output

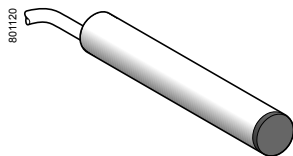

XS506BL●●L2

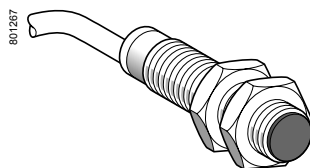

XS5●●BL●●L2

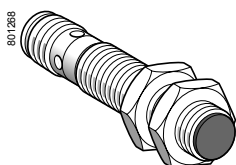

XS5●●BL●●M12

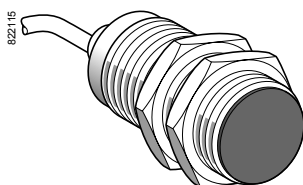

XS530BL●●L2

## Sensors, 3-wire $\overline{\text{DC}}$ 12-48 V, long case model

Sensing distance (Sn) mm	Function	Output	Connection	Reference	Weight kg
<b>Ø 6.5, plain</b>					
1.5	NO	PNP	Pre-cabled (L = 2 m) (1)	<b>XS506BLPAL2</b>	0.035
			M12 connector	<b>XS506BLNAL2</b>	0.035

### Ø 8, threaded M8 x 1

1.5	NO	PNP	Pre-cabled (L = 2 m) (1)	<b>XS508BLPAL2</b>	0.035
			M12 connector	<b>XS508BLPAM12</b>	0.025
	NPN	Pre-cabled (L = 2 m) (1)	<b>XS508BLNAL2</b>	0.035	
		M12 connector	<b>XS508BLNAM12</b>	0.025	
	NC	PNP	Pre-cabled (L = 2 m) (1)	<b>XS508BLPBL2</b>	0.035
			M12 connector	<b>XS508BLPBM12</b>	0.025
NPN	Pre-cabled (L = 2 m) (1)	<b>XS508BLNBL2</b>	0.035		
	M12 connector	<b>XS508BLNBM12</b>	0.025		

### Ø 12, threaded M12 x 1

2	NO	PNP	Pre-cabled (L = 2 m) (1)	<b>XS512BLPAL2</b>	0.075
			M12 connector	<b>XS512BLPAM12</b>	0.035
	NPN	Pre-cabled (L = 2 m) (1)	<b>XS512BLNAL2</b>	0.075	
		M12 connector	<b>XS512BLNAM12</b>	0.035	
	NC	PNP	Pre-cabled (L = 2 m) (1)	<b>XS512BLPBL2</b>	0.075
			M12 connector	<b>XS512BLPBM12</b>	0.035
NPN	Pre-cabled (L = 2 m) (1)	<b>XS512BLNBL2</b>	0.075		
	M12 connector	<b>XS512BLNBM12</b>	0.035		

### Ø 18, threaded M18 x 1

5	NO	PNP	Pre-cabled (L = 2 m) (1)	<b>XS518BLPAL2</b>	0.120
			M12 connector	<b>XS518BLPAM12</b>	0.060
	NPN	Pre-cabled (L = 2 m) (1)	<b>XS518BLNAL2</b>	0.120	
		M12 connector	<b>XS518BLNAM12</b>	0.060	
	NC	PNP	Pre-cabled (L = 2 m) (1)	<b>XS518BLPBL2</b>	0.120
			M12 connector	<b>XS518BLPBM12</b>	0.060
NPN	Pre-cabled (L = 2 m) (1)	<b>XS518BLNBL2</b>	0.120		
	M12 connector	<b>XS518BLNBM12</b>	0.060		

### Ø 30, threaded M30 x 1.5

10	NO	PNP	Pre-cabled (L = 2 m) (1)	<b>XS530BLPAL2</b>	0.205
			M12 connector	<b>XS530BLPAM12</b>	0.145
	NPN	Pre-cabled (L = 2 m) (1)	<b>XS530BLNAL2</b>	0.205	
		M12 connector	<b>XS530BLNAM12</b>	0.145	
	NC	PNP	Pre-cabled (L = 2 m) (1)	<b>XS530BLPBL2</b>	0.205
			M12 connector	<b>XS530BLPBM12</b>	0.145
NPN	Pre-cabled (L = 2 m) (1)	<b>XS530BLNBL2</b>	0.205		
	M12 connector	<b>XS530BLNBM12</b>	0.145		

## Accessories (2)

Description	For use with sensors	Reference	Weight kg
Fixing clamps	Ø 6.5 (plain)	<b>XSZB165</b>	0.005
	Ø 8	<b>XSZB108</b>	0.006
	Ø 12	<b>XSZB112</b>	0.006
	Ø 18	<b>XSZB118</b>	0.010
	Ø 30	<b>XSZB130</b>	0.020

(1) For a 5 m long cable replace L2 by L5; for a 10 m long cable replace L2 by L10.

Example: **XS508BLPAL2** becomes **XS508BLPAL5** with a 5 m long cable.

(2) For further information, see page 128.

# Inductive proximity sensors

OsiSense XS, general purpose

Cylindrical, standard range, flush mountable

Three-wire DC, solid-state output

Characteristics			
Sensor type		XS5●●B1●●M8, XS5●●B1●●M12 XS5●●BL●●M8, XS5●●BL●●M12	XS5●●B1●●L2 XS5●●BL●●L2
Product certifications		UL, CSA, CE	
Connection	Connector	M8 on Ø 6.5 and Ø 8, M12 on Ø 8, Ø 12, Ø 18 and Ø 30	–
	Pre-cabled	–	Length: 2 m
Operating zone	Ø 6.5 and Ø 8	mm	0...1.2
	Ø 12	mm	0...1.6
	Ø 18	mm	0...4
	Ø 30	mm	0...8
Differential travel		%	1...15 of effective sensing distance (Sr)
Degree of protection	Conforming to IEC 60529	IP 65 and IP 67	IP 65 and IP 68, double insulation ☐ (except Ø 6.5 and Ø 8: IP 67)
	Conforming to DIN 40050	IP 69K for Ø 12 to Ø 30	
Storage temperature		°C	-40...+85
Operating temperature		°C	-25...+70
Materials	Case	Nickel plated brass (except XS506 and XS508BL: stainless steel, grade 303)	
	Sensing face	PPS	
	Cable	–	PvR 3 x 0.34 mm <sup>2</sup> except <b>XS506</b> and <b>XS508</b> : 3 x 0.11 mm <sup>2</sup>
Vibration resistance	Conforming to IEC 60068-2-6	25 gn, amplitude ± 2 mm (f = 10 to 50 Hz)	
Shock resistance	Conforming to IEC 60068-2-27	50 gn, duration 11 ms	
Output state indication		Yellow LED: 4 viewing ports at 90°	Yellow LED: annular
Rated supply voltage		V	⎯ 12...48 for XS5●●BL, ⎯ 12...24 for XS5●●B1 with protection against reverse polarity
Voltage limits (including ripple)		V	⎯ 10...58 for XS5●●BL, ⎯ 10...36 for XS5●●B1
Switching capacity		mA	≤ 200 with overload and short-circuit protection
Voltage drop, closed state		V	≤ 2
Current consumption, no-load		mA	≤ 10
Maximum switching frequency	XS506, XS508, XS512	Hz	5000
	XS518	Hz	2000
	XS530	Hz	1000
Delays	First-up	ms	≤ 10
	Response	ms	≤ 0.1: <b>XS506</b> , <b>XS508</b> and <b>XS512</b> ≤ 0.15: <b>XS518</b> ≤ 0.3: <b>XS530</b>
	Recovery	ms	≤ 0.1: <b>XS506</b> , <b>XS508</b> and <b>XS512</b> ≤ 0.35: <b>XS518</b> ≤ 0.7: <b>XS530</b>

# Inductive proximity sensors

OsiSense XS, general purpose

Cylindrical, standard range, flush mountable

Three-wire DC, solid-state output

## Wiring schemes

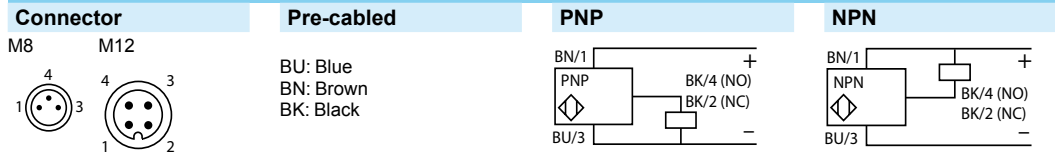

For M8 connector, NO and NC outputs on terminal 4

## Setting-up

### Minimum mounting distances (mm)

Flush mountable sensors	Side by side	Face to face	Facing a metal object
Ø 6.5	$e \geq 3$	$e \geq 18$	$e \geq 4.5$
Ø 8	$e \geq 3$	$e \geq 18$	$e \geq 4.5$
Ø 12	$e \geq 4$	$e \geq 24$	$e \geq 6$
Ø 18	$e \geq 10$	$e \geq 60$	$e \geq 15$
Ø 30	$e \geq 20$	$e \geq 120$	$e \geq 30$

## Dimensions

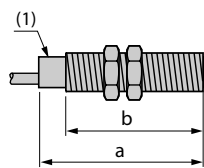

(1) LED

Sensors		Pre-cabled (mm)		M8 connector (mm)		M12 connector (mm)	
Short case model		a	b	a	b	a	b
Ø 6.5	<b>XS506B1</b>	33	–	42	–	45	–
Ø 8	<b>XS508B1</b>	33	25	42	26	45	24
Ø 12	<b>XS512B1</b>	35	25	–	–	50	30
Ø 18	<b>XS518B1</b>	39	28	–	–	50	28
Ø 30	<b>XS530B1</b>	43	32	–	–	55	32

Sensors		Pre-cabled (mm)		M12 connector (mm)	
Long case model		a	b	a	b
Ø 6.5	<b>XS506BL</b>	51	–	–	–
Ø 8	<b>XS508BL</b>	51	42	62	40
Ø 12	<b>XS512BL</b>	53	42	62	42
Ø 18	<b>XS518BL</b>	62	52	74	52
Ø 30	<b>XS530BL</b>	62	52	74	52

# Inductive proximity sensors

OsiSense XS, general purpose

Cylindrical, standard range, flush mountable

Two-wire DC

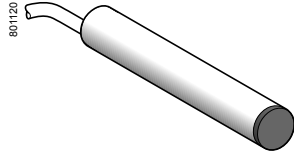

XS506BS●●L2

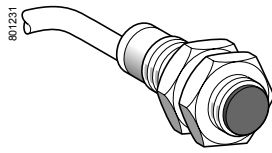

XS512BS●●L2

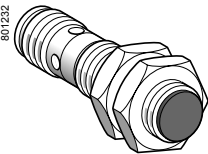

XS5●●BS●●M12

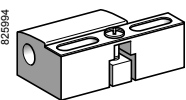

XSZB1●●

## Sensors, 2-wire ~ 12-24 V, short case model

Sensing distance (Sn) mm	Function	Connection	Reference	Weight kg
<b>Ø 6.5, plain</b>				
1.5	NO	Pre-cabled (L = 2 m) (1)	<b>XS506BSCAL2</b>	0.035
	NC	Remote M12 connector	<b>XS506BSCAL01M12</b>	0.050
		Pre-cabled (L = 2 m) (1)	<b>XS506BSCBL2</b>	0.035
<b>Ø 8, threaded M8 x 1</b>				
1.5	NO	Pre-cabled (L = 2 m) (1)	<b>XS508BSCAL2</b>	0.035
	terminals 1 & 4 (2)	Remote M12 connector	<b>XS508BSCAL01M12</b>	0.050
		Remote M12 connector	<b>XS508BSCAL08M12</b>	0.050
	NC	Pre-cabled (L = 2 m) (1)	<b>XS508BSCBL2</b>	0.035
		Remote M12 connector	<b>XS508BSCBL01M12</b>	0.050
<b>Ø 12, threaded M12 x 1</b>				
2	NO	Pre-cabled (L = 2 m) (1)	<b>XS512BSDAL2</b>	0.075
		M12 connector	<b>XS512BSDAM12</b>	0.035
	NO terminals 1 & 4 (2)	M12 connector	<b>XS512BSCAM12</b>	0.035
		Remote M12 connector	<b>XS512BSCAL08M12</b>	0.060
NC	Pre-cabled (L = 2 m) (1)	<b>XS512BSDBL2</b>	0.075	
		M12 connector	<b>XS512BSDBM12</b>	0.035
<b>Ø 18, threaded M18 x 1</b>				
5	NO	Pre-cabled (L = 2 m) (1)	<b>XS518BSDAL2</b>	0.120
		M12 connector	<b>XS518BSDAM12</b>	0.060
	NO terminals 1 & 4 (2)	M12 connector	<b>XS518BSCAM12</b>	0.060
		Remote M12 connector	<b>XS518BSCAL08M12</b>	0.085
	NC	Pre-cabled (L = 2 m) (1)	<b>XS518BSDBL2</b>	0.120
			M12 connector	<b>XS518BSDBM12</b>
<b>Ø 30, threaded M30 x 1.5</b>				
10	NO	Pre-cabled (L = 2 m) (1)	<b>XS530BSDAL2</b>	0.205
		M12 connector	<b>XS530BSDAM12</b>	0.145
	NO terminals 1 & 4 (2)	M12 connector	<b>XS530BSCAM12</b>	0.145
		Remote M12 connector	<b>XS530BSCAL08M12</b>	0.170
	NC	Pre-cabled (L = 2 m) (1)	<b>XS530BSDBL2</b>	0.205
			M12 connector	<b>XS530BSDBM12</b>
<b>Accessories (3)</b>				
Description	For use with sensors	Reference	Weight kg	
Fixing clamps	Ø 6.5 (plain)	<b>XSZB165</b>	0.005	
	Ø 8	<b>XSZB108</b>	0.006	
	Ø 12	<b>XSZB112</b>	0.006	
	Ø 18	<b>XSZB118</b>	0.010	
	Ø 30	<b>XSZB130</b>	0.020	

(1) For a 5 m long cable replace L2 by L5; for a 10 m long cable replace L2 by L10.

Example: XS508BSCAL2 becomes XS508BSCAL5 with a 5 m long cable.

(2) The NO output is connected to terminals 1 and 4 of the M12 connector.

(3) For further information, see page 128.

# Inductive proximity sensors

OsiSense XS, general purpose

Cylindrical, standard range, flush mountable

Two-wire DC

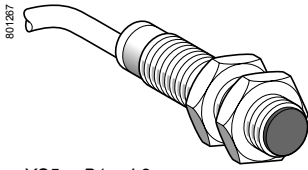

XS5●●B1●●L2

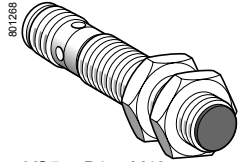

XS5●●B1●●M12

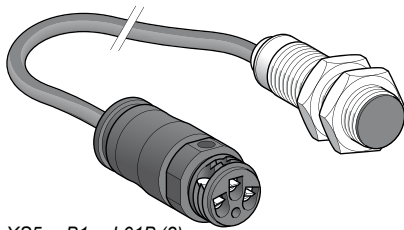

XS5●●B1●●L01B (2)

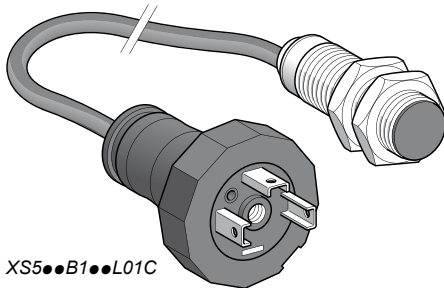

XS5●●B1●●L01C

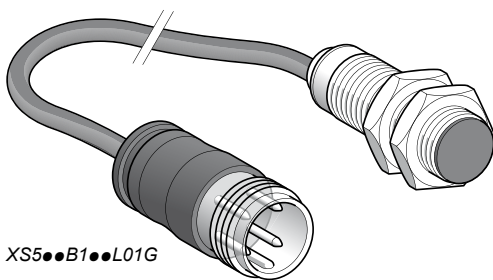

XS5●●B1●●L01G

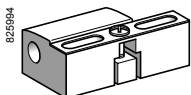

XSZB1●●

## Sensors, 2-wire ~ 12-48 V, long case model

Sensing distance (Sn) mm	Function	Connection	Reference	Weight kg	
<b>Ø 8, threaded M8 x 1</b>					
1.5	NO	Pre-cabled (L = 2 m) (1)	XS508B1DAL2	0.035	
		Remote M12 connector	XS508B1DAL08M12	0.050	
		M12 connector	XS508B1DAM12	0.025	
NO terminals 1 & 4 (3)	M12 connector	XS508B1CAM12	0.025		
	Remote M12 connector	XS508B1CAL08M12	0.050		
NC		Pre-cabled (L = 2 m) (1)	XS508B1DBL2	0.035	
		M12 connector	XS508B1DBM12	0.025	
<b>Ø 12, threaded M12 x 1</b>					
2	NO	Pre-cabled (L = 2 m) (1)	XS512B1DAL2	0.075	
		Remote 7/8" connector	XS512B1DAL08U78	0.050	
		M12 connector	XS512B1DAM12	0.035	
NO terminals 1 & 4 (3)	M12 connector	XS512B1CAM12	0.035		
	Remote M12 connector	XS512B1CAL08M12	0.060		
NC		Pre-cabled (L = 2 m) (1)	XS512B1DBL2	0.075	
		M12 connector	XS512B1DBM12	0.035	
		Remote M12 connector	XS512B1DBL08M12	0.060	
<b>Ø 18, threaded M18 x 1</b>					
5	NO	Pre-cabled (L = 2 m) (1)	XS518B1DAL2	0.120	
		Low temperature version (- 40 °C)	XS518B1DAL2TF (5)	0.120	
		Remote screw terminal connector (2)	XS518B1DAL01B	0.085	
		Remote EN 175301-803-A connector	XS518B1DAL01C	0.085	
		Remote M18 connector	XS518B1DAL01G	0.085	
		M12 connector	XS518B1DAM12	0.060	
		NO terminals 1 & 4 (3)	M12 connector	XS518B1CAM12	0.060
			Remote M12 connector	XS518B1CAL08M12	0.085
		NC		Pre-cabled (L = 2 m) (1)	XS518B1DBL2
M12 connector	XS518B1DBM12			0.060	
Remote M12 connector	XS518B1DBL08M12			0.085	
		Remote screw terminal connector (2)	XS518B1DBL01B	0.120	
<b>Ø 30, threaded M30 x 1.5</b>					
10	NO	Pre-cabled (L = 2 m) (1)	XS530B1DAL2	0.205	
		Low temperature version (- 40 °C)	XS530B1DAL2TF (5)	0.205	
		M12 connector	XS530B1DAM12	0.145	
		Remote screw terminal connector (2)	XS530B1DAL01B	0.205	
		Remote EN 175301-803-A connector	XS530B1DAL01C	0.205	
		Remote M18 connector	XS530B1DAL01G	0.205	
		NO terminals 1 & 4 (3)	M12 connector	XS530B1CAM12	0.145
			Remote M12 connector	XS530B1CAL08M12	0.170
		NC		Pre-cabled (L = 2 m) (1)	XS530B1DBL2
M12 connector	XS530B1DBM12			0.145	
Remote screw terminal connector (2)	XS530B1DBL01B			0.205	

## Accessories (4)

Description	For use with sensors	Reference	Weight kg
Fixing clamps	Ø 8	XSZB108	0.006
	Ø 12	XSZB112	0.006
	Ø 18	XSZB118	0.010
	Ø 30	XSZB130	0.020

(1) For a 5 m long cable replace L2 by L5; for a 10 m long cable replace L2 by L10.

Example: XS508B1DAL2 becomes XS508B1DAL5 with a 5 m long cable.

(2) Protective cable gland included with sensor.

(3) The NO output is connected to terminals 1 and 4 of the M12 connector.

(4) For further information, see page 128.

(5) For a 5 m long cable replace L2 by L5.

Example: XS518B1DAL2TF becomes XS518B1DAL5TF with a 5 m long cable.

For a PUR cable, replace the letter L by P in the reference.

Example: XS518B1DAL2TF becomes XS518B1DAP2TF.

For a 5 m long cable replace P2 by P5.

Example: XS518B1DAP2TF becomes XS518B1DAP5TF with a 5 m long cable.

# Inductive proximity sensors

OsiSense XS, general purpose

Cylindrical, standard range, flush mountable

Two-wire DC

Characteristics			XS5●●B1●●M12, XS5●●BS●●M12	XS5●●B1D●L2, XS5●●BS●●L2
Sensor type			UL, CSA, CÉ	
Product certifications			UL, CSA, CÉ	
Connection	Connector		M12	–
	Pre-cabled		–	Length: 2 m
	Remote connector		M12 (L01M12), screw terminal (L01B), EN 175301-803-A (L01C) and M18 (L01G) remote connectors, on 0.15 m flying lead. M12 (L08M12) and 7/8" (L08U78) remote connectors, on 0.80 m flying lead	
Operating zone	Ø 6.5	mm	0...1.2	
	Ø 8	mm	0...1.2	
	Ø 12	mm	0...1.6	
	Ø 18	mm	0...4	
	Ø 30	mm	0...8	
Differential travel		%	1...15 of effective sensing distance (Sr)	
Degree of protection	Conforming to IEC 60529		IP 65 and IP 67	IP 65 and IP 68, double insulation ☐ (except Ø 6.5 and Ø 8: IP 67)
Storage temperature		°C	- 40...+ 85	
Operating temperature		°C	- 25...+ 70; TF products: - 40...+ 70	
Materials	Case		Nickel plated brass (except XS506 and XS508B1: stainless steel, grade 303)	
	Sensing face		PPS	
	Cable		–	PvR 2 x 0.34 mm <sup>2</sup> (except XS506 and XS508: 2 x 0.11 mm <sup>2</sup> ) PUR available (1)
Vibration resistance	Conforming to IEC 60068-2-6		25 gn, amplitude ± 2 mm (f = 10 to 55 Hz)	
Shock resistance	Conforming to IEC 60068-2-27		50 gn, duration 11 ms	
Output state indication			Yellow LED: 4 viewing ports at 90°	Yellow LED: annular
Rated supply voltage		V	≒ 12...48 non polarised for XS5●●B1●, ≒ 12...24 non polarised for XS5●●BS (except Ø 6.5 short and Ø 8 short: polarised) with protection against reverse polarity	
Voltage limits (including ripple)		V	≒ 10...58 for XS5●●B1●, ≒ 10...36 for XS5●●BS	
Switching capacity		mA	1.5...100 with overload and short-circuit protection	
Voltage drop, closed state		V	≤ 4.2	
Residual current, open state		mA	≤ 0.5	
Maximum switching frequency	XS506, XS508	Hz	1000 for XS5●●BS, 1400 for XS5●●B1●	
	XS512	Hz	1000	
	XS518	Hz	1200	
	XS530	Hz	1300	
Delays	First-up	ms	≤ 10	
	Response	ms	≤ 0.5: XS506, XS508 and XS512 ≤ 0.6: XS518 ≤ 0.6: XS530	
	Recovery	ms	≤ 0.2 (except XS530 ≤ 0.4)	

(1) For PUR cable, replace the letter L in the reference by P. Example: XS506BSCAL2 becomes XS506BSCAP2 with PUR cable.



# Inductive proximity sensors

OsiSense XS, general purpose

Cylindrical, standard range, flush mountable

Two-wire DC

## Wiring schemes

Connector	Pre-cabled	2-wire $\overline{\text{---}}$ non polarised		
M12	BU: Blue BN: Brown	<b>NO output</b> XS5●●B1DA●●●	XS5●●B1CA●●●	<b>NC output</b> XS5●●B1DB●●●
		2-wire $\overline{\text{---}}$ polarised		
		<b>NO output</b> XS5●●BSCA●●●		<b>NC output</b> XS5●●BSCB●●●

## Remote connectors L01B, L01C, L01G

### Screw terminal (L01B)

The terminal numbering differs according to the version (2-wire  $\overline{\text{---}}$ , 3-wire  $\overline{\text{---}}$ , 2-wire  $\overline{\text{~}}$ ).

### EN 175301-803-A (L01C)

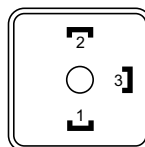

### M18 (L01G)

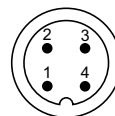

The NO or NC outputs are connected to terminal 2.

## Setting-up

### Minimum mounting distances (mm)

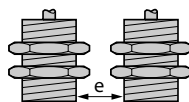

#### Side by side

Ø 6.5	$e \geq 3$
Ø 8	$e \geq 3$
Ø 12	$e \geq 4$
Ø 18	$e \geq 10$
Ø 30	$e \geq 20$

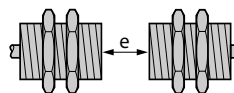

#### Face to face

$e \geq 18$
$e \geq 18$
$e \geq 24$
$e \geq 60$
$e \geq 120$

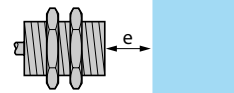

#### Facing a metal object

$e \geq 4.5$
$e \geq 4.5$
$e \geq 6$
$e \geq 15$
$e \geq 30$

## Dimensions

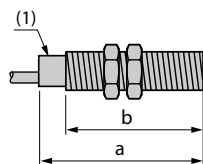

(1) LED

Sensors		Pre-cabled (mm)		M8 connector (mm)		M12 connector (mm)	
Short case model		a	b	a	b	a	b
Ø 6.5	XS506BS	33	–	42	–	45	–
Ø 8	XS508BS	33	25	42	26	45	24
Ø 12	XS512BS	35	25	–	–	50	30
Ø 18	XS518BS	39	28	–	–	50	28
Ø 30	XS530BS	43	32	–	–	55	32
Sensors		Pre-cabled (mm)		M12 connector (mm)			
Long case model		a	b	a	b		
Ø 8	XS508B1	51	42	62	40		
Ø 12	XS512B1	53	42	62	42		
Ø 18	XS518B1	62	52	74	52		
Ø 30	XS530B1	62	52	74	52		



# Inductive proximity sensors

OsiSense XS, general purpose

Cylindrical, standard range, flush mountable

Two-wire AC or DC <sup>(1)</sup>

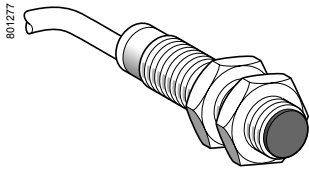

XS5●●B1M●L2

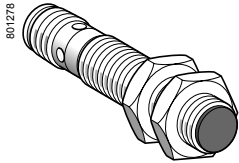

XS5●●B1M●U20

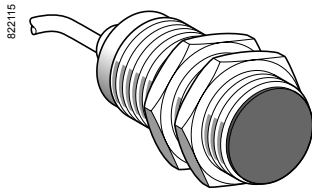

XS530B1●●L2

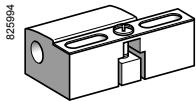

XSZB1●●

### Sensors, 2-wire ~ 24-240 V, long case model

Ø 12, threaded M12 x 1

Sensing distance (Sn) mm	Function	Connection	Reference	Weight kg
2	NO	Pre-cabled (L = 2 m) (2)	<b>XS512B1MAL2</b>	0.075
		1/2"-20UNF connector	<b>XS512B1MAU20</b>	0.025
	NC	Pre-cabled (L = 2 m) (2)	<b>XS512B1MBL2</b>	0.075
		1/2"-20UNF connector	<b>XS512B1MBU20</b>	0.025

Ø 18, threaded M18 x 1

Sensing distance (Sn) mm	Function	Connection	Reference	Weight kg
5	NO	Pre-cabled (L = 2 m) (2)	<b>XS518B1MAL2</b>	0.100
		1/2"-20UNF connector	<b>XS518B1MAU20</b>	0.060
	NC	Pre-cabled (L = 2 m) (2)	<b>XS518B1MBL2</b>	0.100
		1/2"-20UNF connector	<b>XS518B1MBU20</b>	0.060

Ø 30, threaded M30 x 1.5

Sensing distance (Sn) mm	Function	Connection	Reference	Weight kg
10	NO	Pre-cabled (L = 2 m) (2)	<b>XS530B1MAL2</b>	0.205
		1/2"-20UNF connector	<b>XS530B1MAU20</b>	0.145
	NC	Pre-cabled (L = 2 m) (2)	<b>XS530B1MBL2</b>	0.205
		1/2"-20UNF connector	<b>XS530B1MBU20</b>	0.145

### Accessories (3)

Description	For use with sensors	Reference	Weight kg
Fixing clamps	Ø 12	<b>XSZB112</b>	0.006
	Ø 18	<b>XSZB118</b>	0.010
	Ø 30	<b>XSZB130</b>	0.020

(1) Ø8 plastic, double insulation, version available: see page 66.

(2) For a 5 m long cable replace L2 by L5; for a 10 m long cable replace L2 by L10.

Example: **XS512B1MAL2** becomes **XS512B1MAL5** with a 5 m long cable.

(3) For further information, see page 128.

# Inductive proximity sensors

OsiSense XS, general purpose

Cylindrical, standard range, flush mountable

Two-wire AC or DC

Characteristics		XS5●●B1M●U20	XS5●●B1M●L2
Sensor type			
Product certifications		UL, CSA, CE	
Connection	Connector	1/2"-20UNF	
	Pre-cabled	-	
Operating zone	Ø 12	mm	0...1.6
	Ø 18	mm	0...4
	Ø 30	mm	0...8
Differential travel		%	
		1...15 of effective sensing distance (Sr)	
Degree of protection	Conforming to IEC 60529	IP 65 and IP 67	
	Conforming to DIN 40050	IP 69K	
Storage temperature		°C	
		- 40...+ 85	
Operating temperature		°C	
		- 25...+ 70	
Materials	Case	Nickel plated brass	
	Sensing face	PPS	
	Cable	-	
		PvR 2 x 0.34 mm <sup>2</sup>	
Vibration resistance	Conforming to IEC 60068-2-6	25 gn, amplitude ± 2 mm (f = 10 to 55 Hz)	
Shock resistance	Conforming to IEC 60068-2-27	50 gn, duration 11 ms	
Output state indication		Yellow LED: 4 viewing ports at 90°	
		Yellow LED: annular	
Rated supply voltage		V	
		~ or ≐ 24...240 (~ 50/60 Hz)	
Voltage limits (including ripple)		V	
		~ or ≐ 20...264	
Switching capacity	XS512B1M●●●	mA	5...200 (1)
	XS518B1M●●●, XS530B1M●●●	mA	~ 5...300 or ≐ 5...200 (1)
Voltage drop, closed state		V	
		≤ 5.5	
Residual current, open state		mA	
		≤ 0.8	
Maximum switching frequency	XS512B1●●●, XS518B1M●●●	Hz	~ 25 or ≐ 1000
	XS530B1M●●●	Hz	~ 25 or ≐ 500
Delays	First-up	ms	≤ 20 XS512B1M●●●, ≤ 25 XS518B1M●●● and XS530B1M●●●
	Response	ms	≤ 0.5
	Recovery	ms	≤ 0.2 XS512B1M●●●, ≤ 0.5 XS518B1M●●●, ≤ 2 XS530B1M●●●

(1) It is essential to connect a 0.4 A "quick-blow" fuse in series with the load.

## Wiring schemes

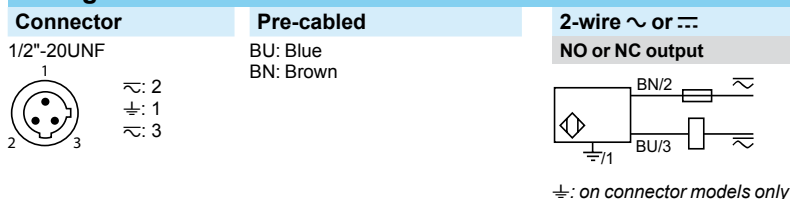

## Setting-up

### Minimum mounting distances (mm)

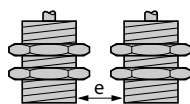

Sensor	Side by side
Ø 12	e ≥ 8
Ø 18	e ≥ 16
Ø 30	e ≥ 30

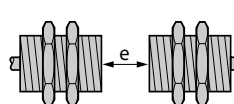

Sensor	Face to face
Ø 12	e ≥ 48
Ø 18	e ≥ 100
Ø 30	e ≥ 180

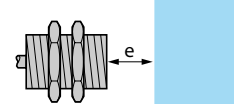

Sensor	Facing a metal object
Ø 12	e ≥ 12
Ø 18	e ≥ 25
Ø 30	e ≥ 45

## Dimensions

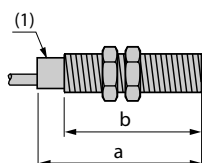

(1) LED

Sensor	XS6			
	Pre-cabled (mm)		Connector (mm)	
	a	b	a	b
XS512B1M	53	42	62	42
XS518B1M	62	52	73	52
XS530B1M	62	52	73	52

# Inductive proximity sensors

OsiSense XS, general purpose

Cylindrical, increased range, flush mountable

Three-wire DC, solid-state output

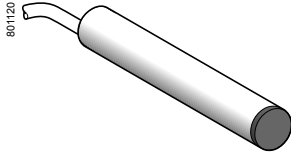

XS106B3●●L2

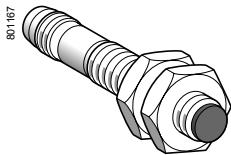

XS108B3●●M8

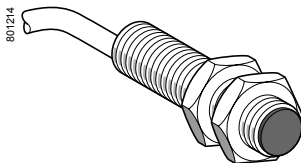

XS112B3●●L2

### Sensors, 3-wire $\overline{\text{DC}}$ 12-24 V, short case model

Sensing distance (Sn) mm	Function	Output	Connection	Sold in lots of	Reference unit	Weight kg			
<b>Ø 6.5, plain</b>									
2.5	NO	PNP	Pre-cabled (L = 2 m) (1)	1	XS106B3PAL2	0.060			
			M8 connector	1	XS106B3PAM8	0.030			
			M12 connector	1	XS106B3PAM12	0.050			
			Pre-cabled (L = 2 m)	20	XS106B3PAL2TQ	0.980			
			M8 connector	20	XS106B3PAM8TQ	0.320			
			M12 connector	20	XS106B3PAM12TQ	0.320			
	NC	PNP	Pre-cabled (L = 2 m) (1)	1	XS106B3PBL2	0.060			
			M8 connector	1	XS106B3PBM8	0.030			
			M12 connector	1	XS106B3PBM12	0.030			
			Pre-cabled (L = 2 m) (1)	1	XS106B3NBL2	0.060			
			M8 connector	1	XS106B3NBM8	0.030			
			M12 connector	1	XS106B3NBM12	0.030			
<b>Ø 8, threaded M8 x 1</b>									
2.5	NO	PNP	Pre-cabled (L = 2 m) (1)	1	XS108B3PAL2	0.070			
			M8 connector	1	XS108B3PAM8	0.030			
			M12 connector	1	XS108B3PAM12	0.060			
			Pre-cabled (L = 2 m)	20	XS108B3PAL2TQ	1.120			
			M8 connector	20	XS108B3PAM8TQ	0.460			
			M12 connector	20	XS108B3PAM12TQ	0.940			
			NPN	Pre-cabled (L = 2 m) (1)	1	XS108B3NAL2	0.070		
				M8 connector	1	XS108B3NAM8	0.030		
				M12 connector	1	XS108B3NAM12	0.060		
				Pre-cabled (L = 2 m)	20	XS108B3NAL2TQ	1.120		
				M8 connector	20	XS108B3NAM8TQ	0.460		
				M12 connector	20	XS108B3NAM12TQ	0.940		
	NC	PNP	Pre-cabled (L = 2 m) (1)	1	XS108B3PBL2	0.070			
			M8 connector	1	XS108B3PBM8	0.030			
			M12 connector	1	XS108B3PBM12	0.060			
			Pre-cabled (L = 2 m) (1)	1	XS108B3NBL2	0.070			
			M8 connector	1	XS108B3NBM8	0.030			
			M12 connector	1	XS108B3NBM12	0.060			
	<b>Ø 12, threaded M12 x 1</b>								
	4	NO	PNP	Pre-cabled (L = 2 m) (1)	1	XS112B3PAL2	0.090		
				M12 connector	1	XS112B3PAM12	0.030		
				Pre-cabled (L = 2 m)	20	XS112B3PAL2TQ	1.600		
				M12 connector	20	XS112B3PAM12TQ	0.470		
				NPN	Pre-cabled (L = 2 m) (1)	1	XS112B3NAL2	0.090	
M12 connector					1	XS112B3NAM12	0.030		
Pre-cabled (L = 2 m)					20	XS112B3NAL2TQ	1.600		
M12 connector					20	XS112B3NAM12TQ	0.470		
NC					PNP	Pre-cabled (L = 2 m) (1)	1	XS112B3PBL2	0.090
						M12 connector	1	XS112B3PBM12	0.030
				M12 connector		20	XS112B3PBM12TQ	0.470	
				Pre-cabled (L = 2 m) (1)		1	XS112B3NBL2	0.090	
		M12 connector	1	XS112B3NBM12		0.030			
		M12 connector	20	XS112B3NBM12TQ		0.030			

(1) For a 5 m long cable replace L2 by L5.

Example: XS106B3PAL2 becomes XS106B3PAL5 with a 5 m long cable.

## Inductive proximity sensors

OsiSense XS, general purpose

Cylindrical, increased range, flush mountable

Three-wire DC, solid-state output

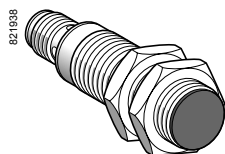

XS118B3●●M12

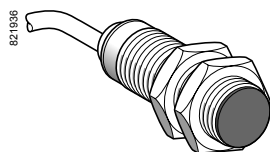

XS118B3●●L2

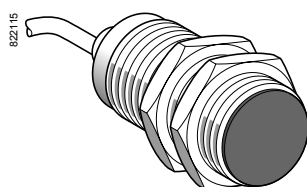

XS130B3●●L2

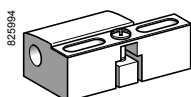

XSZB1●●

Sensors, 3-wire  $\overline{\text{DC}}$  12-24 V, short case model (continued)

Sensing distance (Sn) mm	Function	Output	Connection	Sold in lots of	Unit reference	Weight kg
<b>Ø 18, threaded M18 x 1</b>						
8	NO	PNP	Pre-cabled (L = 2 m) (1)	1	XS118B3PAL2	0.110
			M12 connector	1	XS118B3PAM12	0.060
	NPN	PNP	Pre-cabled (L = 2 m)	20	XS118B3PAL2TQ	2.000
			M12 connector	20	XS118B3PAM12TQ	1.140
		NPN	Pre-cabled (L = 2 m) (1)	1	XS118B3NAL2	0.110
			M12 connector	1	XS118B3NAM12	0.060
NC	PNP	PNP	Pre-cabled (L = 2 m)	20	XS118B3NAL2TQ	2.000
			M12 connector	20	XS118B3NAM12TQ	1.140
	NPN	PNP	Pre-cabled (L = 2 m) (1)	1	XS118B3PBL2	0.110
			M12 connector	1	XS118B3PBM12	0.060
		NPN	Pre-cabled (L = 2 m) (1)	1	XS118B3NBL2	0.110
			M12 connector	1	XS118B3NBM12	0.060
<b>Ø 30, threaded M30 x 1.5</b>						
15	NO	PNP	Pre-cabled (L = 2 m) (1)	1	XS130B3PAL2	0.180
			M12 connector	1	XS130B3PAM12	0.130
	NPN	PNP	Pre-cabled (L = 2 m)	20	XS130B3PAL2TQ	3.360
			M12 connector	20	XS130B3PAM12TQ	2.000
		NPN	Pre-cabled (L = 2 m) (1)	1	XS130B3NAL2	0.180
			M12 connector	1	XS130B3NAM12	0.130
NC	PNP	PNP	M12 connector	20	XS130B3NAM12TQ	2.000
			Pre-cabled (L = 2 m) (1)	1	XS130B3PBL2	0.180
	NPN	PNP	M12 connector	1	XS130B3PBM12	0.130
			Pre-cabled (L = 2 m) (1)	1	XS130B3NBL2	0.180
		NPN	M12 connector	1	XS130B3NBM12	0.130

## Accessories (2)

Description	For use with sensors	Reference	Weight kg
Fixing clamps	Ø 6.5 (plain)	XSZB165	0.005
	Ø 8 (M8 x 1)	XSZB108	0.006
	Ø 12 (M12 x 1)	XSZB112	0.006
	Ø 18 (M18 x 1)	XSZB118	0.010
	Ø 30 (M30 x 1.5)	XSZB130	0.020

(1) For a 5 m long cable replace L2 by L5.

Example: XS118B3PAL2 becomes XS118B3PAL5 with a 5 m long cable.

(2) For further information, see page 128.

# Inductive proximity sensors

OsiSense XS, general purpose

Cylindrical, increased range, flush mountable

Three-wire DC, solid-state output

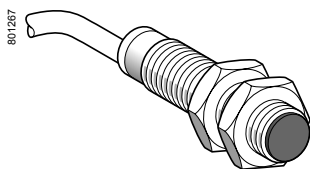

XS6●●B1●●L2

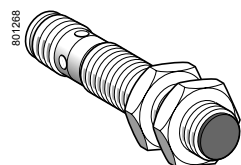

XS6●●B1●●M12

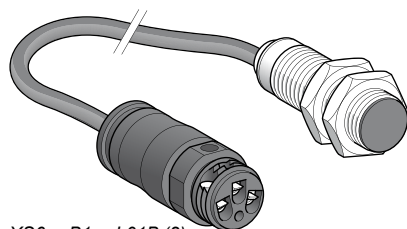

XS6●●B1●●L01B (2)

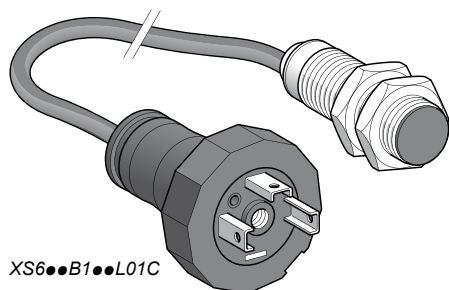

XS6●●B1●●L01C

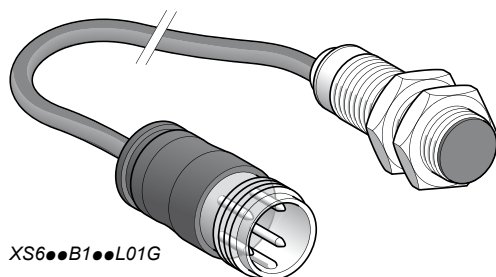

XS6●●B1●●L01G

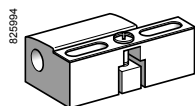

XSZB●●●

## Sensors, 3-wire ~ 12-48 V, long case model

Sensing distance (Sn) mm	Function	Output	Connection	Reference	Weight kg
<b>Ø 8, threaded M8 x 1</b>					
2.5	NO	PNP	Pre-cabled (L = 2 m) (1)	XS608B1PAL2	0.035
			M12 connector	XS608B1PAM12	0.015
	NPN	PNP	Pre-cabled (L = 2 m) (1)	XS608B1NAL2	0.035
			M12 connector	XS608B1NAM12	0.015
	NC	PNP	Pre-cabled (L = 2 m) (1)	XS608B1PBL2	0.035
			M12 connector	XS608B1PBM12	0.015
NPN	PNP	Pre-cabled (L = 2 m) (1)	XS608B1NBL2	0.035	
		M12 connector	XS608B1NBM12	0.015	
<b>Ø 12, threaded M12 x 1</b>					
4	NO	PNP	Pre-cabled (L = 2 m) (1)	XS612B1PAL2	0.075
			M12 connector	XS612B1PAM12	0.020
	NPN	PNP	Pre-cabled (L = 2 m) (1)	XS612B1NAL2	0.075
			M12 connector	XS612B1NAM12	0.020
	NC	PNP	Pre-cabled (L = 2 m) (1)	XS612B1PBL2	0.075
			M12 connector	XS612B1PBM12	0.020
NPN	PNP	Pre-cabled (L = 2 m) (1)	XS612B1NBL2	0.075	
		M12 connector	XS612B1NBM12	0.020	
<b>Ø 18, threaded M18 x 1</b>					
8	NO	PNP	Pre-cabled (L = 2 m) (1)	XS618B1PAL2	0.100
			M12 connector	XS618B1PAM12	0.040
			Remote screw terminal connector	XS618B1PAL01B (2)	0.100
			Remote EN 175301-803-A connector	XS618B1PAL01C	0.100
			Remote M18 connector	XS618B1PAL01G	0.100
			M12 connector	XS618B1NAM12	0.040
	NPN	PNP	Pre-cabled (L = 2 m) (1)	XS618B1NAL2	0.100
			M12 connector	XS618B1NAM12	0.040
			Remote screw terminal connector	XS618B1NAL01B (2)	0.100
			Remote EN 175301-803-A connector	XS618B1NAL01C	0.100
			Remote M18 connector	XS618B1NAL01G	0.100
			M12 connector	XS618B1NAM12	0.040
	NC	PNP	Pre-cabled (L = 2 m) (1)	XS618B1PBL2	0.100
			M12 connector	XS618B1PBM12	0.040
			Remote screw terminal connector	XS618B1PBL01B (2)	0.100
			Remote EN 175301-803-A connector	XS618B1PBL01C	0.100
			Remote M18 connector	XS618B1PBL01G	0.100
			M12 connector	XS618B1PBM12	0.040
NPN	PNP	Pre-cabled (L = 2 m) (1)	XS618B1NBL2	0.100	
		M12 connector	XS618B1NBM12	0.040	
		Remote screw terminal connector	XS618B1NBL01B (2)	0.100	
		Remote EN 175301-803-A connector	XS618B1NBL01C	0.100	
		Remote M18 connector	XS618B1NBL01G	0.100	
		M12 connector	XS618B1NBM12	0.040	
<b>Ø 30, threaded M30 x 1.5</b>					
15	NO	PNP	Pre-cabled (L = 2 m) (1)	XS630B1PAL2	0.205
			M12 connector	XS630B1PAM12	0.145
			Remote screw terminal connector	XS630B1PAL01B (2)	0.205
			Remote EN 175301-803-A connector	XS630B1PAL01C	0.205
			Remote M18 connector	XS630B1PAL01G	0.205
			M12 connector	XS630B1NAM12	0.145
	NPN	PNP	Pre-cabled (L = 2 m) (1)	XS630B1NAL2	0.205
			M12 connector	XS630B1NAM12	0.145
			Remote screw terminal connector	XS630B1NAL01B (2)	0.205
			Remote EN 175301-803-A connector	XS630B1NAL01C	0.205
			Remote M18 connector	XS630B1NAL01G	0.205
			M12 connector	XS630B1NAM12	0.145
	NC	PNP	Pre-cabled (L = 2 m) (1)	XS630B1PBL2	0.205
			M12 connector	XS630B1PBM12	0.145
			Remote screw terminal connector	XS630B1PBL01B (2)	0.205
			Remote EN 175301-803-A connector	XS630B1PBL01C	0.205
			Remote M18 connector	XS630B1PBL01G	0.205
			M12 connector	XS630B1PBM12	0.145
NPN	PNP	Pre-cabled (L = 2 m) (1)	XS630B1NBL2	0.205	
		M12 connector	XS630B1NBM12	0.145	
		Remote screw terminal connector	XS630B1NBL01B (2)	0.205	
		Remote EN 175301-803-A connector	XS630B1NBL01C	0.205	
		Remote M18 connector	XS630B1NBL01G	0.205	
		M12 connector	XS630B1NBM12	0.145	

## Accessories (3)

Description	For use with sensors	Reference	Weight kg
Fixing clamps	Ø 8	XSZB108	0.006
	Ø 12	XSZB112	0.006
	Ø 18	XSZB118	0.010
	Ø 30	XSZB130	0.020

(1) For a 5 m long cable replace L2 by L5; for a 10 m long cable replace L2 by L10.

Example: XS608B1PAL2 becomes XS608B1PAL5 with a 5 m long cable.

(2) Protective cable gland included with sensor.

(3) For further information, see page 128.

Characteristics		XS1/XS6●●B●●M8	XS1/XS6●●B●●M12	XS1/XS6●●B●●L2
Sensor type		UL, CSA, CE		
Product certifications		UL, CSA, CE		
Connection	Connector	M8	M12	–
	Pre-cabled	–	–	Length 2 m
	Remote connector	Remote screw terminal (L01B), EN 175301-803-A (L01C) and M18 (L01G) connectors, on 0.15 m flying lead.		
Operating zone (1)	Ø 6.5 and Ø 8	mm	0...2	
	Ø 12	mm	0...3.2	
	Ø 18	mm	0...6.4	
	Ø 30	mm	0...12	
Differential travel		%		
Degree of protection		Conforming to IEC 60529		
		IP 65 and IP 67		
		IP 65 and IP 68, double insulation  except Ø 6.5 and Ø 8: IP 67		
		Conforming to DIN 40050		
		IP 69K for Ø 12, 18 and 30 sensors		
Storage temperature		°C - 40...+ 85		
Operating temperature		°C - 25...+ 70		
Materials	Case	Nickel plated brass (except XS608: stainless steel, grade 303)		
	Sensing face	PPS		
	Cable	–		
		PvR 3 x 0.34 mm <sup>2</sup> except Ø 6.5 and 8: 3 x 0.11 mm <sup>2</sup>		
Vibration resistance	Conforming to IEC 60068-2-6	25 gn, amplitude ± 2 mm (f = 10 to 55 Hz)		
Shock resistance	Conforming to IEC 60068-2-27	50 gn, duration 11 ms		
Output state indication		Yellow LED, 4 viewing ports at 90°		
		Yellow LED, annular		
Rated supply voltage		V		
		XS1: ≍ 12...24 with protection against reverse polarity XS6: ≍ 12...48 with protection against reverse polarity		
Voltage limits (including ripple)		V		
		XS1: ≍ 10...36; XS6: ≍ 10...58		
Switching capacity		mA ≤ 200 with overload and short-circuit protection		
Voltage drop, closed state		V ≤ 2		
Current consumption, no-load		mA ≤ 10		
Maximum switching frequency	Ø 6.5, Ø 8 and Ø 12	Hz 2500		
	Ø 18	Hz 1000		
	Ø 30	Hz 500		
Delays	First-up	ms ≤ 10		
	Response	ms ≤ 0.2 for Ø 6.5, Ø 8 and Ø 12, ≤ 0.3 for Ø 18, ≤ 0.6 for Ø 30		
	Recovery	ms ≤ 0.2 for Ø 6.5, Ø 8 and Ø 12, ≤ 0.7 for Ø 18, ≤ 1.4 for Ø 30		

(1) Detection curves, see page 132.

## Wiring schemes

### Connector (1)

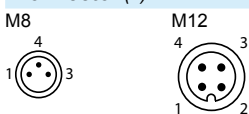

### Pre-cabled

BU: Blue  
BN: Brown  
BK: Black

### PNP

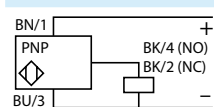

### NPN

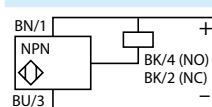

For M8 connector, NO and NC outputs on terminal 4

## Setting-up

### Minimum mounting distances (mm)

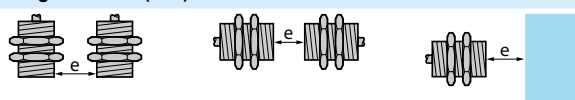

Sensors	Side by side	Face to face	Facing a metal object
Ø 6.5	e ≥ 5	e ≥ 30	e ≥ 8
Ø 8	e ≥ 5	e ≥ 30	e ≥ 8
Ø 12	e ≥ 8	e ≥ 50	e ≥ 12
Ø 18	e ≥ 16	e ≥ 100	e ≥ 25
Ø 30	e ≥ 30	e ≥ 180	e ≥ 45

(1) For pin arrangement of remote connectors L01B, L01C and L01G, see page 31.

## Dimensions

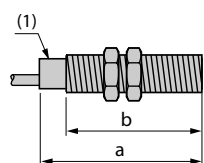

(1) LED

Sensors		Pre-cabled (mm)		M8 connector (mm)		M12 connector (mm)	
Short case model		a	b	a	b	a	b
Ø 6.5	XS106B3	33	–	42	–	45	–
Ø 8	XS108B3	33	25	42	26	45	24
Ø 12	XS112B3	35	25	–	–	50	30
Ø 18	XS118B3	39	28	–	–	50	28
Ø 30	XS130B3	43	32	–	–	55	32

Sensors		Pre-cabled (mm)		M12 connector (mm)	
Long case model		a	b	a	b
Ø 8	XS608B1	51	42	62	40
Ø 12	XS612B1	53	42	62	42
Ø 18	XS618B1	62	52	74	52
Ø 30	XS630B1	62	52	74	52



# Inductive proximity sensors

OsiSense XS, general purpose

Cylindrical, increased range, flush mountable

Two-wire DC, solid-state output

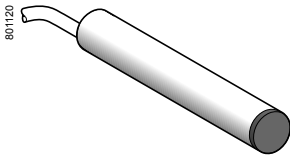

XS606B3●●L2

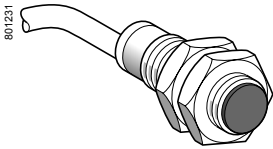

XS612B3●●L2

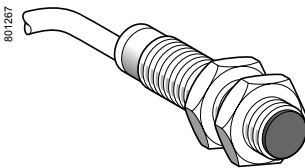

XS6●●B1●●L2

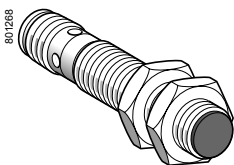

XS6●●B1●●M12

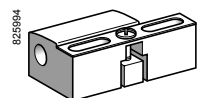

XSZB1●●

## Sensors, 2-wire $\overline{\text{DC}}$ 12-24 V, short case model

Sensing distance (Sn) mm	Function	Connection	Reference	Weight kg
<b>Ø 6.5, plain</b>				
2.5	NO	Pre-cabled (L = 2 m) (1)	XS606B3CAL2	0.060
		Remote M12 connector	XS606B3CAL01M12	0.070
	NC	Pre-cabled (L = 2 m) (1)	XS606B3CBL2	0.060
<b>Ø 8, threaded M8 x 1</b>				
2.5	NO	Pre-cabled (L = 2 m) (1)	XS608B3CAL2	0.070
		Remote M12 connector	XS608B3CAL01M12	0.070
	NC	Pre-cabled (L = 2 m) (1)	XS608B3CBL2	0.070
		Remote M12 connector	XS608B3CBL01M12	0.070
<b>Ø 12, threaded M12 x 1</b>				
4	NO	Pre-cabled (L = 2 m) (1)	XS612B3DAL2	0.090
		M12 connector	XS612B3DAM12	0.030
	NC	Pre-cabled (L = 2 m) (1)	XS612B3DBL2	0.090
		M12 connector	XS612B3DBM12	0.030
<b>Ø 18, threaded M18 x 1</b>				
8	NO	Pre-cabled (L = 2 m) (1)	XS618B3DAL2	0.110
		M12 connector	XS618B3DAM12	0.060
	NC	Pre-cabled (L = 2 m) (1)	XS618B3DBL2	0.110
		M12 connector	XS618B3DBM12	0.060
<b>Ø 30, threaded M30 x 1.5</b>				
15	NO	Pre-cabled (L = 2 m) (1)	XS630B3DAL2	0.180
		M12 connector	XS630B3DAM12	0.130
	NC	Pre-cabled (L = 2 m) (1)	XS630B3DBL2	0.180
		M12 connector	XS630B3DBM12	0.180

## Sensors, 2-wire $\overline{\text{DC}}$ 12-48 V, long case model

Sensing distance (Sn) mm	Function	Connection	Reference	Weight kg
<b>Ø 6.5, plain</b>				
2.5	NO	Pre-cabled (L = 2 m) (1)	XS606B1DAL2	0.060
		Pre-cabled (L = 2 m) (1)	XS606B1DBL2	0.060
<b>Ø 8, threaded M8 x 1</b>				
2.5	NO	Pre-cabled (L = 2 m) (1)	XS608B1DAL2	0.035
		M12 connector	XS608B1DAM12	0.015
	NC	Pre-cabled (L = 2 m) (1)	XS608B1DBL2	0.035
		M12 connector	XS608B1DBM12	0.015
<b>Ø 12, threaded M12 x 1</b>				
4	NO	Pre-cabled (L = 2 m) (1)	XS612B1DAL2	0.180
		M12 connector	XS612B1DAM12	0.020
	NC	Pre-cabled (L = 2 m) (1)	XS612B1DBL2	0.075
		M12 connector	XS612B1DBM12	0.020
<b>Ø 18, threaded M18 x 1</b>				
8	NO	Pre-cabled (L = 2 m) (1)	XS618B1DAL2	0.100
		M12 connector	XS618B1DAM12	0.040
	NC	Pre-cabled (L = 2 m) (1)	XS618B1DBL2	0.100
		M12 connector	XS618B1DBM12	0.040
<b>Ø 30, threaded M30 x 1.5</b>				
15	NO	Pre-cabled (L = 2 m) (1)	XS630B1DAL2	0.205
		M12 connector	XS630B1DAM12	0.145
	NC	Pre-cabled (L = 2 m) (1)	XS630B1DBL2	0.205
		M12 connector	XS630B1DBM12	0.145

## Accessories (2)

Description	For use with sensors	Reference	Weight kg
Fixing clamps	Ø 6.5 (plain)	XSZB165	0.005
	Ø 8 (M8 x 1)	XSZB108	0.006
	Ø 12 (M12 x 1)	XSZB112	0.006
	Ø 18 (M18 x 1)	XSZB118	0.010
	Ø 30 (M30 x 1.5)	XSZB130	0.020

(1) For a 5 m long cable replace L2 by L5.

Example: XS606B3CAL2 becomes XS606B3CAL5 with a 5 m long cable.

(2) For further information, see page 128.



Characteristics		XS6●●B3●●M12 XS6●●B1D●●M12	XS6●●B3●●L2 XS6●●B1D●●L2
Sensor type		UL, CSA, CE	
Product certifications		UL, CSA, CE	
Connection		M12 connector or remote M12 connector (L01M12) on 0.15 m flying lead	
Pre-cabled		Length 2 m	
Operating zone (1)		mm	0...2
Ø 12		mm	0...3.2
Ø 18		mm	0...6.4
Ø 30		mm	0...12
Differential travel		%	1...15 of effective sensing distance (Sr)
Degree of protection		Conforming to IEC 60529	
		IP 65 and IP 67	
		IP 65 and IP 68, double insulation □ (except Ø 6.5 and Ø 8: IP 67)	
		Conforming to DIN 40050	
		IP 69K	
Storage temperature		°C - 40...+ 85	
Operating temperature		°C - 25...+ 70	
Materials		Case	
		Nickel plated brass (except XS606B1D and XS608B1D: stainless steel, grade 303)	
		Sensing face	
		PPS	
		Cable	
		PvR 2 x 0.34 mm <sup>2</sup> except Ø 6.5 and Ø 8: 2 x 0.11 mm <sup>2</sup>	
Vibration resistance		Conforming to IEC 60068-2-6	
		25 gn, amplitude ± 2 mm (f = 10 to 55 Hz)	
Shock resistance		Conforming to IEC 60068-2-27	
		50 gn, duration 11 ms	
Output state indication		Yellow LED, 4 viewing ports at 90°	
Rated supply voltage		V	
		--- 12...48 non polarised for XS6●●B1D, --- 12...24 non polarised for XS6●●B3● (except Ø 6.5 short and Ø 8 short: polarised), with protection against reverse polarity	
Voltage limits (including ripple)		V	
		--- 10...58 for XS6●●B1D --- 10...36 for XS6●●B3●	
Switching capacity		mA ≤ 100 with overload and short-circuit protection	
Voltage drop, closed state		V ≤ 4.2	
Residual current, open state		mA ≤ 0.5 mA	
Maximum switching frequency		Hz	
Ø 6.5, Ø 8		1400 for XS6●●B1D, 1100 for XS6●●B3●	
Ø 12		1300	
Ø 18		1500	
Ø 30		800	
Delays		ms	
First-up		≤ 10	
Response		≤ 0.5	
Recovery		ms ≤ 0.2 for Ø 6.5, Ø 8 and Ø 12; 0.3 for Ø 18; 0.6 for Ø 30	

(1) Detection curves, see page 132.

Wiring schemes		Setting-up																											
M12 connector		Minimum mounting distances (mm)																											
Pre-cabled																													
BU: Blue BN: Brown																													
2-wire --- non polarised																													
NO output																													
NC output																													
2-wire --- polarised																													
XS6●●B3CA																													
XS6●●B3CB																													
		<table border="1"> <thead> <tr> <th>Sensors</th> <th>Side by side</th> <th>Face to face</th> <th>Facing a metal object</th> </tr> </thead> <tbody> <tr> <td>Ø 6.5</td> <td>e ≥ 5</td> <td>e ≥ 30</td> <td>e ≥ 8</td> </tr> <tr> <td>Ø 8</td> <td>e ≥ 5</td> <td>e ≥ 30</td> <td>e ≥ 8</td> </tr> <tr> <td>Ø 12</td> <td>e ≥ 8</td> <td>e ≥ 50</td> <td>e ≥ 12</td> </tr> <tr> <td>Ø 18</td> <td>e ≥ 16</td> <td>e ≥ 100</td> <td>e ≥ 25</td> </tr> <tr> <td>Ø 30</td> <td>e ≥ 30</td> <td>e ≥ 180</td> <td>e ≥ 45</td> </tr> </tbody> </table>				Sensors	Side by side	Face to face	Facing a metal object	Ø 6.5	e ≥ 5	e ≥ 30	e ≥ 8	Ø 8	e ≥ 5	e ≥ 30	e ≥ 8	Ø 12	e ≥ 8	e ≥ 50	e ≥ 12	Ø 18	e ≥ 16	e ≥ 100	e ≥ 25	Ø 30	e ≥ 30	e ≥ 180	e ≥ 45
Sensors	Side by side	Face to face	Facing a metal object																										
Ø 6.5	e ≥ 5	e ≥ 30	e ≥ 8																										
Ø 8	e ≥ 5	e ≥ 30	e ≥ 8																										
Ø 12	e ≥ 8	e ≥ 50	e ≥ 12																										
Ø 18	e ≥ 16	e ≥ 100	e ≥ 25																										
Ø 30	e ≥ 30	e ≥ 180	e ≥ 45																										

Dimensions		Sensors			
		Pre-cabled (mm)		M12 connector (mm)	
		a	b	a	b
<b>Short case model</b>					
Ø 6.5	XS606B3C	33	—	—	—
Ø 8	XS608B3C	33	25	—	24
Ø 12	XS612B3D	35	25	50	30
Ø 18	XS618B3D	39	28	50	28
Ø 30	XS630B3D	43	32	55	32
<b>Long case model</b>					
Ø 6.5	XS606B1D	51	—	—	—
Ø 8	XS608B1D	51	42	62	40
Ø 12	XS612B1D	53	42	62	42
Ø 18	XS618B1D	62	52	74	52
Ø 30	XS630B1D	62	52	74	52

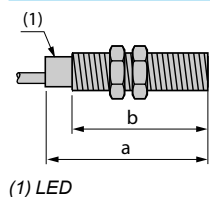

# Inductive proximity sensors

OsiSense XS, general purpose

Cylindrical, increased range, flush mountable

Two-wire AC or DC <sup>(1)</sup>

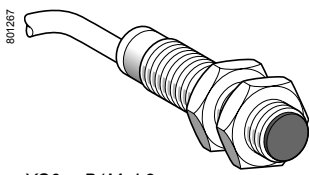

XS6●●B1M●L2

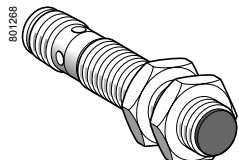

XS6●●B1●●U20

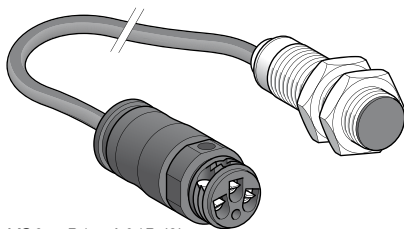

XS6●●B1●●L01B (3)

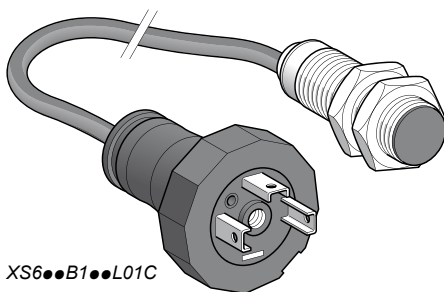

XS6●●B1●●L01C

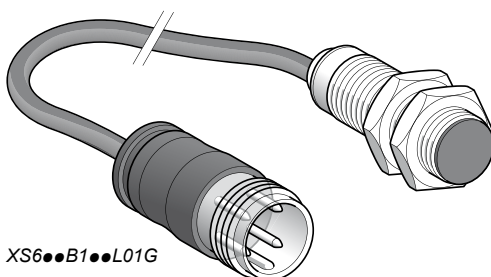

XS6●●B1●●L01G

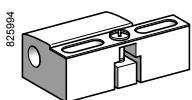

XSZB1●●

## Sensors, 2-wire $\approx$ 24-240 V, long case model

Sensing distance (Sn) mm	Function	Connection	Reference	Weight kg
<b>Ø 12, threaded M12 x 1</b>				
4	NO	Pre-cabled (L = 2 m) (2)	<b>XS612B1MAL2</b>	0.075
		1/2"-20UNF connector	<b>XS612B1MAU20</b>	0.025
	NC	Pre-cabled (L = 2 m) (2)	<b>XS612B1MBL2</b>	0.075
		1/2"-20UNF connector	<b>XS612B1MBU20</b>	0.025

<b>Ø 18, threaded M18 x 1</b>				
8	NO	Pre-cabled (L = 2 m) (2)	<b>XS618B1MAL2</b>	0.100
		1/2"-20UNF connector	<b>XS618B1MAU20</b>	0.060
		Remote screw terminal connector	<b>XS618B1MAL01B (3)</b>	0.100
		Remote EN 175301-803-A connector	<b>XS618B1MAL01C</b>	0.100
	NC	Pre-cabled (L = 2 m) (2)	<b>XS618B1MBL2</b>	0.100
		1/2"-20UNF connector	<b>XS618B1MBU20</b>	0.060
		Remote screw terminal connector	<b>XS618B1MBL01B (3)</b>	0.100
		Remote EN 175301-803-A connector	<b>XS618B1MBL01C</b>	0.100
		Remote M18 connector	<b>XS618B1MAL01G</b>	0.100
		Remote M18 connector	<b>XS618B1MBL01G</b>	0.100

<b>Ø 30, threaded M30 x 1.5</b>				
15	NO	Pre-cabled (L = 2 m) (2)	<b>XS630B1MAL2</b>	0.205
		1/2"-20UNF connector	<b>XS630B1MAU20</b>	0.145
		Remote screw terminal connector	<b>XS630B1MAL01B (3)</b>	0.205
		Remote EN 175301-803-A connector	<b>XS630B1MAL01C</b>	0.205
	NC	Pre-cabled (L = 2 m) (2)	<b>XS630B1MBL2</b>	0.205
		1/2"-20UNF connector	<b>XS630B1MBU20</b>	0.145
		Remote screw terminal connector	<b>XS630B1MBL01B (3)</b>	0.205
		Remote EN 175301-803-A connector	<b>XS630B1MBL01C</b>	0.205
		Remote M18 connector	<b>XS630B1MBL01G</b>	0.205

## Accessories (4)

Description	For use with sensors	Reference	Weight kg
Fixing clamps	Ø 12	<b>XSZB112</b>	0.006
	Ø 18	<b>XSZB118</b>	0.010
	Ø 30	<b>XSZB130</b>	0.020

(1) Ø 8 plastic, double insulation, version available: see page 66.

(2) For a 5 m long cable replace L2 by L5; for a 10 m long cable replace L2 by L10.  
Example: XS612B1MAL2 becomes XS612B1MAL5 with a 5 m long cable.

(3) Protective cable gland included with sensor.

(4) For further information, see page 128.

Characteristics		XS6●●B1M●U20	XS6●●B1M●●
Sensor type		UL, CSA, CÉ	
Product certifications		1/2"-20UNF	
Connection	Connector	–	
	Pre-cabled	Length 2 m	
	Remote connector	Remote screw terminal (L01B), EN 175301-803-A (L01C) and M18 (L01G) connectors, on 0.15 m flying lead.	
Operating zone (1)	Ø 12	mm	0...3.2
	Ø 18	mm	0...6.4
	Ø 30	mm	0...12
Differential travel		%	
Degree of protection	Conforming to IEC 60529	IP 65, IP 67	
	Conforming to DIN 40050	IP 69K	
Storage temperature		°C	
Operating temperature		°C	
Materials	Case	Nickel plated brass	
	Sensing face	PPS	
	Cable	PvR 2 x 0.34 mm <sup>2</sup>	
Vibration resistance	Conforming to IEC 60068-2-6	25 gn, amplitude ± 2 mm (f = 10 to 55 Hz)	
Shock resistance	Conforming to IEC 60068-2-27	50 gn, duration 11 ms	
Output state indication		Yellow LED: annular on pre-cabled version Yellow LED with 4 viewing ports at 90° on connector version	
Rated supply voltage		V	
Voltage limits (including ripple)		V	
Switching capacity	XS612B1M●●●	mA	5...200 (2)
	XS618B1M●●●	mA	~ 5...300 or ≐ 5...200 (2)
	XS630B1M●●●	mA	~ 5...300 or ≐ 5...200 (2)
Voltage drop, closed state		V	
Residual current, open state		mA	
Maximum switching frequency (DC/AC)	Ø 12	Hz	≐ 1000 / ~ 25
	Ø 18	Hz	≐ 1000 / ~ 25
	Ø 30	Hz	≐ 500 / ~ 25
Delays	First-up	ms	≤ 25 for Ø 18 and Ø 30 sensors; ≤ 20 for Ø 12 sensors
	Response	ms	≤ 0.5
	Recovery	ms	≤ 0.2 for Ø 12 sensors; ≤ 0.5 for Ø 18 sensors; ≤ 2 for Ø 30 sensors

(1) Detection curves, see page 132.

(2) It is essential to connect a 0.4 A "quick-blow" fuse in series with the load.

## Wiring schemes

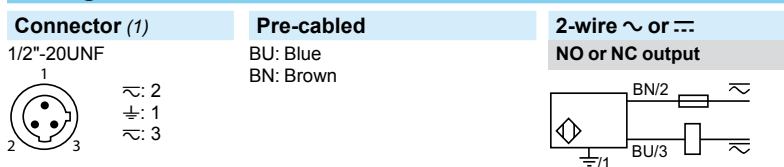

±: on connector models only

(1) For pin arrangement of remote connectors L01B, L01C and L01G, see page 31.

## Setting-up

### Minimum mounting distances (mm)

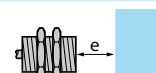
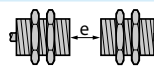
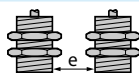

Sensors	Side by side	Face to face	Facing a metal object
Ø 12	e ≥ 8	e ≥ 50	e ≥ 12
Ø 18	e ≥ 16	e ≥ 100	e ≥ 25
Ø 30	e ≥ 30	e ≥ 180	e ≥ 45

## Dimensions

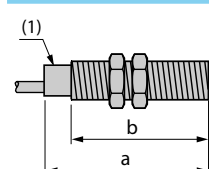

Sensors	Pre-cabled (mm)		Connector (mm)	
	a	b	a	b
Ø 12 XS612B1M●	53	42	62	42
Ø 18 XS618B1M●	62	52	73	52
Ø 30 XS630B1M●	62	52	73	52

(1) LED

# Inductive proximity sensors

OsiSense XS, general purpose  
Cylindrical, increased range, non flush mountable  
Three-wire DC, solid-state output

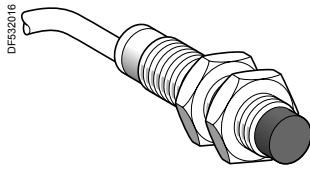

XS612B4●●L2

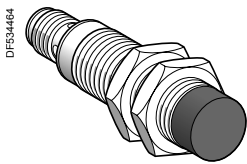

XS618B4●●M12

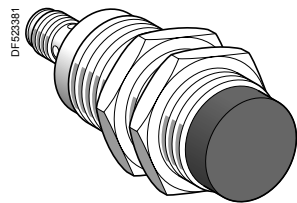

XS630B4●●M12

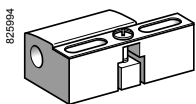

XSZB●●●

### Sensors, 3-wire 12...48 V, long case model

#### Ø 12, threaded M12 x 1

Sensing distance (Sn) mm	Function	Output	Connection	Reference	Weight kg
7	NO	PNP	Pre-cabled (L = 2 m) (1)	<b>XS612B4PAL2</b>	0.075
			M12 connector	<b>XS612B4PAM12</b>	0.020
		NPN	Pre-cabled (L = 2 m) (1)	<b>XS612B4NAL2</b>	0.075
			M12 connector	<b>XS612B4NAM12</b>	0.020
	NC	PNP	Pre-cabled (L = 2 m) (1)	<b>XS612B4PBL2</b>	0.075
			M12 connector	<b>XS612B4PBM12</b>	0.020
		NPN	Pre-cabled (L = 2 m) (1)	<b>XS612B4NBL2</b>	0.075
			M12 connector	<b>XS612B4NBM12</b>	0.020

#### Ø 18, threaded M18 x 1

Sensing distance (Sn) mm	Function	Output	Connection	Reference	Weight kg
12	NO	PNP	Pre-cabled (L = 2 m) (1)	<b>XS618B4PAL2</b>	0.100
			M12 connector	<b>XS618B4PAM12</b>	0.040
		NPN	Pre-cabled (L = 2 m) (1)	<b>XS618B4NAL2</b>	0.100
			M12 connector	<b>XS618B4NAM12</b>	0.040
	NC	PNP	Pre-cabled (L = 2 m) (1)	<b>XS618B4PBL2</b>	0.100
			M12 connector	<b>XS618B4PBM12</b>	0.040
		NPN	Pre-cabled (L = 2 m) (1)	<b>XS618B4NBL2</b>	0.100
			M12 connector	<b>XS618B4NBM12</b>	0.040

#### Ø 30, threaded M30 x 1.5

Sensing distance (Sn) mm	Function	Output	Connection	Reference	Weight kg
22	NO	PNP	Pre-cabled (L = 2 m) (1)	<b>XS630B4PAL2</b>	0.205
			M12 connector	<b>XS630B4PAM12</b>	0.145
		NPN	Pre-cabled (L = 2 m) (1)	<b>XS630B4NAL2</b>	0.205
			M12 connector	<b>XS630B4NAM12</b>	0.145
	NC	PNP	Pre-cabled (L = 2 m) (1)	<b>XS630B4PBL2</b>	0.205
			M12 connector	<b>XS630B4PBM12</b>	0.145
		NPN	Pre-cabled (L = 2 m) (1)	<b>XS630B4NBL2</b>	0.205
			M12 connector	<b>XS630B4NBM12</b>	0.145

### Accessories (2)

Description	For use with sensors	Reference	Weight kg
Fixing clamps	Ø 12	<b>XSZB112</b>	0.006
	Ø 18	<b>XSZB118</b>	0.010
	Ø 30	<b>XSZB130</b>	0.020

(1) For a 5 m long cable replace L2 by L5; for a 10 m long cable replace L2 by L10.

Example: XS612B4PAL2 becomes **XS612B4PAL5** with a 5 m long cable.

(2) For further information, see page 128.

Characteristics		XS6●●B4●●M12	XS6●●B4●●L2
Sensor type		XS6●●B4●●M12	XS6●●B4●●L2
Product certifications		UL, CSA, CE	
Connection	Connector	M12	–
	Pre-cabled	–	Length: 2 m
Operating zone	Ø 12	mm	0...5.6
	Ø 18	mm	0...9.6
	Ø 30	mm	0...17.6
Differential travel		%	
		1...15 of effective sensing distance (Sr)	
Degree of protection		Conforming to IEC 60529	IP 65 and IP 67   IP 65 and IP 68, double insulation □
Storage temperature		°C - 40...+ 85	
Operating temperature		°C - 25...+ 70	
Materials	Case	Nickel plated brass	
	Sensing face	PPS	
	Cable	–	PvR 3 x 0.34 mm <sup>2</sup>
Vibration resistance		Conforming to IEC 60068-2-6	25 gn, amplitude ± 2 mm (f = 10 to 55 Hz)
Shock resistance		Conforming to IEC 60068-2-27	50 gn, duration 11 ms
Output state indication		Yellow LED: 4 viewing ports at 90°	Yellow LED: annular
Rated supply voltage		V $\bar{\bar{}}$ 12...48 with protection against reverse polarity	
Voltage limits (including ripple)		V $\bar{\bar{}}$ 10...58	
Switching capacity		mA $\leq$ 200 with overload and short-circuit protection	
Voltage drop, closed state		V $\leq$ 2	
Current consumption, no-load		mA $\leq$ 10	
Maximum switching frequency	XS612B4●●●●	Hz	2500
	XS618B4●●●●	Hz	1000
	XS630B4●●●●	Hz	500
Delays	First-up	ms	$\leq$ 10
	Response	ms	$\leq$ 0.2 Ø 12, $\leq$ 0.3 Ø 18, $\leq$ 0.6 Ø 30
	Recovery	ms	$\leq$ 0.2 Ø 12, $\leq$ 0.7 Ø 18, $\leq$ 1.4 Ø 30

## Wiring schemes

Connector	Pre-cabled	PNP	NPN
M12 	BU: Blue BN: Brown BK: Black		

## Setting-up

		Minimum mounting distances (mm)		
	Ø 12	<b>Side by side</b>	<b>Face to face</b>	<b>Facing a metal object</b>
	Ø 18	$e \geq 48$	$e \geq 84$	$e \geq 21$
	Ø 30	$e \geq 72$	$e \geq 144$	$e \geq 36$
		$e \geq 120$	$e \geq 264$	$e \geq 66$

## Dimensions

	Pre-cabled (mm)			Connector (mm)		
	a	b	c	a	b	c
XS6 Ø 12	55	42	5	66	42	5
Ø 18	60	44	8	72	44	8
Ø 30	63	41	13	74	41	13

(1) LED

# Inductive proximity sensors

OsiSense XS, general purpose

Cylindrical, increased range, non flush mountable

Two-wire AC or DC

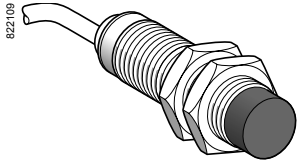

XS6●●B4M●L2

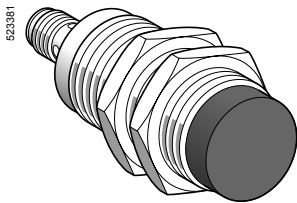

XS6●●B4M●U20

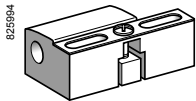

XSZB1●●

### Sensors, 2-wire $\approx$ 24... 240 V, long case model

#### Ø 18, threaded M18 x 1

Sensing distance (Sn) mm	Function	Connection	Reference	Weight kg
12	NO	Pre-cabled (L = 2 m) (1)	<b>XS618B4MAL2</b>	0.120
		1/2"-20UNF connector	<b>XS618B4MAU20</b>	0.060
	NC	Pre-cabled (L = 2 m) (1)	<b>XS618B4MBL2</b>	0.120
		1/2"-20UNF connector	<b>XS618B4MBU20</b>	0.060

#### Ø 30, threaded M30 x 1.5

Sensing distance (Sn) mm	Function	Connection	Reference	Weight kg
22	NO	Pre-cabled (L = 2 m) (1)	<b>XS630B4MAL2</b>	0.205
		1/2"-20UNF connector	<b>XS630B4MAU20</b>	0.145
	NC	Pre-cabled (L = 2 m) (1)	<b>XS630B4MBL2</b>	0.205
		1/2"-20UNF connector	<b>XS630B4MBU20</b>	0.145

### Accessories (2)

Description	For use with sensors	Reference	Weight kg
Fixing clamps	Ø 18	<b>XSZB118</b>	0.010
	Ø 30	<b>XSZB130</b>	0.020

(1) For a 5 m long cable replace L2 by L5; for a 10 m long cable replace L2 by L10.

Example: XS618B4MAL2 becomes **XS618B4MAL5** with a 5 m long cable.

(2) For further information, see page 128.

Characteristics		XS6●●B4M●U20	XS6●●B4M●L2
Sensor type			
Product certifications		UL, CSA, CE	
Connection	Connector	1/2"-20UNF	
	Pre-cabled	-	
Operating zone	∅ 18	mm	0...9.6
	∅ 30	mm	0...17.6
Differential travel		%	
		1...15 of effective sensing distance (Sr)	
Degree of protection	Conforming to IEC 60529	IP 65 and IP 67	IP 65 and IP 68, double insulation
Storage temperature		°C	
		- 40...+ 85	
Operating temperature		°C	
		- 25...+ 70	
Materials	Case	Nickel plated brass	
	Sensing face	PPS	
	Cable	-	PvR 2 x 0.34 mm <sup>2</sup>
Vibration resistance	Conforming to IEC 60068-2-6	25 gn, amplitude ± 2 mm (f = 10 to 55 Hz)	
Shock resistance	Conforming to IEC 60068-2-27	50 gn, duration 11 ms	
Output state indication		Yellow LED: 4 viewing ports at 90°	Yellow LED: annular
Rated supply voltage		V	~ or --- 24...240 (~ 50/60 Hz)
Voltage limits (including ripple)		V	~ or --- 20...264
Switching capacity		mA	~ 5...300 or --- 5...200 (1)
Voltage drop, closed state		V	≤ 5.5
Residual current, open state		mA	≤ 0.8
Maximum switching frequency	XS618B4M●●●	Hz	~ 25 or --- 1000
	XS630B4M●●●	Hz	~ 25 or --- 300
Delays	First-up	ms	≤ 30 XS618B4M●●● and XS630B4M●●●
	Response	ms	≤ 0.5
	Recovery	ms	≤ 0.5 XS618B4M●●●, ≤ 2 XS630B4M●●●

(1) It is essential to connect a 0.4 A "quick-blow" fuse in series with the load.

## Wiring schemes

Connector	Pre-cabled	2-wire ~ or --- NO or NC output
1/2"-20UNF 	BU: Blue BN: Brown	
		⚡: on connector models only

## Setting-up

**Minimum mounting distances (mm)**

	Side by side	Face to face	Facing a metal object
∅ 18	e ≥ 72	e ≥ 144	e ≥ 36
∅ 30	e ≥ 120	e ≥ 264	e ≥ 66

## Dimensions

	Pre-cabled (mm)			Connector (mm)		
XS6	a	b	c	a	b	c
∅ 18	60	44	8	72	44	8
∅ 30	63	41	13	74	41	13

(1) LED



# Inductive proximity sensors

OsiSense XS, general purpose, standard range

Flat format, flush mountable

Two-wire DC

Three-wire DC, solid-state output

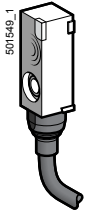

XS7J1A1●●L2

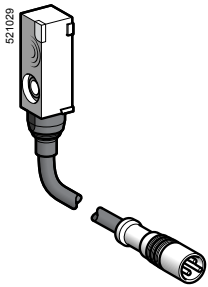

XS7J1A1●●L01M8

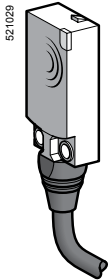

XS7F1A1●●L2

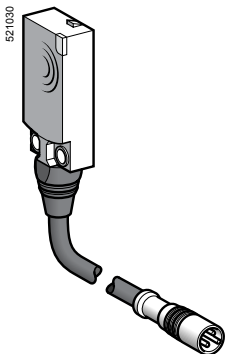

XS7F1A1●●L01M8

### Flat, 8 x 22 x 8 mm format (1) (2)

#### Three-wire ---

Sensing distance (Sn) mm	Function	Output	Connection	Reference	Weight kg
2.5	NO	PNP	Pre-cabled (L = 2 m) (3)	<b>XS7J1A1PAL2</b>	0.060
			Remote M8 connector on 0.15 m flying lead	<b>XS7J1A1PAL01M8</b>	0.040
	NPN	PNP	Pre-cabled (L = 2 m) (3)	<b>XS7J1A1NAL2</b>	0.060
			Remote M8 connector on 0.15 m flying lead	<b>XS7J1A1NAL01M8</b>	0.040
	NC	PNP	Pre-cabled (L = 2 m) (3)	<b>XS7J1A1PBL2</b>	0.060
			Remote M8 connector on 0.15 m flying lead	<b>XS7J1A1PBL01M8</b>	0.040
NPN	PNP	Pre-cabled (L = 2 m) (3)	<b>XS7J1A1NBL2</b>	0.060	
		Remote M8 connector on 0.15 m flying lead	<b>XS7J1A1NBL01M8</b>	0.040	

#### Two-wire ---

Sensing distance (Sn) mm	Function	Output	Connection	Reference	Weight kg
2.5	NO		Pre-cabled (L = 2 m) (3)	<b>XS7J1A1DAL2</b>	0.050
			Remote M8 connector on 0.15 m flying lead	<b>XS7J1A1DAL01M8</b>	0.035
NC			Pre-cabled (L = 2 m) (3)	<b>XS7J1A1DBL2</b>	0.050
			Remote M8 connector on 0.15 m flying lead	<b>XS7J1A1DBL01M8</b>	0.035

### Flat, 15 x 32 x 8 mm format (1)

#### Three-wire ---

Sensing distance (Sn) mm	Function	Output	Connection	Reference	Weight kg
5	NO	PNP	Pre-cabled (L = 2 m) (3)	<b>XS7F1A1PAL2</b>	0.065
			Remote M8 connector on 0.15 m flying lead	<b>XS7F1A1PAL01M8</b>	0.045
	NPN	PNP	Pre-cabled (L = 2 m) (3)	<b>XS7F1A1NAL2</b>	0.065
			Remote M8 connector on 0.15 m flying lead	<b>XS7F1A1NAL01M8</b>	0.045
	NC	PNP	Pre-cabled (L = 2 m) (3)	<b>XS7F1A1PBL2</b>	0.065
			Remote M8 connector on 0.15 m flying lead	<b>XS7F1A1PBL01M8</b>	0.045
NPN	PNP	Pre-cabled (L = 2 m) (3)	<b>XS7F1A1NBL2</b>	0.065	
		Remote M8 connector on 0.15 m flying lead	<b>XS7F1A1NBL01M8</b>	0.045	

#### Two-wire ---

Sensing distance (Sn) mm	Function	Output	Connection	Reference	Weight kg
5	NO		Pre-cabled (L = 2 m) (3)	<b>XS7F1A1DAL2</b>	0.055
			Remote M8 connector on 0.15 m flying lead	<b>XS7F1A1DAL01M8</b>	0.045
NC			Pre-cabled (L = 2 m) (3)	<b>XS7F1A1DBL2</b>	0.055
			Remote M8 connector on 0.15 m flying lead	<b>XS7F1A1DBL01M8</b>	0.045

(1) For accessories, see page 128.

(2) Sensors **XS7J** include a fixing clamp with screw.

(3) For a 5 m long cable replace L2 by L5; for a 10 m long cable replace L2 by L10.

Example: **XS7J1A1PAL2** becomes **XS7J1A1PAL5** with a 5 m long cable.

# Inductive proximity sensors

OsiSense XS, general purpose, standard range

Flat format, flush mountable

Two-wire DC

Three-wire DC, solid-state output

Characteristics		XS7J●●●●●L01M8	XS7F●●●●●L01M8	XS7J●●●●●L2, XS7F●●●●●L2
Sensor type		CE	UL, CSA, CE	
Product certifications				
Connection	Connector	Remote M8 connector on 0.15 m flying lead		–
	Pre-cabled	–		Length: 2 m
Operating zone	XS7J	mm	0...2	
	XS7F	mm	0...4	
Differential travel		%	1...15 of effective sensing distance (Sr)	
Degree of protection	Conforming to IEC 60529		IP 67 (XS7J), IP 68 (XS7F)	
Storage temperature		°C	- 40...+ 85	
Operating temperature		°C	- 25...+ 70	
Materials	Case		PBT	
	Cable		PvR 3 x 0.11 mm <sup>2</sup> or 2 x 0.11 mm <sup>2</sup> (XS7F: 2 or 3 x 0.34 mm <sup>2</sup> )	
Vibration resistance	Conforming to IEC 60068-2-6		25 gn, amplitude ± 2 mm (f = 10 to 55 Hz)	
Shock resistance	Conforming to IEC 60068-2-27		50 gn, duration 11 ms	
Output state indication			Yellow LED	
Rated supply voltage		V	--- 12...24 with protection against reverse polarity	
Voltage limits (including ripple)		V	--- 10...36	
Current consumption, no-load	3-wire	mA	≤ 10	
Residual current, open state	2-wire	mA	≤ 0.5	
Switching capacity	3-wire	mA	100 with overload and short-circuit protection	
	2-wire	mA	1.5...100 with overload and short-circuit protection	
Voltage drop, closed state	3-wire	V	≤ 2	
	2-wire	V	≤ 4	
Maximum switching frequency	3-wire	kHz	2	
	2-wire	kHz	4 for XS7J, 5 for XS7F	
Delays	First-up	ms	Three-wire: 5	
		ms	Two-wire: 10 XS7J, 5 XS7F	
	Response	ms	Three-wire: 0,1	
		ms	Two-wire: 0,5 XS7J, 5 XS7F	
	Recovery	ms	Three-wire: 0,1	
	ms	Two-wire: 1 XS7J, 5 XS7F		

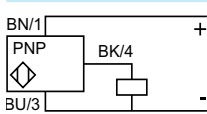
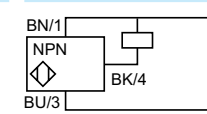
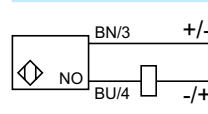
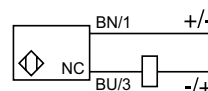
Connector	Pre-cabled	PNP NO or NC	NPN NO or NC	2-wire NO	2-wire NC
M8 	BU: Blue BN: Brown BK: Black				

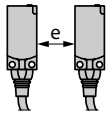
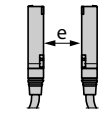
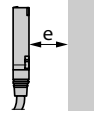
Setting-up	Minimum mounting distances (mm)		
			
	<b>Side by side</b>	<b>Face to face</b>	<b>Facing a metal object</b>
XS7J	e ≥ 1	e ≥ 6	e ≥ 7.5
XS7F	e ≥ 1	e ≥ 12	e ≥ 15

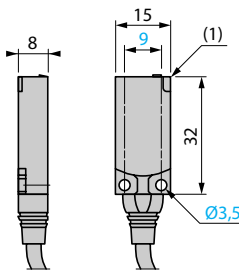
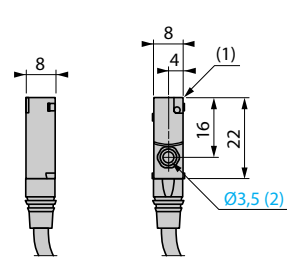
Dimensions	XS7F	XS7J
		
		(1) LED (2) For CHC type screws

# Inductive proximity sensors

OsiSense XS, general purpose, standard range

Flat format, flush mountable

Two-wire DC

Three-wire DC, solid-state output

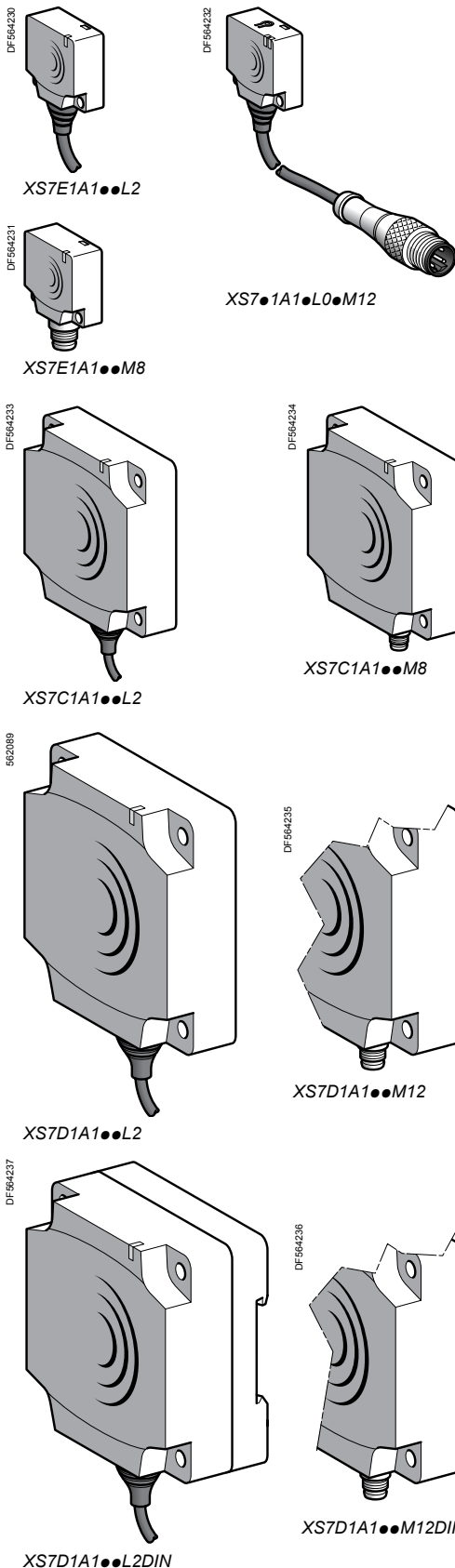

Sens. dist. (Sn) mm	Function	Output	Connection	Reference	Weight kg	
<b>Flat, 26 x 26 x 13 mm format (1)</b>						
<b>Three-wire ---</b>						
10	NO	PNP	Pre-cabled (L = 2 m) (4)	<b>XS7E1A1PAL2</b>	0.075	
			M8 connector	<b>XS7E1A1PAM8</b>	0.040	
			Remote M12 connector	<b>XS7E1A1PAL01M12</b>	0.040	
		NPN	Pre-cabled (L = 2 m) (4)	<b>XS7E1A1NAL2</b>	0.075	
			M8 connector	<b>XS7E1A1NAM8</b>	0.075	
			Remote M12 connector	<b>XS7E1A1NAL01M12</b>	0.040	
	NC	PNP	Pre-cabled (L = 2 m) (4)	<b>XS7E1A1PBL2</b>	0.075	
			M8 connector	<b>XS7E1A1PBM8</b>	0.040	
			Remote M12 connector	<b>XS7E1A1PBL01M12</b>	0.040	
		NPN	Pre-cabled (L = 2 m) (4)	<b>XS7E1A1NBL2</b>	0.075	
			M8 connector	<b>XS7E1A1NBM8</b>	0.040	
			Remote M12 connector	<b>XS7E1A1NBL01M12</b>	0.040	
<b>Two-wire ---</b>						
10	NO		Pre-cabled (L = 2 m) (4)	<b>XS7E1A1DAL2</b>	0.070	
			M8 connector	<b>XS7E1A1DAM8</b>	0.040	
			Remote M12 connector	<b>XS7E1A1DAL01M12</b>	0.040	
		NO terminals 1 and 4 (2)	Remote M12 connector	<b>XS7E1A1CAL01M12</b>	0.040	
			Remote M12 connector (3)	<b>XS7E1A1CAL08M12</b>	0.065	
			NC	PNP	Pre-cabled (L = 2 m) (4)	<b>XS7E1A1DBL2</b>
	M8 connector	<b>XS7E1A1DBM8</b>			0.040	
	Remote M12 connector	<b>XS7E1A1DBL01M12</b>			0.040	
	NPN	Pre-cabled (L = 2 m) (4)		<b>XS7E1A1NBL2</b>	0.070	
		M8 connector		<b>XS7E1A1NBM8</b>	0.040	
		Remote M12 connector		<b>XS7E1A1NBL01M12</b>	0.040	
	<b>Flat, 40 x 40 x 15 mm format (1)</b>					
<b>Three-wire ---</b>						
15	NO	PNP	Pre-cabled (L = 2 m) (4)	<b>XS7C1A1PAL2</b>	0.095	
			M8 connector	<b>XS7C1A1PAM8</b>	0.060	
			Remote M12 connector	<b>XS7C1A1PAL01M12</b>	0.060	
		NPN	Pre-cabled (L = 2 m) (4)	<b>XS7C1A1NAL2</b>	0.095	
			M8 connector	<b>XS7C1A1NAM8</b>	0.060	
			Remote M12 connector	<b>XS7C1A1NAL01M12</b>	0.060	
	NC	PNP	Pre-cabled (L = 2 m) (4)	<b>XS7C1A1PBL2</b>	0.095	
			M8 connector	<b>XS7C1A1PBM8</b>	0.060	
			Remote M12 connector	<b>XS7C1A1PBL01M12</b>	0.060	
		NPN	Pre-cabled (L = 2 m) (4)	<b>XS7C1A1NBL2</b>	0.095	
			M8 connector	<b>XS7C1A1NBM8</b>	0.060	
			Remote M12 connector	<b>XS7C1A1NBL01M12</b>	0.060	
	<b>Two-wire ---</b>					
	15	NO		Pre-cabled (L = 2 m) (4)	<b>XS7C1A1DAL2</b>	0.090
				M8 connector	<b>XS7C1A1DAM8</b>	0.060
				Remote M12 connector	<b>XS7C1A1DAL01M12</b>	0.060
			NO terminals 1 and 4 (2)	Remote M12 connector	<b>XS7C1A1CAL01M12</b>	0.060
				Remote M12 connector (3)	<b>XS7C1A1CAL08M12</b>	0.090
NC				PNP	Pre-cabled (L = 2 m) (4)	<b>XS7C1A1DBL2</b>
		M8 connector	<b>XS7C1A1DBM8</b>		0.060	
		Remote M12 connector	<b>XS7C1A1DBL01M12</b>		0.060	
		NPN	Pre-cabled (L = 2 m) (4)	<b>XS7C1A1NBL2</b>	0.090	
			M8 connector	<b>XS7C1A1NBM8</b>	0.060	
			Remote M12 connector	<b>XS7C1A1NBL01M12</b>	0.060	
<b>Flat, 80 x 80 x 26 mm format (1)</b>						
<b>Three-wire ---</b>						
40	NO	PNP	Pre-cabled (L = 2 m) (4)	<b>XS7D1A1PAL2 (5)</b>	0.340	
			M12 connector	<b>XS7D1A1PAM12 (5)</b>	0.290	
			M12 connector	<b>XS7D1A1PAL01M12 (5)</b>	0.290	
		NPN	Pre-cabled (L = 2 m) (4)	<b>XS7D1A1NAL2 (5)</b>	0.340	
			M12 connector	<b>XS7D1A1NAM12 (5)</b>	0.290	
			M12 connector	<b>XS7D1A1NAL01M12 (5)</b>	0.290	
	NC	PNP	Pre-cabled (L = 2 m) (4)	<b>XS7D1A1PBL2 (5)</b>	0.340	
			M12 connector	<b>XS7D1A1PBM12 (5)</b>	0.290	
			M12 connector	<b>XS7D1A1PBL01M12 (5)</b>	0.290	
		NPN	Pre-cabled (L = 2 m) (4)	<b>XS7D1A1NBL2 (5)</b>	0.340	
			M12 connector	<b>XS7D1A1NBM12 (5)</b>	0.290	
			M12 connector	<b>XS7D1A1NBL01M12 (5)</b>	0.290	
<b>Two-wire ---</b>						
40	NO		Pre-cabled (L = 2 m) (4)	<b>XS7D1A1DAL2 (5)</b>	0.340	
			M12 connector	<b>XS7D1A1DAM12 (5)</b>	0.290	
			M12 connector	<b>XS7D1A1DAL01M12 (5)</b>	0.290	
	NO terminals 1 and 4 (2)	Remote M12 connector	<b>XS7D1A1CAL01M12 (5)</b>	0.290		
		Remote M12 connector (3)	<b>XS7D1A1CAL08M12 (5)</b>	0.340		
		NC	PNP	Pre-cabled (L = 2 m) (4)	<b>XS7D1A1DBL2 (5)</b>	0.340
M12 connector	<b>XS7D1A1DBM12 (5)</b>			0.290		
M12 connector	<b>XS7D1A1DBL01M12 (5)</b>			0.290		

(1) For accessories, see page 128.

(2) The NO output is connected to terminals 1 and 4 of the M12 connector.

(3) Remote connector on 0.8 m flying lead.

(4) For a 5 m long cable replace L2 by L5; for a 10 m long cable replace L2 by L10.

Example: **S7 J1A1PAL2** becomes **XS7J1A1PAL5** with a 5 m long cable.

(5) For clipping onto 35 mm omega rail or 80 x 80 x 40 mm format, add DIN to the end of the reference. Example: **XS7D1A1PAL2** becomes **XS7D1A1PAL2DIN**.

# Inductive proximity sensors

OsiSense XS, general purpose, standard range

Flat format, flush mountable

Two-wire DC

Three-wire DC, solid-state output

Characteristics			XS7E●●●●●M8, XS7C●●●●●M8, XS7D●●●●●M12	XS7E●●●●●L01M12, XS7C●●●●●L01M12	XS7E●●●●●L2, XS7C●●●●●L2, XS7D●●●●●L2
Sensor type					
Product certifications			UL, CSA, CE		
Connection	Connector		M8 except M12 on XS7D●●●●●M12	M12 on 0.15 m flying lead for XS7●●●●●L01M12	–
	Pre-cabled		–	–	Length: 2 m
Operating zone	XS7E	mm	0...8		
	XS7C	mm	0...12		
	XS7D	mm	0...32		
Differential travel		%	1...15 of effective sensing distance (Sr)		
Degree of protection	Conforming to IEC 60529		IP 67, double insulation □ (except for M8 connector: IP 67)		IP 68, □
Storage temperature		°C	-40...+85		
Operating temperature		°C	-25...+70		
Materials	Case		PBT		
	Cable		–	PvR 3 x 0.34 mm <sup>2</sup> or 2 x 0.34 mm <sup>2</sup>	
Vibration resistance		Conforming to IEC 60068-2-6	25 gn, amplitude ± 2 mm (f = 10 to 55 Hz)		
Shock resistance		Conforming to IEC 60068-2-27	50 gn, duration 11 ms		
Output state indication			Yellow LED		
Rated supply voltage		V	12...24 with protection against reverse polarity		
Voltage limits (including ripple)		V	10...36		
Current consumption, no-load		3-wire mA	≤ 10		
Residual current, open state		2-wire mA	≤ 0.5		
Switching capacity	3-wire	mA	≤ 100 with overload and short-circuit protection		
	2-wire	mA	1.5...100 with overload and short-circuit protection		
Voltage drop, closed state	3-wire	V	≤ 2		
	2-wire	V	≤ 4		
Maximum switching frequency	XS7E, XS7C	kHz	1		
	XS7D	Hz	100		
Delays	First-up	3-wire	ms 10 XS7E and XS7C, 30 XS7D		
		2-wire	ms 5 XS7E and XS7D, 10 XS7D		
	Response	3-wire	ms 2 XS7E and XS7C, 5 XS7D		
		2-wire	ms 0,3 XS7E and XS7D, 10 XS7D		
	Recovery	3-wire	ms 6 XS7E, 5 XS7C, 35 XS7D		
		2-wire	ms 0,7 XS7E and XS7D, 10 XS7D		

## Wiring schemes

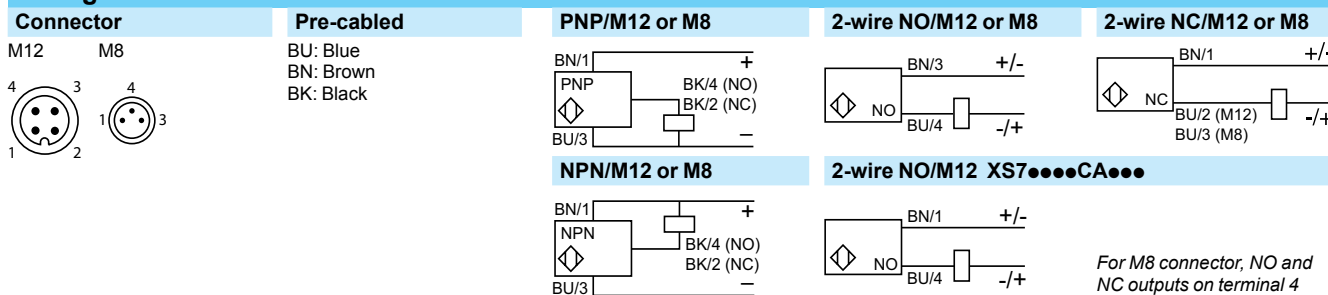

## Setting-up

Minimum mounting distances (mm)			XS7E	XS7C	XS7D
Side by side	e ≥		4	5	40
Face to face	e ≥		72	110	300
Facing a metal object	e ≥		30	45	120

## Dimensions

	XS7C/D/E	XS7C/D	XS7E				
Sensor	A (cable)	A (connector)	B	C	D	E	F
XS7E	14	11	26	13	8.8	20	3.5
XS7C	14	11	40	15	9.8	33	4.5
XS7D	23	18	80	26	16	65	5.5
XS7D●●DIN	23	18	80	40	30	65	5.1

(1) LED  
(2) For CHC type screws

# Inductive proximity sensors

OsiSense XS, general purpose  
Cubic case, 40 x 40 x 70 mm, M12 or 1/2"-20UNF  
connector  
5 position turret head

Sensor	Flush mountable in metal	Non flush mountable in metal
--------	--------------------------	------------------------------

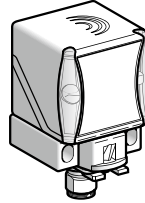

Nominal sensing distance (Sn)	15 mm	20 mm	40 mm
-------------------------------	-------	-------	-------

## References

4-wire ---	PNP NO+NC	–	XS8C2A1PCM12	XS8C2A4PCM12
	NPN NO+NC	–	XS8C2A1NCM12	XS8C2A4NCM12
3-wire ---	PNP NO	XS7C2A1PAM12	–	–
	NPN NO	XS7C2A1NAM12	–	–
	PNP NC	XS7C2A1PBM12	–	–
	NPN NC	XS7C2A1NBM12	–	–
2-wire ---	NO	XS7C2A1DAM12	XS8C2A1DAM12	XS8C2A4DAM12
	NC	XS7C2A1DBM12	XS8C2A1DBM12	XS8C2A4DBM12
2-wire (~/---) unprotected (1)	NO	XS7C2A1MAU20	XS8C2A1MAU20	XS8C2A4MAU20
	NC	XS7C2A1MBU20	XS8C2A1MBU20	XS8C2A4MBU20
Weight (kg)	0.149	0.149	0.149	

## Characteristics

Operating zone		0...12 mm	0...16 mm	0...32 mm
Product certifications		UL, CSA, CE, TÜV (4-wire versions)		
Conformity to standards		IEC 60947-5-2		
Conformity to safety standards (2)	For XS8C2A●PCM12	EN 62061 (2005): SILcl2 EN 61508 (2010): SIL 2, EN ISO 13849 (2008): PL d		
Reliability data (2)	For XS8C2A●PCM12	MTTFd = 1546 years PFHd = 7.4 10 <sup>-8</sup> 1/h		
Connection		M12 connector for --- versions 1/2"-20UNF connector for ~/--- versions		
Differential travel		3...15% of Sr		
Degree of protection	Conforming to IEC 60529 and DIN 40050	IP 65, IP 67 and IP 69K		
Temperature	Storage Operation (3)	- 40...+ 85°C - 25...+ 70°C		
Material		Case: PBT		
Vibration resistance	Conforming to IEC 60068-2-6	25 gn, amplitude ± 2 mm (f = 10...55 Hz)		
Shock resistance	Conforming to IEC 60068-2-27	50 gn for 11 ms		
Indicators	Output state Power on	Yellow LED Green LED, for 4-wire ---, 3-wire --- and 2-wire ~/--- versions		
Rated supply voltage	4-wire ---	12...48 V with protection against reverse polarity		
	3-wire ---	12...24 V with protection against reverse polarity		
	2-wire ---	12...48 V with protection against reverse polarity		
	2-wire ~/---	24...240 V (~ 50/60 Hz)		
Voltage limits (including ripple)	4-wire ---	10...58 V		
	3-wire ---	10...36 V		
	2-wire ---	10...58 V		
	2-wire ~/---	20...264 V		
Current consumption, no-load	3-wire and 4-wire ---	< 15 mA		
Residual current, open state	2-wire ---	< 0.6 mA		
	2-wire ~/---	1.5 mA		
Switching capacity	3-wire and 4-wire ---	< 200 mA with overload and short-circuit protection		
	2-wire ---	< 100 mA with overload and short-circuit protection		
	2-wire ~/---	~: 5...300 mA (1) ---: 5...200 mA (1)		
Voltage drop, closed state	3-wire and 4-wire ---	< 2 V		
	2-wire ---	< 4.2 V		
	2-wire ---/~	< 5.5 V		
Maximum switching frequency		Flush mountable: --- 300 Hz, ~ 25 Hz Non flush mountable: --- 150 Hz, ~ 25 Hz		
Delays	First-up	7 ms (3-wire and 4-wire ---), 20 ms (2-wire --- and 2-wire ---/~)		
	Response	Flush mountable: ≤ 1.2 ms. Non flush mountable: ≤ 1.4 ms		
	Recovery	Flush mountable: ≤ 1.8 ms. Non flush mountable: ≤ 3.5 ms		

(1) Sensor must be protected by a 0.4 A quick-blow fuse (reference XUZ E04) connected in series with the load (see page 128).

(2) SIL 2 protection can only be obtained by connecting both outputs to a safety PLC. Please refer to the "Safety solutions using Preventa" catalogue.

(3) Sensors are available for very low temperatures (suffix TF: - 40°C, + 70°C) or very high temperatures (suffix TT: - 25°C, + 85°C). Please consult our Customer Care Centre.

# Inductive proximity sensors

## OsiSense XS, general purpose

Cubic case, 40 x 40 x 70 mm, M12 or 1/2"-20UNF connector  
5 position turret head

### Setting-up precautions

#### Minimum mounting distances (mm)

		Side by side	Face to face	Facing a metal object
Sensors flush mountable in metal	<b>XS7C2A1●●</b>	$e \geq 60$	$e \geq 120$	$e \geq 45$
	<b>XS8C2A1●●</b>	$e \geq 80$	$e \geq 160$	$e \geq 60$
Sensors non flush mountable in metal	<b>XS8C2A4●●</b>	$e \geq 160$	$e \geq 320$	$e \geq 120$

### Wiring schemes

#### 4-wire ---, NO + NC outputs

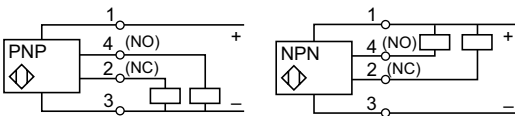

#### 2-wire ---, NO output (M12 connector)

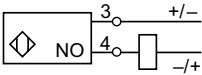

#### 2-wire ---, NC output (M12 connector)

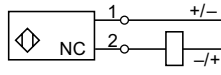

#### 3-wire, PNP

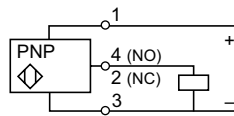

#### M12 connector

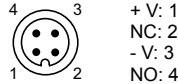

#### 3-wire, NPN

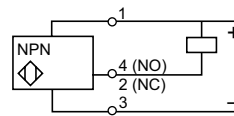

#### 1/2"-20UNF connector

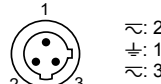

#### 2-wire, 1/2"-20UNF

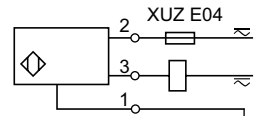

### Accessory references

Description	Type	Length m	Reference	Weight kg
<b>Pre-wired M12 connectors</b> Female, 4-pin, zinc die-cast, nickel plated clamping ring	Straight	2	<b>XZCP1141L2</b>	0.090
		5	<b>XZCP1141L5</b>	0.190
		10	<b>XZCP1141L10</b>	0.370
	Elbowed	2	<b>XZCP1241L2</b>	0.090
		5	<b>XZCP1241L5</b>	0.190
		10	<b>XZCP1241L10</b>	0.370
<b>Pre-wired 1/2"-20UNF connectors</b> Female, 3-pin, zinc die-cast, nickel plated clamping ring	Straight	5	<b>XZCP1865L5</b>	0.180
		10	<b>XZCP1865L10</b>	0.350
		10	<b>XZCP1965L10</b>	0.350
	Elbowed	5	<b>XZCP1965L5</b>	0.180
		10	<b>XZCP1965L10</b>	0.350

### Dimensions

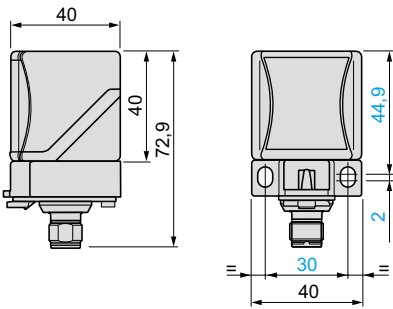

### Head positions

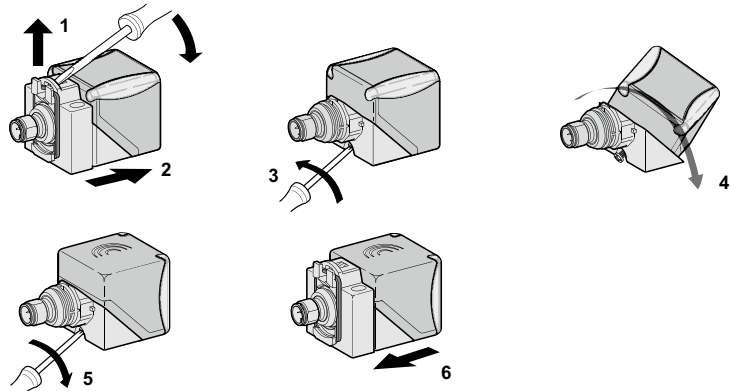

### Example SIL 2 wiring scheme (with Preventa XPS MF40 safety PLC)

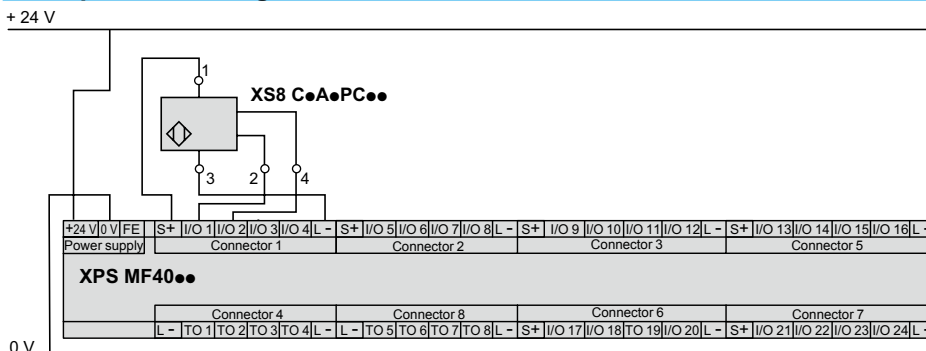

SFF (Safe Failure Fraction): 92,68 %  
DC (Diagnosis Coverage): 75,8 %

S+: 24 V  
L-: 0 V  
I/O 1...24: safety I/O



# Inductive proximity sensors

OsiSense XS, general purpose

Plastic case, 40 x 40 x 117 mm, plug-in

5 position turret head

Sensor	Flush mountable in metal	Non flush mountable in metal
--------	--------------------------	------------------------------

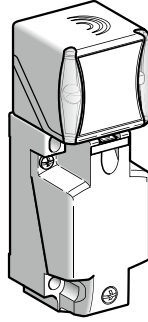

Nominal sensing distance (Sn)	15 mm	20 mm	40 mm
-------------------------------	-------	-------	-------

## References

4-wire $\overline{---}$	PNP NO+NC	–	<b>XS8C4A1PCP20</b>	<b>XS8C4A4PCP20</b>
	NPN NO+NC	–	<b>XS8C4A1NCP20</b>	<b>XS8C4A4NCP20</b>
2-wire $\overline{---}$	NO or NC programmable	<b>XS7C4A1DPP20</b>	<b>XS8C4A1DPP20</b>	<b>XS8C4A4DPP20</b>
2-wire ( $\sim/\overline{---}$ ) unprotected (1)	NO or NC programmable	<b>XS7C4A1MPP20</b>	<b>XS8C4A1MPP20</b>	<b>XS8C4A4MPP20</b>
Weight (kg)		0.244	0.244	0.244

*Note: These sensors have an M20 cable entry. They can also be supplied with a PG 13.5 cable entry (e.g. **XS8C4A4PCG13**) or a 1/2" NPT cable entry (e.g. **XS8C4A1MPN12**). Please consult our Customer Care Centre.*

## Characteristics

Operating zone		0...12 mm	0...16 mm	0...32 mm
Product certifications		UL, CSA, CE. TÜV (4-wire versions)		
Conformity to standards		IEC 60947-5-2		
Conformity to safety standards (2)	For XS8C4A●PCP20	EN 62061 (2005): SILcl2, EN 61508 (2010): SIL 2, EN ISO 13849 (2008): PL d		
Reliability data (2)	For XS8C4A●PCP20	MTTFd = 1546 years PFHd = 7.4 10 <sup>-8</sup> 1/h		
Connection		Screw terminals, clamping capacity: 2 or 4 x 1.5 mm <sup>2</sup> (3)		
Differential travel		3...15% of Sr		
Degree of protection	Conforming to IEC 60529 and DIN 40050	IP 65, IP 67 and IP 69K		
Temperature	Storage	-40...+85°C		
	Operation (4)	-25...+70°C		
Material		Case: PBT		
Vibration resistance	Conforming to IEC 60068-2-6	25 gn, amplitude ± 2 mm (f = 10...55 Hz)		
Shock resistance	Conforming to IEC 60068-2-27	50 gn for 11 ms		
Indicators	Output state	Yellow LED		
	Power on	Green LED, for 4-wire $\overline{---}$ and 2-wire $\sim/\overline{---}$ versions		
Rated supply voltage	4-wire $\overline{---}$	12...48 V with protection against reverse polarity		
	2-wire $\overline{---}$	12...48 V with protection against reverse polarity		
	2-wire $\sim/\overline{---}$	24...240 V ( $\sim$ 50/60 Hz)		
Voltage limits (including ripple)	4-wire $\overline{---}$	10...58 V		
	2-wire $\overline{---}$	10...58 V		
	2-wire $\sim/\overline{---}$	20...264 V		
Current consumption, no-load	4-wire $\overline{---}$	< 15 mA		
Residual current, open state	2-wire $\overline{---}$	< 0.6 mA		
	2-wire $\sim/\overline{---}$	1.5 mA		
Switching capacity	4-wire $\overline{---}$	< 200 mA with overload and short-circuit protection		
	2-wire $\overline{---}$	< 100 mA with overload and short-circuit protection		
	2-wire $\sim/\overline{---}$	$\sim$ : 5...300 mA (1) $\overline{---}$ : 5...200 mA (1)		
Voltage drop, closed state	4-wire $\overline{---}$	< 2 V		
	2-wire $\overline{---}$	< 4.2 V		
	2-wire $\overline{---}/\sim$	< 5.5 V		
Maximum switching frequency		Flush mountable: $\overline{---}$ 300 Hz, $\sim$ 25 Hz Non flush mountable: $\overline{---}$ 150 Hz, $\sim$ 25 Hz		
Delays	First-up	7 ms (3-wire and 4-wire $\overline{---}$ ), 20 ms (2-wire $\overline{---}$ and 2-wire $\overline{---}/\sim$ )		
	Response	Flush mountable: ≤ 1.2 ms. Non flush mountable: ≤ 1.4 ms		
	Recovery	Flush mountable: ≤ 1.8 ms. Non flush mountable: ≤ 3.5 ms		

(1) Sensor must be protected by a 0.4 A quick-blow fuse (reference **XUZ E04**) connected in series with the load (see page 128).

(2) SIL 2 protection can only be obtained by connecting both outputs to a safety PLC. Please refer to the "Safety solutions using Preventa" catalogue.

(3) These sensors are supplied without a cable gland. An adaptable PG 13.5 cable gland is available (reference **XSZ PE13**). Accessories are available for connection to an M12 or 7/8"-16UN connector which can be added to the PG 13.5 sensor. Please consult our Customer Care Centre.

(4) Sensors are available for very low temperatures (suffix **TF**: -40°C, +70°C) or very high temperatures (suffix **TT**: -25°C, +85°C). Please consult our Customer Care Centre.



# Inductive proximity sensors

OsiSense XS, general purpose  
Plastic case, 40 x 40 x 117 mm, plug-in  
5 position turret head

## Setting-up precautions

### Minimum mounting distances (mm)

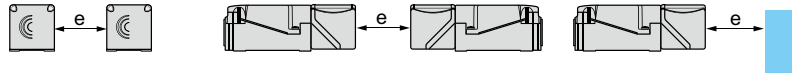

		Side by side	Face to face	Facing a metal object
Sensors flush mountable in metal	XS7C4A1●●	$e \geq 60$	$e \geq 120$	$e \geq 45$
	XS8C4A1●●	$e \geq 80$	$e \geq 160$	$e \geq 60$
Sensors non flush mountable in metal	XS8C4A4●●	$e \geq 160$	$e \geq 320$	$e \geq 120$

## Wiring schemes

### NO + NC outputs

#### 4-wire ...

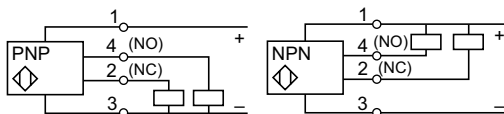

### NO or NC outputs, depending on position of link

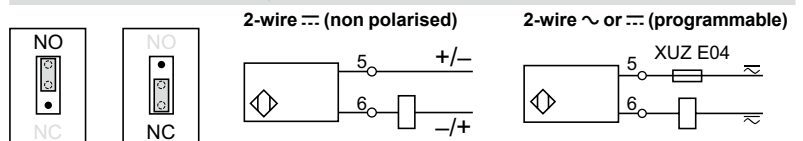

## Dimensions

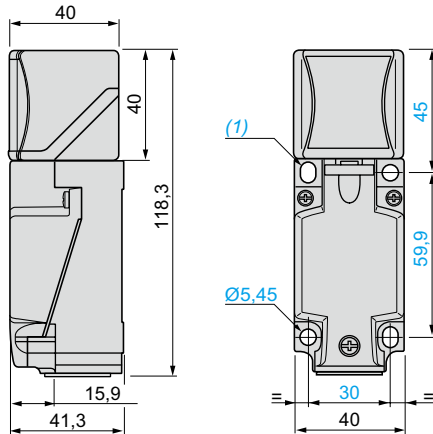

(1) 2 elongated holes  $\varnothing 5.3 \times 7$  cm.

Tightening torque of cover fixing screws and clamp screws:  $< 1.2$  Nm

## Head positions

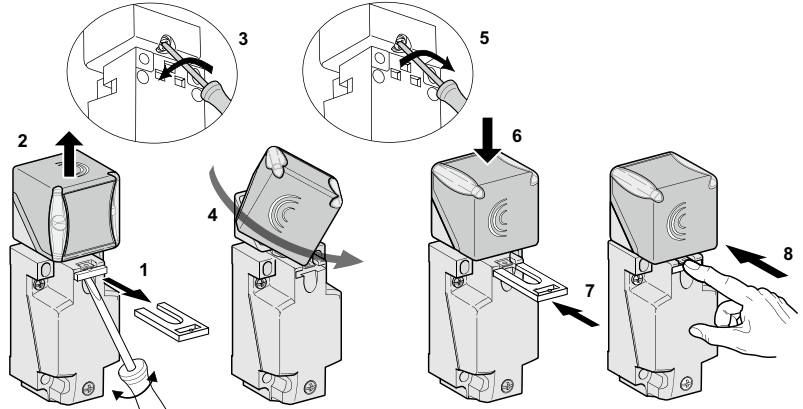

## Example SIL 2 wiring scheme (with Preventa XPS MF40 safety PLC)

+ 24 V

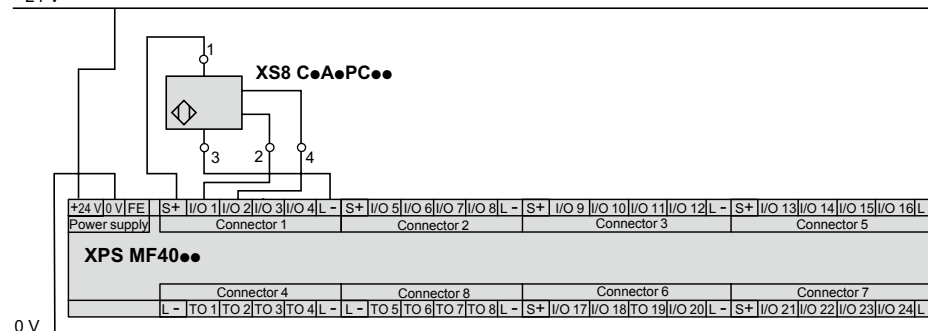

SFF (Safe Failure Fraction): 92,68 %  
DC (Diagnosis Coverage): 75,8 %

S+: 24 V  
L-: 0 V  
I/O 1...24: safety I/O

# Inductive proximity sensors

OsiSense XS, general purpose

Plastic case, 40 x 40 x 117 format, plug-in

5 position turret head

DC supply

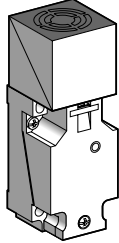
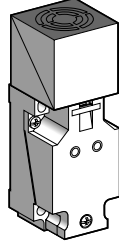
Sensor	Flush mountable in metal			Non flush mountable in metal			
							
Nominal sensing distance (Sn)	15 mm	Increased range 20 mm	15 mm	20 mm	Increased range 40 mm	20 mm	
<b>References</b>							
4-wire $\overline{\text{---}}$ (complementary outputs)	PNP NO + NC	<b>XS7C40PC440</b>	<b>XS7C40PC449</b>	–	<b>XS8C40PC440</b>	<b>XS8C40PC449</b>	–
	NPN NO + NC	<b>XS7C40NC440</b>	<b>XS7C40NC449</b>	–	<b>XS8C40NC440</b>	<b>XS8C40NC449</b>	–
2-wire $\overline{\text{---}}$ (non polarised)	NO	–	–	<b>XS7C40DA210</b>	–	–	<b>XS8C40DA210</b>
	NO or NC programmable	–	–	<b>XS7C40DP210</b>	–	–	<b>XS8C40DP210</b>
Weight (kg)	0.220	0.220	0.220	0.220	0.220	0.220	
<b>Characteristics</b>							
Product certifications	UL, CSA, CE						
Degree of protection conforming to IEC 60529	IP 67						
Operating temperature	- 25...+ 70 °C						
Connection	Screw terminals, clamping capacity: 2 or 4 x 1.5 mm <sup>2</sup> (1)						
Operating zone	<b>0...12 mm</b>	<b>0...16 mm</b>	<b>0...12 mm</b>	<b>0...16 mm</b>	<b>0...32 mm</b>	<b>0...16 mm</b>	
Repeat accuracy	≤ 3 % of effective sensing distance (Sr)						
Differential travel	3...20 % of effective sensing distance (Sr)						
Status indication	Output	Yellow LED		Yellow LED	Yellow LED	Yellow LED	
	Supply on	Green LED		–	Green LED	–	
Rated supply voltage	$\overline{\text{---}}$ 12...48 V with protection against reverse polarity						
Voltage limits (including ripple)	$\overline{\text{---}}$ 10...58 V						
Current consumption, no-load	≤ 10 mA		–	≤ 10 mA		–	
Switching capacity	0...200 mA		1.5...100 mA	0...200 mA		1.5...100 mA	
	With overload and short-circuit protection						
Residual current, open state	–		≤ 0.5 mA	–		≤ 0.5 mA	
Voltage drop, closed state	≤ 2 V		≤ 4 V	≤ 2 V		≤ 4 V	
Maximum switching frequency	1000 Hz		1500 Hz	1000 Hz	500 Hz	800 Hz	
Delays	First-up	≤ 5 ms		≤ 5 ms	≤ 5 ms	≤ 5 ms	
	Response	≤ 0.3 ms		≤ 2 ms	≤ 0.3 ms	< 1 ms	
	Recovery	≤ 0.7 ms		≤ 5 ms	≤ 0.7 ms	< 1 ms	

(1) Cable gland not included with sensor. For suitable 13P cable gland (XSZPE13), see page 128.

# Inductive proximity sensors

OsiSense XS, general purpose

Plastic case, 40 x 40 x 117 format, plug-in

5 position turret head

DC supply

## Dimensions

XS7C40D●210, XS8C40D●210

XS7C40●C44●, XS8C40●C44●

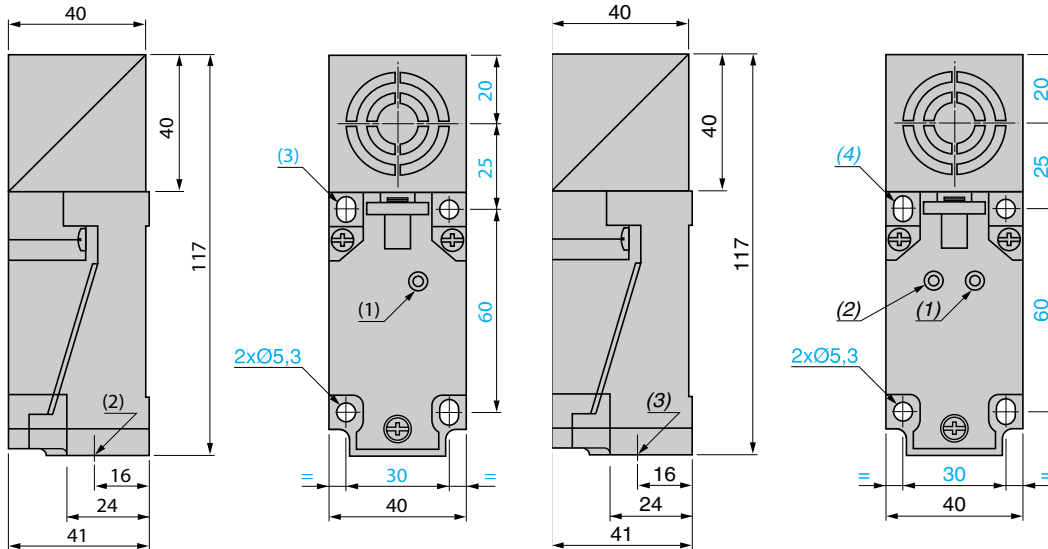

- (1) Output LED.
- (2) 1 tapped entry for 13P cable gland.
- (3) 2 elongated holes  $\text{Ø} 5.3 \times 7$ .

- (1) Output LED.
- (2) Supply LED.
- (3) 1 tapped entry for 13P cable gland.
- (4) 2 elongated holes  $\text{Ø} 5.3 \times 7$ .

## Setting-up

### Minimum mounting distances (mm)

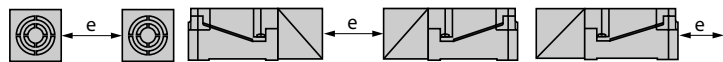

		Side by side	Face to face	Facing a metal object
Sensors flush mountable in metal	XS7	$e \geq 40$	$e \geq 120$	$e \geq 45$
	XS7 increased range model	$e \geq 80$	$e \geq 240$	$e \geq 60$
Sensors non flush mountable in metal	XS8	$e \geq 80$	$e \geq 160$	$e \geq 60$
	XS8 increased range model	$e \geq 160$	$e \geq 320$	$e \geq 120$

Tightening torque of cover fixing screws and clamp screws:  $< 1.2 \text{ N.m}$

## Wiring schemes

2-wire  $\text{---}$  (non polarised), NO or NC output depending on position of link

4-wire  $\text{---}$ , NO + NC output

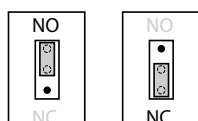
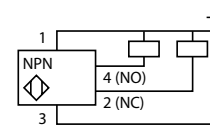
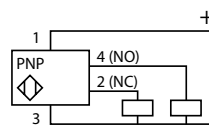
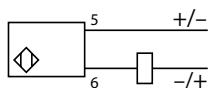

# Inductive proximity sensors

OsiSense XS, general purpose

Plastic case, 40 x 40 x 117 format, plug-in

5 position turret head

AC or DC supply

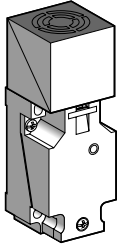
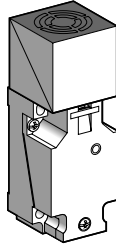
Sensor		Flush mountable in metal		Non flush mountable in metal	
					
		AC	AC/DC	AC	AC/DC
Nominal sensing distance (Sn)		15 mm		20 mm	
<b>References</b>					
2-wire ~	NO or NC programmable	<b>XS7C40FP260</b>	–	<b>XS8C40FP260</b>	–
2-wire ~ or ≡ universal model	NO or NC programmable	–	<b>XS7C40MP230</b>	–	<b>XS8C40MP230</b>
Weight (kg)		0.220	0.220	0.220	0.220
<b>Characteristics</b>					
Product certifications		UL, CSA, CE			
Degree of protection conforming to IEC 60529		IP 67			
Operating temperature		-25...+70 °C			
Connection		Screw terminals, clamping capacity 2 x 1.5 mm <sup>2</sup> (1)			
Operating zone		0...12 mm		0...16 mm	
Repeat accuracy		≤ 3 % of effective sensing distance (Sr)			
Differential travel		3...20 % of effective sensing distance (Sr)			
Output state indication		Yellow LED			
Rated supply voltage with protection against reverse polarity		~ 24...240 V, 50/60 Hz	~ 24...240 V, 50/60 Hz or ≡ 24...210 V	~ 24...240 V, 50/60 Hz	~ 24...240 V, 50/60 Hz or ≡ 24...210 V
Voltage limits (including ripple)		~ 20...264 V	~ or ≡ 20...264 V	~ 20...264 V	~ or ≡ 20...264 V
Current consumption, no-load		–			
Switching capacity		5...500 mA (2) (2A inrush)	~ 5...300 mA or ≡ 5...200 mA (2)	5...500 mA (2) (2A inrush)	~ 5...300 mA or ≡ 5...200 mA (2)
Residual current, open state		≤ 1.5 mA	0.8 mA on 24 V 1.5 mA on 120 V	≤ 1.5 mA	0.8 mA on 24 V 1.5 mA on 120 V
Voltage drop, closed state		≤ 5.5 V			
Maximum switching frequency		25 Hz	~ 25 Hz, ≡ 50 Hz	25 Hz	~ 25 Hz, ≡ 50 Hz
Delays					
	First-up	≤ 120 ms			
	Response	≤ 30 ms			
	Recovery	≤ 20 ms			

(1) Cable gland not included with sensor. For suitable 13P cable gland (XSZPE13), see page 128.

(2) These sensors do not incorporate overload or short-circuit protection and therefore, it is essential to connect a "quick-blow" fuse in series with the load, see page 128.

# Inductive proximity sensors

OsiSense XS, general purpose

Plastic case, 40 x 40 x 117 format, plug-in

5 position turret head

AC or DC supply

## Dimensions

XS7C40FP260, XS7C40MP230, XS8C40FP260, XS8C40MP230

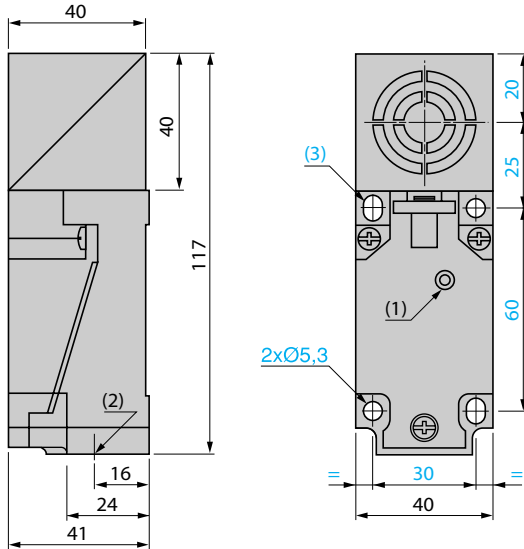

(1) Output LED.

(2) 1 tapped entry for 13P cable gland.

(3) 2 elongated holes  $\varnothing 5.3 \times 7$ .

## Setting-up

Minimum mounting distances (mm)

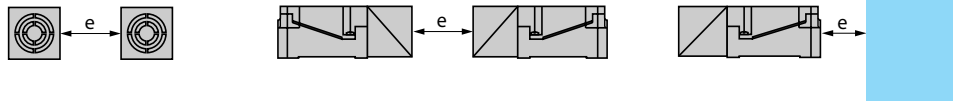

	Side by side	Face to face	Facing a metal object
XS7 flush mountable	$e \geq 40$	$e \geq 120$	$e \geq 45$
XS8 non flush mountable	$e \geq 80$	$e \geq 160$	$e \geq 60$

Tightening torque of cover fixing screws and clamp screws:  $< 1.2 \text{ N.m}$

## Wiring schemes

2-wire  $\sim$  programmable, NO or NC output depending on position of link

2-wire  $\sim$  or  $\text{---}$  programmable, NO or NC output depending on position of link

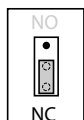
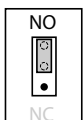
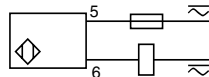
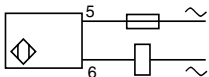

# Inductive proximity sensors

## OsiSense XS Application

For conveying and material handling applications  
Plastic case, cubic 40 form, multiposition  
DC supply

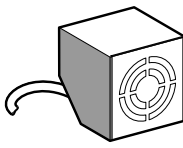
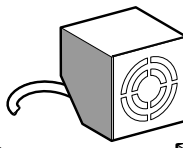
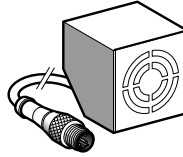
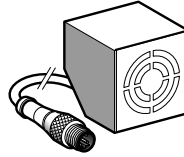
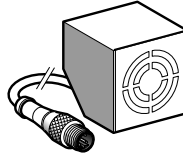
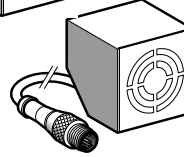
Sensor	Flush mountable in metal	Non flush mountable in metal
		
		
		
Nominal sensing distance (Sn)	15 mm	20 mm

References							
2-wire $\overline{---}$ (non polarised)	NO	<b>XS7T4DA210</b>	–	<b>XS7T4DA214LD</b>	–	<b>XS7T4DA214LD01</b>	–
4-wire $\overline{---}$ (complementary outputs)	PNP NO + NC	–	<b>XS7T4PC440</b>	–	<b>XS7T4PC440LD</b>	–	<b>XS8T4PC440</b> <b>XS8T4PC440LD</b>
	NPN NO + NC	–	<b>XS7T4NC440</b>	–	<b>XS7T4NC440LD</b>	–	<b>XS8T4NC440</b> <b>XS8T4NC440LD</b>
Weight (kg)		0.265	0.265	0.220	0.220	0.200	0.265 0.220

Characteristics							
Product certifications		UL, CSA, CE					
Degree of protection Conforming to IEC 60529		IP 67					
Operating temperature		-25...+70 °C					
Connection	Pre-cabled	2 x 0.5 mm <sup>2</sup> length 2 m (1)	4 x 0.34 mm <sup>2</sup> length 2 m (1)	–	–	4 x 0.34 mm <sup>2</sup> length 2 m (1)	–
	Connector Remote M12	–	–	0.8 m flying lead	–	0.15 m flying lead	– 0.8 m flying lead
Operating zone		<b>0...12 mm</b>				<b>0...16 mm</b>	
Repeat accuracy		≤ 3 % of Sr (effective sensing distance)					
Differential travel		3...20 % of Sr (effective sensing distance)					
Output state indication		Yellow LED, on rear					
Rated supply voltage		$\overline{---}$ 12...48 V with protection against reverse polarity					
Voltage limits (including ripple)		$\overline{---}$ 10...58 V					
Current consumption, no-load		–	≤ 10 mA	–	≤ 10 mA	–	≤ 10 mA
Switching capacity		1.5...100 mA	0...200 mA	1.5...100 mA	0...200 mA	1.5...100 mA	0...200 mA
Residual current, open state		With overload and short-circuit protection					
		≤ 0.7 mA	≤ 0.1 mA	≤ 0.7 mA	≤ 0.1 mA	≤ 0.7 mA	≤ 0.1 mA
Voltage drop, closed state		≤ 5.2 V	≤ 2 V	≤ 5.2 V	≤ 2 V	≤ 5.2 V	≤ 2 V
Maximum switching frequency		150 Hz	1000 Hz	150 Hz	1000 Hz	150 Hz	1000 Hz
Delays	First-up	≤ 5 ms	≤ 7 ms	≤ 5 ms	≤ 7 ms	≤ 5 ms	≤ 7 ms
	Response	≤ 2 ms	≤ 0.3 ms	≤ 2 ms	≤ 0.3 ms	≤ 2 ms	≤ 0.3 ms
	Recovery	≤ 5 ms	≤ 0.7 ms	≤ 5 ms	≤ 0.7 ms	≤ 5 ms	≤ 0.7 ms

(1) Sensors available with other cable lengths:

Length of cable	Suffix to be added to references stated above for 2 m pre-cabled sensors	Weight increase
5 m	L1	0.120 kg
10 m	L2	0.320 kg

Example: sensor **XS7T4DA210** with 5 m cable becomes **XS7T4DA210L1**

**Other versions** Sensors specifically designed for other operating temperatures. Please consult our Customer Care Centre.

# Inductive proximity sensors

OsiSense XS Application

For conveying and material handling applications

Plastic case, cubic 40 form, multiposition

DC supply

## Dimensions

XS7T4●●●●●, XS7T4●●●●●LD, XS7T4●●●●●LD01

Plate mounted

Bracket mounted

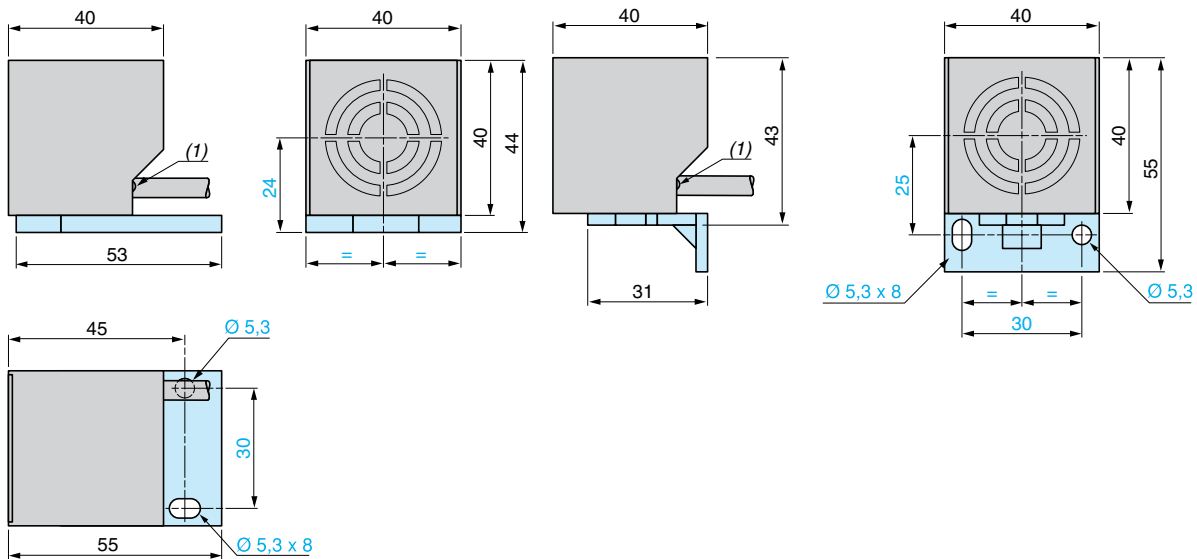

(1) LED.

## Alternative positions of head

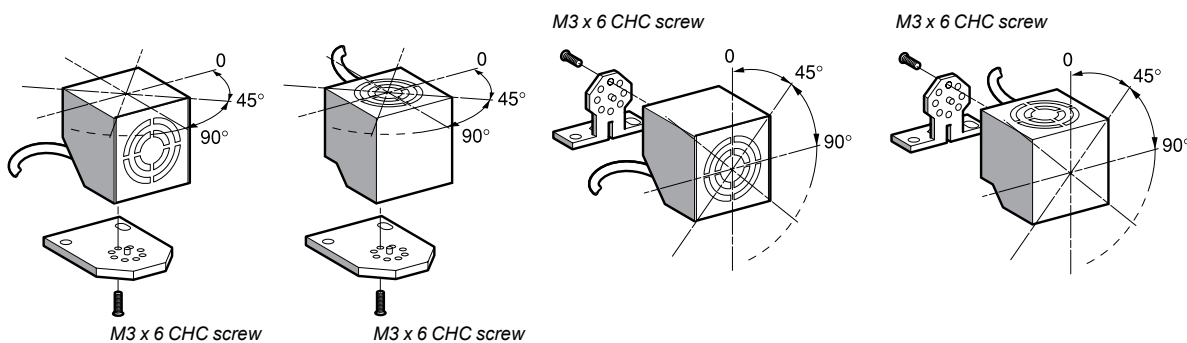

## Setting-up

Minimum mounting distances (mm)

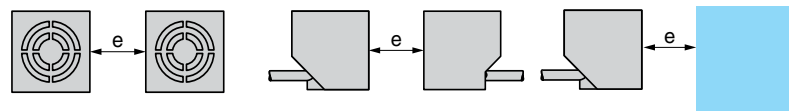

		Side by side	Face to face	Facing a metal object
Sensors flush mountable in metal	XS7T, 2-wire	$e \geq 40$	$e \geq 120$	$e \geq 45$
	XS7T, 4-wire	$e \geq 40$	$e \geq 120$	$e \geq 45$
Sensors non flush mountable in metal	XS8T, 4-wire	$e \geq 60$	$e \geq 160$	$e \geq 60$

## Wiring schemes

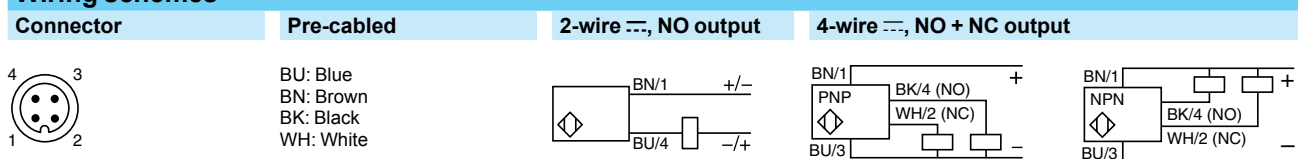



# Inductive proximity sensors

OsiSense XS, general purpose

Multivoltage sensor, cylindrical, flush mountable and non flush mountable

Two-wire AC or DC, short-circuit protection

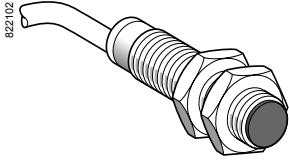

XS1M●●●●250

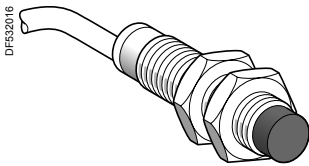

XS2M●●●●250

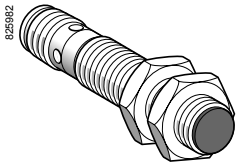

XS1M●●●●250K

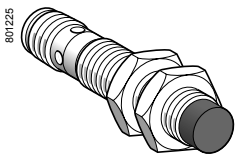

XS2M●●●●250K

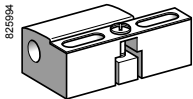

XSZB1●●

Sensing distance (Sn) mm	Function	Connection	Reference	Weight kg
--------------------------	----------	------------	-----------	-----------

### Ø 12, threaded M12 x 1

#### Flush mountable

2	NO	Pre-cabled (L = 2 m) (1)	<b>XS1M12MA250</b>	0.075
		1/2"-20UNF connector	<b>XS1M12MA250K</b>	0.025
	NC	Pre-cabled (L = 2 m) (1)	<b>XS1M12MB250</b>	0.075
		1/2"-20UNF connector	<b>XS1M12MB250K</b>	0.025

#### Non flush mountable

4	NO	Pre-cabled (L = 2 m) (1)	<b>XS2M12MA250</b>	0.075
		1/2"-20UNF connector	<b>XS2M12MA250K</b>	0.025
	NC	Pre-cabled (L = 2 m) (1)	<b>XS2M12MB250</b>	0.075

### Ø 18, threaded M18 x 1

#### Flush mountable

5	NO	Pre-cabled (L = 2 m) (1)	<b>XS1M18MA250</b>	0.120
		1/2"-20UNF connector	<b>XS1M18MA250K</b>	0.060
	NC	Pre-cabled (L = 2 m) (1)	<b>XS1M18MB250</b>	0.120
		1/2"-20UNF connector	<b>XS1M18MB250K</b>	0.060

#### Non flush mountable

8	NO	Pre-cabled (L = 2 m) (1)	<b>XS2M18MA250</b>	0.120
		1/2"-20UNF connector	<b>XS2M18MA250K</b>	0.060
	NC	Pre-cabled (L = 2 m) (1)	<b>XS2M18MB250</b>	0.120
		1/2"-20UNF connector	<b>XS2M18MB250K</b>	0.060

### Ø 30, threaded M30 x 1.5

#### Flush mountable

10	NO	Pre-cabled (L = 2 m) (1)	<b>XS1M30MA250</b>	0.205
		1/2"-20UNF connector	<b>XS1M30MA250K</b>	0.145
	NC	Pre-cabled (L = 2 m) (1)	<b>XS1M30MB250</b>	0.205
		1/2"-20UNF connector	<b>XS1M30MB250K</b>	0.145

#### Non flush mountable

15	NO	Pre-cabled (L = 2 m) (1)	<b>XS2M30MA250</b>	0.205
		1/2"-20UNF connector	<b>XS2M30MA250K</b>	0.145
	NC	Pre-cabled (L = 2 m) (1)	<b>XS2M30MB250</b>	0.205
		1/2"-20UNF connector	<b>XS2M30MB250K</b>	0.145

### Accessories (2)

Description mm		Reference	Weight kg
Fixing clamps	Ø 12	<b>XSZB112</b>	0.006
	Ø 18	<b>XSZB118</b>	0.010
	Ø 30	<b>XSZB130</b>	0.020

(1) For a 5 m long cable add L1 to the reference; for a 10 m long cable add L2 to the reference.

Example: **XS1M18MA250** becomes **XS1M18MA250L1** with a 5 m long cable.

(2) For further information, see page 128.

# Inductive proximity sensors

OsiSense XS, general purpose

Multivoltage sensor, cylindrical, flush mountable and non flush mountable

Two-wire AC or DC, short-circuit protection

Characteristics		XS●M●●M●250K	XS●M●●M●250
Sensor type		UL, CSA, CE	
Product certifications			
Connection		1/2"-20UNF connector	Pre-cabled, length: 2 m
Operating zone	Ø 12 flush mountable	mm	0...1.6
	Ø 12 non flush mountable	mm	0...3.2
	Ø 18 flush mountable	mm	0...4
	Ø 18 non flush mountable	mm	0...6.4
	Ø 30 flush mountable	mm	0...8
	Ø 30 non flush mountable	mm	0...12
Differential travel		%	1...15 of effective sensing distance (Sr)
Degree of protection		Conforming to IEC 60529	IP 67 IP 68, double insulation
Storage temperature		°C	- 40...+ 85
Operating temperature		°C	- 25...+ 70
Materials		Case	Nickel plated brass
		Cable	PvR 2 x 0.34 mm <sup>2</sup>
Vibration resistance		Conforming to IEC 60068-2-6	25 gn, amplitude ± 2 mm (f = 10 to 55 Hz)
Shock resistance		Conforming to IEC 60068-2-27	50 gn, duration 11 ms
Indicators		Output state	Yellow LED, 4 viewing ports at 90°
		Supply on	Yellow LED Green LED (only on Ø 18 and Ø 30)
Rated supply voltage		V	~ 24...240 (50/60 Hz) or ~ 24...210
Voltage limits (including ripple)		V	~ or ~ 20...264
Switching capacity		mA	~ 5...300 or ~ 5...200 (except Ø 12: ~ or ~ 5...200) with overload and short-circuit protection
Voltage drop, closed state		V	≤ 5.5
Current consumption, no-load		mA	-
Residual current, open state		mA	≤ 1.5
Maximum switching frequency		Hz	Ø 12 ~ 25 or ~ 4000 Ø 18 ~ 25 or ~ 2000 Ø 30 flush mountable ~ 25 or ~ 2000 Ø 30 non flush mountable ~ 25 or ~ 1000
Delays		ms	First-up ≤ 70 Response ≤ 0.2 for Ø 12, ≤ 2 for Ø 18 and Ø 30 Recovery ≤ 0.2 for Ø 12, ≤ 4 for Ø 18, ≤ 5 for Ø 30 flush mountable, ≤ 10 for Ø 30 non flush mountable

## Wiring schemes

### 1/2"-20UNF connector



### Pre-cabled

BU: Blue  
BN: Brown

### 2-wire ~ or ~

NO or NC output

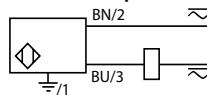

⊕ : on connector models only.

## Setting-up

### Minimum mounting distances (mm)

Sensor	Side by side	Face to face	Facing a metal object	Mounted in a metal support
Ø 12 flush mountable	e ≥ 4	e ≥ 24	e ≥ 6	d ≥ 12 h ≥ 0
Ø 12 non flush mountable	e ≥ 16	e ≥ 48	e ≥ 12	d ≥ 36 h ≥ 8
Ø 18 flush mountable	e ≥ 10	e ≥ 60	e ≥ 15	d ≥ 18 h ≥ 0
Ø 18 non flush mountable	e ≥ 16	e ≥ 96	e ≥ 24	d ≥ 54 h ≥ 16
Ø 30 flush mountable	e ≥ 20	e ≥ 120	e ≥ 30	d ≥ 30 h ≥ 0
Ø 30 non flush mountable	e ≥ 60	e ≥ 180	e ≥ 45	d ≥ 90 h ≥ 30

## Dimensions

Sensor	Flush mountable in metal					Non flush mountable in metal				
	Pre-cabled		Connector		c	Pre-cabled		Connector		c
	a	b	a	b		a	b	a	b	
Ø 12	55	47	66	48	5	55	42	66	42	5
Ø 18	60	51	72	51	8	60	44	72	44	8
Ø 30	60	51	72	51	13	63	41	75	41	13

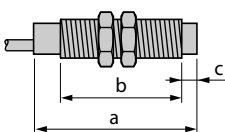

# Inductive proximity sensors

OsiSense XS, general purpose

Cylindrical, metal and plastic, flush mountable and non flush mountable

Four-wire DC, solid-state NO + NC output

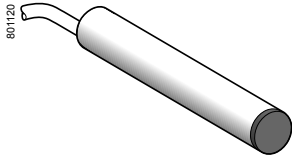

XS1L06●C410

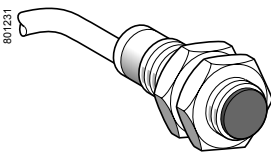

XS1●●●●C410

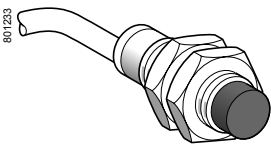

XS2●●●●C410

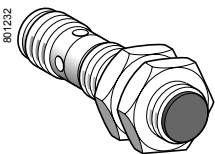

XS1N●●●C410D

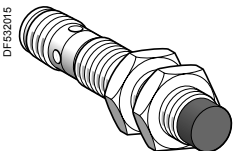

XS2N●●●C410D

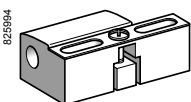

XSZB1●●

Sensing distance (Sn) mm	Function	Output	Connection	Reference	Weight kg
--------------------------	----------	--------	------------	-----------	-----------

### Ø 6.5 plain

#### Stainless steel case, flush mountable

1.5	NO + NC	PNP	Pre-cabled (L = 2 m) (1)	<b>XS1L06PC410</b>	0.025
		NPN	Pre-cabled (L = 2 m) (1)	<b>XS1L06NC410</b>	0.025

### Ø 8, threaded M8 x 1

#### Stainless steel case, flush mountable

1.5	NO + NC	PNP	Pre-cabled (L = 2 m)	<b>XS1M08PC410</b>	0.035
			M12 connector	<b>XS1M08PC410D</b>	0.025
		NPN	Pre-cabled (L = 2 m)	<b>XS1M08NC410</b>	0.035
			M12 connector	<b>XS1M08NC410D</b>	0.025

#### Stainless steel case, non flush mountable

2.5	NO + NC	PNP	Pre-cabled (L = 2 m)	<b>XS2M08PC410</b>	0.035
			M12 connector	<b>XS2M08PC410D</b>	0.025
		NPN	Pre-cabled (L = 2 m)	<b>XS2M08NC410</b>	0.035
			M12 connector	<b>XS2M08NC410D</b>	0.025

### Ø 12, threaded M12 x 1

#### Brass case, flush mountable

2	NO + NC	PNP	Pre-cabled (L = 2 m) (1)	<b>XS1N12PC410</b>	0.070
			M12 connector	<b>XS1N12PC410D</b>	0.020
		NPN	Pre-cabled (L = 2 m) (1)	<b>XS1N12NC410</b>	0.070
			M12 connector	<b>XS1N12NC410D</b>	0.020

#### Brass case, non flush mountable (2)

4	NO + NC	PNP	Pre-cabled (L = 2 m) (1)	<b>XS2N12PC410</b>	0.070
			M12 connector	<b>XS2N12PC410D</b>	0.020
		NPN	Pre-cabled (L = 2 m) (1)	<b>XS2N12NC410</b>	0.070
			M12 connector	<b>XS2N12NC410D</b>	0.020

### Ø 18, threaded M18 x 1

#### Brass case, flush mountable

5	NO + NC	PNP	Pre-cabled (L = 2 m) (1)	<b>XS1N18PC410</b>	0.100
			M12 connector	<b>XS1N18PC410D</b>	0.040
		NPN	Pre-cabled (L = 2 m) (1)	<b>XS1N18NC410</b>	0.100
			M12 connector	<b>XS1N18NC410D</b>	0.040

#### Brass case, non flush mountable (2)

8	NO + NC	PNP	Pre-cabled (L = 2 m) (1)	<b>XS2N18PC410</b>	0.100
			M12 connector	<b>XS2N18PC410D</b>	0.040
		NPN	Pre-cabled (L = 2 m) (1)	<b>XS2N18NC410</b>	0.100
			M12 connector	<b>XS2N18NC410D</b>	0.040

### Ø 30, threaded M30 x 1.5

#### Brass case, flush mountable

10	NO + NC	PNP	Pre-cabled (L = 2 m) (1)	<b>XS1N30PC410</b>	0.160
			M12 connector	<b>XS1N30PC410D</b>	0.100
		NPN	Pre-cabled (L = 2 m) (1)	<b>XS1N30NC410</b>	0.160
			M12 connector	<b>XS1N30NC410D</b>	0.100

#### Brass case, non flush mountable (2)

15	NO + NC	PNP	Pre-cabled (L = 2 m) (1)	<b>XS2N30PC410</b>	0.160
			M12 connector	<b>XS2N30PC410D</b>	0.100
		NPN	Pre-cabled (L = 2 m) (1)	<b>XS2N30NC410</b>	0.160
			M12 connector	<b>XS2N30NC410D</b>	0.100

### Accessories (3)

Description mm		Reference	Weight kg
Fixing clamps	Ø 8	<b>XSZB108</b>	0.006
	Ø 12	<b>XSZB112</b>	0.006
	Ø 18	<b>XSZB118</b>	0.010
	Ø 30	<b>XSZB130</b>	0.020

(1) For a 5 m long cable add L1 to the reference; for a 10 m long cable add L2 to the reference. Example: **XS1N12PC410** becomes **XS1N12PC410L1** with a 5 m long cable.

(2) For a sensor with a plastic case, non flush mountable, replace 2N by 4P in the reference. Example: **XS2N12PC410** becomes **XS4P12PC410** with a plastic case.

(3) For further information, see page 128.

# Inductive proximity sensors

OsiSense XS, general purpose

Cylindrical, metal and plastic, flush mountable and non flush mountable

Four-wire DC, solid-state NO + NC output

## Characteristics

Sensor type		XS●●●●●C410D	XS●●●●●C410
Product certifications		UL, CSA, CE	
Connection		M12 connector	Pre-cabled, length: 2 m
Operating zone	Ø 6.5 and Ø 8 flush mtable	mm	0...1.2
	Ø 8 non flush mountable	mm	0...2
	Ø 12 flush mountable	mm	0...1.6
	Ø 12 non flush mountable	mm	0...3.2
	Ø 18 flush mountable	mm	0...4
	Ø 18 non flush mountable	mm	0...6.4
	Ø 30 flush mountable	mm	0...8
	Ø 30 non flush mountable	mm	0...12
Differential travel		%	1...15 of effective sensing distance (Sr)
Degree of protection		Conforming to IEC 60529	IP 67 IP 68, double insulation (except Ø 6.5 and Ø 8: IP 67)
Storage temperature		°C	- 40...+ 85
Operating temperature		°C	- 25...+ 70
Materials	Case	Nickel plated brass for XS1N and XS2N Stainless steel, grade 303, for XS1L06, XS1M08 and XS2M08 Plastic, PPS, for XS4P	
	Cable	–	PvR 4 x 0.34 mm <sup>2</sup> except Ø 6.5 and 8: 4 x 0.08 mm <sup>2</sup>
Vibration resistance		Conforming to IEC 60068-2-6	25 gn, amplitude ± 2 mm (f = 10 to 55 Hz)
Shock resistance		Conforming to IEC 60068-2-27	50 gn, duration 11 ms
Output state indication			Yellow LED, 4 viewing ports at 90° Yellow LED, annular
Rated supply voltage		V	--- 12...24 with protection against reverse polarity
Voltage limits (including ripple)		V	--- 10...36
Switching capacity		mA	≤ 200 with overload and short-circuit protection
Voltage drop, closed state		V	≤ 2
Current consumption, no-load		mA	≤ 10
Maximum switching frequency	Ø 6.5, Ø 8 and Ø 12	Hz	5000
	Ø 18	Hz	2000
	Ø 30	Hz	1000
		Hz	1000
Delays	First-up	ms	≤ 5
	Response	ms	≤ 0.1 for Ø 8 and Ø 12, ≤ 0.15 for Ø 18, ≤ 0.3 for Ø 30
	Recovery	ms	≤ 0.1 for Ø 8 and Ø 12, ≤ 0.35 for Ø 18, ≤ 0.7 for Ø 30
		ms	≤ 0.1 for Ø 8 and Ø 12, ≤ 0.35 for Ø 18, ≤ 0.7 for Ø 30

## Wiring schemes

### M12 connector



### Pre-cabled

BU: Blue  
BN: Brown  
BK: Black  
WH: White

### PNP 4-wire

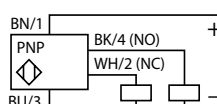

### NPN 4-wire

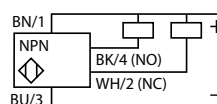

## Setting-up

### Minimum mounting distances (mm)

Sensor	Minimum mounting distances (mm)			
	Side by side	Face to face	Facing a metal object	Mounted in a metal support
Ø 6.5 flush mountable XS1L06	$e \geq 3$	$e \geq 18$	$e \geq 4.5$	$d \geq 6.5$ $h \geq 0$
Ø 8 flush mountable XS1M08	$e \geq 3$	$e \geq 18$	$e \geq 4.5$	$d \geq 8$ $h \geq 0$
Ø 8 non flush mountable XS2M08	$e \geq 10$	$e \geq 30$	$e \geq 7.5$	$d \geq 24$ $h \geq 5$
Ø 12 flush mountable XS1N12	$e \geq 4$	$e \geq 24$	$e \geq 6$	$d \geq 12$ $h \geq 0$
Ø 12 non flush mtable XS2N12 or XS4P12	$e \geq 16$	$e \geq 48$	$e \geq 12$	$d \geq 36$ $h \geq 8$
Ø 18 flush mountable XS1N18	$e \geq 10$	$e \geq 60$	$e \geq 15$	$d \geq 18$ $h \geq 0$
Ø 18 non flush mtable XS2N18 or XS4P18	$e \geq 16$	$e \geq 96$	$e \geq 24$	$d \geq 54$ $h \geq 16$
Ø 30 flush mountable XS1N30	$e \geq 20$	$e \geq 120$	$e \geq 30$	$d \geq 30$ $h \geq 0$
Ø 30 non flush mtable XS2N30 or XS4P30	$e \geq 60$	$e \geq 180$	$e \geq 45$	$d \geq 90$ $h \geq 30$

## Dimensions

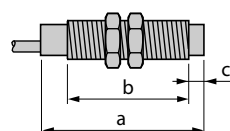

Sensor	Flush mountable in metal				Non flush mountable in metal				
	Pre-cabled		Connector		Pre-cabled		Connector		
	a	b	a	b	a	b	a	b	c
Ø 6.5 metal	50	–	–	–	–	–	–	–	–
Ø 8 metal	50	42	61	42	50	36	61	36	4
Ø 12 metal	33	25	48	29	38	25	53	29	5
Ø 12 plastic	–	–	–	–	33	25	48	29	0
Ø 18 metal	37	28	49	28	37	20	49	20	8
Ø 18 plastic	–	–	–	–	34	26	48	29	0
Ø 30 metal	41	32	53	32	41	19	53	19	13
Ø 30 plastic	–	–	–	–	41	33	50	34	0

# Inductive proximity sensors

OsiSense XS, general purpose

Cylindrical, metal and plastic, flush and non flush mountable

Four-wire DC, solid-state PNP + NPN NO/NC programmable output

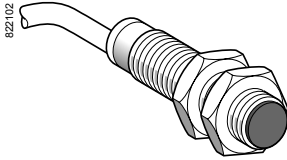

XS1M●●KP340  
XS4P●●KP340

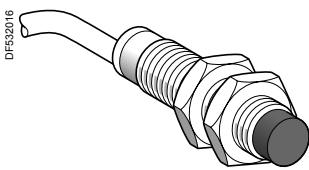

XS2M●●KP340

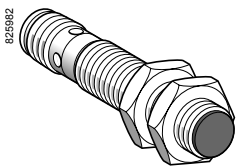

XS1M●●KP340D  
XS4P●●KP340D

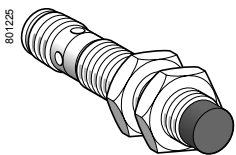

XS2M●●KP340D

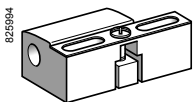

XSZB1●●

Sensing distance (Sn) mm	Function	Output	Connection	Reference	Weight kg
<b>Ø 12, threaded M12 x 1</b>					
<b>Metal case, flush mountable</b>					
2	NO/NC programmable	PNP + NPN	Pre-cabled (L = 2 m) (1) M12 connector	<b>XS1M12KP340</b> <b>XS1M12KP340D</b>	0.075 0.025
<b>Metal case, non flush mountable</b>					
4	NO/NC programmable	PNP + NPN	Pre-cabled (L = 2 m) (1) M12 connector	<b>XS2M12KP340</b> <b>XS2M12KP340D</b>	0.075 0.025
<b>Plastic case, non flush mountable</b>					
4	NO/NC programmable	PNP + NPN	Pre-cabled (L = 2 m) (1) M12 connector	<b>XS4P12KP340</b> <b>XS4P12KP340D</b>	0.075 0.025
<b>Ø 18, threaded M18 x 1</b>					
<b>Metal case, flush mountable</b>					
5	NO/NC programmable	PNP + NPN	Pre-cabled (L = 2 m) (1) M12 connector	<b>XS1M18KP340</b> <b>XS1M18KP340D</b>	0.120 0.060
<b>Metal case, non flush mountable</b>					
8	NO/NC programmable	PNP + NPN	Pre-cabled (L = 2 m) (1) M12 connector	<b>XS2M18KP340</b> <b>XS2M18KP340D</b>	0.120 0.060
<b>Plastic case, non flush mountable</b>					
8	NO/NC programmable	PNP + NPN	Pre-cabled (L = 2 m) (1) M12 connector	<b>XS4P18KP340</b> <b>XS4P18KP340D</b>	0.120 0.060
<b>Ø 30, threaded M30 x 1.5</b>					
<b>Metal case, flush mountable</b>					
10	NO/NC programmable	PNP + NPN	Pre-cabled (L = 2 m) (1) M12 connector	<b>XS1M30KP340</b> <b>XS1M30KP340D</b>	0.205 0.145
<b>Metal case, non flush mountable</b>					
15	NO/NC programmable	PNP + NPN	Pre-cabled (L = 2 m) (1) M12 connector	<b>XS2M30KP340</b> <b>XS2M30KP340D</b>	0.205 0.145
<b>Plastic case, non flush mountable</b>					
15	NO/NC programmable	PNP + NPN	Pre-cabled (L = 2 m) (1) M12 connector	<b>XS4P30KP340</b> <b>XS4P30KP340D</b>	0.205 0.145
<b>Accessories (2)</b>					
Description mm				Reference	Weight kg
Fixing clamps		Ø 12		<b>XSZB112</b>	0.006
		Ø 18		<b>XSZB118</b>	0.010
		Ø 30		<b>XSZB130</b>	0.020

(1) For a 5 m long cable add L1 to the reference; for a 10 m long cable add L2 to the reference.  
Example: XS1M12KP340 becomes XS1M12KP340L1 with a 5 m long cable.

(2) For further information, see page 128.

# Inductive proximity sensors

OsiSense XS, general purpose

Cylindrical, metal and plastic, flush and non flush mountable

Four-wire DC, solid-state PNP + NPN NO/NC

programmable output

Characteristics		XS●M●●KP340D	XS●M●●KP340
Sensor type			
Product certifications		UL, CSA, CE	
Connection		M12 connector	Pre-cabled, length: 2 m
Operating zone	Ø 12 flush mountable	mm	0...1.6
	Ø 12 non flush mountable	mm	0...3.2
	Ø 18 flush mountable	mm	0...4
	Ø 18 non flush mountable	mm	0...6.4
	Ø 30 flush mountable	mm	0...8
	Ø 30 non flush mountable	mm	0...12
Differential travel		%	1...15 of effective sensing distance (Sr)
Degree of protection		Conforming to IEC 60529	IP 67 IP 68, double insulation
Storage temperature		°C	- 40...+ 85
Operating temperature		°C	- 25...+ 70
Materials		Case	Nickel plated brass for XS1M and XS2M, PPS for XS4P
	Cable		PvR 4 x 0.34 mm <sup>2</sup>
Vibration resistance		Conforming to IEC 60068-2-6	25 gn, amplitude ± 2 mm (f = 10 to 55 Hz)
Shock resistance		Conforming to IEC 60068-2-27	50 gn, duration 11 ms
Output state indication			Yellow LED, 4 viewing ports at 90° Yellow LED, annular
Rated supply voltage		V	--- 12...24 with protection against reverse polarity
Voltage limits (including ripple)		V	--- 10...36
Switching capacity		mA	≤ 200 with overload and short-circuit protection
Voltage drop, closed state		V	≤ 2.6
Current consumption, no-load		mA	≤ 10
Maximum switching frequency	Ø 12	Hz	5000
	Ø 18	Hz	2000
	Ø 30 flush mountable	Hz	1000
	Ø 30 non flush mountable	Hz	1000
Delays	First-up	ms	≤ 5
	Response	ms	≤ 0.1 for Ø 12, ≤ 0.15 for Ø 18, ≤ 0.3 for Ø 30
	Recovery	ms	≤ 0.1 for Ø 12, ≤ 0.35 for Ø 18, ≤ 0.7 for Ø 30

## Wiring schemes

### M12 connector



### Pre-cabled

BU: Blue  
BN: Brown  
BK: Black  
WH: White

### PNP + NPN

#### 4-wire programmable, NO or NC output

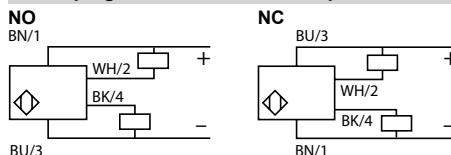

## Setting-up

Sensor	Minimum mounting distances (mm)			
	Side by side	Face to face	Facing a metal object	Mounted in a metal support
Ø 12 flush mountable XS1M12	e ≥ 4	e ≥ 24	e ≥ 6	d ≥ 12 h ≥ 0
Ø 12 non flush mountable XS2M12 and XS4P12	e ≥ 16	e ≥ 48	e ≥ 12	d ≥ 36 h ≥ 8
Ø 18 flush mountable XS1M18	e ≥ 10	e ≥ 60	e ≥ 15	d ≥ 18 h ≥ 0
Ø 18 non flush mountable XS2M18 and XS4P18	e ≥ 16	e ≥ 96	e ≥ 24	d ≥ 54 h ≥ 16
Ø 30 flush mountable XS1M30	e ≥ 20	e ≥ 120	e ≥ 30	d ≥ 30 h ≥ 0
Ø 30 non flush mountable XS2M30 and XS4P30	e ≥ 60	e ≥ 180	e ≥ 45	d ≥ 90 h ≥ 30

## Dimensions

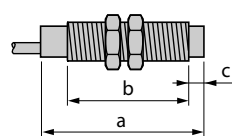

Sensor	Flush mountable in metal				Non flush mountable in metal				
	Pre-cabled		Connector		Pre-cabled		Connector		c
	a	b	a	b	a	b	a	b	
Ø 12 metal	50	42	61	42	55	42	66	42	5
Ø 12 plastic	-	-	-	-	50	42	61	42	0
Ø 18 metal	60	51	72	51	60	44	72	44	8
Ø 18 plastic	-	-	-	-	60	51	70	51	0
Ø 30 metal	60	51	72	51	63	41	75	41	13
Ø 30 plastic	-	-	-	-	60	51	70	51	0



# Inductive proximity sensors

OsiSense XS, general purpose  
 Plastic, cylindrical, non flush mountable  
 Two-wire AC or DC  
 Three-wire DC, solid-state output

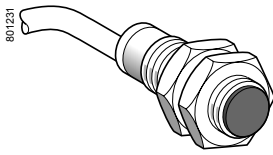

XS4P●●●●340  
 XS4P●●●●370  
 XS4P●●●●230

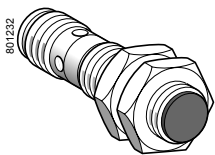

XS4P●●●●340D  
 XS4P●●●●370D  
 XS4P●●●●230K

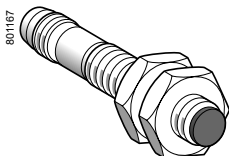

XS4P08●●340S

Sensing dist. (Sn) mm	Function	Output	Connection	Reference	Weight kg
<b>Ø 8, threaded M8 x 1</b>					
<b>Three-wire ∴ 12-24 V</b>					
2.5	NO	PNP	Pre-cabled (L = 2 m) (1) (2)	<b>XS4P08PA340</b>	0.025
		NPN	Pre-cabled (L = 2 m) (1) (2)	<b>XS4P08NA340</b>	0.025
	NC	PNP	Pre-cabled (L = 2 m) (1) (2)	<b>XS4P08PB340</b>	0.025
		NPN	Pre-cabled (L = 2 m) (1) (2)	<b>XS4P08NB340</b>	0.025
<b>Three-wire ∴ 12-48 V</b>					
2.5	NO	PNP	Pre-cabled (L = 2 m) (1)	<b>XS4P08PA370</b>	0.030
		NPN	Pre-cabled (L = 2 m)	<b>XS4P08NA370</b>	0.030
	NC	PNP	Pre-cabled (L = 2 m)	<b>XS4P08PB370</b>	0.030
		NPN	Pre-cabled (L = 2 m)	<b>XS4P08NB370</b>	0.030
<b>Two-wire ~ or ∴ 24-240 V</b>					
2.5	NO		Pre-cabled (L = 2 m) (1)	<b>XS4P08MA230</b>	0.030
			1/2"-20UNF connector	<b>XS4P08MA230K</b>	0.020
	NC		Pre-cabled (L = 2 m) (1)	<b>XS4P08MB230</b>	0.030
			1/2"-20UNF connector	<b>XS4P08MB230K</b>	0.020
<b>Ø 12, threaded M12 x 1</b>					
<b>Three-wire ∴ 12-24 V</b>					
4	NO	PNP	Pre-cabled (L = 2 m) (1) (3)	<b>XS4P12PA340</b>	0.060
		NPN	Pre-cabled (L = 2 m) (1) (3)	<b>XS4P12NA340</b>	0.060
	NC	PNP	Pre-cabled (L = 2 m) (1) (3)	<b>XS4P12PB340</b>	0.060
		NPN	Pre-cabled (L = 2 m) (1) (3)	<b>XS4P12NB340</b>	0.060
<b>Three-wire ∴ 12-48 V</b>					
4	NO	PNP	Pre-cabled (L = 2 m) (1) (3)	<b>XS4P12PA370</b>	0.065
		NPN	Pre-cabled (L = 2 m) (1) (3)	<b>XS4P12NA370</b>	0.065
	NC	PNP	Pre-cabled (L = 2 m) (1) (3)	<b>XS4P12PB370</b>	0.065
		NPN	Pre-cabled (L = 2 m) (3)	<b>XS4P12NB370</b>	0.065
<b>Two-wire ~ or ∴ 24-240 V</b>					
4	NO		Pre-cabled (L = 2 m) (1)	<b>XS4P12MA230</b>	0.065
			1/2"-20UNF connector	<b>XS4P12MA230K</b>	0.030
	NC		Pre-cabled (L = 2 m) (1)	<b>XS4P12MB230</b>	0.065
			1/2"-20UNF connector	<b>XS4P12MB230K</b>	0.030
<b>Ø 18, threaded M18 x 1</b>					
<b>Three-wire ∴ 12-24 V</b>					
8	NO	PNP	Pre-cabled (L = 2 m) (1) (3)	<b>XS4P18PA340</b>	0.090
		NPN	Pre-cabled (L = 2 m) (1) (3)	<b>XS4P18NA340</b>	0.090
	NC	PNP	Pre-cabled (L = 2 m) (1) (3)	<b>XS4P18PB340</b>	0.090
		NPN	Pre-cabled (L = 2 m) (1) (3)	<b>XS4P18NB340</b>	0.090
<b>Three-wire ∴ 12-48 V</b>					
8	NO	PNP	Pre-cabled (L = 2 m) (1) (3)	<b>XS4P18PA370</b>	0.100
		NPN	Pre-cabled (L = 2 m) (1) (3)	<b>XS4P18NA370</b>	0.100
	NC	PNP	Pre-cabled (L = 2 m) (1) (3)	<b>XS4P18PB370</b>	0.100
		NPN	Pre-cabled (L = 2 m) (3)	<b>XS4P18NB370</b>	0.100
<b>Two-wire ~ or ∴ 24-240 V</b>					
8	NO		Pre-cabled (L = 2 m) (1)	<b>XS4P18MA230</b>	0.100
			1/2"-20UNF connector	<b>XS4P18MA230K</b>	0.040
	NC		Pre-cabled (L = 2 m) (1)	<b>XS4P18MB230</b>	0.100
			1/2"-20UNF connector	<b>XS4P18MB230K</b>	0.040
<b>Ø 30, threaded M30 x 1.5</b>					
<b>Three-wire ∴ 12-24 V</b>					
15	NO	PNP	Pre-cabled (L = 2 m) (1) (3)	<b>XS4P30PA340</b>	0.120
		NPN	Pre-cabled (L = 2 m) (1) (3)	<b>XS4P30NA340</b>	0.120
	NC	PNP	Pre-cabled (L = 2 m) (1) (3)	<b>XS4P30PB340</b>	0.120
		NPN	Pre-cabled (L = 2 m) (1) (3)	<b>XS4P30NB340</b>	0.120
<b>Three-wire ∴ 12-48 V</b>					
15	NO	PNP	Pre-cabled (L = 2 m) (1) (3)	<b>XS4P30PA370</b>	0.140
		NPN	Pre-cabled (L = 2 m) (1) (3)	<b>XS4P30NA370</b>	0.140
	NC	PNP	Pre-cabled (L = 2 m) (3)	<b>XS4P30PB370</b>	0.140
		NPN	Pre-cabled (L = 2 m) (3)	<b>XS4P30NB370</b>	0.140
<b>Two-wire ~ or ∴</b>					
15	NO		Pre-cabled (L = 2 m) (1)	<b>XS4P30MA230</b>	0.140
			1/2"-20UNF connector	<b>XS4P30MA230K</b>	0.080
	NC		Pre-cabled (L = 2 m) (1)	<b>XS4P30MB230</b>	0.140
			1/2"-20UNF connector	<b>XS4P30MB230K</b>	0.080

(1) For a 5 m long cable add L1 to the reference; for a 10 m long cable add L2 to the reference. Example: **XS4P08PA340** becomes **XS4P08PA340L1** with a 5 m long cable.  
 (2) For an M8 connector, add S to the reference. Example: **XS4P08PA340** becomes **XS4P08PA340S** with an M8 connector.  
 (3) For an M12 connector, add D to the reference. Example: **XS4P12PA370** becomes **XS4P12PA370D** with an M12 connector.



# Inductive proximity sensors

OsiSense XS, general purpose

Plastic, cylindrical, non flush mountable

Two-wire AC or DC

Three-wire DC, solid-state output

Characteristics		XS4P●●●●340●	XS4P●●●●370●	XS4P●●M●230●
Sensor type		UL, CSA, CE		
Product certifications		UL, CSA, CE		
Connection	Pre-cabled	Length: 2 m		
	Connector	M8 on Ø 8 M12 on Ø 12, Ø 18 and Ø 30	1/2"-20UNF	
Operating zone	Ø 6.5 and Ø 8	mm	0...2	
	Ø 12	mm	0...3.2	
	Ø 18	mm	0...6.4	
	Ø 30	mm	0...12	
Differential travel		%		
Degree of protection		1...15 of effective sensing distance (Sr)		
Storage temperature		°C		
Operating temperature		°C		
Materials	Case	PPS		
	Cable	PvR 3 x 0.34 mm <sup>2</sup> except Ø 6.5 and 8: 3 x 0.11 mm <sup>2</sup>		PvR 2 x 0.34 mm <sup>2</sup> except Ø 8: 2 x 0.11 mm <sup>2</sup>
Vibration resistance		Conforming to IEC 60068-2-6		
Shock resistance		Conforming to IEC 60068-2-27		
Output state indication		Yellow LED: annular on pre-cabled version Yellow LED: 4 viewing ports at 90° on connector version		
Rated supply voltage		V	~ 12...24 with protection against reverse polarity	~ 12...48 with protection against reverse polarity
Voltage limits (including ripple)		V	~ 10...36	~ 10...58
Switching capacity		mA	≤ 200 with overload and short-circuit protection	~ or ~ 20...264
Voltage drop, closed state		V	≤ 2	≤ 5.5
Residual current, open state		mA	–	≤ 0.6
Current consumption, no-load		mA	≤ 10	–
Maximum switching frequency	Ø 6.5, Ø 8 and Ø 12	Hz	5000	~ 3000, ~ 25
	Ø 18	Hz	2000	~ 2000, ~ 25
	Ø 30	Hz	1000	~ 1000, ~ 25
Delays	First-up	ms	≤ 10	≤ 40
	Response	ms	≤ 0.1 for Ø 8 and Ø 12, ≤ 0.15 for Ø 18, ≤ 0.3 for Ø 30	≤ 0.2
	Recovery	ms	≤ 0.1 for Ø 8 and Ø 12, ≤ 0.35 for Ø 18, ≤ 0.7 for Ø 30	≤ 0.2 for Ø 8, Ø 12 and Ø 18, ≤ 0.4 for Ø 30

### Wiring schemes

Connector	Pre-cabled	PNP	NPN	2-wire ~ or ~
M8	BU: Blue BN: Brown BK: Black			
M12				
1/2"-20UNF		For M8 connector, NO and NC outputs on terminal 4		

### Setting-up

Minimum mounting distances (mm)

Side by side	Face to face	Facing a metal object	Mounted in a metal support
Ø 8	e ≥ 30	e ≥ 7.5	d ≥ 24 h ≥ 5
Ø 12	e ≥ 48	e ≥ 12	d ≥ 36 h ≥ 8
Ø 18	e ≥ 96	e ≥ 24	d ≥ 54 h ≥ 16
Ø 30	e ≥ 60	e ≥ 45	d ≥ 90 h ≥ 30

### Dimensions

XS4P	3-wire ~ 12-24 V				3-wire ~ 12-48 V or 2-wire ~/~ 24-240 V			
	Pre-cabled (mm)		Connector (mm)		Pre-cabled (mm)		Connector (mm)	
Ø 8	a	b	a	b	a	b	a	b
Ø 8	33	26	42	26	50	40	61	40
Ø 12	35	25	48	27	52	42	61	42
Ø 18	36	25	48	29	62	52	70	52
Ø 30	43	32	50	34	62	52	70	52

# Inductive proximity sensors

OsiSense XS, general purpose

Basic, plastic, cylindrical, non flush mountable

Three-wire DC, solid-state output

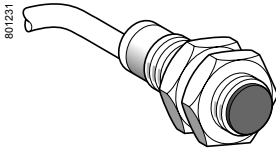

XS2●●AL●●L2



XS2●●AL●●M12

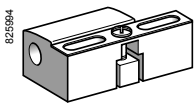

XSZB1●●

Sensing distance (Sn) mm	Function	Output	Connection	Reference	Weight kg
<b>Ø 8, threaded M8 x 1</b>					
<b>Three-wire 12-24 V, non flush mountable</b>					
2.5	NO	PNP	Pre-cabled (L = 2 m) (1)	<b>XS208ALPAL2</b>	0.030
		NPN	Pre-cabled (L = 2 m) (1)	<b>XS208ALNAL2</b>	0.030
	NC	PNP	Pre-cabled (L = 2 m) (1)	<b>XS208ALPBL2</b>	0.003
		NPN	Pre-cabled (L = 2 m) (1)	<b>XS208ALNBL2</b>	0.030
<b>Ø 12, threaded M12 x 1</b>					
<b>Three-wire 12-24 V, non flush mountable</b>					
4	NO	PNP	Pre-cabled (L = 2 m) (2)	<b>XS212ALPAL2</b>	0.065
			M12 connector	<b>XS212ALPAM12</b>	0.010
		NPN	Pre-cabled (L = 2 m) (2)	<b>XS212ALNAL2</b>	0.065
			M12 connector	<b>XS212ALNAM12</b>	0.010
	NC	PNP	Pre-cabled (L = 2 m) (2)	<b>XS212ALPBL2</b>	0.065
			M12 connector	<b>XS212ALPBM12</b>	0.010
		NPN	Pre-cabled (L = 2 m) (2)	<b>XS212ALNBL2</b>	0.065
			M12 connector	<b>XS212ALNBM12</b>	0.010
<b>Ø 18, threaded M18 x 1</b>					
<b>Three-wire 12-24 V, non flush mountable</b>					
8	NO	PNP	Pre-cabled (L = 2 m) (2)	<b>XS218ALPAL2</b>	0.095
			M12 connector	<b>XS218ALPAM12</b>	0.025
		NPN	Pre-cabled (L = 2 m) (2)	<b>XS218ALNAL2</b>	0.095
			M12 connector	<b>XS218ALNAM12</b>	0.025
	NC	PNP	Pre-cabled (L = 2 m) (2)	<b>XS218ALPBL2</b>	0.095
			M12 connector	<b>XS218ALPBM12</b>	0.025
		NPN	Pre-cabled (L = 2 m) (2)	<b>XS218ALNBL2</b>	0.095
			M12 connector	<b>XS218ALNBM12</b>	0.025
<b>Ø 30, threaded M30 x 1.5</b>					
<b>Three-wire 12-24 V, non flush mountable</b>					
15	NO	PNP	Pre-cabled (L = 2 m) (2)	<b>XS230ALPAL2</b>	0.135
			M12 connector	<b>XS230ALPAM12</b>	0.065
		NPN	Pre-cabled (L = 2 m) (2)	<b>XS230ALNAL2</b>	0.135
			M12 connector	<b>XS230ALNAM12</b>	0.065
	NC	PNP	Pre-cabled (L = 2 m) (2)	<b>XS230ALPBL2</b>	0.135
			M12 connector	<b>XS230ALPBM12</b>	0.065
		NPN	Pre-cabled (L = 2 m) (2)	<b>XS230ALNBL2</b>	0.135
			M12 connector	<b>XS230ALNBM12</b>	0.065
<b>Accessories (3)</b>					
<b>Description</b>			<b>Reference</b>	<b>Weight kg</b>	
Fixing clamps			Ø 8	<b>XSZB108</b>	0.006
			Ø 12	<b>XSZB112</b>	0.006
			Ø 18	<b>XSZB118</b>	0.010
			Ø 30	<b>XSZB130</b>	0.020

(1) For a 5 m long cable replace L2 by L5.

Example: XS208ALPAL2 becomes **XS208ALPAL5** with a 5 m long cable.

(2) For a 5 m long cable replace L2 by L5; for a 10 m long cable replace L2 by L10.

Example: XS218ALPAL2 becomes **XS218ALPAL5** with a 5 m long cable.

(3) For further information, see page 128.

Characteristics		XS2●●ALP●L2 XS2●●ALN●L2	XS2●●ALP●M12 XS2●●ALN●M12
Sensor type			
Product certifications		UL, CSA, CE	
Connection	Pre-cabled	Length: 2 m	
	Connector	M12	
Operating zone (1)	Ø 8	mm	0...2
	Ø 12	mm	0...3.2
	Ø 18	mm	0...6.4
	Ø 30	mm	0...12
Differential travel		%	
Degree of protection		Conforming to IEC 60529	
Storage temperature		°C	
Operating temperature		°C	
Materials	Case	PPS	
	Cable	PVC 3 x 0.34 mm <sup>2</sup> except Ø 8: 3 x 0.11 mm <sup>2</sup>	
Vibration resistance		Conforming to IEC 60068-2-6	
Shock resistance		Conforming to IEC 60068-2-27	
Output state indication		Yellow LED, on rear	
Rated supply voltage		V	
Voltage limits (including ripple)		V	
Switching capacity		mA	
Voltage drop, closed state		V	
Current consumption, no-load		mA	
Maximum switching frequency	Ø 8	Hz	1000
	Ø 12	Hz	1000
	Ø 18	Hz	1000
	Ø 30	Hz	1000
Delays	First-up	ms	≤ 5
	Response	ms	≤ 0.3
	Recovery	ms	≤ 0.3

(1) Detection curves, see page 132.

## Wiring schemes

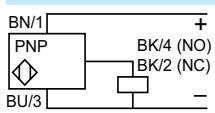
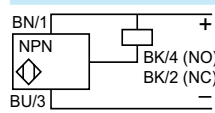
Connector	Pre-cabled	PNP	NPN
M12	BU: Blue BN: Brown BK: Black		

## Setting-up

### Minimum mounting distances (mm)



Sensors	Side by side	Face to face	Facing a metal object	Mounted in a metal support
Ø 8 XS208AL	e ≥ 10	e ≥ 30	e ≥ 7.5	d ≥ 24 h ≥ 5
Ø 12 XS212AL	e ≥ 16	e ≥ 48	e ≥ 12	d ≥ 36 h ≥ 8
Ø 18 XS218AL	e ≥ 16	e ≥ 96	e ≥ 24	d ≥ 54 h ≥ 16
Ø 30 XS230AL	e ≥ 60	e ≥ 180	e ≥ 45	d ≥ 90 h ≥ 30

## Dimensions

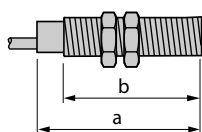

Sensors		Non flush mountable in metal			
		Pre-cabled (mm)		Connector (mm)	
		a	b	a	b
Ø 8	XS208AL	49	40	–	–
Ø 12	XS212AL	49	42	61	42
Ø 18	XS218AL	59	52	71	52
Ø 30	XS230AL	59	52	71	52

# Inductive proximity sensors

OsiSense XS, general purpose

Basic, cylindrical, metal, flush and non flush mountable

Two-wire AC

Three-wire DC, solid-state output

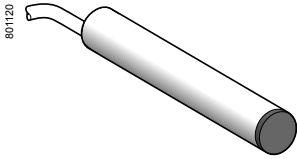

XS106BL●●L2

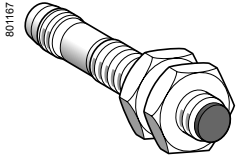

XS108BL●●M8

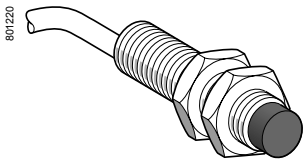

XS208BL●●L2

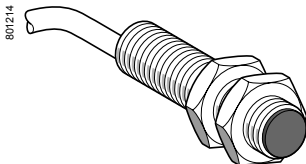

XS112BL●●L2

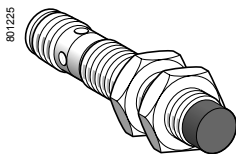

XS212BL●●M12

Sensing distance (Sn) mm	Function	Output	Connection	Reference	Weight kg
<b>Ø 6.5, plain</b>					
<b>Three-wire ≡ 12-24 V, flush mountable</b>					
1.5	NO	PNP	Pre-cabled (L = 2 m) (1)	<b>XS106BLPAL2</b>	0.030
		NPN	Pre-cabled (L = 2 m) (1)	<b>XS106BLNAL2</b>	0.030
	NC	PNP	Pre-cabled (L = 2 m) (1)	<b>XS106BLPBL2</b>	0.030
		NPN	Pre-cabled (L = 2 m) (1)	<b>XS106BLNBL2</b>	0.030
<b>Ø 8, threaded M8 x 1</b>					
<b>Three-wire ≡ 12-24 V, flush mountable</b>					
1.5	NO	PNP	Pre-cabled (L = 2 m) (1)	<b>XS108BLPAL2</b>	0.035
			M8 connector	<b>XS108BLPAM8</b>	0.008
			M12 connector	<b>XS108BLPAM12</b>	0.015
		NPN	Pre-cabled (L = 2 m) (1)	<b>XS108BLNAL2</b>	0.035
			M8 connector	<b>XS108BLNAM8</b>	0.008
			M12 connector	<b>XS108BLNAM12</b>	0.015
	NC	PNP	Pre-cabled (L = 2 m) (1)	<b>XS108BLPBL2</b>	0.035
			M8 connector	<b>XS108BLPBM8</b>	0.008
			M12 connector	<b>XS108BLPBM12</b>	0.015
		NPN	Pre-cabled (L = 2 m) (1)	<b>XS108BLNBL2</b>	0.035
			M8 connector	<b>XS108BLNBM8</b>	0.008
			M12 connector	<b>XS108BLNBM12</b>	0.015
<b>Three-wire ≡ 12-24 V, non flush mountable</b>					
2.5	NO	PNP	Pre-cabled (L = 2 m) (1)	<b>XS208BLPAL2</b>	0.035
			M8 connector	<b>XS208BLPAM8</b>	0.008
			M12 connector	<b>XS208BLPAM12</b>	0.015
		NPN	Pre-cabled (L = 2 m) (1)	<b>XS208BLNAL2</b>	0.035
			M8 connector	<b>XS208BLNAM8</b>	0.008
			M12 connector	<b>XS208BLNAM12</b>	0.015
	NC	PNP	Pre-cabled (L = 2 m) (1)	<b>XS208BLPBL2</b>	0.035
			M8 connector	<b>XS208BLPBM8</b>	0.008
			M12 connector	<b>XS208BLPBM12</b>	0.015
		NPN	Pre-cabled (L = 2 m) (1)	<b>XS208BLNBL2</b>	0.035
			M8 connector	<b>XS208BLNBM8</b>	0.008
			M12 connector	<b>XS208BLNBM12</b>	0.015
<b>Ø 12, threaded M12 x 1</b>					
<b>Three-wire ≡ 12-24 V, flush mountable</b>					
2	NO	PNP	Pre-cabled (L = 2 m) (2)	<b>XS112BLPAL2</b>	0.070
			M12 connector	<b>XS112BLPAM12</b>	0.015
			M12 connector	<b>XS112BLNAM12</b>	0.015
		NPN	Pre-cabled (L = 2 m) (2)	<b>XS112BLNAL2</b>	0.070
			M12 connector	<b>XS112BLNAM12</b>	0.015
			M12 connector	<b>XS112BLNAM12</b>	0.015
	NC	PNP	Pre-cabled (L = 2 m) (2)	<b>XS112BLPBL2</b>	0.070
			M12 connector	<b>XS112BLPBM12</b>	0.015
			M12 connector	<b>XS112BLPBM12</b>	0.015
		NPN	Pre-cabled (L = 2 m) (2)	<b>XS112BLNBL2</b>	0.070
			M12 connector	<b>XS112BLNBM12</b>	0.015
			M12 connector	<b>XS112BLNBM12</b>	0.015
<b>Two-wire ~ 24-240 V, flush mountable</b>					
2	NO		Pre-cabled (L = 2 m) (2)	<b>XS112BLFAL2</b>	0.075
<b>Three-wire ≡ 12-24 V, non flush mountable</b>					
4	NO	PNP	Pre-cabled (L = 2 m) (2)	<b>XS212BLPAL2</b>	0.070
			M12 connector	<b>XS212BLPAM12</b>	0.015
			M12 connector	<b>XS212BLNAM12</b>	0.015
		NPN	Pre-cabled (L = 2 m) (2)	<b>XS212BLNAL2</b>	0.070
			M12 connector	<b>XS212BLNAM12</b>	0.015
			M12 connector	<b>XS212BLNAM12</b>	0.015
	NC	PNP	Pre-cabled (L = 2 m) (2)	<b>XS212BLPBL2</b>	0.070
			M12 connector	<b>XS212BLPBM12</b>	0.015
			M12 connector	<b>XS212BLPBM12</b>	0.015
		NPN	Pre-cabled (L = 2 m) (2)	<b>XS212BLNBL2</b>	0.070
			M12 connector	<b>XS212BLNBM12</b>	0.015
			M12 connector	<b>XS212BLNBM12</b>	0.015

(1) For a 5 m long cable replace L2 by L5.

Example: XS106BLPAL2 becomes XS106BLPAL5 with a 5 m long cable.

(2) For a 5 m long cable replace L2 by L5; for a 10 m long cable replace L2 by L10.

Example: XS112BLPAL2 becomes XS112BLPAL5 with a 5 m long cable.

# Inductive proximity sensors

## OsiSense XS, general purpose

Basic, cylindrical, metal, flush and non flush mountable

Two-wire AC

Three-wire DC, solid-state output

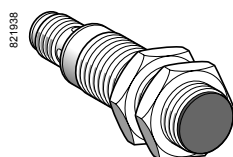

XS118BL●●M12

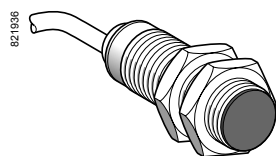

XS118BL●●●L2

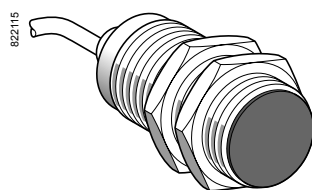

XS130BL●●L2

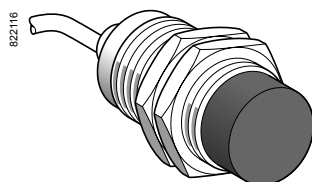

XS230BL●●L2

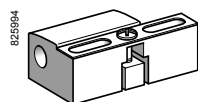

XSZB1●●

Sensing distance (Sn) mm	Function	Output	Connection	Reference	Weight kg
<b>Ø 18, threaded M18 x 1</b>					
<b>Three-wire ~ 12-24 V, flush mountable</b>					
5	NO	PNP	Pre-cabled (L = 2 m) (1) M12 connector	XS118BLPAL2	0.105
		NPN	Pre-cabled (L = 2 m) (1) M12 connector	XS118BLNAL2	0.105
				XS118BLNAM12	0.035
	NC	PNP	Pre-cabled (L = 2 m) (1) M12 connector	XS118BLPBL2	0.105
				XS118BLPBM12	0.035
		NPN	Pre-cabled (L = 2 m) (1) M12 connector	XS118BLNBL2	0.105
			XS118BLNBM12	0.035	
<b>Two-wire ~ 24-240 V, flush mountable</b>					
5	NO		Pre-cabled (L = 2 m) (1)	XS118BLFAL2	0.120
<b>Three-wire ~ 12-24 V, non flush mountable</b>					
8	NO	PNP	Pre-cabled (L = 2 m) (1) M12 connector	XS218BLPAL2	0.105
				XS218BLPAM12	0.035
		NPN	Pre-cabled (L = 2 m) (1) M12 connector	XS218BLNAL2	0.105
			XS218BLNAM12	0.035	
	NC	PNP	Pre-cabled (L = 2 m) (1) M12 connector	XS218BLPBL2	0.105
				XS218BLPBM12	0.035
NPN		Pre-cabled (L = 2 m) (1) M12 connector	XS218BLNBL2	0.105	
			XS218BLNBM12	0.035	
<b>Ø 30, threaded M30 x 1.5</b>					
<b>Three-wire ~ 12-24 V, flush mountable</b>					
10	NO	PNP	Pre-cabled (L = 2 m) (1) M12 connector	XS130BLPAL2	0.165
				XS130BLPAM12	0.075
		NPN	Pre-cabled (L = 2 m) (1) M12 connector	XS130BLNAL2	0.165
			XS130BLNAM12	0.075	
	NC	PNP	Pre-cabled (L = 2 m) (1) M12 connector	XS130BLPBL2	0.165
				XS130BLPBM12	0.075
NPN		Pre-cabled (L = 2 m) (1) M12 connector	XS130BLNBL2	0.165	
			XS130BLNBM12	0.075	
<b>Two-wire ~ 24-240 V, flush mountable</b>					
10	NO		Pre-cabled (L = 2 m) (1)	XS130BLFAL2	0.205
<b>Three-wire ~ 12-24 V, non flush mountable</b>					
15	NO	PNP	Pre-cabled (L = 2 m) (1) M12 connector	XS230BLPAL2	0.155
				XS230BLPAM12	0.085
		NPN	Pre-cabled (L = 2 m) (1) M12 connector	XS230BLNAL2	0.155
			XS230BLNAM12	0.085	
	NC	PNP	Pre-cabled (L = 2 m) (1) M12 connector	XS230BLPBL2	0.155
				XS230BLPBM12	0.085
NPN		Pre-cabled (L = 2 m) (1) M12 connector	XS230BLNBL2	0.155	
			XS230BLNBM12	0.085	
<b>Accessories (2)</b>					
Description				Reference	Weight kg
Fixing clamps			Ø 6.5	XSZB165	0.005
			Ø 8	XSZB108	0.006
			Ø 12	XSZB112	0.006
			Ø 18	XSZB118	0.010
			Ø 30	XSZB130	0.020

(1) For a 5 m long cable replace L2 by L5; for a 10 m long cable replace L2 by L10.

Example: XS118BLPAL2 becomes XS118BLPAL5 with a 5 m long cable.

(2) For further information, see page 128.

# Inductive proximity sensors

OsiSense XS, general purpose

Basic, cylindrical, metal, flush and non flush mountable

Two-wire AC

Three-wire DC, solid-state output

Characteristics		XS1●●BLP●L2 XS1●●BLN●L2	XS1●●BLP●M● XS1●●BLN●M●	XS2●●BLP●L2 XS2●●BLN●L2	XS2●●BLP●M● XS2●●BLN●M●	XS1●●BLFAL2
Sensor type		UL, CSA, CE				
Product certifications		UL, CSA, CE				
Connection	Pre-cabled	Length 2 m	–	Length 2 m	–	Length 2 m
	Connector	–	M8 on Ø 8 M12 on Ø 8, Ø 12, Ø 18 and Ø 30	–	M8 on Ø 8 M12 on Ø 8, Ø 12, Ø 18 and Ø 30	–
Operating zone (1)	Ø 6.5	mm	0...1.2	–	–	–
	Ø 8	mm	0...1.2	0...2	–	–
	Ø 12	mm	0...1.6	0...3.2	0...1.6	–
	Ø 18	mm	0...4	0...6.4	0...4	–
	Ø 30	mm	0...8	0...12	0...8	–
Differential travel		%				
Degree of protection		Conforming to IEC 60529				
Storage temperature		°C				
Operating temperature		°C				
Materials	Case	Nickel plated brass				
	Cable	PVC 3 x 0.34 mm <sup>2</sup> except Ø 6.5 and Ø 8: 3 x 0.11 mm <sup>2</sup>	–	PVC 3 x 0.34 mm <sup>2</sup> except Ø 6.5 and Ø 8: 3 x 0.11 mm <sup>2</sup>	–	PVC 2 x 0.34 mm <sup>2</sup>
Vibration resistance		Conforming to IEC 60068-2-6				
Shock resistance		Conforming to IEC 60068-2-27				
Output state indication		Yellow LED, on rear	Yellow LED: 4 viewing ports at 90°	Yellow LED, on rear	Yellow LED: 4 viewing ports at 90°	Yellow LED, on rear
Rated supply voltage		V				
Voltage limits (including ripple)		V				
Switching capacity		mA				
Voltage drop, closed state		V				
Current consumption, no-load		mA				
Residual current, open state		mA				
Maximum switching frequency	Ø 6.5, Ø 8	Hz				
	Ø 12	Hz				
	Ø 18	Hz				
	Ø 30	Hz				
Delays	First-up	ms				
	Response	ms				
	Recovery	ms				

(1) Detection curves, see page 132.

(2) These sensors do not incorporate overload or short-circuit protection and therefore, it is essential to connect a 0.4 A "quick-blow" fuse in series with the load, see page 128.

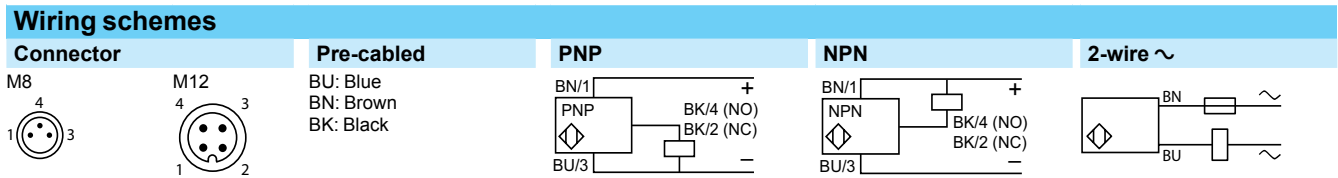

# Inductive proximity sensors

OsiSense XS, general purpose

Basic, cylindrical, metal, flush and non flush mountable

Two-wire AC

Three-wire DC, solid-state output

## Setting-up

### Minimum mounting distances (mm)

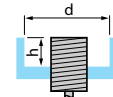
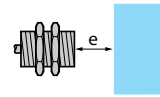
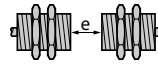
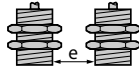

Sensors		Side by side	Face to face	Facing a metal object	Mounted in a metal support
Ø 6.5 flush mountable	XS106	$e \geq 3$	$e \geq 18$	$e \geq 4.5$	$d \geq 6.5$ $h \geq 0$
Ø 8 flush mountable	XS108	$e \geq 3$	$e \geq 18$	$e \geq 4.5$	$d \geq 8$ $h \geq 0$
Ø 8 non flush mountable	XS208	$e \geq 10$	$e \geq 30$	$e \geq 7.5$	$d \geq 24$ $h \geq 5$
Ø 12 flush mountable	XS112	$e \geq 4$	$e \geq 24$	$e \geq 6$	$d \geq 12$ $h \geq 0$
Ø 12 non flush mountable	XS212	$e \geq 16$	$e \geq 48$	$e \geq 12$	$d \geq 36$ $h \geq 8$
Ø 18 flush mountable	XS118	$e \geq 10$	$e \geq 60$	$e \geq 15$	$d \geq 18$ $h \geq 0$
Ø 18 non flush mountable	XS218	$e \geq 16$	$e \geq 96$	$e \geq 24$	$d \geq 54$ $h \geq 16$
Ø 30 flush mountable	XS130	$e \geq 20$	$e \geq 120$	$e \geq 30$	$d \geq 30$ $h \geq 0$
Ø 30 non flush mountable	XS230	$e \geq 60$	$e \geq 180$	$e \geq 45$	$d \geq 90$ $h \geq 30$

## Dimensions

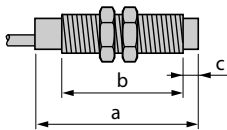

### Flush mountable in metal

Sensors		Pre-cabled (mm)		M8 connector (mm)			M12 connector (mm)	
		a	b	a	b	c	a	b
Ø 6.5	XS106	42	–	–	–	–	–	–
Ø 8	XS108	42	40	53	42	–	62	39
Ø 12	XS112	42	58 (1) 39	58 (1)	–	–	53	39
Ø 18	XS118	52	58 (1) 49	58 (1)	–	–	64	49
Ø 30	XS130	52	58 (1) 49	58 (1)	–	–	64	49

(1) For XS1●●BLFAL2

### Non flush mountable in metal

Sensors		Pre-cabled (mm)		M8 connector (mm)			M12 connector (mm)		
		a	b	a	b	c	a	b	c
Ø 8	XS208	42	36	53	38	4	62	36	4
Ø 12	XS212	42	34	–	–	–	53	34	5
Ø 18	XS218	51	41	–	–	–	64	41	8
Ø 30	XS230	51	36	–	–	–	64	36	13



# Inductive proximity sensors

OsiSense XS, general purpose

Cylindrical, almost flush mountable, increased range

Three-wire DC, solid-state output

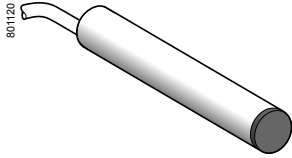

XS1L06●A349

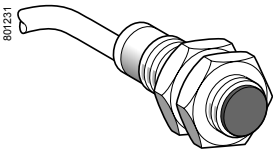

XS1N●●●●349

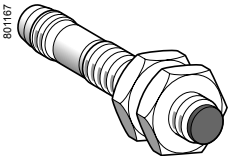

XS1N08●●349S

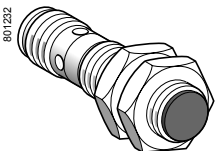

XS1N●●●●349D

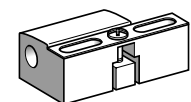

XSZB1●●

Sensing distance (Sn) (mm)	Function	Output	Connection	Reference	Weight kg
<b>Ø 6.5, plain</b>					
2.5	NO	PNP	Pre-cabled (L = 2 m)	XS1L06PA349	0.025
			M8 connector	XS1L06PA349S	0.010
			M12 connector	XS1L06PA349D	0.015
	NPN	Pre-cabled (L = 2 m)	XS1L06NA349	0.025	
		M8 connector	XS1L06NA349S	0.010	
		M12 connector	XS1L06NA349D	0.015	
NC	PNP	Pre-cabled (L = 2 m)	XS1L06PB349	0.025	
		M8 connector	XS1L06PB349S	0.010	
	NPN	Pre-cabled (L = 2 m)	XS1L06NB349	0.025	
		M8 connector	XS1L06NB349S	0.010	

<b>Ø 8, threaded M8 x 1</b>					
2.5	NO	PNP	Pre-cabled (L = 2 m)	XS1N08PA349	0.035
			M8 connector	XS1N08PA349S	0.015
			M12 connector	XS1N08PA349D	0.020
			Pre-cabled (L = 2 m)	XS1N08NA349	0.035
			M8 connector	XS1N08NA349S	0.015
			M12 connector	XS1N08NA349D	0.020
	NC	PNP	Pre-cabled (L = 2 m)	XS1N08PB349	0.035
			M8 connector	XS1N08PB349S	0.015
			M12 connector	XS1N08PB349D	0.020
			Pre-cabled (L = 2 m)	XS1N08NB349	0.035
			M8 connector	XS1N08NB349S	0.015
			M12 connector	XS1N08NB349D	0.020

<b>Ø 12, threaded M12 x 1</b>							
4	NO	PNP	Pre-cabled (L = 2 m)	XS1N12PA349	0.070		
			M12 connector	XS1N12PA349D	0.020		
			Pre-cabled (L = 2 m)	XS1N12NA349	0.070		
			M12 connector	XS1N12NA349D	0.020		
			NC	PNP	Pre-cabled (L = 2 m)	XS1N12PB349	0.070
					M12 connector	XS1N12PB349D	0.020
	Pre-cabled (L = 2 m)	XS1N12NB349			0.070		
	M12 connector	XS1N12NB349D			0.020		

<b>Ø 18, threaded M18 x 1</b>							
10	NO	PNP	Pre-cabled (L = 2 m)	XS1N18PA349	0.100		
			M12 connector	XS1N18PA349D	0.040		
			NPN	Pre-cabled (L = 2 m)	XS1N18NA349	0.100	
				M12 connector	XS1N18NA349D	0.040	
			NC	PNP	Pre-cabled (L = 2 m)	XS1N18PB349	0.100
					M12 connector	XS1N18PB349D	0.040
	NPN	Pre-cabled (L = 2 m)			XS1N18NB349	0.100	
		M12 connector			XS1N18NB349D	0.040	

<b>Ø 30, threaded M30 x 1.5</b>							
20	NO	PNP	Pre-cabled (L = 2 m)	XS1N30PA349	0.160		
			M12 connector	XS1N30PA349D	0.100		
			NPN	Pre-cabled (L = 2 m)	XS1N30NA349	0.160	
				M12 connector	XS1N30NA349D	0.100	
			NC	PNP	Pre-cabled (L = 2 m)	XS1N30PB349	0.160
					M12 connector	XS1N30PB349D	0.100
	NPN	Pre-cabled (L = 2 m)			XS1N30NB349	0.160	
		M12 connector			XS1N30NB349D	0.100	

<b>Accessories (1)</b>					
Description mm		Reference	Weight kg		
Fixing clamps	Ø 6.5 (plain)	XSZB165	0.005		
	Ø 8	XSZB108	0.006		
	Ø 12	XSZB112	0.006		
	Ø 18	XSZB118	0.010		
	Ø 30	XSZB130	0.020		

(1) For further information, see page 128.

# Inductive proximity sensors

OsiSense XS, general purpose

Cylindrical, almost flush mountable, increased range

Three-wire DC, solid-state output

Characteristics		XS1.....349D	XS1.....349S	XS1.....349
Sensor type		UL, CSA, CE		
Product certifications		M12 connector		
Connection		M12 connector	M8 connector	Pre-cabled, length: 2 m
Operating zone	Ø 6.5 and Ø 8	mm	0...2	
	Ø 12	mm	0...3.2	
	Ø 18	mm	0...8	
	Ø 30	mm	0...16	
Differential travel		%	1...15 of effective sensing distance (Sr)	
Degree of protection	Conforming to IEC 60529	IP 67		IP 68, double insulation (except Ø 6.5 and Ø 8: IP 67)
	Conforming to DIN 40050	IP 69K for Ø 12 to Ø 30		
Storage temperature		°C	- 40...+ 85	
Operating temperature		°C	- 25...+ 70	
Materials	Case	Nickel plated brass		
	Cable	-		
Vibration resistance		Conforming to IEC 60068-2-6	25 gn, amplitude ± 2 mm (f = 10 to 55 Hz)	
Shock resistance		Conforming to IEC 60068-2-27	50 gn, duration 11 ms	
Output state indication		Yellow LED, 4 viewing ports at 90°		Yellow LED, annular
Rated supply voltage		V	12...24 with protection against reverse polarity	
Voltage limits (including ripple)		V	10...36	
Switching capacity		mA	≤ 200 with overload and short-circuit protection	
Voltage drop, closed state		V	≤ 2	
Current consumption, no-load		mA	≤ 10	
Maximum switching frequency	Ø 6.5, Ø 8 and Ø 12	Hz	2500	
	Ø 18	Hz	1000	
	Ø 30	Hz	500	
Delays	First-up	ms	≤ 5	
	Response	ms	≤ 0.2 for Ø 8 and Ø 12, ≤ 0.3 for Ø 18, ≤ 0.6 for Ø 30	
	Recovery	ms	≤ 0.2 for Ø 8 and Ø 12, ≤ 0.7 for Ø 18, ≤ 1.4 for Ø 30	

## Wiring schemes

Connector	Pre-cabled	PNP 3-wire	NPN 3-wire
M8	BU: Blue BN: Brown BK: Black		
M12			

For M8 connector, NO and NC outputs on terminal 4

## Setting-up precautions

Sensor	Minimum mounting distances (mm)			
	Side by side	Face to face	Facing a metal object	Mounted in a metal support
Ø 6.5	e ≥ 5	e ≥ 30	e ≥ 7.5	d ≥ 10 h ≥ 1.6
Ø 8	e ≥ 5	e ≥ 30	e ≥ 7.5	d ≥ 10 h ≥ 1.6
Ø 12	e ≥ 8	e ≥ 48	e ≥ 12	d ≥ 14 h ≥ 2.4
Ø 18	e ≥ 20	e ≥ 96	e ≥ 30	d ≥ 28 h ≥ 3.6
Ø 30	e ≥ 40	e ≥ 240	e ≥ 60	d ≥ 50 h ≥ 6

## Dimensions

Sensor	Flush mountable in metal					
	Pre-cabled		M8 connector		M12 connector	
	a	b	a	b	a	b
Ø 6.5	33	-	42	-	45	-
Ø 8	33	25	42	26	45	23
Ø 12	35	25	-	-	50	30
Ø 18	39	28	-	-	50	28
Ø 30	43	32	-	-	55	32

# Inductive proximity sensors

OsiSense XS, general purpose

Miniature, cylindrical, flush and non flush mountable

Three-wire DC, solid-state output

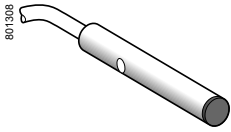

XS1L04●●310

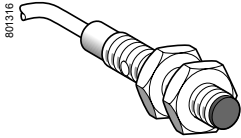

XS1N05●●310

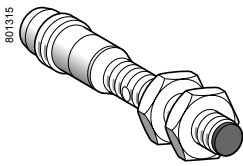

XS1N05●●311S

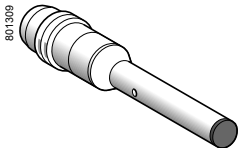

XS1L04●●310S

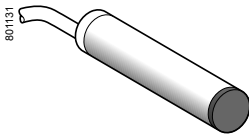

XS●L06●●340

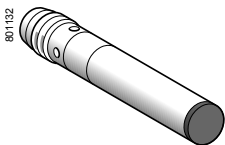

XS●L06●●340S  
XS●L06●●349S

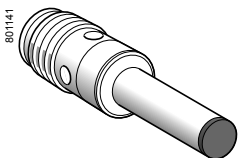

XS●L06●●340D

## Ø 4 plain (1)

Sensing distance (Sn) mm	Function	Output	Connection (2)	Reference	Weight kg
<b>Brass case, flush mountable</b>					
1	NO	PNP	Pre-cabled (L = 2 m)	<b>XS1L04PA310</b>	0,025
			M8 connector	<b>XS1L04PA310S</b>	0.010
	NPN	PNP	Pre-cabled (L = 2 m)	<b>XS1L04NA310</b>	0.025
			M8 connector	<b>XS1L04NA310S</b>	0.010
	NC	PNP	Pre-cabled (L = 2 m)	<b>XS1L04PB310</b>	0.025
			M8 connector	<b>XS1L04PB310S</b>	0.010
NPN	PNP	Pre-cabled (L = 2 m)	<b>XS1L04NB310</b>	0.025	
		M8 connector	<b>XS1L04NB310S</b>	0.010	

## Stainless steel case, flush mountable

0,8	NO	PNP	Pre-cabled (L = 2 m)	<b>XS1L04PA311</b>	0.025
			M8 connector	<b>XS1L04PA311S</b>	0.010
	NPN	PNP	Pre-cabled (L = 2 m)	<b>XS1L04NA311</b>	0.025
			M8 connector	<b>XS1L04NA311S</b>	0.010
	NC	PNP	Pre-cabled (L = 2 m)	<b>XS1L04PB311</b>	0.025
			M8 connector	<b>XS1L04PB311S</b>	0.010
NPN	PNP	Pre-cabled (L = 2 m)	<b>XS1L04NB311</b>	0.025	
		M8 connector	<b>XS1L04NB311S</b>	0.010	

## Ø 5, threaded M5 x 0.5 (1)

Sensing distance (Sn) mm	Function	Output	Connection (2)	Reference	Weight kg
<b>Brass case, flush mountable</b>					
1	NO	PNP	Pre-cabled (L = 2 m)	<b>XS1N05PA310</b>	0,030
			NPN	Pre-cabled (L = 2 m)	<b>XS1N05NA310</b>
	NC	PNP	Pre-cabled (L = 2 m)	<b>XS1N05PB310</b>	0,030
			NPN	Pre-cabled (L = 2 m)	<b>XS1N05NB310</b>

## Stainless steel case, flush mountable

0.8	NO	PNP	Pre-cabled (L = 2 m)	<b>XS1N05PA311</b>	0.030
			M8 connector	<b>XS1N05PA311S</b>	0.015
	NPN	PNP	Pre-cabled (L = 2 m)	<b>XS1N05NA311</b>	0.030
			M8 connector	<b>XS1N05NA311S</b>	0.015
	NC	PNP	Pre-cabled (L = 2 m)	<b>XS1N05PB311</b>	0.030
			M8 connector	<b>XS1N05PB311S</b>	0.015
NPN	PNP	Pre-cabled (L = 2 m)	<b>XS1N05NB311</b>	0.030	
		M8 connector	<b>XS1N05NB311S</b>	0.015	

## Ø 6.5 plain (1)

Sensing distance (Sn) mm	Function	Output	Connection (2)	Reference	Weight kg	
<b>Stainless steel case, non flush mountable</b>						
2.5	NO	PNP	Pre-cabled (L = 2 m)	<b>XS2L06PA340</b>	0.025	
			M8 connector	<b>XS2L06PA340S</b>	0.010	
			M12 connector	<b>XS2L06PA340D</b>	0.015	
			NPN	Pre-cabled (L = 2 m)	<b>XS2L06NA340</b>	0.025
				M8 connector	<b>XS2L06NA340S</b>	0.010
				M12 connector	<b>XS2L06NA340D</b>	0.015
	NC	PNP	Pre-cabled (L = 2 m)	<b>XS2L06PB340</b>	0.025	
			M8 connector	<b>XS2L06PB340S</b>	0.010	
			M12 connector	<b>XS2L06PB340D</b>	0.015	
			NPN	Pre-cabled (L = 2 m)	<b>XS2L06NB340</b>	0.025
				M8 connector	<b>XS2L06NB340S</b>	0.010
				M12 connector	<b>XS2L06NB340D</b>	0.015

(1) For accessories, see page 128.

(2) For a 5 m long cable add L1 to the reference; for a 10 m long cable add L2 to the reference.

Example: XS1L04PA310 becomes XS1L04PA310L1 with a 5 m long cable.

# Inductive proximity sensors

OsiSense XS, general purpose



Miniature, cylindrical, flush and non flush mountable

Three-wire DC, solid-state output

Characteristics		XS1●●●●●●●●S, XS1●●●●●●●●D, XS2L06●A340●	XS1●●●●●●●●, XS2L06●A340
Sensor type			
Product certifications		UL, CSA, CE	
Connection (1)	Connector	M8 on XS1●●●●●●●●S and M12 on XS1●●●●●●●●D	–
	Pre-cabled	–	Length: 2 m
Operating zone	∅ 4	mm	0...0.8 (brass), 0...0.6 (stainless steel)
	∅ 5	mm	0...0.8 (brass), 0...0.6 (stainless steel)
	∅ 6.5 non flush mountable	mm	0...2 (stainless steel)
Degree of protection	Conforming to IEC 60529	IP 67	
Storage temperature		°C	- 40...+ 85
Operating temperature		°C	- 25...+ 70
Materials	Case	Nickel plated brass or stainless steel, grade 303	
	Cable	PvR 3 x 0.11 mm <sup>2</sup> or 4 x 0.08 mm <sup>2</sup>	
Vibration resistance	Conforming to IEC 60068-2-6	25 gn, amplitude ± 2 mm (f = 10 to 55 Hz)	
Shock resistance	Conforming to IEC 60068-2-27	50 gn, duration 11 ms	
Output state indication		Yellow LED, 4 viewing ports at 90°	Yellow LED, annular
Rated supply voltage		V	--- 5...24 for XS1L04●●●●●●●● and XS1N05●●●●●●●● --- 12...24 for XS2L06●●●●●●●●
Voltage limits (including ripple)		V	--- 5...30 for XS1L04●●●●●●●● and XS1N05●●●●●●●● --- 10...38 for XS2L06●●●●●●●●
Current consumption, no-load		mA	≤ 10
Switching capacity	3-wire PNP/NPN	mA	≤ 100 with overload and short-circuit protection ≤ 200 for XS2L06 with overload and short-circuit protection
Voltage drop, closed state		V	≤ 2
Maximum switching frequency		kHz	5
Delays	First-up	ms	≤ 5
	Response	ms	≤ 0.1
	Recovery	ms	≤ 0.1

(1) Detection curves, see page 132

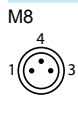

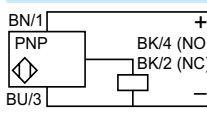
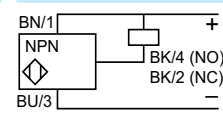
## Wiring schemes

Connector	Pre-cabled	PNP 3-wire	NPN 3-wire
M8 	M12 		
	BU: Blue BN: Brown BK: Black WH: White		

For M8 connector, NO and NC outputs on terminal 4.

## Setting-up

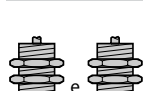
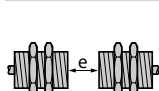
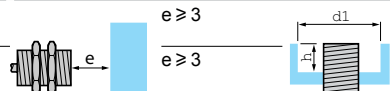
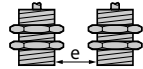
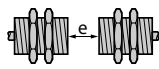
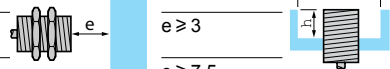
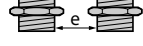
### Minimum mounting distances (mm)

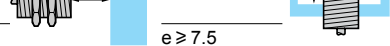
Sensor	Side by side	Face to face	Facing a metal object
∅ 4	 e ≥ 2	 e ≥ 12	 e ≥ 3, d1 ≥ 4, h ≥ 0
∅ 5	 e ≥ 2	 e ≥ 12	 e ≥ 3, d1 ≥ 5, h ≥ 0
∅ 6.5	 e ≥ 5	 e ≥ 30	 e ≥ 7.5, d1 ≥ 10, h ≥ 4

### Tightening torque

Stainless steel: 2.2 N.m. Brass: 1.6 N.m (values obtained with washers mounted)

## Dimensions

Sensor	Pre-cabled			M8 connector			M12 connector		
	a	b	c	a	b	c	a	b	c
∅ 4	29	–	–	41	–	–	–	–	–
∅ 5	29	24	–	41	24	–	–	–	–
∅ 6.5	33	–	4	46	–	4	49	–	4

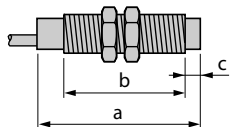

# Inductive proximity sensors

OsiSense XS Application

Adjustable range sensors

Cylindrical, flush mountable and non flush mountable

Three-wire DC, solid-state output

520030

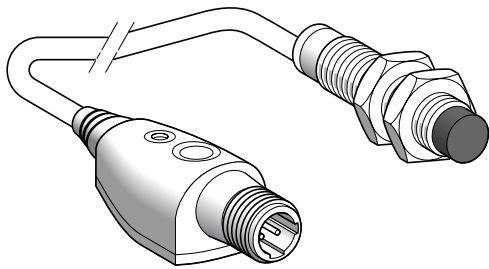

XS6●●B2●●L01M12

## Ø 12, threaded M12 x 1

Sensing distance (Sn) mm	Function	Output	Connection	Reference	Weight kg
5	NO	PNP	Remote M12 connector on 0.15 m flying lead	<b>XS612B2PAL01M12</b>	0.100
		NPN	Remote M12 connector on 0.15 m flying lead	<b>XS612B2NAL01M12</b>	0.100
	NC	PNP	Remote M12 connector on 0.15 m flying lead	<b>XS612B2PBL01M12</b>	0.100
		NPN	Remote M12 connector on 0.15 m flying lead	<b>XS612B2NBL01M12</b>	0.100

## Ø 18, threaded M18 x 1

Sensing distance (Sn) mm	Function	Output	Connection	Reference	Weight kg
9	NO	PNP	Remote M12 connector on 0.15 m flying lead	<b>XS618B2PAL01M12</b>	0.140
		NPN	Remote M12 connector on 0.15 m flying lead	<b>XS618B2NAL01M12</b>	0.140
	NC	PNP	Remote M12 connector on 0.15 m flying lead	<b>XS618B2PBL01M12</b>	0.140
		NPN	Remote M12 connector on 0.15 m flying lead	<b>XS618B2NBL01M12</b>	0.140

520031

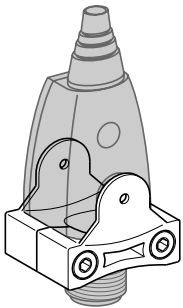

XSZBPM12

## Ø 30, threaded M30 x 1.5

Sensing distance (Sn) mm	Function	Output	Connection	Reference	Weight kg
18	NO	PNP	Remote M12 connector on 0.15 m flying lead	<b>XS630B2PAL01M12</b>	0.220
		NPN	Remote M12 connector on 0.15 m flying lead	<b>XS630B2NAL01M12</b>	0.220
	NC	PNP	Remote M12 connector on 0.15 m flying lead	<b>XS630B2PBL01M12</b>	0.220
		NPN	Remote M12 connector on 0.15 m flying lead	<b>XS630B2NBL01M12</b>	0.220

825994

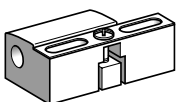

XSZB●●●

## Accessories (1)

Description	Reference	Weight kg
Remote control fixing clamp	<b>XSZBPM12</b>	0.015
Sensor fixing clamps	Ø 12	<b>XSZB112</b>
	Ø 18	<b>XSZB118</b>
	Ø 30	<b>XSZB130</b>

(1) For further information, see page 128.

# Inductive proximity sensors

OsiSense XS Application

Adjustable range sensors

Cylindrical, flush mountable and non flush mountable

Three-wire DC, solid-state output

Characteristics		XS6●●B2●●L01M12	
Sensor type		UL, CSA, CE	
Product certifications		Remote M12 connector on 0.15 m flying lead	
Connection	Connector	Remote M12 connector on 0.15 m flying lead	
Sensing distance and adjustment zone	Ø 12	Nominal sensing distance (Sn)	mm 0...5 non flush mounted / 0...3.4 flush mounted
		Precision adjustment zone	mm 1.7...5 non flush mounted / 1.7...3.4 flush mounted
	Ø 18	Nominal sensing distance (Sn)	mm 0...9 non flush mounted / 0...6 flush mounted
		Precision adjustment zone	mm 3...9 non flush mounted / 3...6 flush mounted
	Ø 30	Nominal sensing distance (Sn)	mm 0...18 non flush mounted / 0...11 flush mounted
		Precision adjustment zone	mm 6...18 non flush mounted / 6...11 flush mounted
Differential travel		% 1...15 of effective sensing distance (Sr)	
Degree of protection		Conforming to IEC 60529 IP 67, $\square$	
Storage temperature		°C - 40...+ 85	
Operating temperature		°C - 25...+ 70	
Materials	Case	Nickel plated brass	
	Remote control	PBT	
	Cable	PvR - Ø 4.2 mm	
Vibration resistance		Conforming to IEC 60068-2-6 25 gn, amplitude ± 2 mm (f = 10 to 55 Hz)	
Shock resistance		Conforming to IEC 60068-2-27 50 gn, duration 11 ms	
Indicators	Output state	Yellow LED	
	Supply on and teach mode	Green LED	
Rated supply voltage		V --- 12...24 with protection against reverse polarity	
Voltage limits (including ripple)		V --- 10...36	
Switching capacity		mA ≤ 100 with overload and short-circuit protection	
Voltage drop, closed state		V ≤ 2	
Current consumption, no-load		mA ≤ 10	
Maximum switching frequency		Hz 1000	
Delays	First-up	ms ≤ 10	
	Response	ms ≤ 0.3	
	Recovery	ms ≤ 0.7	

## Wiring schemes

Connector	PNP	NPN
M12 		

## Setting-up

### Minimum mounting distances (mm)

	Side by side		Face to face		Facing a metal object
	flush mounted	not flush mounted	flush mounted	not flush mounted	
Ø 12	e ≥ 14	50	e ≥ 50	100	e ≥ 3.4
Ø 18	e ≥ 28	100	e ≥ 100	200	e ≥ 6
Ø 30	e ≥ 48	180	e ≥ 180	360	e ≥ 11

## Dimensions

### XS6

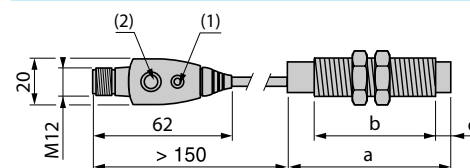

(1) LED  
(2) Teach mode button

	Connector (mm)		
	a	b	c
Ø 12	54.6	42	5
Ø 18	60	44	8
Ø 30	62.6	41	13



# Inductive proximity sensors

OsiSense XS, general purpose with increased range

Flat, flush mountable/non flush mountable + teach mode (1)

Two-wire AC or DC

Three-wire DC, solid-state output

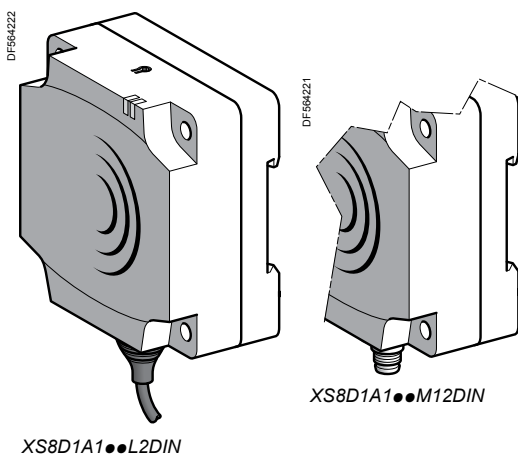
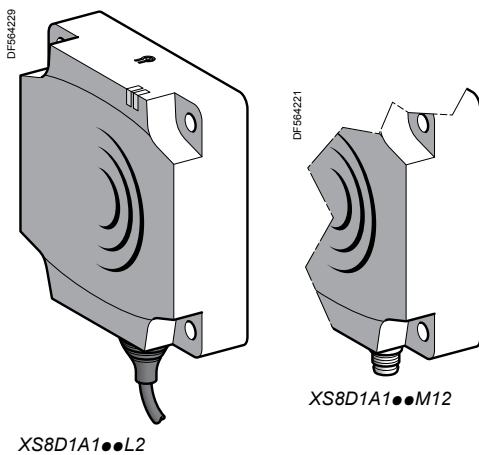
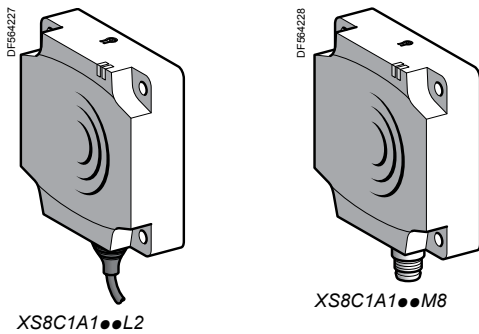
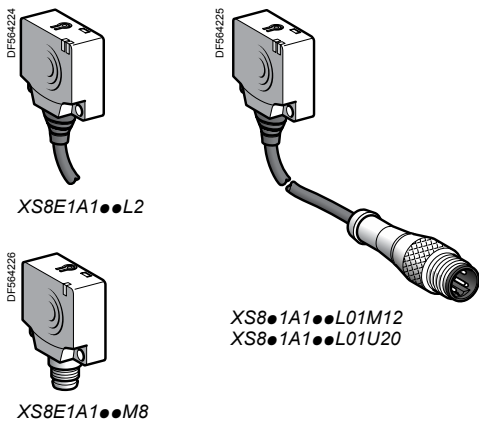

## Flat, 26 x 26 x 13 mm format (2)

Sensing distance (Sn) mm	Function	Output	Connection	Reference	Weight kg
15	NO	PNP	Pre-cabled (L = 2 m) (3)	XS8E1A1PAL2	0.075
			M8 connector	XS8E1A1PAM8	0.040
			Remote M12 connector	XS8E1A1PAL01M12	0.040
		NPN	Pre-cabled (L = 2 m) (3)	XS8E1A1NAL2	0.075
			M8 connector	XS8E1A1NAM8	0.040
			Remote M12 connector	XS8E1A1NAL01M12	0.040
	NC	PNP	Pre-cabled (L = 2 m) (3)	XS8E1A1PBL2	0.075
			M8 connector	XS8E1A1PBM8	0.040
			Remote M12 connector	XS8E1A1PBL01M12	0.040
		NPN	Pre-cabled (L = 2 m) (3)	XS8E1A1NBL2	0.075
			M8 connector	XS8E1A1NBM8	0.040
			Remote M12 connector	XS8E1A1NBL01M12	0.040

## Two-wire ~ or ⋯ unprotected (4)

15	NO	-	Pre-cabled (L = 2 m) (3)	XS8E1A1MAL2	0.070
			Remote 1/2"-20UNF connector	XS8E1A1MAL01U20	0.040
	NC	-	Pre-cabled (L = 2 m) (3)	XS8E1A1MBL2	0.070
			Remote 1/2"-20UNF connector	XS8E1A1MBL01U20	0.040

## Flat, 40 x 40 x 15 mm format (2)

Sensing distance (Sn) mm	Function	Output	Connection	Reference	Weight kg
25	NO	PNP	Pre-cabled (L = 2 m) (3)	XS8C1A1PAL2	0.095
			M8 connector	XS8C1A1PAM8	0.060
			Remote M12 connector	XS8C1A1PAL01M12	0.060
		NPN	Pre-cabled (L = 2 m) (3)	XS8C1A1NAL2	0.095
			M8 connector	XS8C1A1NAM8	0.060
			Remote M12 connector	XS8C1A1NAL01M12	0.060
	NC	PNP	Pre-cabled (L = 2 m) (3)	XS8C1A1PBL2	0.095
			M8 connector	XS8C1A1PBM8	0.060
			Remote M12 connector	XS8C1A1PBL01M12	0.060
		NPN	Pre-cabled (L = 2 m) (3)	XS8C1A1NBL2	0.095
			M8 connector	XS8C1A1NBM8	0.060
			Remote M12 connector	XS8C1A1NBL01M12	0.060

## Two-wire ~ or ⋯ unprotected (4)

25	NO	-	Pre-cabled (L = 2 m) (3)	XS8C1A1MAL2	0.090
			Remote 1/2"-20UNF connector	XS8C1A1MAL01U20	0.060
	NC	-	Pre-cabled (L = 2 m) (3)	XS8C1A1MBL2	0.090
			Remote 1/2"-20UNF connector	XS8C1A1MBL01U20	0.060

## Flat, 80 x 80 x 26 mm format (2)

Sensing distance (Sn) mm	Function	Output	Connection	Reference	Weight kg		
60	NO	PNP	Pre-cabled (L = 2 m) (3)	XS8D1A1PAL2 (5)	0.390		
			M12 connector	XS8D1A1PAM12 (5)	0.340		
			Pre-cabled (L = 2 m) (3)	XS8D1A1NAL2 (5)	0.390		
		NPN	M12 connector	XS8D1A1NAM12 (5)	0.340		
			NC	PNP	Pre-cabled (L = 2 m) (3)	XS8D1A1PBL2 (5)	0.390
					M12 connector	XS8D1A1PBM12 (5)	0.340
	Pre-cabled (L = 2 m) (3)	XS8D1A1NBL2 (5)			0.390		
	NPN	M12 connector	XS8D1A1NBM12 (5)	0.340			

## Two-wire ~ or ⋯ unprotected (4)

60	NO	-	Pre-cabled (L = 2 m) (3)	XS8D1A1MAL2 (5)	0.390
			1/2"-20UNF connector	XS8D1A1MAU20 (5)	0.340
	NC	-	Pre-cabled (L = 2 m) (3)	XS8D1A1MBL2 (5)	0.390
			1/2"-20UNF connector	XS8D1A1MBU20 (5)	0.340

(1) For further information on flush or non flush mountable sensors using teach mode, see page 22.

(2) For accessories, see page 128.

(3) For a 5 m long cable replace L2 by L5; for a 10 m long cable replace L2 by L10.

(4) It is essential to connect a 0.4 A "quick-blow" fuse in series with the load.

(5) For clipping onto 35 mm omega rail or 80 x 80 x 40 mm format, add DIN to the end of the reference. Example: XS8D1A1PAL2 DIN.



Characteristics		XS8E●●●●●M8, XS8C●●●●●M8, XS8D●●●●●M12, XS8D●●●●●U20	XS8E●●●●●L01M12, XS8E●●●●●L01U20, XS8C●●●●●L01M12, XS8C●●●●●L01U20	XS8E●●●●●L2, XS8C●●●●●L2, XS8D●●●●●L2
Sensor type				
Product certifications		UL, CSA, CE		
Connection	Connector	M8 except XS8●●●●●M12: M12 XS8●●●●●U20: 1/2"-20UNF	Remote on 0.15 m flying lead XS8●●●●●L01M12: M12 XS8●●●●●L01U20: 1/2"-20UNF	–
	Pre-cabled	–	–	Length: 2 m
Sensing distance and adjustment zone	XS8E	Nominal sensing dist. Sn	mm 0...15 not flush mounted / 0...10 flush mounted	
		Fine adjustment zone	mm 5...15 not flush mounted / 5...10 flush mounted	
	XS8C	Nominal sensing dist. Sn	mm 0...25 not flush mounted / 0...15 flush mounted	
		Fine adjustment zone	mm 8...25 not flush mounted / 8...15 flush mounted	
XS8D	Nominal sensing dist. Sn	mm 0...60 not flush mounted / 0...40 flush mounted		
	Fine adjustment zone	mm 20...60 not flush mounted / 20...40 flush mounted		
Differential travel		%		
Degree of protection	Conforming to IEC 60529	IP 67, double insulation □ (except M8 connector: IP 67)		IP 68, □
Storage temperature		°C -40...+85		
Operating temperature		°C -25...+70		
Materials	Case	PBT		
	Cable	–	PvR 3 x 0.34 mm <sup>2</sup> ≡ and PvR 2 x 0.34 mm <sup>2</sup> ≡	
Vibration resistance	Conforming to IEC 60068-2-6	25 gn, amplitude ± 2 mm (f = 10 to 55 Hz)		
Shock resistance	Conforming to IEC 60068-2-27	50 gn, duration 11 ms		
Indicators	Output state	Yellow LED		
	Supply on and teach mode	Green LED		
Rated supply voltage	3-wire	V 12...24 with protection against reverse polarity		
	2-wire	V ~ or ≡ 24...240 (~ 50/60 Hz)		
Voltage limits (including ripple)	3-wire	V 10...36		
	2-wire	V ~ or ≡ 20...264		
Current consumption, no-load	3-wire	mA ≤ 10		
Residual current, open state	2-wire	mA ≤ 1.5		
Switching capacity	3-wire	mA ≤ 100 XS8E, ≤ 200 XS8C and XS8D, with overload and short-circuit protection		
	2-wire	mA 5...200 ≡ XS8E, 5...300 ~ XS8C and XS8D, 5...200 ≡ XS8C and XS8D		
Voltage drop, closed state	3-wire	V ≤ 2		
	2-wire	V ≤ 5.5		
Maximum switching frequency		Hz 2000 XS8E, 1000 XS8C, 150 XS8D		
Delays	First-up	ms ≤ 10 XS8E, XS8C and XS8D (3-wire), ≤ 10 XS8E and XS8C, ≤ 15 XS8D (2-wire)		
	Response	ms ≤ 0.3		
	Recovery	ms ≤ 0.8 XS8E and XS8C, ≤ 6 XS8D		

## Wiring schemes

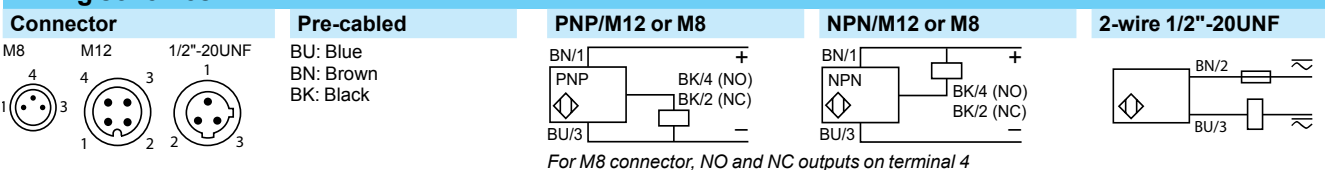

## Setting-up

Minimum mounting distances (mm)		XS8E	XS8C	XS8D
Side by side	Flush mounted	40	60	200
	Not flush mounted	150	125	600
Face to face	Flush mounted	80	120	400
	Not flush mounted	300	250	not recommended
	Facing a metal object	10	15	40

## Dimensions

Sensor	A (cable)	A (connector)	B	C	D	E	F	G	H
XS8E	14	11	26	13	8.8	20	3.5	6.8	6.6
XS8C	14	11	40	15	9.8	33	4.5	8.3	13.6
XS8D	23	18	80	26	16	65	5.5	8.5	37.8
XS8D●●DIN	23	18	80	40	30	65	5.1	22.5	37.8

# Inductive proximity sensors

## OsiSense XS Application

Sensors for rotation monitoring, slip detection, shaft overload detection  
Cylindrical form

**Example:**  
Coupling breakage monitoring

822138

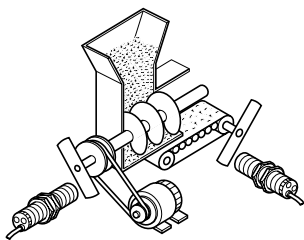

822145

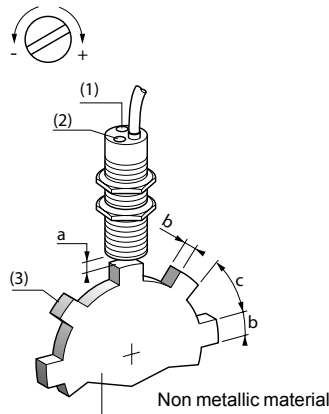

### Functions

These self-contained rotation speed monitoring sensors have the special feature of incorporating, in the same case, the pulse sensing and processing electronics as well as the output switching amplifier that are required to establish an integrated rotation monitoring device.

The unit provides an economical solution for detecting slip, belt breakage, drive shaft shear and overloading, etc., in the following applications: conveyor belts, bucket elevators, Archimedian screws, grinders, crushers, pumps, centrifugal driers, mixers, etc.

### Operating principle

The output signal of this type of sensor is processed by an impulse comparator incorporated in the sensor. The impulse frequency  $F_c$  generated by the moving part to be monitored is compared to the frequency  $F_r$  preset on the sensor. The output switching circuit of the sensor is in the closed state for  $F_c > F_r$  and the open state for  $F_c < F_r$ .

Sensors XSAV are particularly suitable for the detection of underspeed: when the speed of the moving part  $F_c$  falls below a preset threshold  $F_r$ , this causes the output circuit of the sensor to switch off.

**Note:** Following power-up, the operational status of the sensor is subject to a delay of 9 seconds in order for the moving part being monitored to run-up to its nominal speed. During this time, the output of the sensor remains in the closed state.

### Adjustment of frequency threshold

- Adjustment of sensor's frequency threshold: using potentiometer, 15 turns approximately.
- To increase the frequency threshold: turn the adjustment screw clockwise (+).
- To decrease the frequency threshold: turn the adjustment screw anti-clockwise (-).

Potentiometer	Diameter of sensor			
LED	a	b	c	
Metal target	M30	4...6 mm	30 mm	60 mm

### Potentiometer adjustment curves (for XSAV1●801, 2-wire ~ or - sensors)

Low speed version (6...150 impulses/minute)      High speed version (120...3000 impulses/minute)

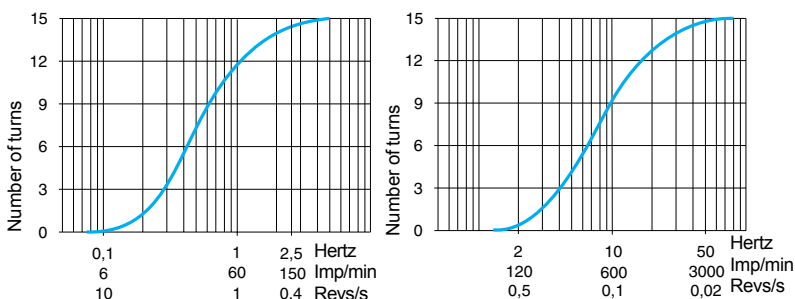

### Setting-up

#### Minimum distances (mm)

Side by side

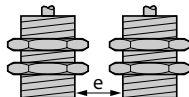

$e \geq 20$

Facing a metal object

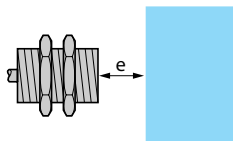

$e \geq 30$

Fixing nut tightening torque: < 50 N.m

Face to face

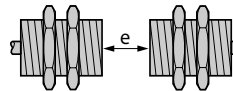

$e \geq 120$

Mounted in a metal support

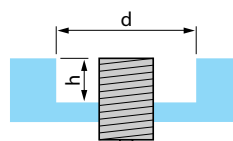

$d \geq 30, h \geq 0$

# Inductive proximity sensors

## OsiSense XS Application

Sensors for rotation monitoring, slip detection, shaft  
overload detection

Cylindrical form

### Sensor Flush mountable in metal

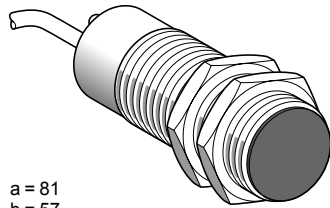
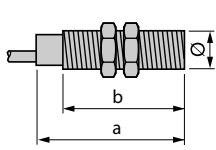

Lengths (mm):

a = Overall

b = Threaded section

a = 81

b = 57

Ø = M30

	DC	DC	AC/DC	AC/DC
Nominal sensing distance (Sn)	10 mm	10 mm	10 mm	10 mm
Adjustable frequency range	6...150 impulses/min	120...3000 impulses/min	6...150 impulses/min	120...3000 impulses/min

### References

3-wire $\overline{\text{---}}$	PNP / NC	XSAV11373	XSAV12373	–	–
2-wire $\overline{\text{---}}$ or $\sim$ / NC	–	–	–	XSAV11801	XSAV12801
Weight (kg)	0.300				

### Characteristics

Connection	Pre-cabled, 3 x 0.34 mm <sup>2</sup> , length 2 m (1)	Pre-cabled, 2 x 0.34 mm <sup>2</sup> , length 2 m (1)
Degree of protection conforming to IEC 60529	IP 67	
Operating zone	0...8 mm	
Repeat accuracy	3 % of Sr	
Differential travel	3...15 % of Fr	
Operating temperature	-25...+70 °C	
Output state indication	Red LED	
Rated supply voltage	$\overline{\text{---}}$ 12...48 V with protection against reverse polarity	$\sim$ 24...240 V (50/60 Hz) or $\overline{\text{---}}$ 24...210 V
Voltage limits (including ripple)	$\overline{\text{---}}$ 10...58 V	$\sim$ or $\overline{\text{---}}$ 20...264 V
Switching capacity	≤ 200 mA with overload and short-circuit protection	$\sim$ 5...350 mA or $\overline{\text{---}}$ 5...200 mA (2)
Voltage drop, closed state	≤ 1.8 V	≤ 5.7 V
Residual current, open state	–	≤ 1.5 mA
Current consumption, no-load	≤ 15 mA	–
Maximum switching frequency	6000 impulses/min (for XSAV11●●●); 48,000 impulses/min (for XSAV12●●●)	
“Run-up” delay following power-up	9 seconds ± 20 % + 1/Fr (3)	

### Wiring schemes

3-wire  $\overline{\text{---}}$   
XSAV1●373

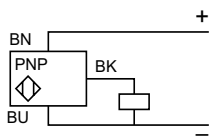

2-wire  $\sim$  or  $\overline{\text{---}}$   
XSAV1●801

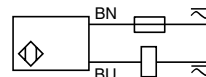

(1) For a 5 m long cable add L05 to the reference, for a 10 m long cable add L10 to the reference.

Example: XSAV11373 becomes XSAV11373L05 with a 5 m long cable.

(2) These sensors do not incorporate overload or short-circuit protection and therefore, it is essential to connect a 0.4 A “quick-blow” fuse in series with the load, see page 128.

(3) For a sensor without a “run-up” delay following power-up, replace XSAV1 in the reference by XSAV0. Example: XSAV11801 becomes XSAV01801 without a “run-up” delay. For a reduced “run-up” delay of 3 s, replace XSAV1 in the reference by XSAV3.

# Inductive proximity sensors

## OsiSense XS Application

Sensors for rotation monitoring, slip detection and shaft overload detection, with teach mode

### Operating principle and applications

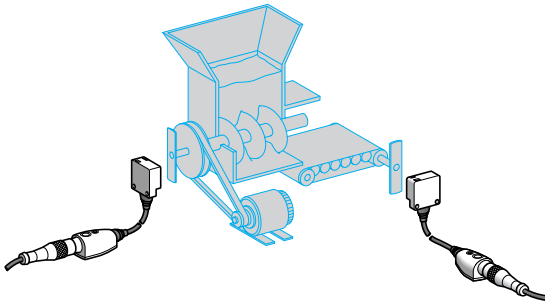

- These inductive proximity sensors are designed for monitoring rotational speed or the speed of the flow of objects to be protected or monitored. They operate on the principle of comparing a speed threshold preset by the operator against the instantaneous measurement of the speed of the moving object to be protected.
- They provide a simple, economical solution for detecting slip, belt breakage, coupling breakage and overload, etc.
- They are widely used in grinder/crusher, mixer, pump, centrifugal driver, conveyor belt, bucket elevator, Archimedeian screw, etc. type applications.

### Installation and setting-up

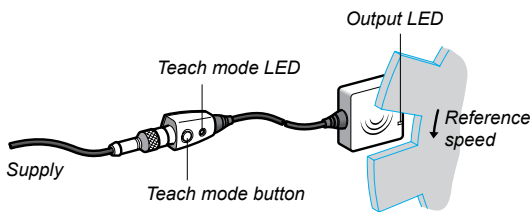

#### Setting-up and positioning the sensor

- In the positioning phase, the XS9 sensor can operate as a standard inductive sensor (Schneider Electric patent). Operation in inductive mode enables validation of reliable detection of all the moving objects to be monitored.
- Using this system, the positioning is therefore made 100 % reliable and can be checked at any time without altering the settings of the sensor.

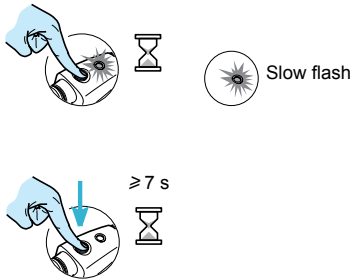

#### Speed adjustment in teach mode

- The normal or reference speed of the moving object (1) to be monitored is adjusted by simply pressing the teach mode button (2) and is then validated by the display LED.
- If in doubt, the sensor can be reset at any time to the factory settings.
- (1) To allow the moving object to reach its normal speed (machine inertia), the sensor holds its output closed for 9 seconds.
- (2) The sensor's default drop-out underspeed corresponds to the preset speed - 30 %.  
Example: If the preset speed is 1000 rpm, the sensor drops out on underspeed when the speed of the moving object drops below  $1000 - (1000 \times 0.3) = 700$  rpm.  
- 20 %, - 11 % and - 6 % thresholds can be obtained by pressing the teach mode button.

### Setting-up

#### Minimum mounting distances (mm)

Type	Side by side	Face to face
XS9E	$e \geq 40$	$e \geq 80$
XS9C	$e \geq 60$	$e \geq 120$

### Dimensions

#### XS9E, XS9C

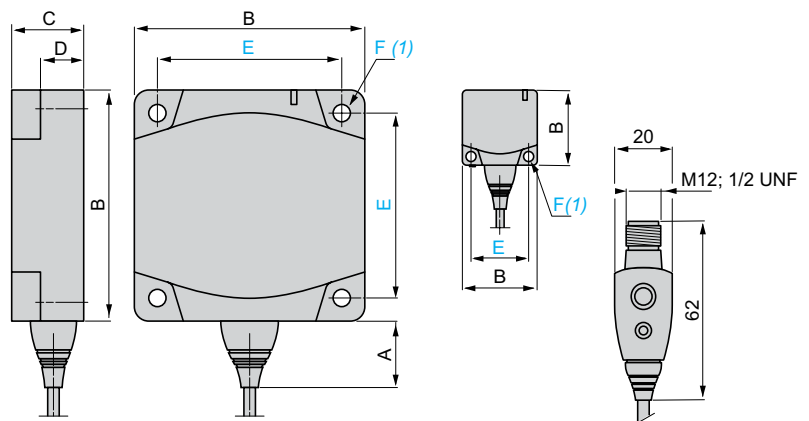

(1) For CHC type screws

Type	A	B	C	D	E	F
XS9E	14	26	13	8.8	20	3.5
XS9C	14	40	15	9.8	33	4.5

# Inductive proximity sensors

## OsiSense XS Application

Sensors for rotation monitoring, slip detection and shaft overload detection, with teach mode

### Flush mountable in metal

PBT case

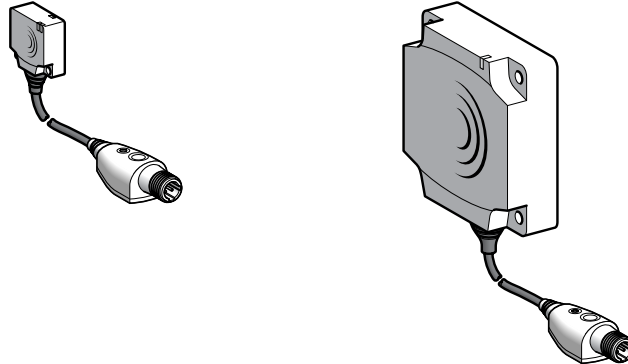

Nominal sensing distance (Sn)	10 mm	15 mm	10 mm	15 mm
Adjustable frequency range	6...6000 impulses/min			

### References

3-wire	PNP / NC	XS9E11RPBL01M12	XS9C11RPBL01M12	–	–
2-wire	⋮ or ~ / NC	–	–	XS9E11RMBL01U20	XS9C11RMBL01U20
Weight (kg)		0.040	0.060	0.040	0.060

### Characteristics

Product certifications	UL, CSA, CE			
Connection	Remote M12 connector on 0.15 m flying lead		Remote 1/2"-20UNF connector on 0.15 m flying lead	
Operating zone	0...8 mm	0...12 mm	0...8 mm	0...12 mm
Degree of protection	Conforming to IEC 60529 IP 67, double insulation □			
Storage temperature	- 40...+ 85 °C			
Operating temperature	- 25...+ 70 °C			
Vibration resistance	Conforming to IEC 60068-2-6 25 gn, amplitude ± 2 mm (f = 10 to 55 Hz)			
Shock resistance	Conforming to IEC 60068-2-27 50 gn, duration 11 ms			
Indicators	Output state Supply on			
Rated supply voltage	⋮ 12...24 V		~ or ⋮ 24...240 V (50/60 Hz)	
Voltage limits (including ripple)	⋮ 10...36 V		~ or ⋮ 20...264 V	
Switching capacity	≤ 100 mA (1)	≤ 200 mA (1)	~ or ⋮ 5...100 mA (2)	⋮ 5...200 mA, ~ 5...300 mA(2)
Voltage drop, closed state	≤ 2 V		≤ 5.5 V	
Residual current, open state	≤ 100 mA		≤ 1.5 mA	
Current consumption, no-load	≤ 10 mA		–	
Maximum switching frequency	48,000 impulses/min			
"Run-up" delay following power-up	9 seconds + 1/Fr			

(1) With overload and short-circuit protection.

(2) It is essential to connect a 0.4 A "quick-blow" fuse in series with the load.

### Wiring schemes

Connector		3-wire ⋮	2-wire ~ or ⋮
M12	1/2"-20UNF	XS9●11RPBL01M12	XS9●11RMBL01U20

### Accessory (1)

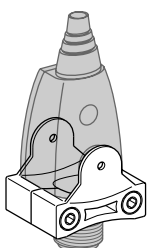

XSZBPM12

Description	Reference	Weight kg
Remote control fixing clamp	XSZBPM12	0.015

(1) For accessories, see page 128.

# Inductive proximity sensors

## OsiSense XS Application

Sensors with analogue output signal 0...10 V <sup>(1)</sup> or 4...20 mA

For position, displacement and deformation control/monitoring

### Functions

Example:  
Sorting parts

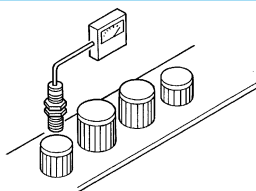

These analogue output proximity sensors are solid-state sensors designed for monitoring displacement. They are not measuring sensors. They are suitable for use in many sectors, particularly for applications involving:

- deformation and displacement monitoring,
- vibration amplitude and frequency monitoring,
- control of dimensional tolerances,
- position control,
- concentricity or eccentricity monitoring.

### Operating principle

The operating principle of the sensor is that of a damped oscillator. The degree of damping will depend on the distance of an object from the sensing face. The sensor will sense the distance and produce an output current with a value directly proportional to this distance.

### Output curves 4..0.20 mA, 2-wire connection

**XS1M12AB120**  
Sn = 0.2...2 mm

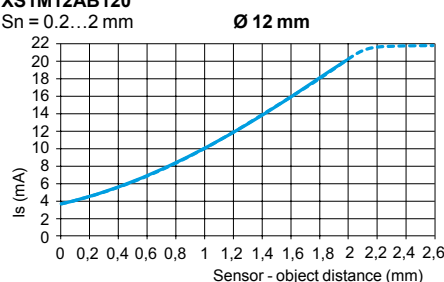

**XS1M18AB120**  
Sn = 0.5...5 mm

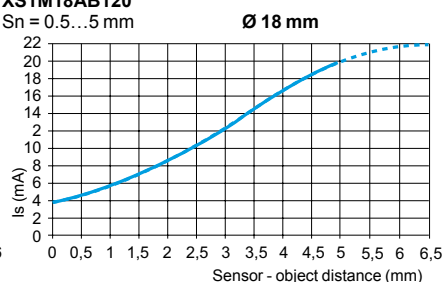

**XS1M30AB120**  
Sn = 1...10 mm

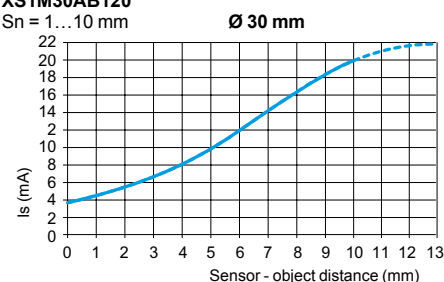

**XS4P12AB120**  
Sn = 0.4...4 mm

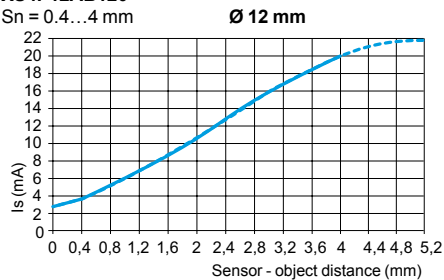

**XS4P18AB120**  
Sn = 0.8...8 mm

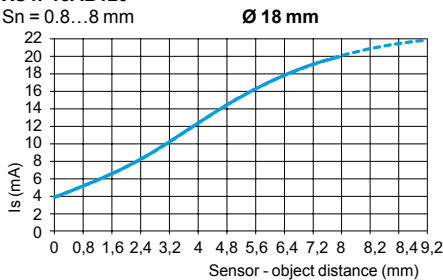

**XS4P30AB120**  
Sn = 1.5...15 mm

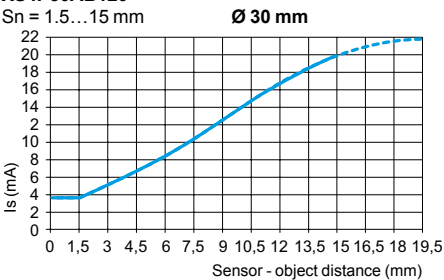

### Output curves 0...10 V, 3-wire connection

**XS4P12AB110**  
Sn = 0.4...4 mm

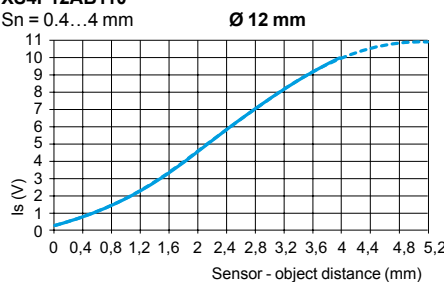

**XS4P18AB110**  
Sn = 0.8...8 mm

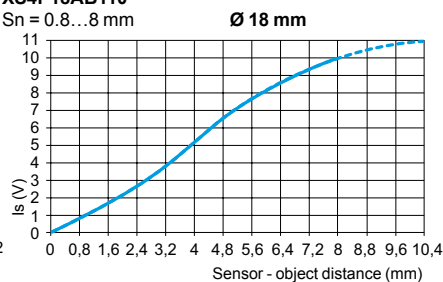

**XS4P30AB110**  
Sn = 1.5...15 mm

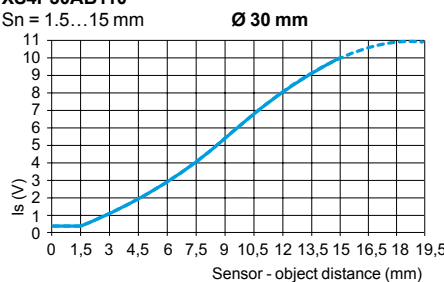

### Wiring schemes

#### 2-wire connection

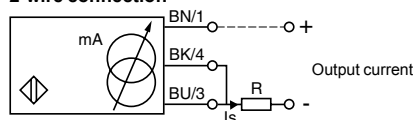

#### 3-wire connection

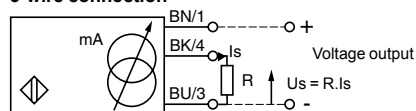

Output current	Load impedance value
12 V	4...20 mA
24 V	4...20 mA
	$R \leq 8.2 \Omega$
	$R \leq 470 \Omega$

Ensure a minimum of 10 V between the + and the - (terminal 3) of the sensor.

Output current	Load impedance value	Output voltage	Load impedance value
24 V	0...10 mA	0...10 V	$R = 1000 \Omega$
48 V	0...10 mA	0...10 V	$R = 1000 \Omega$

Ensure a minimum of 5 V between the + and the sensor output (terminal 4).

(1) Voltage range only obtained with a load impedance of 1000  $\Omega$ .

# Inductive proximity sensors

OsiSense XS Application

Sensors with analogue output signal 0...10 V <sup>(1)</sup> or 4...20 mA

For position, displacement and deformation control/monitoring

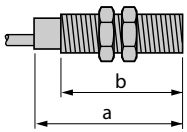
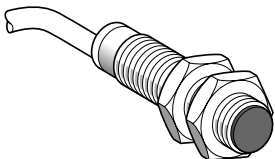
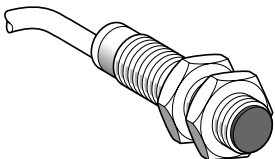
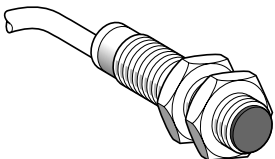
Sensor	Flush mountable in metal	Non flush mountable in metal	
			
Lengths (mm): a = Overall b = Threaded section	a = 50 b = 42	a = 50 b = 42	a = 50 b = 42
Nominal sensing distance (Sn)	<b>Metal case</b> 2 mm	<b>Plastic case</b> 4 mm	<b>Plastic case</b> 4 mm

References			
3-wire --- Output 0...10 V (2)	–	–	<b>XS4P12AB110</b>
2-wire --- Output 4...20 mA (2)	<b>XS1M12AB120</b>	<b>XS4P12AB120</b>	–
Weight (kg)	0.075	0.065	0.065

Characteristics			
Product certifications	CE, UL, CSA		
Connection	Pre-cabled, PvR 3 x 0.34 mm <sup>2</sup> , length 2 m		
Degree of protection Conforming to IEC 60529	IP 67		
Operating zone	0.2...2 mm	0.4...4 mm	0.4...4 mm
Repeat accuracy	± 3 %		
Linearity error	± 2 mA		± 1 V
Ambient air temperature	For operation: - 25...+ 70 °C		
Rated supply voltage	--- 12...24 V	--- 12...24 V	--- 24...48 V
Voltage limits (including ripple)	--- 10...36 V	--- 10...36 V	--- 15...58 V
Output current drift Ambient temperature: - 25...+ 70 °C	≤ 10 %		
Current consumption, no-load	4 mA		
Maximum operating rate	1500 Hz		

(1) Voltage range only obtained with a load impedance of 1000 Ω.

(2) Output current range Is, see page 86.

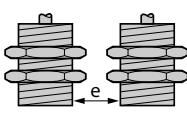
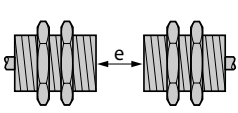
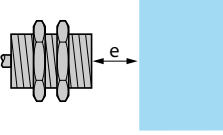
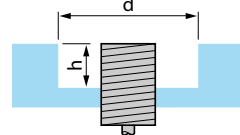
Setting-up				
Minimum mounting distances (mm)	Side by side	Face to face	Facing a metal object	Mounted in a metal support
				
<b>XS1M12AB120 flush mountable</b>	e ≥ 4	e ≥ 24	e ≥ 6	d ≥ 12, h ≥ 0
<b>XS4P12AB110 non flush mountable</b>	e ≥ 16	e ≥ 48	e ≥ 12	d ≥ 36, h ≥ 8
<b>XS4P12AB120 non flush mountable</b>	e ≥ 16	e ≥ 48	e ≥ 12	d ≥ 36, h ≥ 8
Fixing nut tightening torque	< 6 N.m (metal case), < 2 N.m (plastic case)			
Other versions	Please consult our Customer Care Centre.			



# Inductive proximity sensors

OsiSense Application

Sensors with analogue output signal 0...10 V <sup>(1)</sup> or 4...20 mA

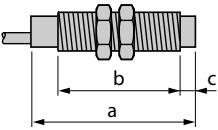
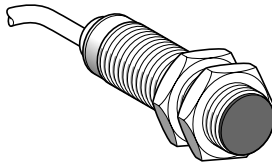
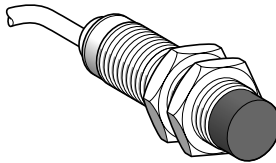
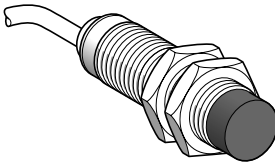
Sensor	Flush mountable in metal	Non flush mountable in metal	
			
Lengths (mm): a = Overall b = Threaded section c = For non flush mountable sensors	a = 53 b = 44 c = 0	a = 41 b = 26 c = 8	a = 41 b = 26 c = 8
Nominal sensing distance (S <sub>n</sub> )	<b>Metal case</b> 5 mm	<b>Plastic case</b> 8 mm	<b>Plastic case</b> 8 mm

References			
3-wire $\overline{\text{---}}$ Output 0...10 V <sup>(2)</sup>	–	–	<b>XS4P18AB110</b>
2-wire $\overline{\text{---}}$ Output 4...20 mA <sup>(2)</sup>	<b>XS1M18AB120</b>	<b>XS4P18AB120</b>	–
Weight (kg)	0.120	0.080	0.080

Characteristics			
Product certifications	CE, UL, CSA		
Connection	Pre-cabled, PvR 3 x 0.34 mm <sup>2</sup> , length 2 m		
Degree of protection Conforming to IEC 60529	IP 67		
Operating zone	0.5...5 mm	0.8...8 mm	0.8...8 mm
Repeat accuracy	± 3 %		
Linearity error	± 2 mA		± 1 V
Ambient air temperature	For operation: - 25...+ 70 °C		
Rated supply voltage	$\overline{\text{---}}$ 12...24 V	$\overline{\text{---}}$ 12...24 V	$\overline{\text{---}}$ 24...48 V
Voltage limits (including ripple)	$\overline{\text{---}}$ 10...36 V	$\overline{\text{---}}$ 10...36 V	$\overline{\text{---}}$ 15...58 V
Output current drift Ambient temperature: - 25...+ 70 °C	≤ 10 %		
Current consumption, no-load	4 mA		
Maximum operating rate	500 Hz		

<sup>(1)</sup> Voltage range only obtained with a load impedance of 1000 Ω.

<sup>(2)</sup> Output current range is, see page 86.

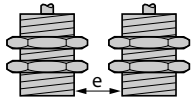
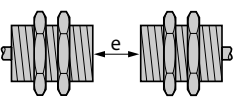
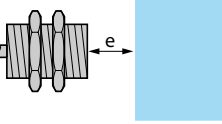
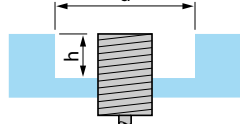
Setting-up				
Minimum mounting distances (mm)	Side by side	Face to face	Facing a metal object	Mounted in a metal support
				
<b>XS1M18AB120 flush mountable</b>	e ≥ 10	e ≥ 60	e ≥ 15	d ≥ 18, h ≥ 0
<b>XS4P18AB110 non flush mountable</b>	e ≥ 32	e ≥ 96	e ≥ 24	d ≥ 54, h ≥ 16
<b>XS4P18AB120 non flush mountable</b>	e ≥ 32	e ≥ 96	e ≥ 24	d ≥ 54, h ≥ 16

**Fixing nut tightening torque** < 15 N.m (metal case), < 5 N.m (plastic case)

**Other versions** Please consult our Customer Care Centre.

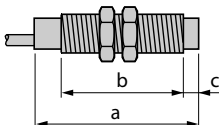
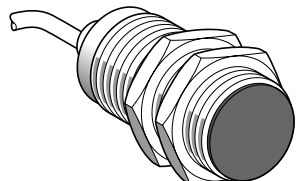
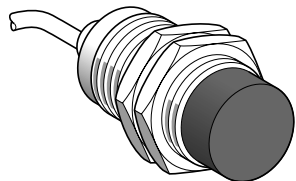
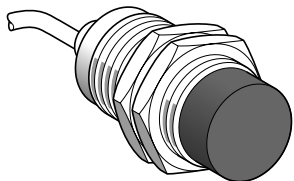
Sensor	Flush mountable in metal	Non flush mountable in metal	
			
Lengths (mm): a = Overall b = Threaded section c = For non flush mountable sensors	a = 50 b = 42 c = 0	a = 53 b = 32 c = 13	a = 53 b = 32 c = 13
Nominal sensing distance (Sn)	<b>Metal case</b> 10 mm	<b>Plastic case</b> 15 mm	<b>Plastic case</b> 15 mm

References			
3-wire ---	Output 0...10 V (2)	–	XS4P30AB110
2-wire ---	Output 4...20 mA (2)	XS1M30AB120	XS4P30AB120
Weight (kg)		0.200	0.100

Characteristics			
Product certifications	CE, UL, CSA		
Connection	Pre-cabled, PvR 3 x 0.34 mm <sup>2</sup> , length 2 m		
Degree of protection Conforming to IEC 60529	IP 67		
Operating zone	1...10 mm	1.5...15 mm	1.5...15 mm
Repeat accuracy	± 3 %		
Linearity error	± 2 mA		± 1 V
Ambient air temperature	For operation: - 25...+ 70 °C		
Rated supply voltage	--- 12...24 V	--- 12...24 V	--- 24...48 V
Voltage limits (including ripple)	--- 10...36 V	--- 10...36 V	--- 15...58 V
Output current drift Ambient temperature: - 25...+ 70 °C	≤ 10 %		
Current consumption, no-load	4 mA		
Maximum operating rate	300 Hz		

(1) Voltage range only obtained with a load impedance of 1000 Ω.

(2) Output current range Is, see page 86.

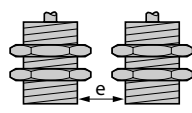
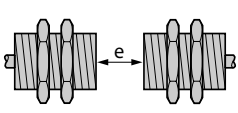
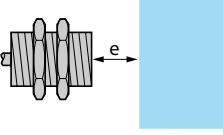
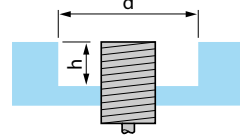
Setting-up				
Minimum mounting distances (mm)	Side by side	Face to face	Facing a metal object	Mounted in a metal support
				
XS1M30AB120 flush mountable	e ≥ 20	e ≥ 120	e ≥ 30	d ≥ 30, h ≥ 0
XS4P30AB110 non flush mountable	e ≥ 60	e ≥ 180	e ≥ 45	d ≥ 90, h ≥ 30
XS4P30AB120 non flush mountable	e ≥ 60	e ≥ 180	e ≥ 45	d ≥ 90, h ≥ 30
Fixing nut tightening torque	< 40 N.m (metal case), < 20 N.m (plastic case)			
Other versions	Please consult our Customer Care Centre.			

# Inductive proximity sensors

## OsiSense XS Application

Sensors with analogue output signal 0...10 V <sup>(1)</sup>

For position, displacement and deformation control/monitoring

### Functions

These analogue output proximity sensors are solid-state sensors designed for monitoring displacement. They are not measuring sensors.

**They are suitable for use in many sectors, particularly for applications involving:**

- deformation and displacement monitoring,
- vibration amplitude and frequency monitoring,
- control of dimensional tolerances,
- position control,
- concentricity or eccentricity monitoring.

### Operating principle

The operating principle of the sensor is that of a damped oscillator. The degree of damping will depend on the distance of an object from the sensing face. The sensor will sense the distance and produce an output current with a value directly proportional to this distance.

### Output curves 0...10 V, 3-wire connection

#### XS9F

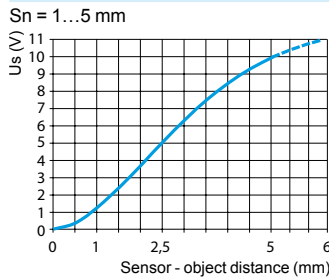

#### XS9E

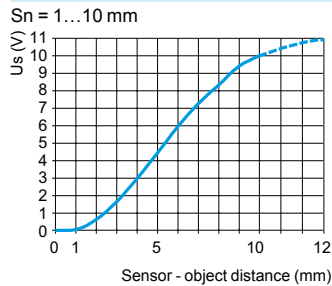

#### XS9C

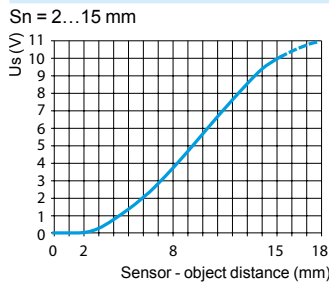

#### XS9D

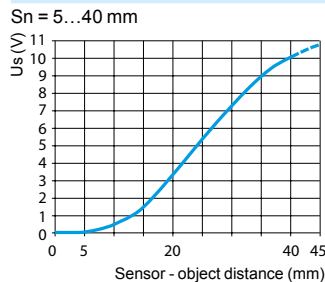

### Wiring schemes

#### Connector



#### Pre-cabled

BN: Brown  
BU: Blue  
BK: Black

#### 3-wire connection

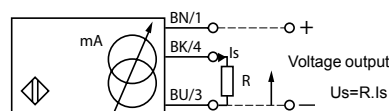

Output current	Load impedance value	Output voltage	Load impedance value
24 V	0...10 mA	$R \leq 1400 \Omega$	0...10 V
			$R = 1000 \Omega$

**Note:** Ensure a minimum of 5 V between the + (terminal 1) and the sensor output (terminal 4).

<sup>(1)</sup> Voltage range only obtained with a load impedance of 1000  $\Omega$ .

# Inductive proximity sensors

## OsiSense XS Application

Sensors with analogue output signal 0...10 V <sup>(1)</sup>

For position, displacement and deformation control/monitoring

### Flush mountable in metal

#### PBT case

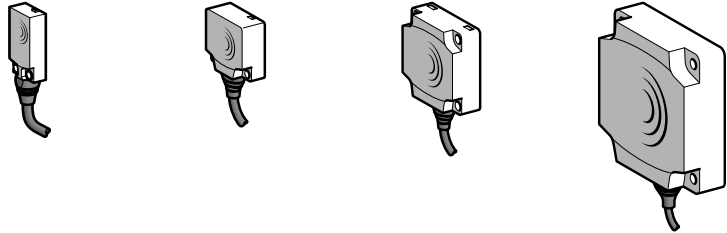

Nominal sensing distance (Sn)		5 mm	10 mm	15 mm	40 mm
<b>References</b>					
3-wire $\overline{\text{---}}$	Pre-cabled (L = 2 m) (2)	<b>XS9F111A1L2</b>	<b>XS9E111A1L2</b>	<b>XS9C111A1L2</b>	<b>XS9D111A1L2</b>
0...10 V	Connector	<b>XS9F111A1L01M8</b>	<b>XS9E111A1L01M12</b>	<b>XS9C111A1L01M12</b>	<b>XS9D111A1M12</b>
<b>Weight (kg)</b>	Pre-cabled (L = 2 m) (2)	0.060	0.075	0.095	0.340
	Connector	0.040	0.055	0.075	0.320

### Characteristics

<b>Product certifications</b>		UL, CSA, CE			
<b>Connection</b>	Pre-cabled	PvR 3 x 0.34 mm <sup>2</sup> , length 2 m for <b>XS9●111A●L2</b>			
	Connector	0.15 m flying lead with M8 connector	0.15 m flying lead with M12 connector		M12
<b>Operating zone</b>		<b>1...5 mm</b>	<b>1...10 mm</b>	<b>2...15 mm</b>	<b>5...40 mm</b>
<b>Degree of protection</b> Conforming to IEC 60529	Pre-cabled	IP 68	IP 68, double insulation $\square$		
	Connector	IP 67	IP 67, double insulation $\square$		
<b>Storage temperature</b>		- 40...+ 85 °C			
<b>Operating temperature</b>		- 25...+ 70 °C			
<b>Materials</b>		PBT case			
<b>Vibration resistance</b>	Conforming to IEC 60068-2-6	25 gn, amplitude $\pm$ 2 mm (f = 10 to 55 Hz)			
<b>Shock resistance</b>	Conforming to IEC 60068-2-27	50 gn, duration 11 ms			
<b>Output state indication</b>		No			
<b>Rated supply voltage</b>		$\overline{\text{---}}$ 24 V			
<b>Voltage limits (including ripple)</b>		$\overline{\text{---}}$ 15...36 V			
<b>Repeat accuracy</b>		$\pm$ 3 %			
<b>Linearity error</b>		$\pm$ 1 V			
<b>Current consumption, no-load</b>		$\leq$ 4 mA with overload and short-circuit protection			
<b>Maximum operating frequency</b>		2000 Hz	1000 Hz	100 Hz	
<b>Output current drift</b>		$\leq$ 10 % (throughout the operating temperature range)			

### Dimensions

XS9F	XS9E/C/D		XS9C/D	XS9E			
	(2) For CHC type screws						
<b>Type</b>	<b>A (L2)</b>	<b>A (M12)</b>	<b>B</b>	<b>C</b>	<b>D</b>	<b>E</b>	<b>F</b>
<b>XS9E</b>	14	—	26	13	8.8	20	3.5
<b>XS9C</b>	14	—	40	15	9.8	33	4.5
<b>XS9D</b>	23	14	80	26	16	65	5.5

### Setting-up (Minimum mounting distances (mm))

Type	Side by side	Face to face	Facing a metal object
<b>XS9F</b>			
<b>XS9E</b>	$e \geq 15$	$e \geq 36$	$e \geq 15$
<b>XS9C</b>	$e \geq 30$	$e \geq 72$	$e \geq 30$
<b>XS9D</b>	$e \geq 45$	$e \geq 110$	$e \geq 45$
<b>XS9D</b>	$e \geq 120$	$e \geq 300$	$e \geq 120$

(1) Voltage range only obtained with a load impedance of 1000  $\Omega$ .

(2) For a 5 m long cable replace L2 by L5, for a 10 m long cable replace L2 by L10.  
Example: XS9C111A1L2 becomes XS9C111A1L5 with a 5 m long cable.

# Inductive proximity sensors

## OsiSense XS Application

Sensors with analogue output signal 4...20 mA

For position, displacement and deformation control/monitoring

### Functions

These analogue output proximity sensors are solid-state sensors designed for monitoring displacement. They are not measuring sensors.

**They are suitable for use in many sectors, particularly for applications involving:**

- deformation and displacement monitoring,
- vibration amplitude and frequency monitoring,
- control of dimensional tolerances,
- position control,
- concentricity or eccentricity monitoring.

### Operating principle

The operating principle of the sensor is that of a damped oscillator. The degree of damping will depend on the distance of an object from the sensing face. The sensor will sense the distance and produce an output current with a value directly proportional to this distance.

### Output curves 4...20 mA, 2-wire connection

#### XS9F

Sn = 1...5 mm

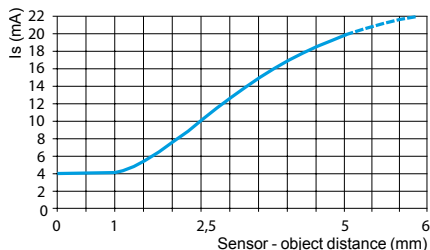

#### XS9E

Sn = 1...10 mm

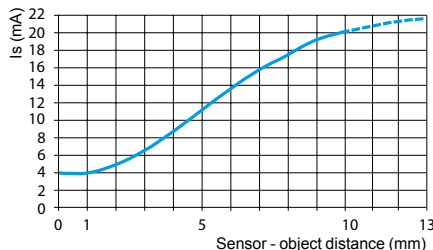

#### XS9C

Sn = 2...15 mm

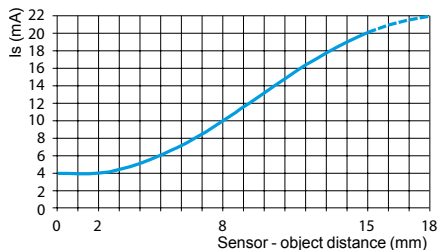

#### XS9D

Sn = 5...40 mm

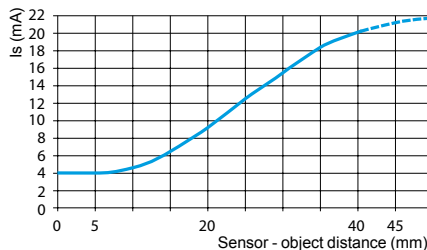

### Wiring schemes

#### Connector

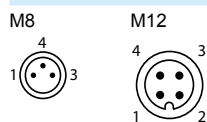

#### Pre-cabled

BN: Brown  
BU: Blue  
BK: Black

#### 2-wire connection

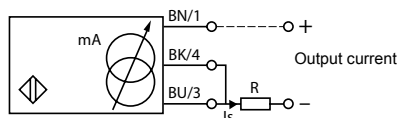

Output current	Load impedance value
12 V 4...20 mA	$R \leq 8.2 \Omega$
24 V 4...20 mA	$R \leq 470 \Omega$

**Note:** Ensure a minimum of 10 V between the + (terminal 1) and - (terminal 3) of the sensor.

# Inductive proximity sensors

## OsiSense XS Application

Sensors with analogue output signal 4...20 mA

For position, displacement and deformation control/monitoring

### Flush mountable in metal

PBT case

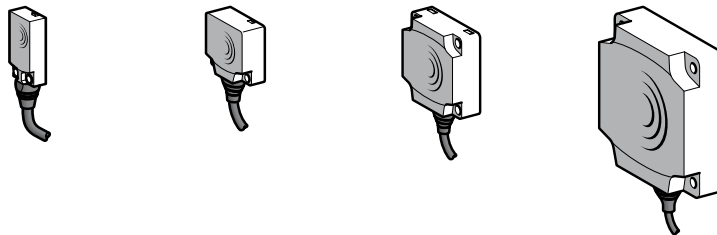

Nominal sensing distance (Sn)	5 mm	10 mm	15 mm	40 mm
-------------------------------	------	-------	-------	-------

### References

2-wire $\overline{\text{---}}$	Pre-cabled (L = 2 m) (1)	<b>XS9F111A2L2</b>	<b>XS9E111A2L2</b>	<b>XS9C111A2L2</b>	<b>XS9D111A2L2</b>
4...20 mA	Connector	<b>XS9F111A2L01M8</b>	<b>XS9E111A2L01M12</b>	<b>XS9C111A2L01M12</b>	<b>XS9D111A2M12</b>
Weight (kg)	Pre-cabled (L = 2 m)	0.060	0.075	0.095	0.340
	Connector	0.040	0.055	0.075	0.320

### Characteristics

Product certifications	UL, CSA, CE				
Connection	Pre-cabled	PvR 3 x 0.34 mm <sup>2</sup> , length 2 m for <b>XS9●111A●L2</b>			
	Connector	0.15 m flying lead with M8 connector	0.15 m flying lead with M12 connector		M12
Operating zone	1...5 mm		1...10 mm	2...15 mm	5...40 mm
Degree of protection	Pre-cabled	IP 68		IP 68, double insulation $\square$	
	Connector	IP 67		IP 67, double insulation $\square$	
Storage temperature	- 40...+ 85 °C				
Operating temperature	- 25...+ 60 °C		- 25...+ 70 °C		
Materials	PBT case				
Vibration resistance	Conforming to IEC 60068-2-6	25 gn, amplitude $\pm$ 2 mm (f = 10 to 55 Hz)			
Shock resistance	Conforming to IEC 60068-2-27	50 gn, duration 11 ms			
Output state indication	No				
Rated supply voltage	$\overline{\text{---}}$ 12...24 V				
Voltage limits (including ripple)	$\overline{\text{---}}$ 10...36 V				
Repeat accuracy	$\pm$ 3 %				
Linearity error	$\pm$ 2 mA				
Current consumption, no-load	$\leq$ 4 mA with overload and short-circuit protection				
Maximum operating frequency	2000 Hz	1000 Hz		100 Hz	
Output current drift	$\leq$ 10 % (throughout the operating temperature range)				

### Dimensions

#### XS9F

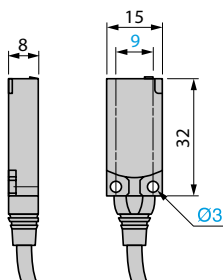

#### XS9E/C/D

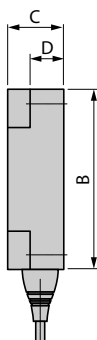

#### XS9C/D

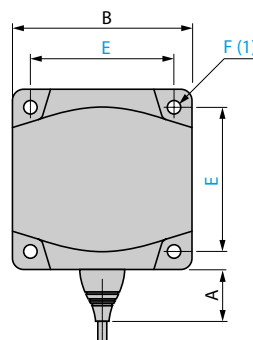

#### XS9E

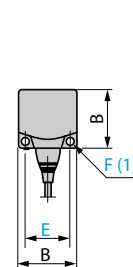

(1) For CHC type screws

Type	A (L2)	A (M12)	B	C	D	E	F
XS9E	14	–	26	13	8.8	20	3.5
XS9C	14	–	40	15	9.8	33	4.5
XS9D	23	14	80	26	16	65	5.5

### Setting-up (Minimum mounting distances (mm))

Type	Side by side	Face to face	Facing a metal object
XS9F			
XS9E	$e \geq 15$	$e \geq 36$	$e \geq 15$
XS9C	$e \geq 30$	$e \geq 72$	$e \geq 30$
XS9D	$e \geq 45$	$e \geq 110$	$e \geq 45$
	$e \geq 120$	$e \geq 300$	$e \geq 120$

(1) For a 5 m long cable replace L2 by L5; for a 10 m long cable replace L2 by L10.

Example: XS9F111A2L2 becomes **XS9F111A2L5** with a 5 m long cable.

# Inductive proximity sensors

## OsiSense XS Application

Sensors with analogue output signal 0...10 V <sup>(1)</sup> or 4...20 mA. Plastic case, 40 x 40 mm front face  
5 position turret head

<b>Sensor</b>	<b>Non flush mountable in metal</b>	
<b>Dimensions</b>	<b>40 x 40 x 70 mm</b>	<b>40 x 40 x 117 mm</b>

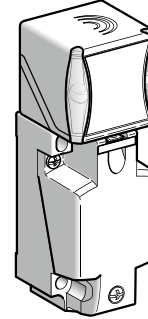
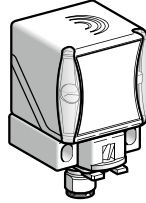

<b>Nominal sensing distance (Sn)</b>	25 mm
--------------------------------------	-------

### References

<b>3-wire</b> $\text{---}$	0...10 V output <sup>(1)</sup>	<b>XS9C2A2A1M12</b>	<b>XS9C4A2A1P20</b> <sup>(2)</sup>
<b>2-wire</b> $\text{---}$	4...20 mA output	<b>XS9C2A2A2M12</b>	<b>XS9C4A2A2P20</b> <sup>(2)</sup>

**XS9C4●●●P20** sensors are available with an ISO M20 cable entry and can be supplied with a PG 13.5 (e.g. **XS9C4A2A1G13**) or a 1/2" NPT (e.g. **XS9C4A2A2N12**) cable entry: please consult our Customer Care Centre for more information.

<b>Weight (kg)</b>	0.149	0.244
--------------------	-------	-------

### Characteristics

<b>Product certifications</b>	UL, CSA, CE	
<b>Conformity to standards</b>	IEC 60947-5-2 and IEC 60947-5-7	
<b>Connection</b>	M12 connector (4-pin)	Screw terminals, clamping capacity 3 x 1.5 mm <sup>2</sup>
<b>Operating zone</b>	2...27 mm	
<b>Linearity error</b>	< 3%	
<b>Repeat accuracy</b>	< 3%	
<b>Output current drift</b>	< 5%	
<b>Degree of protection</b>	Conforming to IEC 60529 and DIN 40050	IP 65, IP 67 and IP 69K
<b>Temperature</b>	Storage	- 40...+ 85°C
	Operation <sup>(3)</sup>	- 25...+ 70°C
<b>Material</b>	Case: PBT	
<b>Vibration resistance</b>	Conforming to IEC 60068-2-6	25 gn, amplitude $\pm$ 2 mm (f = 10...55 Hz)
<b>Shock resistance</b>	Conforming to IEC 60068-2-27	50 gn for 11 ms
<b>Indicators</b>	Output state (alignment aid)	Yellow LED
<b>Rated supply voltage</b>	4...20 mA	$\text{---}$ 12...24 V with protection against reverse polarity
	0...10 V	$\text{---}$ 24 V with protection against reverse polarity
<b>Voltage limits (including ripple)</b>	4...20 mA	$\text{---}$ 12...36 V
	0...10 V	$\text{---}$ 15...36 V
<b>Current consumption, no-load</b>	3-wire $\text{---}$	< 4 mA
<b>Delays</b>	First-up	< 7 ms
	Response	< 6 ms
	Recovery	< 6 ms

### Analogue outputs 4-20 mA and 0-10 V

<b>XS9 C2A2A2M12 and XS9 C4A2A2P20</b>	<b>XS9 C2A2A1M12 and XS9 C4A2A1P20</b>
--	--

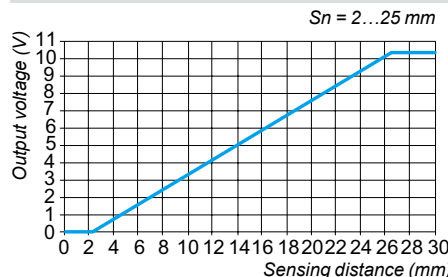
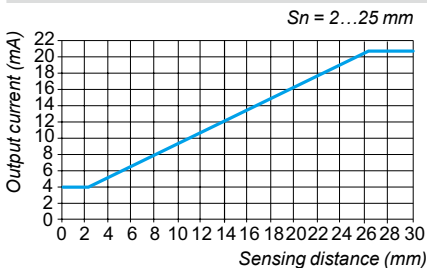

(1) Voltage range only obtained with a load impedance of 1000  $\Omega$ .

(2) These sensors are supplied without a cable gland. An adaptable PG 13.5 cable gland is available (reference **XSZ PE13**).

(3) Sensors are available for very low temperatures (suffix **TF**: - 40°C, + 70°C) or very high temperatures (suffix **TT**: - 25°C, + 85°C); please consult our Customer Care Centre.



# Inductive proximity sensors

## OsiSense XS Application

Sensors with analogue output signal 0...10 V <sup>(1)</sup> or 4...20 mA. Plastic case, 40 x 40 mm front face  
5 position turret head

### Setting-up precautions

#### Minimum mounting distances (mm)

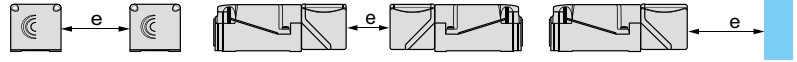

Side by side

Face to face

Facing a metal object

Sensors non flush mountable in metal

$e \geq 120$

$e \geq 240$

$e \geq 90$

### Wiring schemes

#### 2-wire

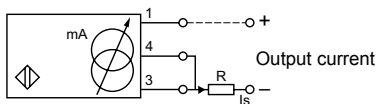

#### 3-wire

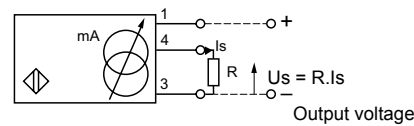

	Output current	Load impedance value
12 V	4...20 mA	$R \leq 82 \Omega$
24 V	4...20 mA	$R \leq 560 \Omega$

Ensure a minimum of 10 V between the + and the - (terminal 3) of the sensor.

	Output current	Load impedance value	Output voltage	Load impedance value
12 V	0...10 mA	$R \leq 630 \Omega$	-	-
24 V	0...10 mA	$R \leq 1500 \Omega$	0...10 V	$R = 1000 \Omega$

Ensure a minimum of 5 V between the + and the sensor output (terminal 4).

### Dimensions

#### XS9C2A2A1M12 and XS9C2A2A2M12

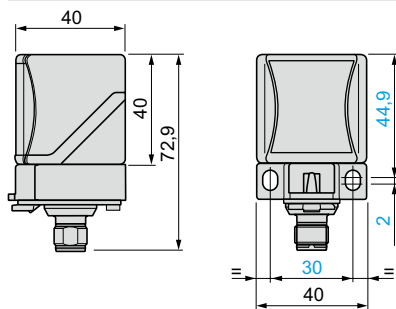

### Head positions

#### XS9C2A2A1M12 and XS9C2A2A2M12

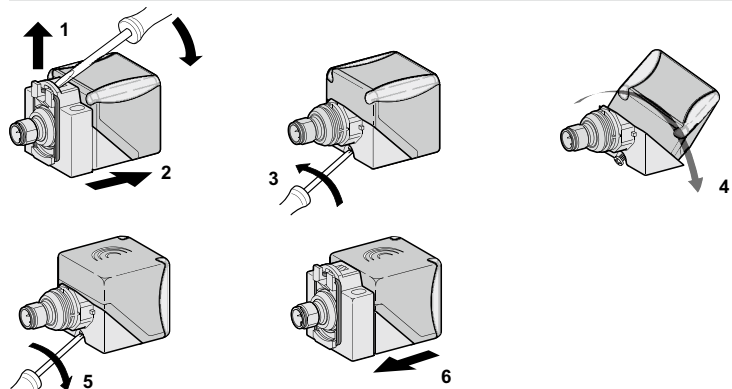

#### XS9C4A2A1P20 and XS9C4A2A2P20

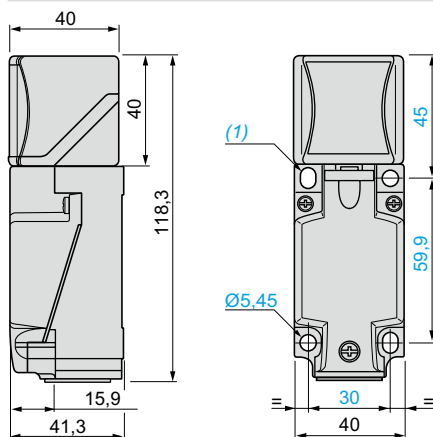

#### XS9C4A2A1P20 and XS9C4A2A2P20

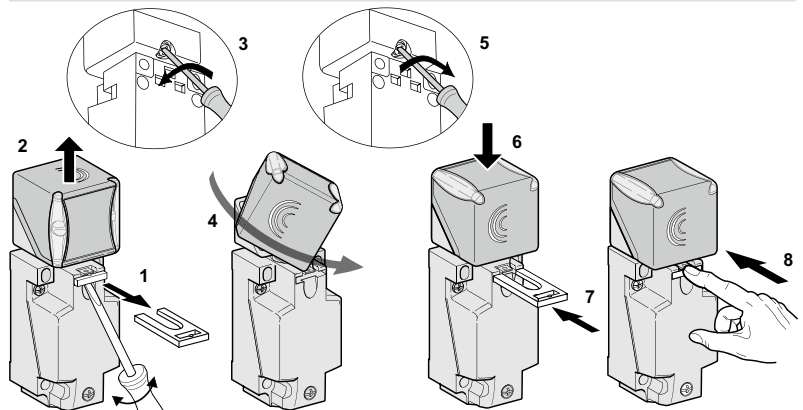

(1) 2 elongated holes  $\varnothing 5.3 \times 7$  mm.

Tightening torque of cover fixing screws and clamp screws:  $< 1.2$  N.m

(1) Voltage range only obtained with a load impedance of 1000  $\Omega$ .

# Inductive proximity sensors

## OsiSense XS Application

Cylindrical, stainless steel 316L front face for food and beverage applications and harsh industrial environments. Three-wire DC, solid-state output

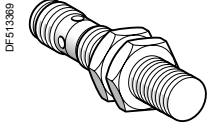

XS912●1PAM12

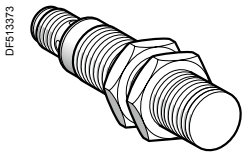

XS918●1PAM12

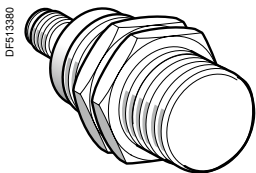

XS930●1PAM12

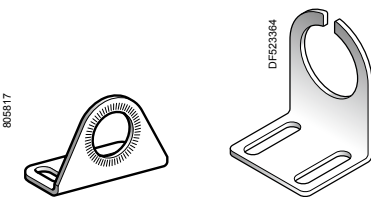

XUZA118

XSZBS30

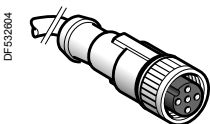

XZCP1141L●

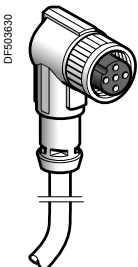

XZCP1241L●

### Ø 12 mm, threaded M12 x 1

Sensing distance (Sn) mm	Function	Output	Connection	Reference	Weight kg
<b>Three-wire 12-24V DC, flush mountable</b>					
6	NO	PNP	M12	XS912S1PAM12	0.024

### Three-wire 12-24V DC, non flush mountable

10	NO	PNP	M12	XS912S4PAM12	0.023
----	----	-----	-----	--------------	-------

### Ø 18 mm, threaded M18 x 1

Sensing distance (Sn) mm	Function	Output	Connection	Reference	Weight kg
<b>Three-wire 12-24V DC, flush mountable</b>					
10	NO	PNP	M12	XS918S1PAM12	0.051

### Three-wire 12-24V DC, non flush mountable

20	NO	PNP	M12	XS918S4PAM12	0.051
----	----	-----	-----	--------------	-------

### Ø 30 mm, threaded M30 x 1.5

Sensing distance (Sn) mm	Function	Output	Connection	Reference	Weight kg
<b>Three-wire 12-24V DC, flush mountable</b>					
20	NO	PNP	M12	XS930S1PAM12	0.140

### Three-wire 12-24V DC, non flush mountable

40	NO	PNP	M12	XS930S4PAM12	0.145
----	----	-----	-----	--------------	-------

### Accessories

Description	For use with sensor	Reference	Weight kg
Stainless steel mounting bracket	Ø 12	XSZBS12	0.090
	Ø 18	XUZA118	0.190
	Ø 30	XSZBS30	0.370

### Connecting cables (PVC) (1)

Description	Type	Length m	Reference	Weight kg
Pre-wired M12 connectors Female, 4-pin Stainless steel clamping ring	Straight	2	XZCPA1141L2	0.090
		5	XZCPA1141L5	0.190
		10	XZCPA1141L10	0.370
	Elbowed	2	XZCPA1241L2	0.090
		5	XZCPA1241L5	0.190
		10	XZCPA1241L10	0.370

### Wiring schemes

#### M12 connector



#### PNP

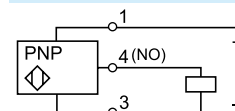

(1) For further information, please consult the catalogue "Cabling accessories OsiSense XZ" on our site [www.tesensors.com](http://www.tesensors.com).

Characteristics					
Sensor type	Flush		XS912S1PAM12	XS918S1PAM12	XS930S1PAM12
	Non flush		XS912S4PAM12	XS918S4PAM12	XS930S4PAM12
Product certifications			CE, cULus		
Connection	Connector		M12		
Operating zone	Flush	mm	0...4.8	0...8	0...16
	Non flush	mm	0...8	0...16	0...32
Differential travel		%	1...15 (real sensing distance Sr)		
Degree of protection	Conforming to IEC 60529		IP 68 (5 meters underwater for 1 month)		
	Conforming to DIN 40050		IP 69K		
Storage temperature		°C	-25...+85 (-13...185°F)		
Operating temperature		°C	-25...+85 (-13...185°F)		
Materials	Case		Stainless steel, 316L grade		
Front face thickness		mm	0.4	0.6	1.0
Mechanical shock resistance	Conforming to EN 50102		IK10		
Vibration resistance	Conforming to IEC 60068-2-6		25 gn, amplitude ± 1 mm (f = 10 to 55 Hz)		
Shock resistance	Conforming to IEC 60068-2-27		30 gn, duration 11 ms		
Output state indication			Yellow LED, 4 viewing points at 90° (blinking from 0.8 Sr and Sr)		
Rated supply voltage		V	12...24 with protection against reverse polarity		
Voltage limits (including ripple)		V	10...30		
Switching capacity		mA	≤ 200 with overload and short-circuit protection		
Voltage drop, closed state		V	≤ 2		
Current consumption, no-load		mA	≤ 10		
Maximum switching frequency	Flush	Hz	600	300	100
	Non flush	Hz	400	200	90
Delays	First set-up	ms	40		
	Response	µs	0.06		
	Recovery	µs	15		

## Setting-up

### Minimum mounting distances in mm, flush version

Side by side		Face to face	Facing a metal object	Mounted in a metal support
Ø 12	e ≥ 38	e ≥ 30	e ≥ 20	d ≥ 24
Ø 18	e ≥ 42	e ≥ 40	e ≥ 30	d ≥ 50
Ø 30	e ≥ 80	e ≥ 70	e ≥ 60	d ≥ 90

### Minimum mounting distances in mm, non flush version

Side by side		Face to face	Facing a metal object	Mounted in a metal support
Ø 12	e ≥ 108	e ≥ 40	e ≥ 30	d ≥ 30 h ≥ 22
Ø 18	e ≥ 182	e ≥ 70	e ≥ 60	d ≥ 60 h ≥ 34
Ø 30	e ≥ 270	e ≥ 130	e ≥ 120	d ≥ 120 h ≥ 34

## Dimensions

	Flush sensor			Non flush sensor		
	M12	M18	M30	M12	M18	M30
a (mm)	60	63.5	63.5	60	63.5	63.5
b (mm)	41	42	42	36	35	32
c (mm)	0	0	0	5	7	10

Lengths (mm):  
a = overall  
b = threaded  
c = for non flush mountable sensors

## Reduction coefficient

Flush-non mounted	Flush sensor			Non flush sensor		
	M12	M18	M30	M12	M18	M30
Steel	1	1	1	1	1	1
Aluminum	1	1	1	1	1	1
Brass	1.3	1.2	1.3	1.4	1.35	1.2
Copper	0.85	0.8	0.9	0.8	0.9	0.9
Stainless steel	Thickness 1 mm	0.5	0.5	(1)	0.3	(1)
	Thickness 2 mm	0.9	0.9	0.7	0.66	0.6
Flush mounted	M12	M18	M30	(1) No detection.		
Steel	0.7	0.75	0.9			
Aluminum	1.15	0.9	0.7			
Brass	1.05	0.75	0.6			
Stainless steel	0.8	0.8	1.3			

# Inductive proximity sensors

OsiSense XS Application, food and beverage processing series  
Cylindrical, stainless steel, non flush mountable  
Three-wire DC, solid-state output

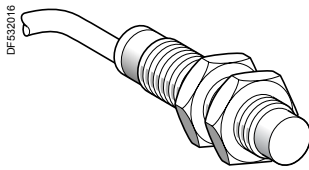

XS212SA●●L2

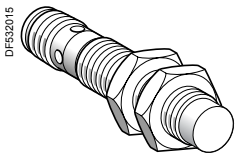

XS212SA●●M12

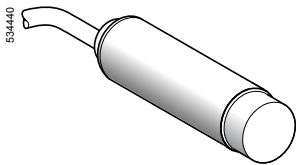

XS2L2SA●●L2

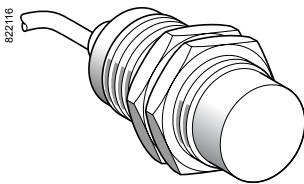

XS230SA●●L2

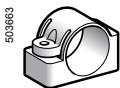

XUZH2005

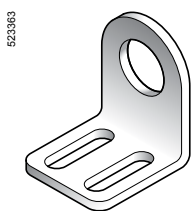

XSZBS12

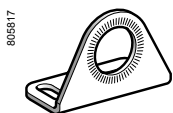

XUZA118

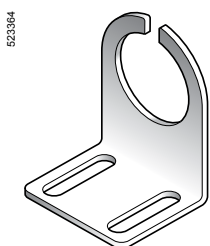

XSZBS30

## Ø 12, threaded M12 x 1

Sensing distance (Sn) mm	Function	Output	Connection	Reference	Weight kg
7	NO	PNP	Pre-cabled (L = 2 m) (1)	<b>XS212SAPAL2</b>	0.075
			M12 connector	<b>XS212SAPAM12</b>	0.035
		NPN	Pre-cabled (L = 2 m) (1)	<b>XS212SANAL2</b>	0.075
			M12 connector	<b>XS212SANAM12</b>	0.035

## Ø 18, threaded M18 x 1

Sensing distance (Sn) mm	Function	Output	Connection	Reference	Weight kg
12	NO	PNP	Pre-cabled (L = 2 m) (1)	<b>XS218SAPAL2</b>	0.120
			M12 connector	<b>XS218SAPAM12</b>	0.060
		NPN	Pre-cabled (L = 2 m) (1)	<b>XS218SANAL2</b>	0.120
			M12 connector	<b>XS218SANAM12</b>	0.060

## Ø 18, plain

Sensing distance (Sn) mm	Function	Output	Connection	Reference	Weight kg
12	NO	PNP	Pre-cabled (L = 2 m) (1)	<b>XS2L2SAPAL2</b>	0.120
			M12 connector	<b>XS2L2SAPAM12</b>	0.060
		NPN	Pre-cabled (L = 2 m) (1)	<b>XS2L2SANAL2</b>	0.120
			M12 connector	<b>XS2L2SANAM12</b>	0.060

## Ø 30, threaded M30 x 1.5

Sensing distance (Sn) mm	Function	Output	Connection	Reference	Weight kg
22	NO	PNP	Pre-cabled (L = 2 m) (1)	<b>XS230SAPAL2</b>	0.205
			M12 connector	<b>XS230SAPAM12</b>	0.145
		NPN	Pre-cabled (L = 2 m) (1)	<b>XS230SANAL2</b>	0.205
			M12 connector	<b>XS230SANAM12</b>	0.145

## Accessories (2)

Description	For use with	Reference	Weight kg
<b>Plastic fixing clamp</b> , 24.1 mm centres, with locking screw	Ø 18 sensor, plain case	<b>XUZH2005</b>	0.007
<b>Stainless steel fixing bracket</b>	Ø 12 sensor	<b>XSZBS12</b>	0.060
	Ø 18 sensor	<b>XUZA118</b>	0.045
	Ø 30 sensor	<b>XSZBS30</b>	0.080

## Connecting cables

Description	Type	Length m	Reference	Weight kg
<b>Pre-wired M12 connectors</b> Female, 4-pin, stainless steel clamping ring	Straight	2	<b>XZCPA1141L2</b>	0.090
		5	<b>XZCPA1141L5</b>	0.210
		10	<b>XZCPA1141L10</b>	0.410
	Elbowed	2	<b>XZCPA1241L2</b>	0.090
		5	<b>XZCPA1241L5</b>	0.210
		10	<b>XZCPA1241L10</b>	0.410
<b>M12 jumper cable</b> Male, 3-pin, stainless steel clamping ring	Straight	2	<b>XZCRA151140A2</b>	0.095
		5	<b>XZCRA151140A5</b>	0.200

(1) For a 5 m long cable replace L2 by L5; for a 10 m long cable replace L2 by L10.

Example: **XS212SAPAL2** becomes **XS212SAPAL5** with a 5 m long cable.

(2) For further information, see page 128.

# Inductive proximity sensors

OsiSense XS Application, food and beverage processing series

Cylindrical, stainless steel, non flush mountable

Three-wire DC, solid-state output

Characteristics		XS2●●SA●●M12	XS2●●SA●●L2
Sensor type		UL, CSA, CE	
Product certifications/approvals		UL, CSA, CE	
Connection	Connector	M12	–
	Pre-cabled	–	Length: 2 m
Operating zone	Ø 12	mm	0...5.6
	Ø 18	mm	0...9.6
	Ø 30	mm	0...17.6
Differential travel		%	
Degree of protection		1...15 of effective sensing distance (Sr)	
Degree of protection	Conforming to IEC 60529	IP 67	IP 68, double insulation □
	DIN 40050	IP 69K	
Storage temperature		°C	
Operating temperature		°C	
Materials	Case	Stainless steel 316 L	
	Cable	–	Non-poisonous PVC, 3 x 0.34 mm <sup>2</sup>
Vibration resistance		25 gn, amplitude ± 2 mm (f = 10 to 55 Hz)	
Shock resistance		50 gn, duration 11 ms	
Output state indication		Yellow LED: 4 viewing ports at 90°	Yellow LED: annular
Rated supply voltage		V	
Voltage limits (including ripple)		V	
Switching capacity		mA	
Voltage drop, closed state		V	
Current consumption, no-load		mA	
Maximum switching frequency	XS212SA●●●●	Hz	2500
	XS218SA●●●● and XS2L2●●●●	Hz	1000
	XS230SA●●●●	Hz	500
Delays	First-up	ms	≤ 10
	Response	ms	≤ 0.2 Ø 12, ≤ 0.3 Ø 18, ≤ 0.6 Ø 30
	Recovery	ms	≤ 0.2 Ø 12, ≤ 0.7 Ø 18, ≤ 1.4 Ø 30

(1) + 100 °C for cleaning and sterilization phases whilst not in service.

## Wiring schemes

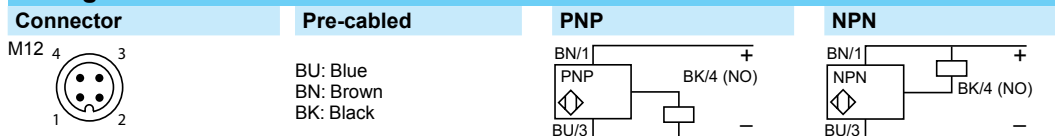

## Setting-up

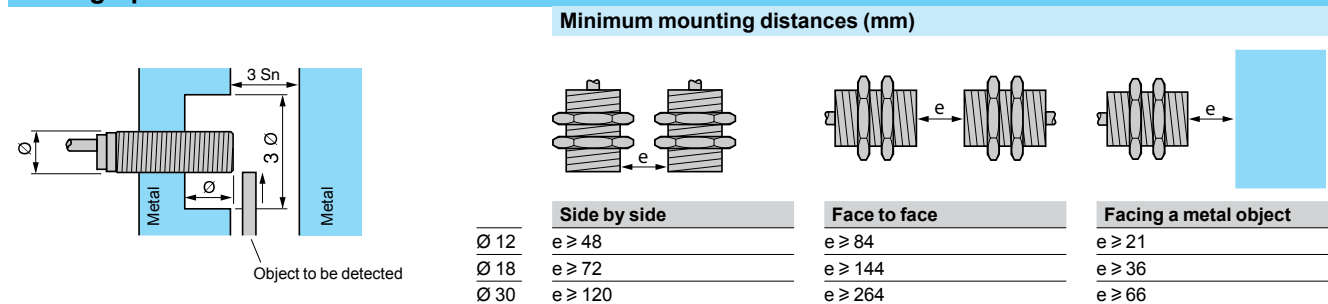

## Dimensions

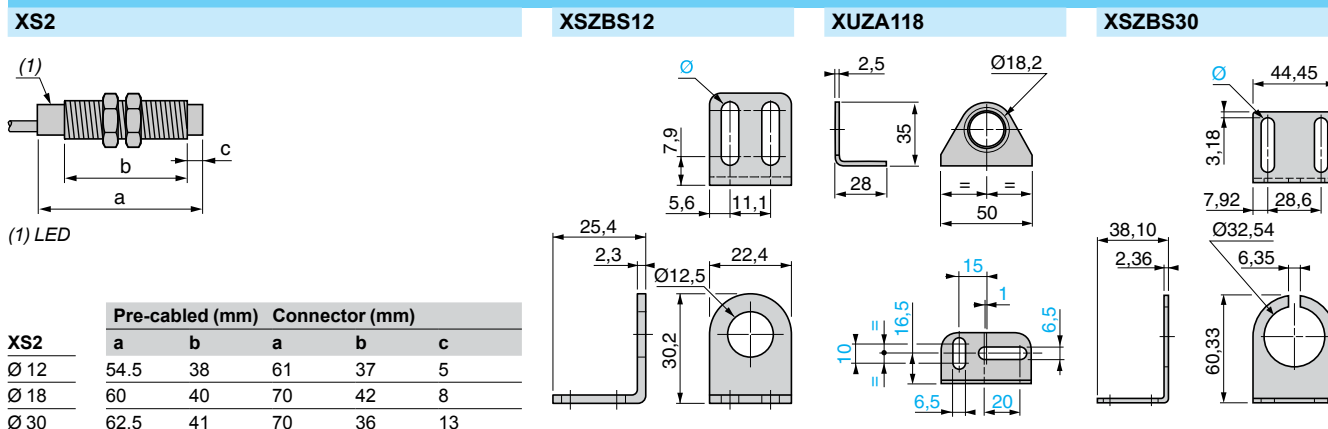

XS2	Pre-cabled (mm)		Connector (mm)		
	a	b	a	b	c
Ø 12	54.5	38	61	37	5
Ø 18	60	40	70	42	8
Ø 30	62.5	41	70	36	13

# Inductive proximity sensors

OsiSense Application, food and beverage processing series  
Cylindrical, stainless steel, non flush mountable  
Two-wire AC or DC

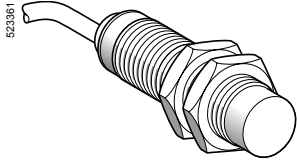

XS218SAM•L2

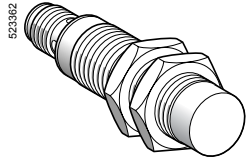

XS218SAM•U20

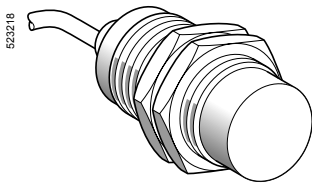

XS230SAM•L2

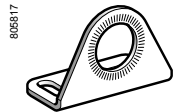

XUZA118

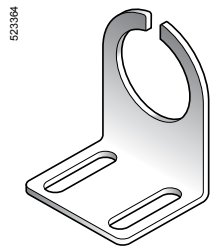

XSZBS30

### Ø 18, threaded M18 x 1

Sensing distance (Sn) mm	Function	Connection	Reference	Weight kg
12	NO	Pre-cabled (L = 2 m) (1)	<b>XS218SAMAL2</b>	0.120
		1/2"-20UNF connector	<b>XS218SAMAU20</b>	0.060

### Ø 30, threaded M30 x 1.5

Sensing distance (Sn) mm	Function	Connection	Reference	Weight kg
22	NO	Pre-cabled (L = 2 m) (1)	<b>XS230SAMAL2</b>	0.205
		1/2"-20UNF connector	<b>XS230SAMAU20</b>	0.145

### Connecting cables

Description	Type	Length m	Reference	Weight kg
<b>Pre-wired connectors</b> 1/2"-20UNF 3-pin female, stainless steel clamping ring	Straight	5	<b>XZCPA1865L5</b>	0.210
		10	<b>XZCPA1865L10</b>	0.410
	Elbowed	5	<b>XZCPA1965L5</b>	0.250
		10	<b>XZCPA1965L10</b>	0.485

### Accessories (2)

Description	For use with	Reference	Weight kg
<b>Stainless steel fixing bracket</b>	Ø 18 sensor	<b>XUZA118</b>	0.045
	Ø 30 sensor	<b>XSZBS30</b>	0.080

(1) For a 5 m long cable replace L2 by L5; for a 10 m long cable replace L2 by L10.

Example: **XS218SAMAL2** becomes **XS218SAMAL5** with a 5 m long cable.

(2) For further information, see page 128.

Characteristics		XS2●●SAM●U20	XS2●●SAM●L2
Sensor type			
Product certifications/approvals		UL, CSA, CE	
Connection	Connector	1/2"-20UNF	-
	Pre-cabled	-	Length: 2 m
Operating zone	Ø 18	<b>mm 0...9.6</b>	
	Ø 30	<b>mm 0...17.6</b>	
Differential travel		%	
		1...15 of effective sensing distance (Sr)	
Degree of protection	Conforming to IEC 60529	IP 67	IP 68, double insulation
	DIN 40050	IP 69K	
Storage temperature		°C	
		- 40...+ 85 (1)	
Operating temperature		°C	
		- 25...+ 85	
Materials	Case	Stainless steel 316 L	
	Cable	-	Non-poisonous PVC, 2 x 0.34 mm <sup>2</sup>
Vibration resistance		25 gn, amplitude ± 2 mm (f = 10 to 55 Hz)	
Shock resistance		50 gn, duration 11 ms	
Output state indication		Yellow LED: 4 viewing ports at 90°	Yellow LED: annular
Rated supply voltage		V	
		~ or - 24...240 (~ 50/60 Hz)	
Voltage limits (including ripple)		V	
		~ or - 20...264	
Switching capacity		mA	
		~ 5...300 or - 5...200 (2)	
Voltage drop, closed state		V	
		≤ 5.5	
Residual current, open state		mA	
		≤ 0.8	
Maximum switching frequency	XS218SAM●●●	Hz	
	XS230SAM●●●	Hz	
		~ 25 or - 1000	
		~ 25 or - 300	
Delays	First-up	ms	
	Response	ms	
	Recovery	ms	
		≤ 0.5 XS218SAM●●●, ≤ 2 XS230SAM●●●	

(1) + 100 °C for cleaning and sterilization phases whilst not in service.  
(2) It is essential to connect a 0.4 A "quick-blow" fuse in series with the load.

## Wiring schemes

Connector	Pre-cabled	2-wire ~ or -
1/2"-20UNF	BU: Blue BN: Brown	<b>NO output</b>
AC/DC: 2 ⊕ : 1 AC/DC: 3		⊕: on connector models only

## Setting-up

### Minimum mounting distances (mm)

	Side by side	Face to face	Facing a metal object
Ø 18	e ≥ 72	e ≥ 144	e ≥ 36
Ø 30	e ≥ 120	e ≥ 264	e ≥ 66

## Dimensions

XS2	XSZA118	XSZBS30

XS2	Pre-cabled (mm)		Connector (mm)		
	a	b	a	b	c
Ø 18	60	40	72	44	8
Ø 30	62.5	41	74	40	13

Ø: 2 elongated holes Ø 7.14 x 29.36



# Inductive proximity sensors

OsiSense Application, food and beverage processing series  
Cylindrical, plastic, non flush mountable  
Three-wire DC, solid-state output

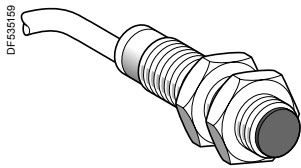

XS2●●AA●●L2

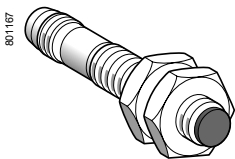

XS2●●AA●●M12

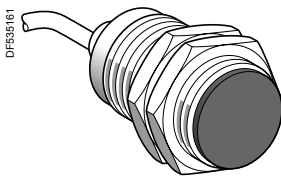

XS230AA●●L2

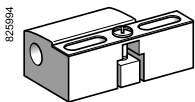

XSZB●●●

### Ø 12, threaded M12 x 1

Sensing distance (Sn) mm	Function	Output	Connection	Reference	Weight kg
7	NO	PNP	Pre-cabled (L = 2 m) (1)	<b>XS212AAPAL2</b>	0.065
			M12 connector	<b>XS212AAPAM12</b>	0.030
		NPN	Pre-cabled (L = 2 m) (1)	<b>XS212AANAL2</b>	0.065
			M12 connector	<b>XS212AANAM12</b>	0.030

### Ø 18, threaded M18 x 1

Sensing distance (Sn) mm	Function	Output	Connection	Reference	Weight kg
12	NO	PNP	Pre-cabled (L = 2 m) (1)	<b>XS218AAPAL2</b>	0.100
			M12 connector	<b>XS218AAPAM12</b>	0.040
		NPN	Pre-cabled (L = 2 m) (1)	<b>XS218AANAL2</b>	0.100
			M12 connector	<b>XS218AANAM12</b>	0.040

### Ø 30, threaded M30 x 1.5

Sensing distance (Sn) mm	Function	Output	Connection	Reference	Weight kg
22	NO	PNP	Pre-cabled (L = 2 m) (1)	<b>XS230AAPAL2</b>	0.140
			M12 connector	<b>XS230AAPAM12</b>	0.080
		NPN	Pre-cabled (L = 2 m) (1)	<b>XS230AANAL2</b>	0.140
			M12 connector	<b>XS230AANAM12</b>	0.080

### Accessories (2)

Description		Reference	Weight kg
Fixing clamps	Ø 12	<b>XSZB112</b>	0.006
	Ø 18	<b>XSZB118</b>	0.010
	Ø 30	<b>XSZB130</b>	0.020

### Connecting cables

Description	Type	Length m	Reference	Weight kg
Pre-wired M12 connectors Female, 4-pin, stainless steel clamping ring	Straight	2	<b>XZCPA1141L2</b>	0.090
		5	<b>XZCPA1141L5</b>	0.190
		10	<b>XZCPA1141L10</b>	0.370
	Elbowed	2	<b>XZCPA1241L2</b>	0.090
		5	<b>XZCPA1241L5</b>	0.190
		10	<b>XZCPA1241L10</b>	0.370
M12 jumper cable Male, 3-pin, stainless steel clamping ring	Straight	2	<b>XZCRA151140A2</b>	0.090
		5	<b>XZCRA151140A5</b>	0.190

(1) For a 5 m long cable replace L2 by L5; for a 10 m long cable replace L2 by L10.  
Example: **XS212AAPAL2** becomes **XS212AAPAL5** with a 5 m long cable.

(2) For further information, see page 128.

Characteristics		XS2●●AA●●M12	XS2●●AA●●L2
Sensor type		UL, CSA, CE	
Product certifications/approvals		UL, CSA, CE	
Connection	Connector	M12	–
	Pre-cabled	–	Length: 2 m
Operating zone	Ø 12	mm	0...5.6
	Ø 18	mm	0...9.6
	Ø 30	mm	0...17.6
Differential travel		%	1...15 of effective sensing distance (Sr)
Degree of protection	Conforming to IEC 60529	IP 67	IP 68, double insulation ☑
	DIN 40050	IP 69K	
Storage temperature		°C	-40...+85
Operating temperature		°C	-25...+85
Materials	Case	PPS	
	Cable	–	PvR and 3 x 0.34 mm <sup>2</sup>
Vibration resistance	Conforming to IEC 60068-2-6	25 gn, amplitude ± 2 mm (f = 10 to 55 Hz)	
Shock resistance	Conforming to IEC 60068-2-27	50 gn, duration 11 ms	
Output state indication		Yellow LED: annular	
Rated supply voltage		V	≈ 12...48 for T - 25...+85 °C
Voltage limits (including ripple)		V	≈ 10...58 for T - 25...+85 °C
Switching capacity		mA	≤ 200 with overload and short-circuit protection
Voltage drop, closed state		V	≤ 2
Current consumption, no-load		mA	≤ 10
Maximum switching frequency	XS212AA●●●●	Hz	2500
	XS218AA●●●●	Hz	1000
	XS230AA●●●●	Hz	500
Delays	First-up	ms	≤ 10
	Response	ms	≤ 0.2 Ø 12, ≤ 0.3 Ø 18, ≤ 0.6 Ø 30
	Recovery	ms	≤ 0.2 Ø 12, ≤ 0.7 Ø 18, ≤ 1.4 Ø 30

## Wiring schemes

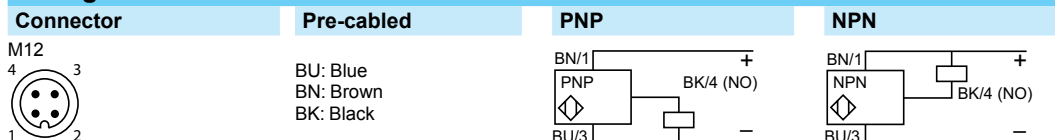

## Setting-up

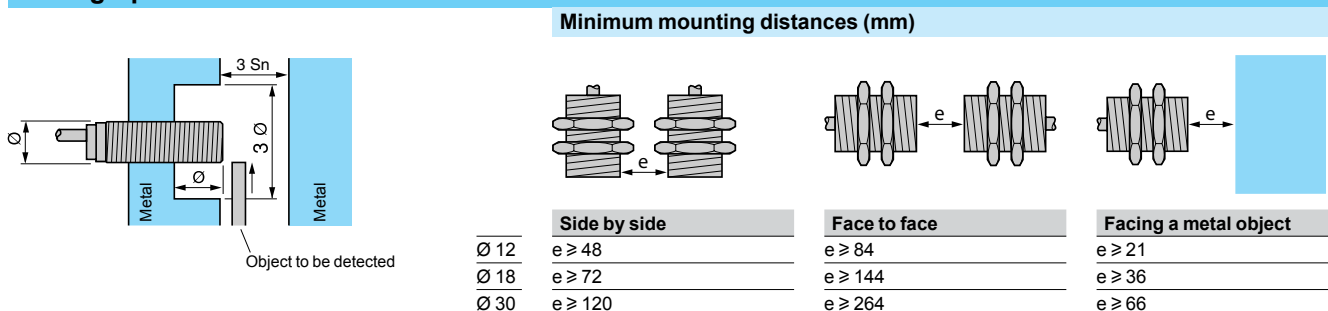

## Dimensions

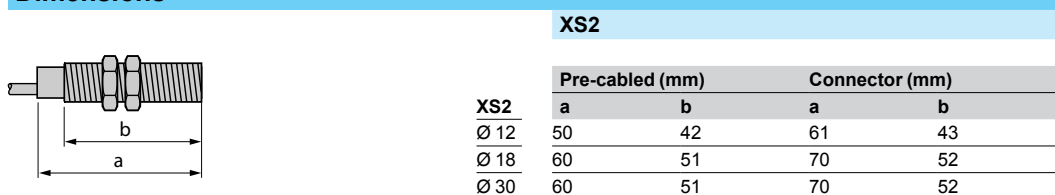

# Inductive proximity sensors

OsiSense XS Application, food and beverage processing series  
Cylindrical, plastic, non flush mountable  
Two-wire AC or DC

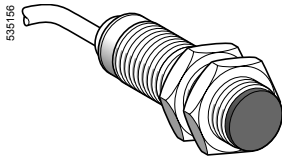

XS218AAM L2

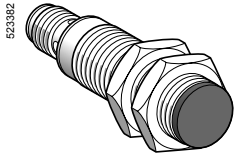

XS230AAM U20

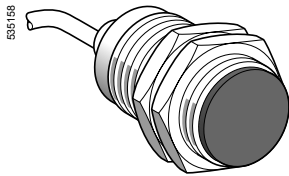

XS230AAM L2

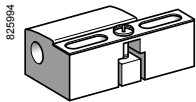

XSZB1

### Ø 18, threaded M18 x 1

Sensing distance (Sn) mm	Function	Connection	Reference	Weight kg
12	NO	Pre-cabled (L = 2 m) (1)	<b>XS218AAMAL2</b>	0.100
		1/2"-20UNF connector	<b>XS218AAMAU20</b>	0.040

### Ø 30, threaded M30 x 1.5

Sensing distance (Sn) mm	Function	Connection	Reference	Weight kg
22	NO	Pre-cabled (L = 2 m) (1)	<b>XS230AAMAL2</b>	0.140
		1/2"-20UNF connector	<b>XS230AAMAU20</b>	0.080

### Accessories (2)

Description		Reference	Weight kg
Fixing clamps	Ø 18	<b>XSZB118</b>	0.010
	Ø 30	<b>XSZB130</b>	0.020

### Connecting cables

Description	Type	Length m	Reference	Weight kg
Pre-wired connectors 1/2"-20UNF 3-pin female, stainless steel 316 L clamping ring	Straight	5	<b>XZCPA1865L5</b>	0.180
		10	<b>XZCPA1865L10</b>	0.350
	Elbowed	5	<b>XZCPA1965L5</b>	0.180
		10	<b>XZCPA1965L10</b>	0.350

(1) For a 5 m long cable replace L2 by L5; for a 10 m long cable replace L2 by L10.

Example: **XS218AAMAL2** becomes **XS218AAMAL5** with a 5 m long cable.

(2) For further information, see page 128.

# Inductive proximity sensors

OsiSense XS Application, food and beverage processing series

Cylindrical, plastic, non flush mountable  
Two-wire AC or DC

Characteristics		XS2●●AAM●U20	XS2●●AAM●L2
Sensor type		UL, CSA, CE	
Product certifications/approvals		UL, CSA, CE	
Connection	Connector	1/2"-20UNF	—
	Pre-cabled	—	Length: 2 m
Operating zone	∅ 18	<b>mm 0...9.6</b>	
	∅ 30	<b>mm 0...17.6</b>	
Differential travel		1...15 of effective sensing distance (Sr)	
Degree of protection	Conforming to IEC 60529	IP 67	IP 68, double insulation □
	DIN 40050	IP 69K	
Storage temperature		°C - 40...+ 85	
Operating temperature		°C - 25...+ 85	
Materials	Case	PPS	
	Cable	—	PvR and 2 x 0.34 mm <sup>2</sup>
Vibration resistance		25 gn, amplitude ± 2 mm (f = 10 to 55 Hz)	
Shock resistance		50 gn, duration 11 ms	
Output state indication		Yellow LED: annular	
Rated supply voltage		V ~ or ≐ 24...240 (~ 50/60 Hz)	
Voltage limits (including ripple)		V ~ or ≐ 20...264	
Switching capacity		mA ~ 5...300 or ≐ 5...200 (1)	
Voltage drop, closed state		V ≤ 5.5	
Residual current, open state		mA ≤ 0.8	
Maximum switching frequency	XS218AAM●●●	Hz ~ 25 or ≐ 1000	
	XS230AAM●●●	Hz ~ 25 or ≐ 300	
Delays	First-up	ms ≤ 30	
	Response	ms ≤ 0.5	
	Recovery	ms ≤ 0.5 XS218AAM●●●, ≤ 2 XS230AAM●●●	

(1) It is essential to connect a 0.4 A "quick-blow" fuse in series with the load.

## Wiring schemes

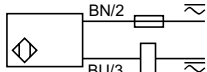
Connector	Pre-cabled	2-wire ~ or ≐
1/2"-20UNF	BU: Blue BN: Brown	<b>NO output</b>
		

## Setting-up

**Minimum mounting distances (mm)**

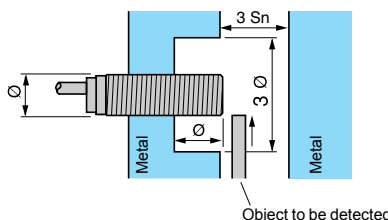

	Side by side	Face to face	Facing a metal object
∅ 18	e ≥ 72	e ≥ 144	e ≥ 36
∅ 30	e ≥ 120	e ≥ 264	e ≥ 66

## Dimensions

### XS2

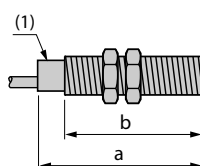

(1) LED

XS2	Pre-cabled (mm)		Connector (mm)	
	a	b	a	b
∅ 18	60	51	70	52
∅ 30	60	51	70	52

# Inductive proximity sensors

OsiSense XS Application  
Cylindrical, stainless steel 303 front face  
for harsh industrial environments  
Three-wire DC, solid-state output

DF513376

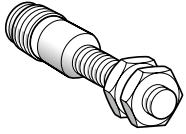

XS908●1PAM12

DF513389

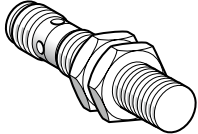

XS912●1PAM12

DF513373

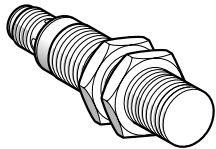

XS918●1PAM12

DF513380

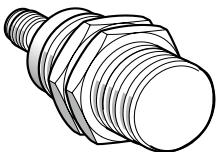

XS930●1PAM12

DF522604



XZCP1141L●

DF503630

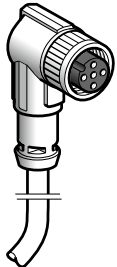

XZCP1241L●

## Ø 8 mm, threaded M8 x 1

Sensing distance (Sn) mm	Function	Output	Connection	Reference	Weight kg
<b>Three-wire 12-24V <math>\overline{\text{DC}}</math>, flush mountable</b>					
3	NO	PNP	M12	XS908R1PAM12	0.018

## Three-wire 12-24V $\overline{\text{DC}}$ , non flush mountable

6	NO	PNP	M12	XS908R4PAM12	0.018
---	----	-----	-----	--------------	-------

## Ø 12 mm, threaded M12 x 1

Sensing distance (Sn) mm	Function	Output	Connection	Reference	Weight kg
<b>Three-wire 12-24V <math>\overline{\text{DC}}</math>, flush mountable</b>					
6	NO	PNP	M12	XS912R1PAM12	0.024

## Three-wire 12-24V $\overline{\text{DC}}$ , non flush mountable

10	NO	PNP	M12	XS912R4PAM12	0.023
----	----	-----	-----	--------------	-------

## Ø 18 mm, threaded M18 x 1

Sensing distance (Sn) mm	Function	Output	Connection	Reference	Weight kg
<b>Three-wire 12-24V <math>\overline{\text{DC}}</math>, flush mountable</b>					
10	NO	PNP	M12	XS918R1PAM12	0.044

## Three-wire 12-24V $\overline{\text{DC}}$ , non flush mountable

20	NO	PNP	M12	XS918R4PAM12	0.051
----	----	-----	-----	--------------	-------

## Ø 30 mm, threaded M30 x 1.5

Sensing distance (Sn) mm	Function	Output	Connection	Reference	Weight kg
<b>Three-wire 12-24V <math>\overline{\text{DC}}</math>, flush mountable</b>					
20	NO	PNP	M12	XS930R1PAM12	0.140

## Three-wire 12-24V $\overline{\text{DC}}$ , non flush mountable

40	NO	PNP	M12	XS930R4PAM12	0.144
----	----	-----	-----	--------------	-------

## Connecting cables (PUR) (1)

Description	Type	Length m	Reference	Weight kg
<b>Pre-wired M12 connectors</b> Female, 4-pin Metal clamping	Straight	2	XZCP1141L2	0.090
		5	XZCP1141L5	0.190
		10	XZCP1141L10	0.370
	Elbowed	2	XZCP1241L2	0.090
		5	XZCP1241L5	0.190
		10	XZCP1241L10	0.370

## Wiring schemes

### M12 connector



### PNP

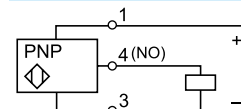

(1) For further information, please consult the catalogue "Cabling accessories OsiSense XZ", on our site [www.tesensors.com](http://www.tesensors.com).

# Inductive proximity sensors

OsiSense XS Application  
Cylindrical, stainless steel 303 front face  
for harsh industrial environments  
Three-wire DC, solid-state output

Characteristics						
Sensor type	Flush		XS908R1PAM12	XS912R1PAM12	XS918R1PAM12	XS930R1PAM12
	Non flush		XS908R4PAM12	XS912R4PAM12	XS918R4PAM12	XS930R4PAM12
Product certifications			CE, cULus			
Connection	Connector		M12			
Operating zone	Flush	mm	0...2.4	0...4.8	0...8	0...16
	Non flush	mm	0...4.8	0...8	0...16	0...32
Differential travel		%	1...15 (real sensing distance Sr)			
Degree of protection	Conforming to IEC 60529		IP 67	IP 68 (5 meters underwater for 1 month)		
	Conforming to DIN 40050		IP 69K			
Storage temperature		°C	-25...+70 (-13...158°F)			
Operating temperature		°C	-25...+70 (-13...158°F)			
Materials	Case		Stainless steel, 303 grade			
Front face thickness		mm	0.25	0.4	0.6	1.0
Mechanical shock resistance	Conforming to EN 50102		IK10			
Vibration resistance	Conforming to IEC 60068-2-6		25 gn, amplitude ± 1 mm (f = 10 to 55 Hz)			
Shock resistance	Conforming to IEC 60068-2-27		30 gn, duration 11 ms			
Output state indication			Yellow LED, 4 viewing points at 90° (blinking from 0.8 Sr and Sr)			
Rated supply voltage		V	12...24 with protection against reverse polarity			
Voltage limits (including ripple)		V	10...30			
Switching capacity		mA	≤ 200 with overload and short-circuit protection			
Voltage drop, closed state		V	≤ 2			
Current consumption, no-load		mA	≤ 10			
Maximum switching frequency	Flush	Hz	1000	600	300	100
	Non flush	Hz	700	400	200	90
Delays	First set-up	ms	40			
	Response	µs	0.05	0.06		
	Recovery	µs	23	15		

## Setting-up

### Minimum mounting distances in mm, flush version

Side by side		Face to face	Facing a metal object	Mounted in a metal support
Ø 8	e ≥ 14	e ≥ 15	e ≥ 10	d ≥ 12
Ø 12	e ≥ 38	e ≥ 30	e ≥ 20	d ≥ 24
Ø 18	e ≥ 42	e ≥ 40	e ≥ 30	d ≥ 50
Ø 30	e ≥ 80	e ≥ 70	e ≥ 60	d ≥ 90

### Minimum mounting distances in mm, non flush version

Side by side		Face to face	Facing a metal object	Mounted in a metal support
Ø 8	e ≥ 52	e ≥ 25	e ≥ 20	d ≥ 20 h ≥ 15
Ø 12	e ≥ 108	e ≥ 40	e ≥ 30	d ≥ 30 h ≥ 22
Ø 18	e ≥ 182	e ≥ 70	e ≥ 60	d ≥ 60 h ≥ 34
Ø 30	e ≥ 270	e ≥ 130	e ≥ 120	d ≥ 120 h ≥ 34

## Dimensions

	Flush sensor				Non flush sensor			
	M8	M12	M18	M30	M8	M12	M18	M30
a (mm)	66	60	63.5	63.5	66	60	63.5	63.5
b (mm)	46	41	42	42	42	36	35	32
c (mm)	0	0	0	0	4	5	7	10

Lengths (mm):  
a = overall  
b = threaded  
c = for non flush mountable sensors

## Reduction coefficient

Non flush mounted		Flush sensor				Non flush sensor			
		M8	M12	M18	M30	M8	M12	M18	M30
Steel		1	1	1	1	1	1	1	1
Aluminum		1	1	1	1	1	1	1	1
Brass		1.35	1.3	1.2	1.3	1.4	1.4	1.35	1.2
Copper		0.9	0.85	0.8	0.9	0.85	0.8	0.9	0.9
Stainless steel	Thickness 1 mm	0.3	0.5	0.5	0.35	0.3	(1)	0.3	(1)
	Thickness 2 mm	0.6	0.9	0.9	0.7	0.9	0.66	0.6	0.25
<b>Flush mounted</b>		<b>M8</b>	<b>M12</b>	<b>M18</b>	<b>M30</b>	(1) No detection.			
Steel		1	0.7	0.75	0.9				
Aluminum		0.9	1.15	0.9	0.7				
Brass		0.9	1.05	0.75	0.6				
Stainless steel		1	0.8	0.8	1.3				

# Inductive proximity sensors

OsiSense XS Application

For assembly, packaging and light material handling

Plastic case, 12 x 26 x 40 mm

DC supply, solid-state output

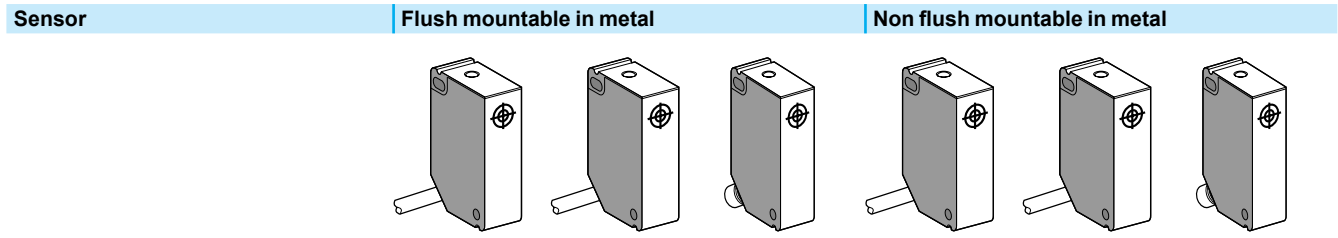

Nominal sensing distance (Sn)	2 mm	4 mm
-------------------------------	------	------

References							
3-wire $\overline{---}$	PNP NO	<b>XS7G12PA140</b>	–	<b>XS7G12PA140S</b>	<b>XS8G12PA140</b>	–	<b>XS8G12PA140S</b>
	NPN NO	<b>XS7G12NA140</b>	–	<b>XS7G12NA140S</b>	<b>XS8G12NA140</b>	–	<b>XS8G12NA140S</b>
4-wire $\overline{---}$ (complementary outputs)	PNP NO + NC	–	<b>XS7G12PC440</b>	–	–	<b>XS8G12PC440</b>	–
	NPN NO + NC	–	<b>XS7G12NC440</b>	–	–	<b>XS8G12NC440</b>	–
Weight (kg)		0.100	0.100	0.030	0.100	0.100	0.030

Characteristics							
Product certifications	CSA, UL, CE						
Connection	Pre-cabled	3 x 0.34 mm <sup>2</sup> , length 2 m (1)	4 x 0.34 mm <sup>2</sup> , length 2 m (1)	–	3 x 0.34 mm <sup>2</sup> , length 2 m (1)	4 x 0.34 mm <sup>2</sup> , length 2 m (1)	–
	Connector	–	–	M8	–	–	M8
Operating zone	<b>0...1.6 mm</b>			<b>0...3.2 mm</b>			
Repeat accuracy	≤ 10 % of Sr						
Differential travel	3...20 % of Sr						
Degree of protection	IP 67						
Storage temperature	- 40...+ 85 °C						
Operating temperature	- 25...+ 70 °C						
Materials	Case: PBT, cable: PVC						
Vibration resistance Conforming to IEC 60068-2-6	25 gn, amplitude ± 2 mm (f = 10 to 55 Hz)						
Shock resistance Conforming to IEC 60068-2-27	50 gn, duration 11 ms						
Output state indication	Yellow LED (on top of case)						
Rated supply voltage	$\overline{---}$ 12...24 V	$\overline{---}$ 12...48 V	$\overline{---}$ 12...24 V	$\overline{---}$ 12...24 V	$\overline{---}$ 12...48 V	$\overline{---}$ 12...24 V	$\overline{---}$ 12...24 V
Voltage limits (including ripple)	$\overline{---}$ 10...30 V	$\overline{---}$ 10...58 V	$\overline{---}$ 10...30 V	$\overline{---}$ 10...30 V	$\overline{---}$ 10...58 V	$\overline{---}$ 10...30 V	$\overline{---}$ 10...30 V
Current consumption, no-load	≤ 10 mA						
Switching capacity	0...100 mA (2)	0...200 mA (2)	0...100 mA (2)	0...100 mA (2)	0...200 mA (2)	0...100 mA (2)	0...100 mA (2)
Voltage drop, closed state	≤ 1.8 V	≤ 2.6 V	≤ 1.8 V	≤ 1.8 V	≤ 2.6 V	≤ 1.8 V	≤ 1.8 V
Maximum switching frequency	≤ 2 kHz			≤ 1 kHz			
Delays	First-up	≤ 4 ms					
	Response	≤ 0.5 ms					
	Recovery	≤ 1 ms					

(1) Sensors available with other cable lengths:

Length of cable	Suffix to be added to references stated above for 2 m pre-cabled sensors	Weight increase
5 m	<b>L1</b>	0.120 kg
10 m	<b>L2</b>	0.320 kg

Example: sensor **XS7G12PA140** with 5 m long cable becomes **XS7G12PA140L1**.

(2) With overload and short-circuit protection



# Inductive proximity sensors

OsiSense XS Application

For assembly, packaging and light material handling

Plastic case, 12 x 26 x 40 mm

DC supply, solid-state output

## Dimensions

XS● G12●A140, XS● G12●C440

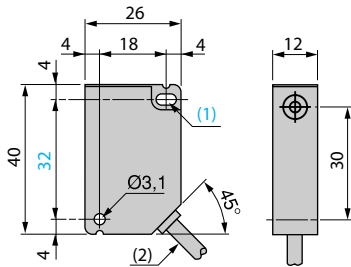

Rear view

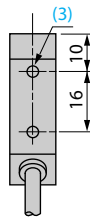

- (1) 1 elongated hole  $\varnothing 3.1 \times 5.1$ .
- (2) Cable  $L = 2\text{ m}$ .
- (3) 2 holes  $M3 \times 5$ .

XS● G12●A140S

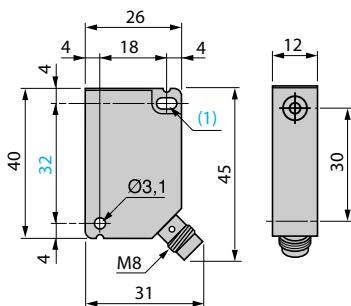

Rear view

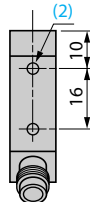

- (1) 1 elongated hole  $\varnothing 3.1 \times 5.1$ .
- (2) 2 holes  $M3 \times 5$ .

## Setting-up

Minimum mounting distances (mm)

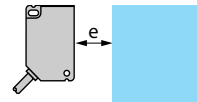
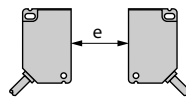
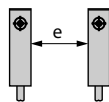

Side by side

Face to face

Facing a metal object and mounting in a metal support

XS7G flush mountable

$e \geq 0$

$e \geq 15$

$e \geq 6$

XS8G non flush mountable

$e \geq 10$

$e \geq 60$

$e \geq 12$

## Wiring schemes

3-wire  $\dots$ , NO output

4-wire  $\dots$ , NO + NC output

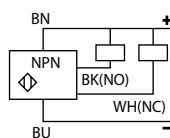
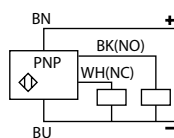
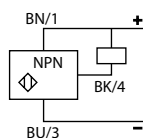
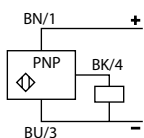

## Connector

M8



# Inductive proximity sensors

OsiSense XS Application

For assembly, packaging and light material handling

Plastic case, 12 x 26 x 40 mm

AC or DC supply

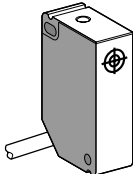
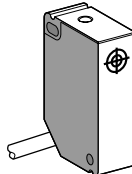
Sensor		Flush mountable in metal	Non flush mountable in metal
			
Nominal sensing distance (Sn)		2 mm	4 mm
<b>References</b>			
2-wire $\overline{\text{---}}$ or $\sim$	NO	<b>XS7G12MA230</b>	<b>XS8G12MA230</b>
	NC	<b>XS7G12MB230</b>	<b>XS8G12MB230</b>
Weight (kg)		0.100	0.100
<b>Characteristics</b>			
Product certifications		CSA, UL, CE	
Connection		Pre-cabled, 2 x 0.34 mm <sup>2</sup> , length 2 m (1)	
Operating zone		<b>0...1.6 mm</b>	<b>0...3.2 mm</b>
Repeat accuracy		≤ 10 % of Sr	
Differential travel		3...20 % of Sr	
Degree of protection		IP 67	
Storage temperature		- 40...+ 85 °C	
Operating temperature		- 25...+ 70 °C	
Materials		Case: PBT, cable: PVC	
Vibration resistance Conforming to IEC 60068-2-6		25 gn, amplitude ± 2 mm (f = 10 to 55 Hz)	
Shock resistance Conforming to IEC 60068-2-27		50 gn, duration 11 ms	
Output state indication		Yellow LED (on top of case)	
Rated supply voltage		$\sim$ 24...240 V (50/60 Hz) or $\overline{\text{---}}$ 24...210 V	
Voltage limits (including ripple)		$\sim$ or $\overline{\text{---}}$ 20...264 V	
Switching capacity		5...200 mA (2)	
Voltage drop, closed state		≤ 5.5 V	
Residual current, open state		≤ 0.8 mA/24 V, 1.5 mA/120 V	
Maximum switching frequency		$\sim$ 25 Hz or $\overline{\text{---}}$ 250 Hz	
Delays	First-up	≤ 40 ms	
	Response	≤ 1 ms	
	Recovery	≤ 2 ms	

(1) Sensors available with other cable lengths:

Length of cable	Suffix to be added to references stated above for 2 m pre-cabled sensors	Weight increase
5 m	<b>L1</b>	0.120 kg
10 m	<b>L2</b>	0.320 kg

Example: sensor **XS7G12MA230** with 5 m long cable becomes **XS7G12MA230L1**.

(2) These sensors do not incorporate overload or short-circuit protection and therefore, it is essential to connect a 0.4 A "quick-blow" fuse in series with the load.

# Inductive proximity sensors

OsiSense XS Application

For assembly, packaging and light material handling

Plastic case, 12 x 26 x 40 mm

AC or DC supply

## Dimensions

XS●G12M●230

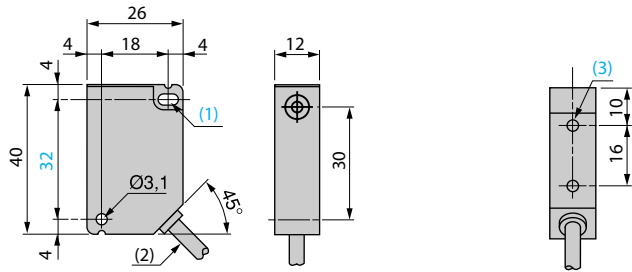

- (1) 1 elongated hole  $\varnothing 3.1 \times 5.1$ .
- (2) Cable  $L = 2\text{ m}$ .
- (3) 2 holes  $M3 \times 5$ .

## Setting-up

Minimum mounting distances (mm)

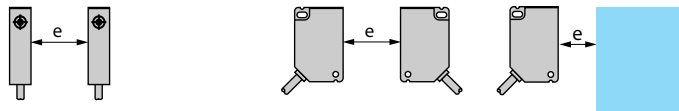

	Side by side	Face to face	Facing a metal object and mounting in a metal support
XS7G flush mountable	$e \geq 0$	$e \geq 15$	$e \geq 6$
XS8G non flush mountable	$e \geq 10$	$e \geq 60$	$e \geq 12$

## Wiring schemes

2-wire ~ or ---, NO or NC output

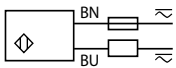

# Inductive proximity sensors

## OsiSense XS Application

Flat sensor, flush mountable, increased range, switching capacity 300 mA

80 x 80 x 40 format, DIN rail mounting, solid-state output

**Sensor** Flush mountable in metal

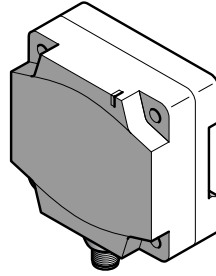

<b>Dimensions (mm)</b>	80 x 80 x 40
<b>Nominal sensing distance (Sn)</b>	50 mm (not flush mounted: 42 mm)

### References

<b>2-wire</b> $\overline{\text{---}}$ (non polarised)	NO	<b>XS7D1A3CAM12DIN</b>
<b>Weight (kg)</b>	0.374	

### Characteristics

<b>Product certifications</b>	CE; CSA, UL: pending	
<b>Degree of protection</b>	Conforming to IEC 60529	IP 67, double insulation $\square$
<b>Temperature</b>	Operating	- 25...+ 70 °C
	Storage	- 40...+ 85 °C
<b>Vibration resistance</b>	Conforming to IEC 60068-2-6	25 gn, amplitude $\pm$ 2 mm (f = 10 to 55 Hz)
<b>Shock resistance</b>	Conforming to IEC 60068-2-27	50 gn, duration 11 ms
<b>Connection</b>	M12 connector	
<b>Operating zone</b>	<b>0...40 mm (not flush mounted: 0...35 mm)</b>	
<b>Repeat accuracy</b>	3 % of Sr	
<b>Differential travel</b>	1...15 % of Sr	
<b>Output state indication</b>	Yellow LED	
<b>Rated supply voltage</b>	$\overline{\text{---}}$ 12...48 V with protection against reverse polarity	
<b>Voltage limits (including ripple)</b>	$\overline{\text{---}}$ 10...58 V	
<b>Residual current, open state</b>	$\leq$ 0.5 mA	
<b>Switching capacity</b>	<b>1.5...300 mA with overload and short-circuit protection</b>	
<b>Voltage drop, closed state</b>	$\leq$ 4.5 V	
<b>Maximum switching frequency</b>	100 Hz	
<b>Delays</b>	First-up	$\leq$ 10 ms
	Response	$\leq$ 2 ms
	Recovery	$\leq$ 5 ms

# Inductive proximity sensors

## OsiSense XS Application

Flat sensor, flush mountable, increased range, switching capacity 300 mA

80 x 80 x 40 format, DIN rail mounting, solid-state output

### Dimensions

XS7D1A3CAM12DIN

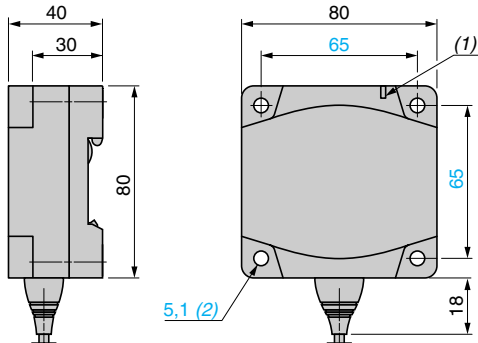

(1) Output LED

(2) For CHC type screws

### Setting-up

Minimum mounting distances (mm)

Face to face      Side by side      Back to back      Facing a metal object

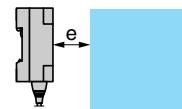
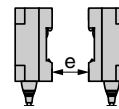
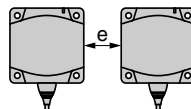
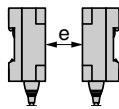

	Face to face	Side by side	Back to back	Facing a metal object
Flush mounted	450	140	90	150
Not flush mounted	450	180	180	150

### Flush/non flush conditions

In A37 steel

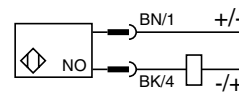
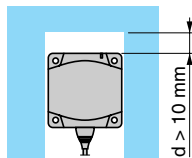
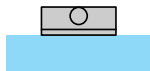

Sn	Su	Sn	Su
42 mm	35 mm	50 mm	40 mm

### Wiring schemes

2-wire NO/M12 XS7D1A3CAM12DIN

# Inductive proximity sensors

OsiSense XS Application  
Cylindrical, stainless steel 303 front face  
for welding environments  
Three-wire DC, solid-state output

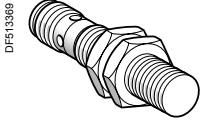

XS912RWPAM12

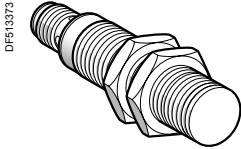

XS918RWPAM12

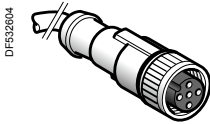

XZCP1141L●

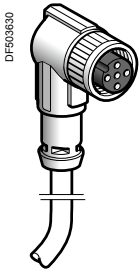

XZCP1241L●

## Ø 12 mm, threaded M12 x 1

Sensing distance (Sn) mm	Function	Output	Connection	Reference	Weight kg
<b>Three-wire 12-24V <math>\overline{\text{DC}}</math>, flush mountable</b>					
6	NO	PNP	M12	<b>XS912RWPAM12</b>	0.024

## Ø 18 mm, threaded M18 x 1

Sensing distance (Sn) mm	Function	Output	Connection	Reference	Weight kg
<b>Three-wire 12-24V <math>\overline{\text{DC}}</math>, flush mountable</b>					
10	NO	PNP	M12	<b>XS918RWPAM12</b>	0.051

## Connecting cables (PUR) (1)

Description	Type	Length m	Reference	Weight kg
<b>Pre-wired M12 connectors</b> Female, 4-pin Metal clamping ring	Straight	2	<b>XZCP1141L2</b>	0.090
		5	<b>XZCP1141L5</b>	0.190
		10	<b>XZCP1141L10</b>	0.370
	Elbowed	2	<b>XZCP1241L2</b>	0.090
		5	<b>XZCP1241L5</b>	0.190
		10	<b>XZCP1241L10</b>	0.370

## Wiring schemes

### M12 connector



### PNP

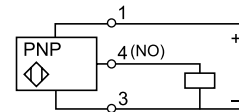

(1) For further information, please consult the catalogue "Cabling accessories OsiSense XZ" on our site [www.tesensors.com](http://www.tesensors.com).

# Inductive proximity sensors

OsiSense XS Application  
Cylindrical, stainless steel 303 front face  
for welding environments  
Three-wire DC, solid-state output

Characteristics			
Sensor type	Flush	XS912RWPAM12	XS918RWPAM12
Product certifications		CE, cULus	
Connection	Connector	M12	
Operating zone		mm	0...4.8
Differential travel		%	1...15 (real sensing distance Sr)
Degree of protection	Conforming to IEC 60529	IP 68 (5 meters underwater for 1 month)	
	Conforming to DIN 40050	IP 69K	
Storage temperature		°C	-25...+70 (-13...158°F)
Operating temperature		°C	-25...+70 (-13...158°F)
Materials	Case	Stainless steel, 303 grade	
Front face thickness		mm	0.4
Mechanical shock resistance	Conforming to EN 50102	IK10	
Vibration resistance	Conforming to IEC 60068-2-6	25 gn, amplitude ± 1 mm (f = 10 to 55 Hz)	
Shock resistance	Conforming to IEC 60068-2-27	30 gn, duration 11 ms	
Output state indication		Yellow LED, 4 viewing points at 90° (blinking from 0.8 Sr and Sr)	
Rated supply voltage		V	12...24 with protection against reverse polarity
Voltage limits (including ripple)		V	10...30
Switching capacity		mA	≤ 200 with overload and short-circuit protection
Voltage drop, closed state		V	≤ 2
Current consumption, no-load		mA	≤ 10
Maximum switching frequency		Hz	15
Delays	First set-up	ms	80
	Response	µs	100
	Recovery	µs	15

## Setting-up

### Minimum mounting distances in mm, flush version

#### Side by side

$$\frac{\varnothing 12}{\varnothing 18} \quad \begin{matrix} e \geq 38 \\ e \geq 42 \end{matrix}$$

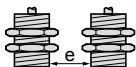

#### Face to face

$$\begin{matrix} e \geq 30 \\ e \geq 40 \end{matrix}$$

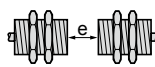

#### Facing a metal object

$$\begin{matrix} e \geq 20 \\ e \geq 30 \end{matrix}$$

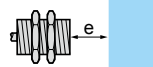

#### Mounted in a metal support

$$\begin{matrix} d \geq 24 \\ d \geq 50 \end{matrix}$$

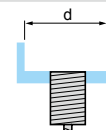

## Dimensions

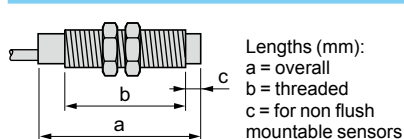

	Flush sensor	
	M12	M18
a (mm)	60	63.5
b (mm)	41	42
c (mm)	0	0

## Reduction coefficient

### Non flush mounted

		Flush sensor	
		M12	M18
Steel		1	1
Aluminum		1	1
Brass		1.3	1.2
Copper		0.85	0.8
Stainless steel	Thickness 1 mm	0.5	0.5
	Thickness 2 mm	0.9	0.9

### Flush mounted

	M12	M18
Steel	0.7	0.75
Aluminum	1.15	0.9
Brass	1.05	0.75
Stainless steel	0.8	0.8



# Inductive proximity sensors

## OsiSense XS Application

Sensors for welding machine applications <sup>(1)</sup>

Cylindrical type. Metal case, Teflon coated steel, threaded

### Sensors flush mountable in metal

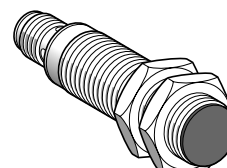
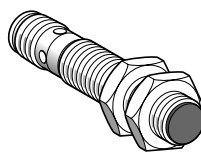
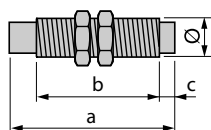

Lengths (mm):

a = Overall

b = Threaded section

c = For non flush mountable sensors

a = 60

b = 40

Ø = M12 x 1

a = 60

b = 40

Ø = M18 x 1

Nominal sensing distance (S <sub>n</sub> )	Teflon front face 2 mm	Teflon front face 5 mm
--	---------------------------	---------------------------

### References

3-wire $\overline{\text{---}}$	PNP, NO	XS1M12PAW01D	XS1M18PAW01D
Weight (kg)		0.025	0.060

### Characteristics

Product certifications	CE, UL, CSA	
Connection	M12 connector	
Degree of protection	Conforming to IEC 60529 IP 67	
Operating zone	0...1.6 mm	0...4 mm
Repeat accuracy	3 % of S <sub>r</sub>	
Differential travel	1...20 % of S <sub>r</sub>	
Operating temperature	- 25...+ 70 °C	
Output state indication	Yellow LED, 4 viewing ports at 90°	
Rated supply voltage	$\overline{\text{---}}$ 12...24 V with protection against reverse polarity	
Voltage limits (including ripple)	$\overline{\text{---}}$ 10...36 V	
Switching capacity	0...250 mA with overload and short-circuit protection	
Voltage drop, closed state	≤ 2.5 V	
Current consumption, no-load	≤ 15 mA	
Immunity to electromagnetic fields	≤ 140 mT	
Maximum switching frequency	1000 Hz	500 Hz
Delays	First-up	≤ 10 ms
	Response	≤ 0.1 ms
	Recovery	≤ 0.4 ms

### Wiring schemes

#### M12 connector

#### 3-wire $\overline{\text{---}}$ , PNP, NO output

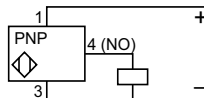

(1) Sensors particularly resistant to welding machine electromagnetic fields.

# Inductive proximity sensors

## OsiSense XS Application

Sensors for welding machine applications (1)

Cylindrical type. Metal case, Teflon coated steel, threaded

### Sensors non flush mountable in metal

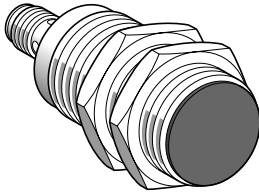

a = 60  
b = 40  
Ø = M30 x 1.5

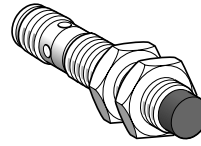

a = 60  
b = 36  
c = 4  
Ø = M12 x 1

<b>Teflon front face</b> 10 mm	<b>Teflon front face</b> 4 mm
-----------------------------------	----------------------------------

### References

<b>XS1M30PAW01D</b>	<b>XS2M12PAW01D</b>
0.145	0.025

### Characteristics

CE, UL, CSA	
<b>M12 connector</b>	
IP 67	
<b>0...8 mm</b>	<b>0...3.2 mm</b>
3 % of Sr	
1...20 % of Sr	
- 25...+ 70 °C	
Yellow LED, 4 viewing ports at 90°	
⎓ <b>12...24 V with protection against reverse polarity</b>	
⎓ 10...36 V	
<b>0...250 mA with overload and short-circuit protection</b>	
≤ 2.5 V	
≤ 15 mA	
≤ 140 mT	
250 Hz	1000 Hz
≤ 10 ms	≤ 10 ms
≤ 0.7 ms	≤ 0.2 ms
≤ 5 ms	≤ 0.4 ms

### Setting-up

Minimum mounting distances (mm)	Side by side	Face to face	Facing a metal object	Mounted in a metal support
---------------------------------	--------------	--------------	-----------------------	----------------------------

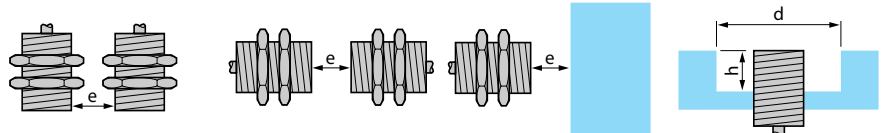

<b>XS1M12 flush mountable</b>	e ≥ 0	e ≥ 7	e ≥ 6	d ≥ 12, h ≥ 0
<b>XS1M18 flush mountable</b>	e ≥ 0	e ≥ 16	e ≥ 9	d ≥ 18, h ≥ 0
<b>XS1M30 flush mountable</b>	e ≥ 0	e ≥ 20	e ≥ 20	d ≥ 30, h ≥ 0
<b>XS2M12 non flush mountable</b>	e ≥ 15	e ≥ 9	e ≥ 11	d ≥ 36, h ≥ 8

Fixing nut tightening torque: XS1M12, XS2M12: < 15 N.m, XS1M18: < 35 N.m, XS1M30: < 50 N.m

## Flush mountable in metal

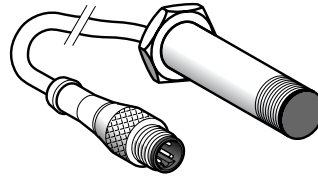
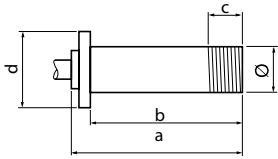

Lengths (mm):  
a = Overall  
b = To shoulder  
c = Removal  
d = Shoulder

$\varnothing = 12$   
a = 55  
b = 50  
c = 9 (threaded end)  
d = 15 hexagonal

Nominal sensing distance (Sn)	3 mm	3 mm	3 mm
-------------------------------	------	------	------

## References

2-wire $\overline{\text{---}}$ (non polarised) Terminal connections	1-4	NO	XSLC1401393L1	XSLC1401393L3	XSLC1401393L4
Weight (kg)			0.050	0.065	0.050

## Characteristics

Connection	Remote M12 connector on 1.2 m flying lead	Remote M12 connector on 0.8 m flying lead	Remote M12 connector on 0.15 m flying lead
Degree of protection conforming to IEC 60529	IP 67		
Operating zone	0...2.4 mm		
Repeat accuracy	$\leq 3\%$ of Sr		
Differential travel	1...15 % of Sr		
Operating temperature	- 25...+ 80 °C		
Output state indication	Yellow LED, annular		
Rated supply voltage	$\overline{\text{---}}$ 12...48 V		
Voltage limits (including ripple)	$\overline{\text{---}}$ 10...58 V		
Switching capacity	1.5... 100 mA with overload and short-circuit protection		
Voltage drop, closed state	$\leq 4$ V		
Residual current, open state	$\leq 0.5$ mA		
Current consumption, no-load	-		
Maximum switching frequency	800 Hz		
Delays	First-up: $\leq 5$ ms; response: $\leq 05$ ms; recovery: $\leq 0.5$ ms		

## Wiring schemes

2-wire  $\overline{\text{---}}$ , non polarised, NO output

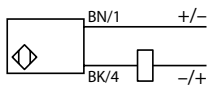

### Flush mountable in metal

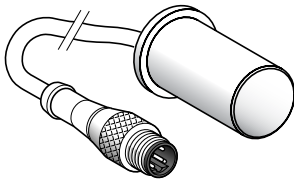

$\varnothing = 18$   
 $a = 40$   
 $b = 35$   
 $c = 0$  (PPS front face)  
 $d = \varnothing 22$

### Non flush mountable in metal

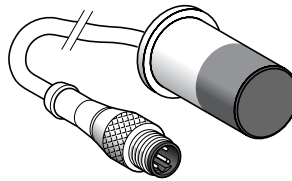

$\varnothing = 18$   
 $a = 45$   
 $b = 35$   
 $c = 20$  (Teflon front face and case)  
 $d = \varnothing 22$

6.3 mm

10 mm

10 mm

### References

XSLC1401392L1

XSLC1401405L3

XSLC1401405L4

0.100

0.065

0.050

### Characteristics

Remote M12 connector on 1.2 m flying lead

Remote M12 connector on 0.8 m flying lead

Remote M12 connector on 0.15 m flying lead

IP 67

0...5 mm

0...8 mm

3 % of Sr

1...15 % of Sr

-25...+70 °C

Yellow LED, annular

~ 12...48 V

~ 10...58 V

1.5...100 mA with overload and short-circuit protection

≤ 4 V

≤ 0.5 mA

-

100 Hz

First-up: ≤ 10 ms; response: ≤ 10 ms; recovery: ≤ 2 ms

### Setting-up

#### Minimum mounting distances (mm)

Side by side

Face to face

Facing a metal object

Mounted in a metal support

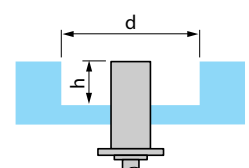
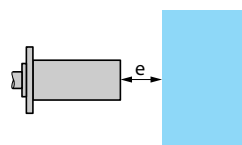
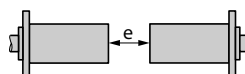
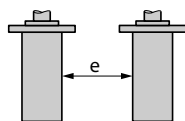

XSLC  $\varnothing 12$  (flush mountable)

$e \geq 10$

$e \geq 60$

$e \geq 15$

$d = 12, h = 0$

$\varnothing 18$  (non flush mountable)

$e \geq 16$

$e \geq 96$

$e \geq 24$

$d = 54, h = 16$

# Inductive proximity sensors

## OsiSense XS

Detection at fixed sensing distance. Factor 1 (Fe/Nfe) sensors <sup>(1)</sup> for ferrous and non ferrous materials  
Solid-state output

### Flush mountable in metal

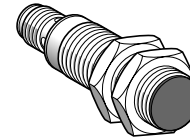
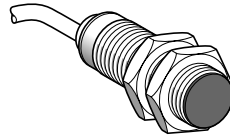
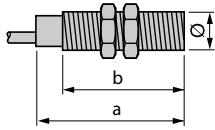

Lengths (mm):  
a = Overall  
b = Threaded section

a = 60  
b = 51.5  
Ø = M18 x 1

a = 70  
b = 51.5  
Ø = M18 x 1

	Brass case	Brass case
Nominal sensing distance (Sn)	5 mm	5 mm

### References

4-wire ☐	PNP/PNP programmable NO/NC	XS1M18KPM40	XS1M18KPM40D
Weight (kg)		0.120	0.060

### Characteristics

Product certifications	CE, UL, CSA	
Connection	Pre-cabled, PvR 4 x 0.34 mm <sup>2</sup> , length 2 m <sup>(2)</sup>	M12 connector
Degree of protection	Conforming to IEC 60529	IP 68
Operating zone	0...4 mm	
Repeat accuracy	3 % of Sr	
Differential travel	1...15 % of Sr	
Operating temperature	0...+50 °C	
Output state indication	Yellow LED, annular	Yellow LED, 4 viewing ports at 90°
Rated supply voltage	☐ 12...24 V with protection against reverse polarity	
Voltage limits (including ripple)	☐ 10...38 V	
Switching capacity	0...200 mA with overload and short-circuit protection	
Voltage drop, closed state	≤ 2.6 V	
Current consumption, no-load	≤ 15 mA	
Maximum switching frequency	1000 Hz	
Delays	First-up	≤ 10 ms
	Response	≤ 0.3 ms
	Recovery	≤ 0.7 ms

### Wiring schemes

M12 connector	Pre-cabled	4-wire ☐, PNP/NPN, NO or NC output	
		NO	NC
	BN: brown BU: blue BK: black WH: white		

<sup>(1)</sup> The variation in sensing distance between ferrous and non ferrous materials is typically less than 5 %.

<sup>(2)</sup> Sensors available with other cable lengths: please consult our Customer Care Centre.

# Inductive proximity sensors

## OsiSense XS

Detection at fixed sensing distance. Factor 1 (Fe/Nfe) sensors <sup>(1)</sup> for ferrous and non ferrous materials  
Solid-state output

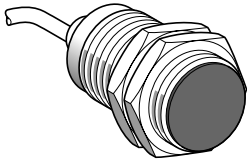

a = 60  
b = 51.5  
Ø = M30 x 1.5

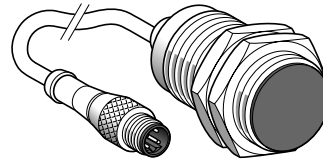

a = 60  
b = 51.5  
Ø = M30 x 1.5

<b>Stainless steel case</b> 10 mm	<b>Stainless steel case</b> 10 mm
--------------------------------------	--------------------------------------

<b>References</b>	
<b>XS1M30KPM40</b>	<b>XS1M30KPM40LD</b>
0.205	0.145

<b>Characteristics</b>	
CE, UL, CSA	
Pre-cabled, PvR 4 x 0.34 mm <sup>2</sup> , length 2 m (2)	M12 connector on 0.8 m flying lead
IP 68	IP 67
<b>0...8 mm</b>	
3 % of Sr	
1...15 % of Sr	
0...+ 50 °C	
Yellow LED, annular	
--- 12...24 V with protection against reverse polarity	
--- 10...38 V	
<b>0...200 mA with overload and short-circuit protection</b>	
≤ 2.6 V	
≤ 15 mA	
1000 Hz	
≤ 5 ms	
≤ 0.3 ms	
≤ 0.7 ms	

<b>Setting-up</b>				
Minimum mounting distances (mm)	Side by side	Face to face	Facing a metal object	Mounted in a metal support

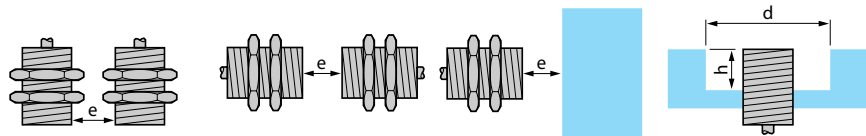

<b>XS1M18 flush mountable</b>	e ≥ 10	e ≥ 60	e ≥ 15	d ≥ 18, h ≥ 0
<b>XS1M30 flush mountable</b>	e ≥ 20	e ≥ 120	e ≥ 30	d ≥ 30, h ≥ 0

Fixing nut tightening torque: XS1M18: < 35 N.m, XS1M30: < 100 N.m

(1) The variation in sensing distance between ferrous and non ferrous materials is typically less than 5 %.  
(2) Sensors available with other cable lengths: please consult our Customer Care Centre.

# Inductive proximity sensors

## OsiSense XS Application

Factor 1 sensors for ferrous or non ferrous material detection and welding applications. Plastic case, 40 x 40 mm front face. 5 position turret head

<b>Sensor</b>	<b>Flush mountable in metal</b>	
<b>Dimensions</b>	<b>40 x 40 x 70 mm</b>	<b>40 x 40 x 117 mm</b>

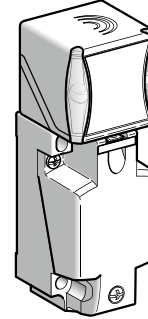
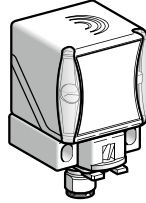

<b>Nominal sensing distance (Sn)</b>	20 mm
--------------------------------------	-------

### References

<b>4-wire</b> $\text{---}$	PNP NO+NC	<b>XS9C2A1PCM12</b>	<b>XS9C4A1PCP20 (1)</b>
	NPN NO+NC	<b>XS9C2A1NCM12</b>	<b>XS9C4A1NCP20 (1)</b>

**XS9C4●●●P20** sensors are available with an ISO M20 cable entry and can be supplied with a Pg 13.5 (e.g. **XS9C4A1PCG13**) or a 1/2" NPT (e.g. **XS9C4A1PCN12**) cable entry: please consult our Customer Care Centre for more information.

<b>Weight (kg)</b>	0.110	0.220
--------------------	-------	-------

### Characteristics

<b>Product certifications</b>	UL, CSA, CE	
<b>Conformity to standards</b>	IEC 60947-5-2	
<b>Connection</b>	M12 connector (4-pin)	Screw terminals, clamping capacity 4 x 1.5 mm <sup>2</sup> / 4 x 16 AWG
<b>Operating zone</b>	0...16 mm	
<b>Differential travel</b>	3...15% of Sr	
<b>Repeat accuracy</b>	< 3%	
<b>Immunity to magnetic fields</b>	< 250 mTesla	
<b>Degree of protection</b>	Conforming to IEC 60529 and DIN 40050	IP 65, IP 67 and IP 69K
<b>Temperature</b>	Storage	- 40...+ 85°C
	Operation (2)	- 25...+ 70°C
<b>Material</b>	Case: PBT	
<b>Vibration resistance</b>	Conforming to IEC 60068-2-6	25 gn, amplitude $\pm$ 2 mm (f = 10...55 Hz)
<b>Shock resistance</b>	Conforming to IEC 60068-2-27	50 gn for 11 ms
<b>Indicators</b>	Output state: yellow LED. Supply on: green LED	
<b>Rated supply voltage</b>	4-wire $\text{---}$	$\text{---}$ 12...24 V with protection against reverse polarity
<b>Voltage limits (including ripple)</b>	4-wire $\text{---}$	$\text{---}$ 10...36 V
<b>Current consumption, no-load</b>	4-wire $\text{---}$	< 30 mA
<b>Switching capacity</b>	4-wire $\text{---}$	< 200 mA with protection against overload and short-circuit
<b>Voltage drop, closed state</b>	4-wire $\text{---}$	< 2 V
<b>Maximum switching frequency</b>	4-wire $\text{---}$	250 Hz
<b>Delays</b>	First-up	< 15 ms
	Response	< 2.5 ms
	Recovery	< 2.5 ms

### Setting-up

**Sensing distance correction factor**

SS: stainless steel, Fe: steel, Al: aluminium, Cu: copper.

**Operating distance (according to the sensor's level of flush mounting)**

--- : Flush mounted in Fe360 — : Flush mounted in aluminium

(1) These sensors are supplied without a cable gland. A suitable Pg 13.5 cable gland is available (reference **XSZPE13**).  
 (2) Sensors are available for very low temperatures (suffix **TF**: - 40°C, + 70°C) or very high temperatures (suffix **TT**: - 25°C, + 85°C); please consult our Customer Care Centre.



# Inductive proximity sensors

## OsiSense XS Application

Factor 1 sensors for ferrous or non ferrous material detection and welding applications. Plastic case, 40 x 40 mm front face. 5 position turret head

### Setting-up (continued)

#### Minimum mounting distances (mm)

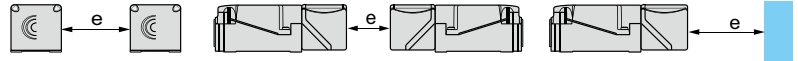

Side by side

Face to face

Facing a metal object

Sensors flush mountable in metal

$e \geq 80$

$e \geq 200$

$e \geq 60$

### Wiring schemes

#### M12 connector



1: + V  
2: NC Output  
3: 0 V  
4: NO Output

#### 4-wire $\overline{NPN}$ , NO + NC outputs

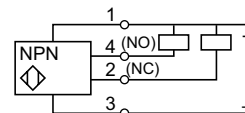
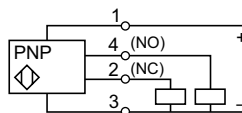

### Accessories

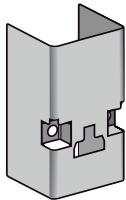

XSZPSC2

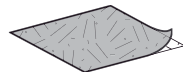

XSZPKC2

Description	Use for	Reference	Weight kg
<b>Stainless steel rigid protective cover</b> (only suitable for use when detecting from the top)	Welding	<b>XSZPSC2</b>	0.010
<b>Protective sheet</b> (for sensing face of sensor)	Welding	<b>XSZPKC2</b>	0.010

[Sold in lots of 5](#)

### Dimensions

#### XS9C2A1PCM12 and XS9C2A1NCM12

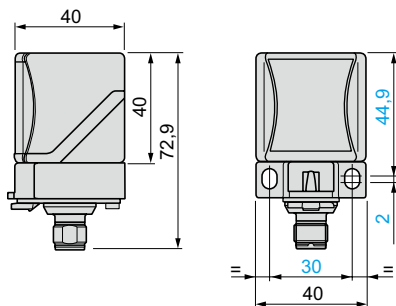

### Head positions

#### XS9C2A1PCM12 and XS9C2A1NCM12

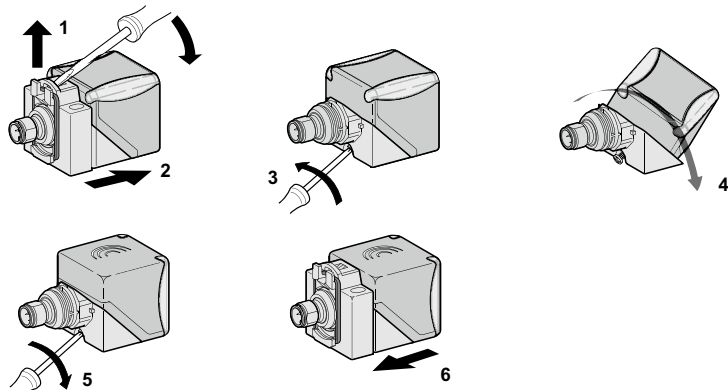

#### XS9C4A1PCP20 and XS9C4A1NCP20

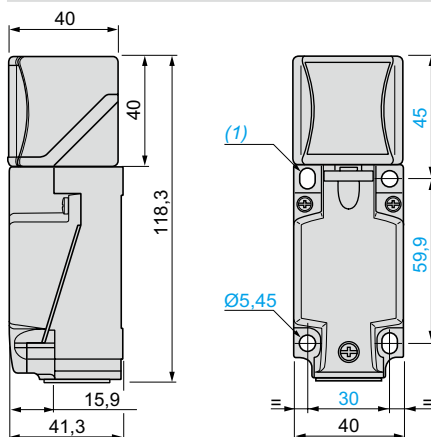

#### XS9C4A1PCP20 and XS9C4A1NCP20

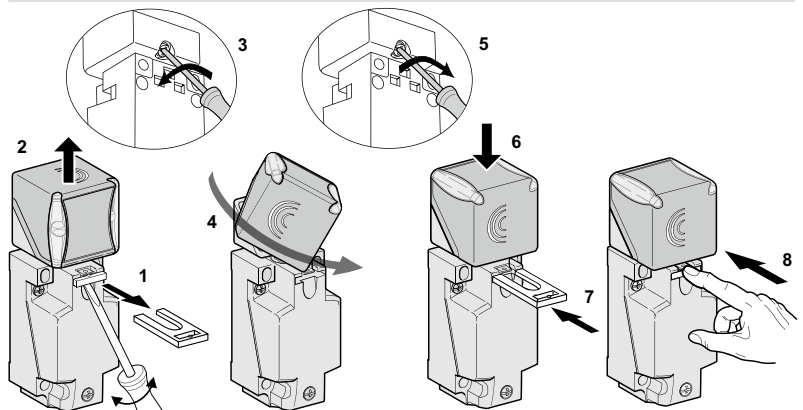

(1) 2 elongated holes  $\varnothing 5.3 \times 7$  mm.

Tightening torque of cover fixing screws and clamp screws:  $< 1.2$  N.m /  $< 10.62$  lb-in.

## Inductive proximity sensors

### OsiSense XS Application

Fixed sensing distance detection, Factor 1 (Fe/Nfe) sensors <sup>(1)</sup> for ferrous and non ferrous materials  
Solid-state output

Sensor	Flush mountable in metal
--------	--------------------------

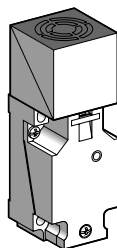

Nominal sensing distance (Sn)	15 mm
-------------------------------	-------

### References

4-wire $\overline{\text{---}}$	PNP/NPN/NO/NC programmable	<b>XS7C40KPM40</b>
--------------------------------	----------------------------	--------------------

Weight (kg)	0.220
-------------	-------

### Characteristics

Product certifications		CE, CSA, UL
Degree of protection	Conforming to IEC 60529	IP 67
Operating temperature		0...+ 50 °C
Connection		Screw terminals, clamping capacity 4 x 0.34 mm <sup>2</sup> (2)
Operating zone		<b>0...12 mm</b>
Repeat accuracy		3 % of Sr
Differential travel		1...15 % of Sr
Output state indication		Yellow LED
Rated supply voltage		$\overline{\text{---}}$ 12...24 V with protection against reverse polarity
Voltage limits (including ripple)		$\overline{\text{---}}$ 10...36 V
Current consumption, no-load		≤ 15 mA
Switching capacity		0...200 mA with overload and short-circuit protection
Voltage drop, closed state		≤ 2.6 V
Maximum switching frequency		1000 Hz
Delays	First-up	≤ 5 ms
	Response	≤ 0.3 ms
	Recovery	≤ 0.7 ms

(1) The variation in sensing distance between ferrous and non ferrous materials is typically less than 5 %.

(2) Cable gland not included with sensor. For suitable 13P cable gland (XSZPE13), see page 128.

# Inductive proximity sensors

## OsiSense XS Application

Fixed sensing distance detection, Factor 1 (Fe/Nfe) sensors <sup>(1)</sup> for ferrous and non ferrous materials  
Solid-state output

### Dimensions

XS7C40KPM40

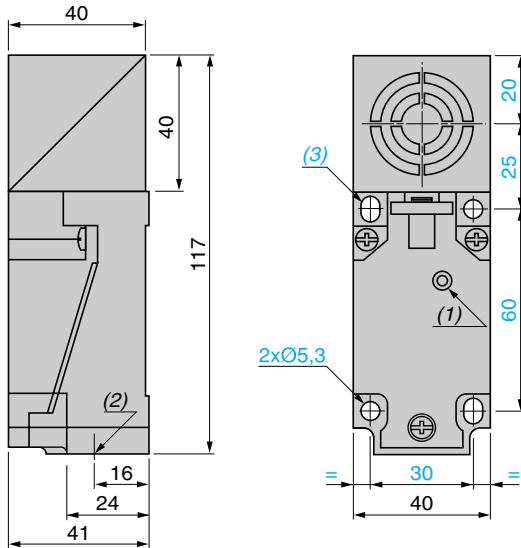

(1) Output LED.

(2) 1 tapped entry for 13P cable gland.

(3) 2 elongated holes  $\varnothing 5.3 \times 7$ .

### Setting-up

#### Minimum mounting distances (mm)

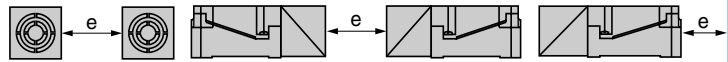

Sensor flush mountable in metal	XS7C40KPM40	Side by side $e \geq 40$	Face to face $e \geq 120$	Facing a metal object $e \geq 45$
---------------------------------	-------------	-----------------------------	------------------------------	--------------------------------------

Tightening torque of cover fixing screws and clamp screws:  $< 1.2 \text{ N.m}$

### Wiring schemes

#### PNP/NPN

4-wire  $\square$  programmable, NO or NC output

NO output

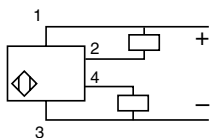

NC output

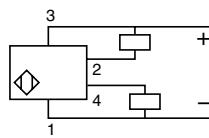

# Inductive proximity sensors

## OsiSense XS Application

Selective detection of ferrous materials

Selective detection of non ferrous materials

Cylindrical type, solid-state output

### Flush mountable

Stainless steel case

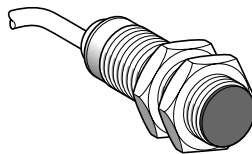

Nominal sensing distance (Sn) 5 mm

### References

3-wire, ferrous version Insensitive to non ferrous materials	PNP NO	<b>XS1M18PAS40</b>
3-wire, non ferrous version Insensitive to ferrous materials	PNP NO	<b>XS1M18PAS20</b>
Weight (kg)		0.120

### Characteristics

Product certifications	UL, CSA, CE	
Connection	Pre-cabled, PvR, 3 x 0.34 mm <sup>2</sup> , length 2 m (1)	
Operating zone	0...4 mm	
Degree of protection conforming to IEC 60529	IP 68	
Operating temperature	-25...+70 °C	
Output state indication	Yellow LED, annular	
Rated supply voltage	DC 12...24 V with protection against reverse polarity	
Voltage limits (including ripple)	DC 10...38 V	
Switching capacity	0...200 mA with overload and short-circuit protection	
Voltage drop, closed state	≤ 2.6 V	
Residual current, open state	–	
Current consumption, no-load	≤ 15 mA	
Maximum switching frequency	1000 Hz	
Delays	First-up	≤ 10 ms
	Response	≤ 0.3 ms
	Recovery	≤ 0.7 ms

(1) Sensors available with other cable lengths: please consult our Customer Care Centre.

### Wiring schemes

3-wire DC PNP

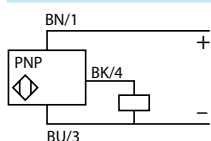

### Dimensions

XS1M

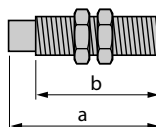

a (mm)	b (mm)
60	51.5

### Setting-up

Minimum mounting distances (mm)

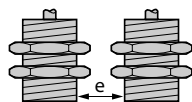

Side by side

$e \geq 10$

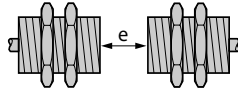

Face to face

$e \geq 60$

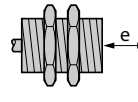

Facing a metal object

$e \geq 15$

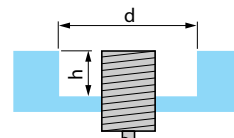

Mounted in a metal support

$d \geq 18, h \geq 0$  (ferrous metal)  
 $d \geq 18, h \geq 5$  (non ferrous metal)

XS1M18

# Inductive proximity sensors

## OsiSense XS Application

Selective detection of ferrous materials

Selective detection of non ferrous materials

Cylindrical type, solid-state output

### Flush mountable

Stainless steel case

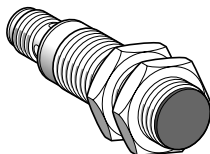

Nominal sensing distance (Sn) 5 mm

### References

3-wire, ferrous version Insensitive to non ferrous materials	PNP NO	<b>XS1M18PAS40D</b>
3-wire, non ferrous version Insensitive to ferrous materials	PNP NO	<b>XS1M18PAS20D</b>
Weight (kg)		0.060

### Characteristics

Product certifications	UL, CSA, CE
Connection	M12 connector
Degree of protection conforming to IEC 60529	IP 67
Operating zone	0...4 mm
Operating temperature	-25...+70 °C
Output state indication	Yellow LED, 4 viewing ports at 90°
Rated supply voltage	12...24 V with protection against reverse polarity
Voltage limits (including ripple)	10...38 V
Switching capacity	0...200 mA with overload and short-circuit protection
Voltage drop, closed state	≤ 2.6 V
Residual current, open state	–
Current consumption, no-load	≤ 15 mA
Maximum switching frequency	1000 Hz
Delays	
First-up	≤ 10 ms
Response	≤ 0.3 ms
Recovery	≤ 0.7 ms

### Wiring schemes

M12 connector

3-wire PNP

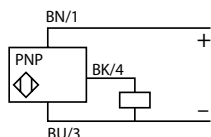

### Dimensions

XS1M

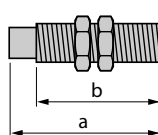

a (mm)	b (mm)
70	51.5

### Setting-up

Minimum mounting distances (mm)

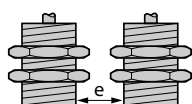

Side by side

$e \geq 10$

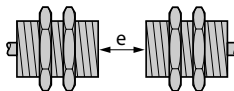

Face to face

$e \geq 60$

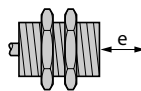

Facing a metal object

$e \geq 15$

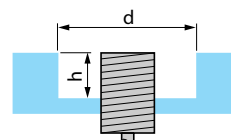

Mounted in a metal support

$d \geq 18, h \geq 0$  (ferrous metal)  
 $d \geq 18, h \geq 5$  (non ferrous metal)

XS1M18

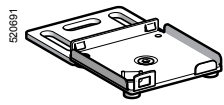

XSZB00

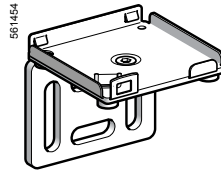

XSZB90

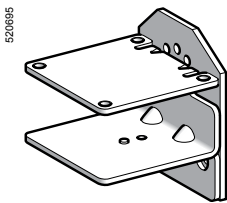

XSZBC10

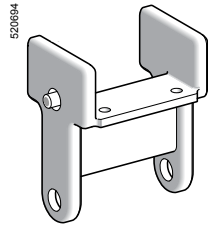

XSZBE10

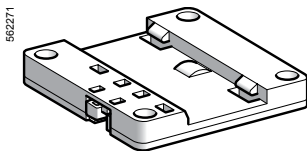

XSZBD10

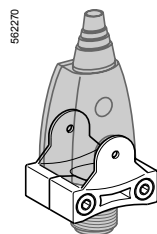

XSZBPM12

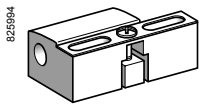

XSZB100

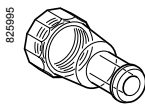

XSZP100

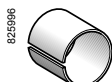

XSZA00

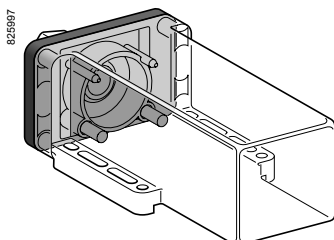

XSCZ01

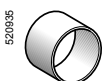

XSZF10

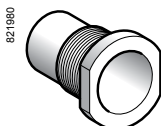

XTAZ30

### Mounting and fixing accessories

Description	For use with sensor		Unit reference	Weight kg	
	Type	Diameter (mm)			
<b>"Clip" mounting plate</b> Can be mounted without "clip" on threaded holes	XS●J	–	<b>XSZBJ00</b>	0.003	
	XS●F	–	<b>XSZBF00</b>	0.005	
	XS●E	–	<b>XSZBE00</b>	0.025	
	XS●C	–	<b>XSZBC00</b>	0.060	
<b>"Clip" 90° mounting bracket</b> Can be mounted without "clip" on threaded holes	XS●J	–	<b>XSZBJ90</b>	0.003	
	XS●F	–	<b>XSZBF90</b>	0.005	
	XS●E	–	<b>XSZBE90</b>	0.025	
	XS●C	–	<b>XSZBC90</b>	0.060	
<b>Replacement bracket</b>	XS●E	–	<b>XSZBE10</b>	0.060	
	Replaces: XS7T2, XS8T2, XSE				
	XS●C	–	<b>XSZBC10</b>	0.110	
	Replaces: XS7T4, XS7C40, XS8T4, XS8C40 and XSC				
	XS●D (for XSD) (1)	–	<b>XSZBD10</b>	0.065	
<b>Fixing clamp for remote control</b>	XS9, XS6●●●B2	–	<b>XSZBPM12</b>	0.015	
<b>Fixing clamps</b>	XS1	4 (plain)	<b>XSZB104</b>	0.005	
		5 (M5 x 0.5)	<b>XSZB105</b>	0.005	
	XS1, XS2	6.5 (plain)	<b>XSZB165</b>	0.005	
		8 (M8 x 1)	<b>XSZB108</b>	0.006	
	XS1, XS2, XS4, XS5, XS6	12 (M12 x 1)	<b>XSZB112</b>	0.006	
		18 (M18 x 1)	<b>XSZB118</b>	0.010	
	XS1, XS2, XS4, XS5, XS6, XT1	30 (M30 x 1.5)	<b>XSZB130</b>	0.020	
		32 (plain)	<b>XUZB32</b>	0.050	
	<b>Set of 2 metal fixing nuts, nickel plated</b>	XS1	5 (M5 x 0.5)	<b>XSZE105</b>	0.010
			8 (M8 x 1)	<b>XSZE108</b>	0.015
		XS1, XS2, XS5, XS6	12 (M12 x 1)	<b>XSZE112</b>	0.015
			18 (M18 x 1)	<b>XSZE118</b>	0.020
30 (M30 x 1.5)		<b>XSZE130</b>	0.050		
<b>Set of 2 stainless steel fixing nuts</b>	XS1, XS2, XS5, XS6	8 (M8 x 1)	<b>XSZE308</b>	0.015	
		12 (M12 x 1)	<b>XSZE312</b>	0.015	
	XS1, XS2, XT1, XS5, XS6	18 (M18 x 1)	<b>XSZE318</b>	0.020	
		30 (M30 x 1.5)	<b>XSZE330</b>	0.050	
	<b>Set of 2 plastic fixing nuts</b>	XS4	8 (M8 x 1)	<b>XSZE208</b>	0.002
12 (M12 x 1)			<b>XSZE212</b>	0.003	
XS4		18 (M18 x 1)	<b>XSZE218</b>	0.004	
<b>Adaptor collar</b>	∅ 20 XS●, XT●	18 (M18 x 1)	<b>XSZA020</b>	0.005	
		30 (M30 x 1.5)	<b>XSZA034</b>	0.005	
	∅ 34 XS●, XT●				

### Protection accessories

<b>Cable sleeve adaptor</b> (CNOMO type)	XS●, XT●	12 (M12 x 1)	<b>XSZP112</b>	0.005
		18 (M18 x 1)	<b>XSZP118</b>	0.005
		30 (M30 x 1.5)	<b>XSZP130</b>	0.010
<b>Outer cover (IP 68)</b>	XT7, XS7, XS8 and XS9 – (C format)	–	<b>XSCZ01</b>	0.100
<b>Thread adaptor</b>	XS●, XT●	30 (M30 x 1.5)	<b>XTAZ30</b>	0.035
<b>13P cable gland</b>	Clamping capacity ∅ 9 to 12 mm		<b>XSZPE13</b>	0.010
<b>Protective cover</b>	M12 universal connectors		<b>XSZF10</b>	0.020

Sold in lots of 50

### Fixings

<b>Threaded inserts for rear fixing</b>	XS●E	M3	<b>XSZVF03</b>	0.002
	XS●C	M4	<b>XSZVF04</b>	0.005
	XS●D	M5	<b>XSZVF05</b>	0.006

### Fuses (for unprotected 2-wire ~ sensors)

Description	Type	Sold in lots of	Unit reference	Weight kg
<b>Cartridge fuses</b> 5 x 20	0.4 A "quick-blow"	10	<b>XUZE04</b>	0.001
	0.63 A "quick-blow"	10	<b>XUZE06</b>	0.001
	0.8 A "quick-blow"	10	<b>XUZE08</b>	0.001
<b>Fuse terminal block for XUZE0●</b>		50	<b>AB1FU10135U</b>	0.040

(1) Depth adjustment shim for converting 80 x 80 x 26 mm format to 80 x 80 x 40 mm format. Also enables clipping onto 35 mm omega rail.

#### XSZBJ00

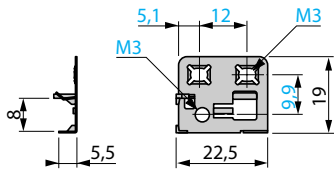

#### XSZBF00

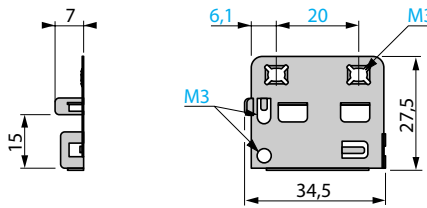

#### XSZBE00

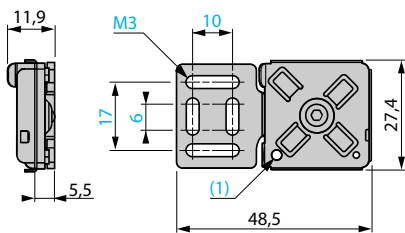

#### XSZBC00

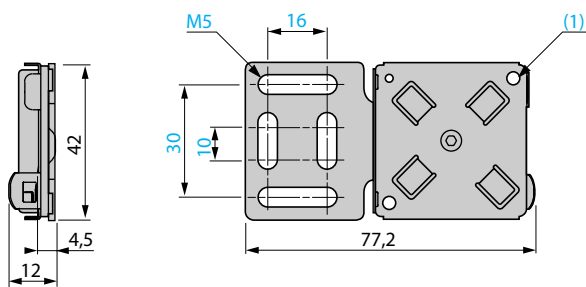

(1) 2 screws M3 x 12 (included).

(1) 4 screws M4 x 14 (included).

#### XSZBJ90

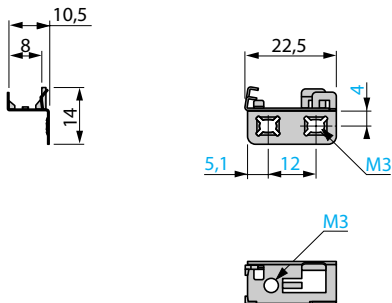

#### XSZBF90

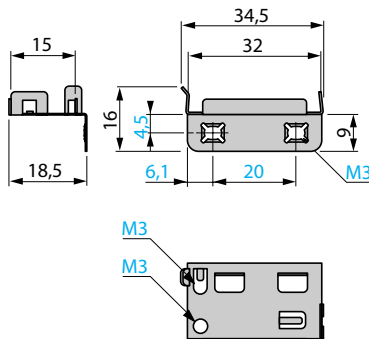

#### XSZBE90

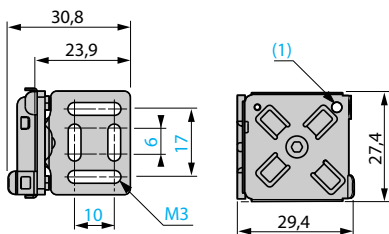

#### XSZBC90

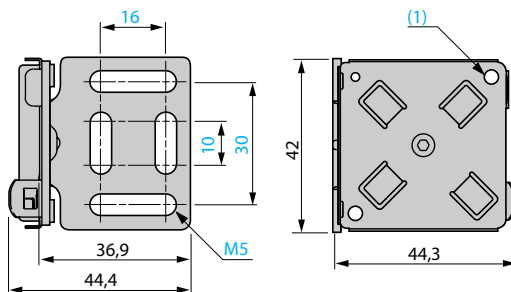

(1) 2 screws M3 x 12 (included).

(1) 4 screws M4 x 14 (included).



**XSZBE10**

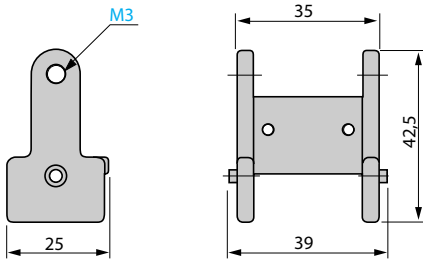

**XSZBC10**

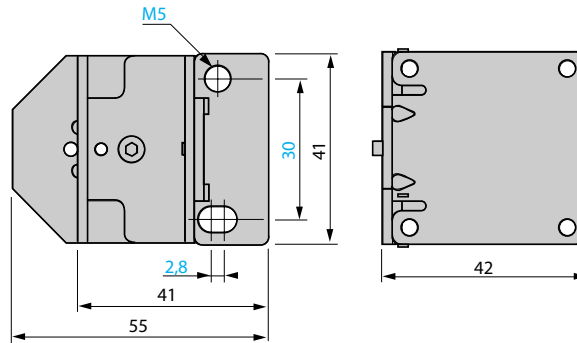

**XSZBD10 (for mounting on XS•D•••••)**

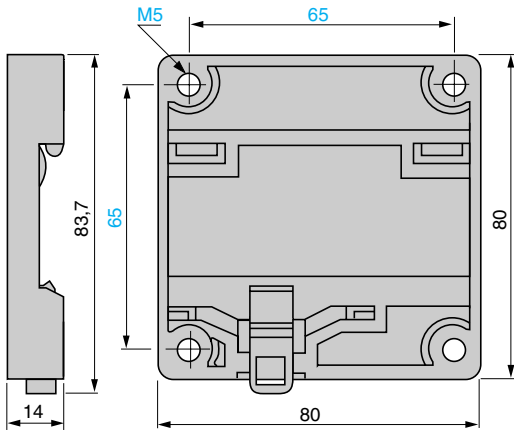

**XSZBPM12**

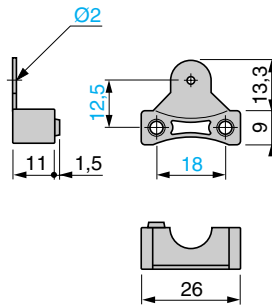

**XSZB104, B105**

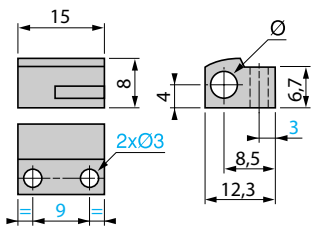

**XSZB108, B112, B118, B130, B165**

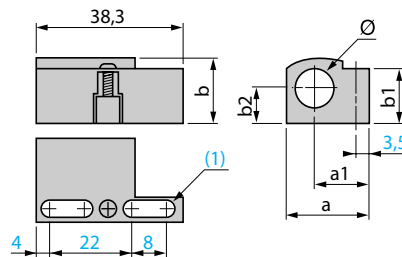

XSZ	a	a1	b	b1	b2	Ø
B108	19.9	14.5	14	12.5	7.5	8
B112	21.9	14.5	16	15.5	8.5	12
B118	26	15.7	22.3	20.1	11.5	18
B130	39	21.7	35.5	31	18.5	30
B165	19.9	14.5	14	12.5	7.5	6.5

(1) 2 elongated holes 4 x 8 mm.

XSZ	Ø
B104	4
B105	5

Note: for fixing clamps XSZB118 and XSZB130, see mounting precautions, page 19.

#### XUZB32

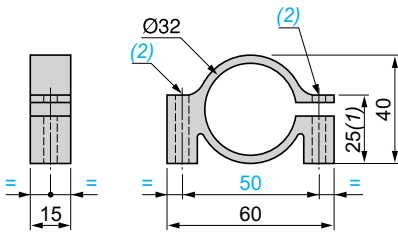

(1) Maximum value

(2) 2 holes  $\varnothing 5.5$

2 x M5 screws, HM head, included with fixing clamp

#### XSZA0●●

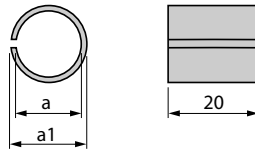

XSZ	a	a1
A020	$\varnothing 18$	$\varnothing 20$
A034	$\varnothing 30$	$\varnothing 34$

#### XSZP112, P118, P130

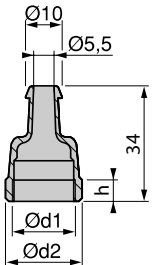

XSZ	h	$\varnothing d1$	$\varnothing d2$
P112	7	12	16,8
P118	6,2	18	23
P130	6,2	30	34,4

#### XSCZ01

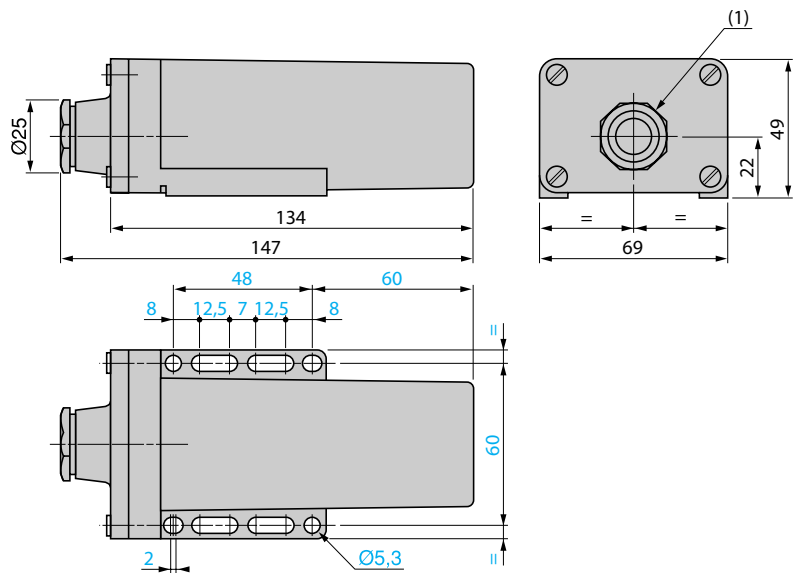

#### XTAZ30

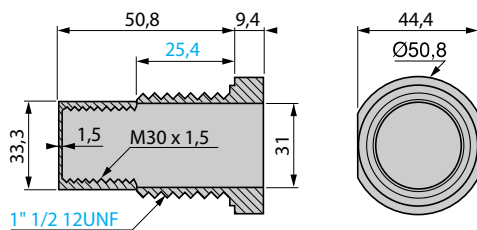

(1) 13P cable gland

## Cylindrical type sensors

### Flush mountable in metal

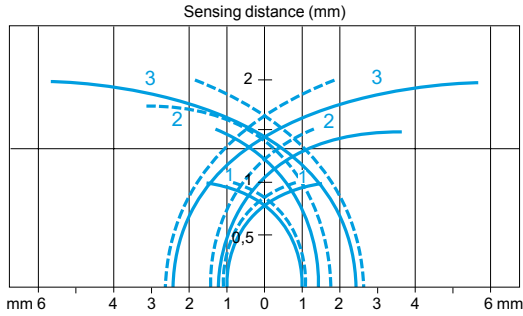

Sensor (mm)	Standard steel target (mm)	Operating zone (mm)
Ø 4	5 x 5 x 1	0...0.8
Ø 5	5 x 5 x 1	0...0.8
Ø 6.5	8 x 8 x 1	0...1.2
Ø 8	8 x 8 x 1	0...1.2
Ø 12	12 x 12 x 1	0...1.6

— pick-up points  
 - - - drop-out points (object approaching from the side)  
 1 Ø 4 (plain) XS1 and Ø 5 (M5 x 0.5) XS1  
 2 Ø 6.5 (plain) XS1 and Ø 8 (M8 x 1) XS5  
 3 Ø 12 (M12 x 1) XS5

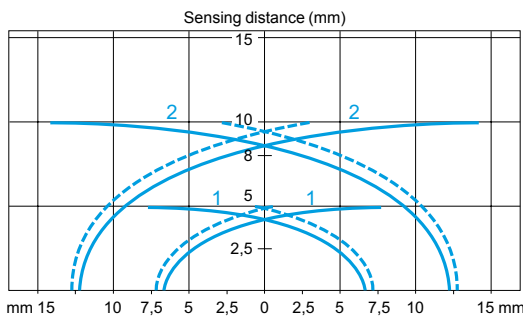

Sensor (mm)	Standard steel target (mm)	Operating zone (mm)
Ø 18	18 x 18 x 1	0...4
Ø 30	30 x 30 x 1	0...8

— pick-up points  
 - - - drop-out points (object approaching from the side)  
 1 Ø 18 (M18 x 1) XS5  
 2 Ø 30 (M30 x 1.5) XS5

### Non flush mountable in metal

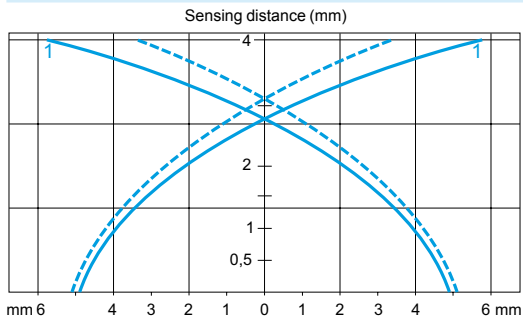

Sensor (mm)	Standard steel target (mm)	Operating zone (mm)
Ø 12	12 x 12 x 1	0...3.2

— pick-up points  
 - - - drop-out points (object approaching from the side)  
 1 Ø 12 (M12 x 1) XS4

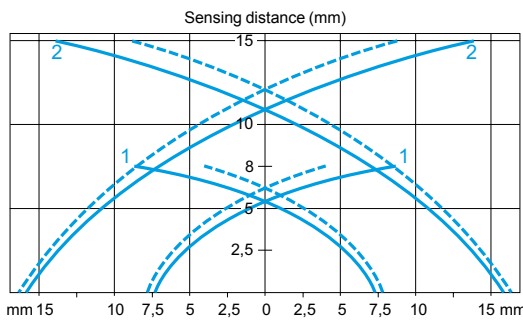

Sensor (mm)	Standard steel target (mm)	Operating zone (mm)
Ø 18	24 x 24 x 1	0...6.4
Ø 30	45 x 45 x 1	0...12

— pick-up points  
 - - - drop-out points (object approaching from the side)  
 1 Ø 18 (M18 x 1) XS4  
 2 Ø 30 (M30 x 1.5) XS4

### Cylindrical type sensors, increased range

#### Flush mountable in metal

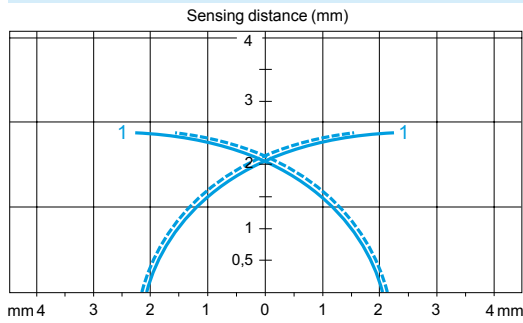

Sensor (mm)	Standard steel target (mm)	Operating zone (mm)
Ø 6.5	8 x 8 x 1	0...2
Ø 8	8 x 8 x 1	0...2

— pick-up points  
 - - - drop-out points (object approaching from the side)  
 1 Ø 6.5 (plain) XS106B3●● and Ø 8 (M8 x 1) XS108B3 and XS608●●

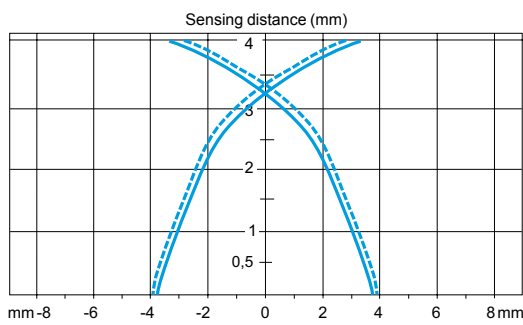

Sensor (mm)	Standard steel target (mm)	Operating zone (mm)
Ø 12	12 x 12 x 1	0...3.2

— pick-up points  
 - - - drop-out points (object approaching from the side)

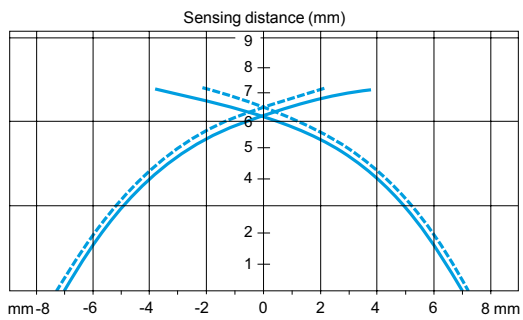

Sensor (mm)	Standard steel target (mm)	Operating zone (mm)
Ø 18	24 x 24 x 1	0...6.4

— pick-up points  
 - - - drop-out points (object approaching from the side)

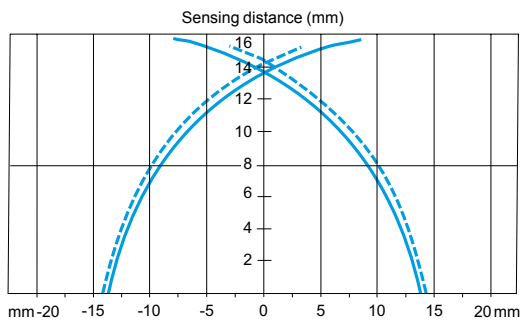

Sensor (mm)	Standard steel target (mm)	Operating zone (mm)
Ø 30	45 x 45 x 1	0...12

— pick-up points  
 - - - drop-out points (object approaching from the side)

### Cubic, flat or rectangular type sensors

#### Flush mountable in metal

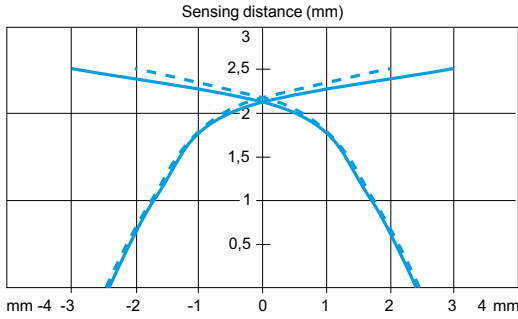

Sensor	Standard steel target (mm)	Operating zone (mm)
<b>XS7J1A1</b>	5 x 5 x 1	0...2
— pick-up points - - - drop-out points (object approaching from the side)		

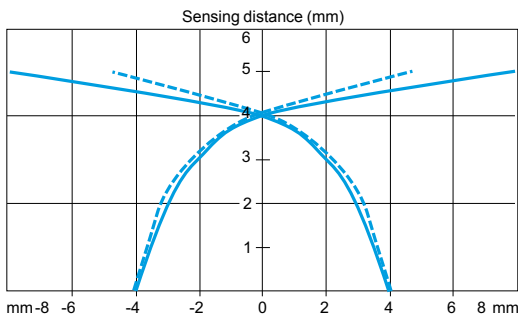

Sensor	Standard steel target (mm)	Operating zone (mm)
<b>XS7F1A1</b>	5 x 5 x 1	0...4
— pick-up points - - - drop-out points (object approaching from the side)		

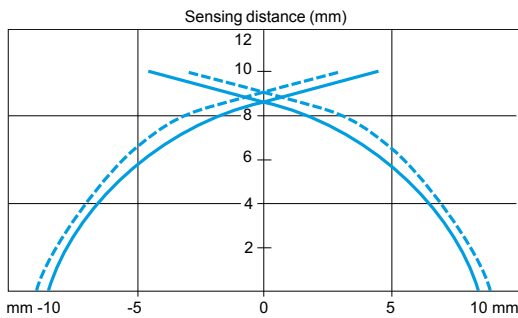

Sensor	Standard steel target (mm)	Operating zone (mm)
<b>XS7E1A1</b>	8 x 8 x 1	0...8
— pick-up points - - - drop-out points (object approaching from the side)		

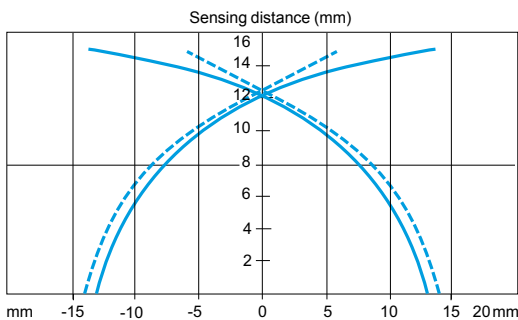

Sensor	Standard steel target (mm)	Operating zone (mm)
<b>XS7C1A1</b> <b>XS7C2A1</b> <b>XS7C4A1</b>	18 x 18 x 1	0...12
— pick-up points - - - drop-out points (object approaching from the side)		

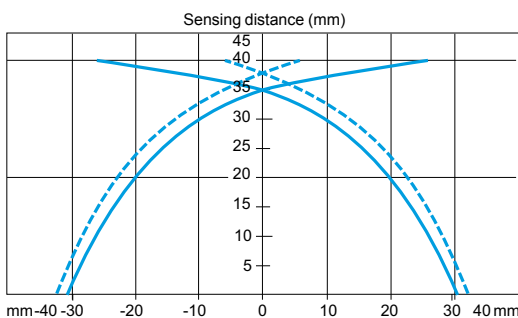

Sensor	Standard steel target (mm)	Operating zone (mm)
<b>XS7D1A1</b>	30 x 30 x 1	0...32
— pick-up points - - - drop-out points (object approaching from the side)		

### Cubic or rectangular type sensors, increased range

#### Flush mountable in metal

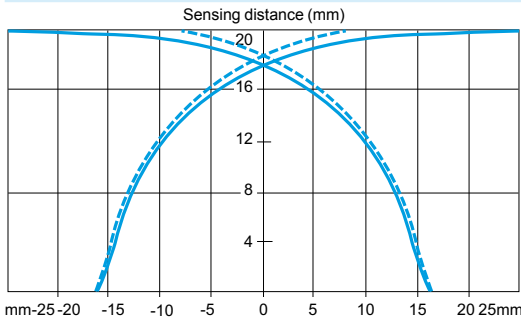

Sensor	Standard steel target (mm)	Operating zone (mm)
<b>XS8C●A1●</b>	30 x 30 x 1	0...16
— pick-up points - - - drop-out points (object approaching from the side)		

#### Non flush mountable in metal

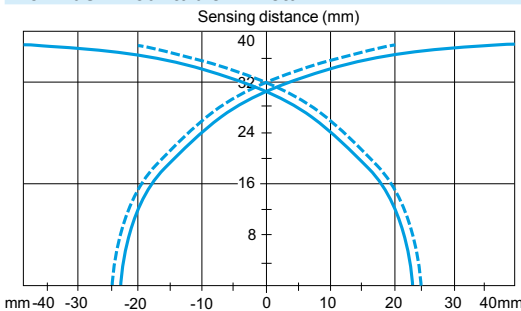

Sensor	Standard steel target (mm)	Operating zone (mm)
<b>XS8C●A4●</b>	45 x 45 x 1	0...32
— pick-up points - - - drop-out points (object approaching from the side)		

### Flat type sensors, increased range

#### Flush mountable in metal

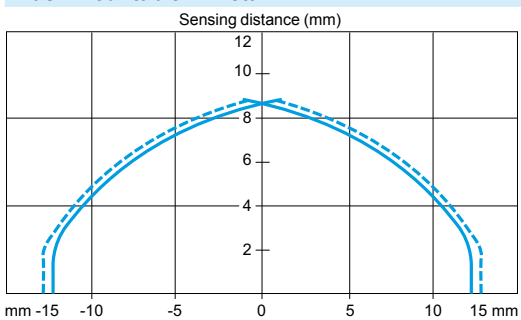

#### Non flush mountable in metal

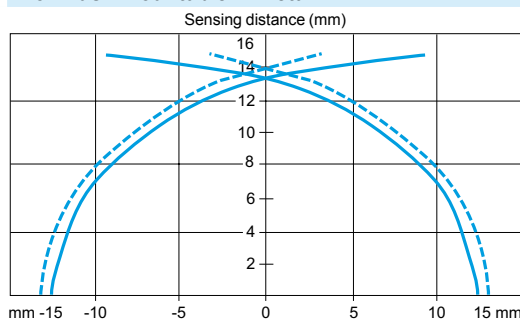

Sensor
<b>XS8E</b>
<b>Standard steel target (mm)</b>
18 x 18 x 1
<b>Operating zone (mm)</b>
5...15 (not flush mounted) 5...10 (flush mounted)

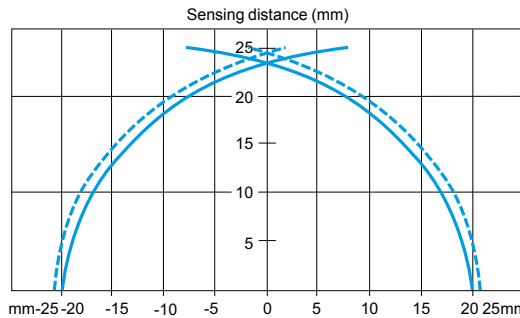
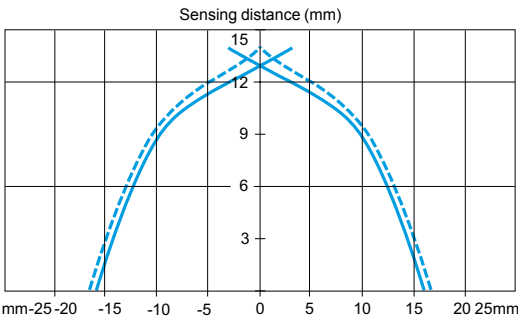

Sensor
<b>XS8C</b>
<b>Standard steel target (mm)</b>
30 x 30 x 1
<b>Operating zone (mm)</b>
8...25 (not flush mounted) 8...15 (flush mounted)

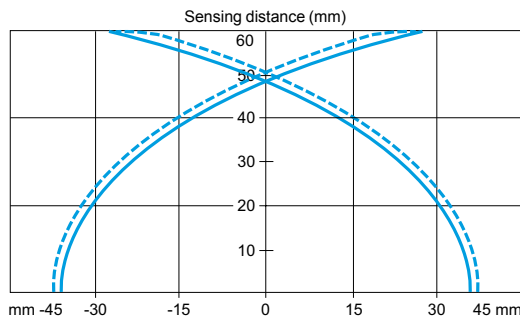
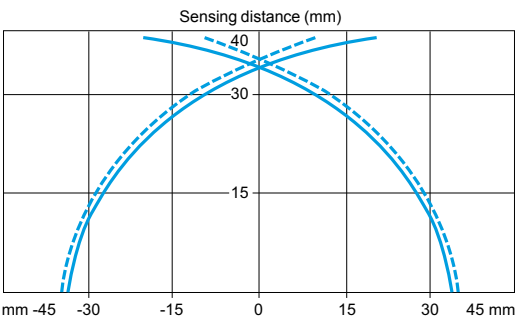

Sensor
<b>XS8D</b>
<b>Standard steel target (mm)</b>
45 x 45 x 1
<b>Operating zone (mm)</b>
20...60 (not flush mounted) 20...40 (flush mounted)

— pick-up points  
 - - - drop-out points (object approaching from the side)









# Substitution table

Sensors with the closest functionalities

# Inductive proximity sensors

Old sensor	New OsiSense XS sensor	Old sensor	New OsiSense XS sensor	Old sensor	New OsiSense XS sensor
<b>Cylindrical type, DC (continued)</b>					
<b>Diameter 30 mm</b>					
<b>XS1</b>					
XS1D30NA140	XS130BLNAL2	XS1M30PA370D	XS530BLPAM12	XS2M30NB370L2	XS630B1NBL10
XS1D30NA140D	XS130BLNAM12	XS1M30PA370G	XS630B1PAL01G (4)	XS2M30PA370	XS630B1PAL2
XS1D30PA140	XS130BLPAL2	XS1M30PA370L1	XS530BLPAL5	XS2M30PA370A	XS630B1PAL01U78 (4)
XS1D30PA140D	XS130BLPAM12	XS1M30PA370L2	XS530BLPAL10	XS2M30PA370B	XS630B1PAL01B (4)
XS1D30PA140L1	XS130BLPAL5	XS1M30PB370	XS530BLPBL2	XS2M30PA370C	XS630B1PAL01C (4)
XS2D30NA140	XS230BLNAL2	XS1M30PB370B	XS630B1PBL01B (4)	XS2M30PA370D	XS630B1PAM12
XS2D30NA140D	XS230BLNAM12	XS1M30PB370C	XS630B1PBL01C (4)	XS2M30PA370G	XS630B1PAL01G (4)
XS2D30PA140	XS230BLPAL2	XS1M30PB370D	XS530BLPBM12	XS2M30PA370L1	XS630B1PAL5
XS2D30PA140D	XS230BLPAM12	XS1M30PB370G	XS630B1PBL01G (4)	XS2M30PA370L2	XS630B1PAL10
		XS1M30PB370L1	XS530BLPBL5	XS2M30PB370	XS630B1PBL2
		XS1M30PB370L2	XS530BLPBL10	XS2M30PB370B	XS630B1PBL01B (4)
				XS2M30PB370C	XS630B1PBL01C (4)
				XS2M30PB370D	XS630B1PBM12
		XS1N30NA340	XS530B1NAL2	XS2M30PB370G	XS630B1PBL01G (4)
XS1M30DA210	XS530B1DAL2	XS1N30NA340D	XS530B1NAM12	XS2M30PB370L1	XS630B1PBL5
XS1M30DA210B	XS530B1DAL01B (4)	XS1N30NA340L1	XS530B1NAL5	XS2M30PB370L2	XS630B1PBL10
XS1M30DA210C	XS530B1DAL01C (4)	XS1N30NA340L2	XS530B1NAL10		
XS1M30DA210D	XS530B1DAM12	XS1N30NB340	XS530B1NBL2	<b>XS3</b>	
XS1M30DA210G	XS530B1DAL01G (4)	XS1N30NB340D	XS530B1NBM12	XS3P30NA340	XS530B1NAL2 (3)
XS1M30DA210L1	XS530B1DAL5	XS1N30PA340	XS530B1PAL2	XS3P30NA340D	XS530B1NAM12 (3)
XS1M30DA210L2	XS530B1DAL10	XS1N30PA340D	XS530B1PAM12	XS3P30NA340L1	XS530B1NAL5 (3)
XS1M30DA210LD	XS530B1DAL08M12	XS1N30PA340L1	XS530B1PAL5	XS3P30PA340	XS530B1PAL2 (3)
XS1M30DB210	XS530B1DBL2	XS1N30PA340L2	XS530B1PAL10	XS3P30PA340D	XS530B1PAM12 (3)
XS1M30DB210B	XS530B1DBL01B (4)	XS1N30PB340	XS530B1PBL2	XS3P30PA340L1	XS530B1PAL5 (3)
XS1M30DB210D	XS530B1DBM12	XS1N30PB340D	XS530B1PBM12	XS3P30PA340L2	XS530B1PAL10 (3)
XS1M30DB210LD	XS530B1DBM12 (1)				
		<b>XS2</b>			
XS1M30DA214D	XS530B1CAM12	XS2N30NA340	XS130B3NAL2	XS3P30PA370	XS530BLPAL2 (3)
XS1M30DA214LD	XS530B1CAL08M12	XS2N30NA340D	XS130B3NAM12	XS3P30PA370L1	XS530BLPAL5 (3)
		XS2N30NA340L1	XS130B3NAL5	XS3P30PA370L2	XS530BLPAL10 (3)
		XS2N30NA340L2	XS130B3NAL10	XS3P30NA370	XS530BLNAL2 (3)
XS1M30PA349D	XS630B1PAM12 (5)	XS2N30NB340	XS130B3NBL2	XS3P30NA370L1	XS530BLNAL5 (3)
		XS2N30NB340D	XS130B3NBM12		
		XS2N30PA340	XS130B3PAL2	<b>XS4</b>	
XS1M30NA370	XS530BLNAL2	XS2N30PA340D	XS130B3PAM12	XS4P30NA370B	XS4P30NA370L01B (4)
XS1M30NA370B	XS630B1NAL01B (4)	XS2N30PA340L1	XS130B3PAL5	XS4P30NB370B	XS4P30NB370L01B (4)
XS1M30NA370C	XS630B1NAL01C (4)	XS2N30PA340L2	XS130B3PAL10	XS4P30PA370B	XS4P30PA370L01B (4)
XS1M30NA370D	XS530BLNAM12	XS2N30PB340	XS130B3PBL2	XS4P30PB370B	XS4P30PB370L01B (4)
XS1M30NA370L1	XS530BLNAL5	XS2N30PB340D	XS130B3PBM12		
XS1M30NA370L2	XS530BLNAL10				
XS1M30NB370	XS530BLNBL2	XS2M30NA370	XS630B1NAL2		
XS1M30NB370B	XS630B1NBL01B (4)	XS2M30NA370B	XS630B1NAL01B (4)		
XS1M30NB370C	XS630B1NBL01C (4)	XS2M30NA370C	XS630B1NAL01C (4)		
XS1M30NB370D	XS530BLNBM12	XS2M30NA370D	XS630B1NAM12		
XS1M30NB370L1	XS530BLNBL5	XS2M30NA370L1	XS630B1NAL5		
XS1M30NB370L2	XS530BLNBL10	XS2M30NA370L2	XS630B1NAL10		
		XS2M30NB370	XS630B1NBL2		
XS1M30PA370	XS530BLPAL2	XS2M30NB370B	XS630B1NBL01B (4)		
XS1M30PA370A	XS630B1PAL01U78 (4)	XS2M30NB370C	XS630B1NBL01C (4)		
XS1M30PA370B	XS630B1PAL01B (4)	XS2M30NB370D	XS630B1NBM12		
XS1M30PA370C	XS630B1PAL01C (4)	XS2M30NB370L1	XS630B1NBL5		

(1) For the new sensor an integral M12 connector replaces the remote M12 connector on a 0.80 m flying lead.

(3) For the new OsiSense XS sensor, the metal case replaces the plastic case.

(4) For the new sensor, connectors A, B, C and G on 0.1 m flying lead replace integral connectors A, B, C and G.

(5) For the new sensor, Sn = 15 mm instead of 20 mm.

# Substitution table

Sensors with the closest functionalities

# Inductive proximity sensors

Old sensor	New OsiSense XS sensor	Old sensor	New OsiSense XS sensor	Old sensor	New OsiSense XS sensor
<b>Cylindrical type, AC or DC</b>		<b>Diameter 18 mm</b>		<b>XS3</b>	
<b>Diameter 12 mm</b>		<b>XS1</b>		<b>XS3</b>	
<b>XS1</b>		<b>XS1</b>		<b>XS3P18MA230</b>	
XS1M12FA264	XS112BLFAL2	XS1M18FA264	XS118BLFAL2	XS3P18MA230K	XS618B1MAU20 (3)
XS1M12FA264L2	XS112BLFAL10			XS3P18MA230L1	XS618B1MAL5 (3)
		XS1M18MA230	XS518B1MAL2	XS3P18MA230L2	XS618B1MAL10 (3)
XS1M12MA230	XS512B1MAL2	XS1M18MA230A	XS618B1MAL01U78 (4)	XS3P18MB230	XS618B1MBL2 (3)
XS1M12MA230K	XS512B1MAU20	XS1M18MA230B	XS618B1MAL01B (4)	XS3P18MB230A	XS618B1MBU20 (3)
XS1M12MA230L1	XS512B1MAL5	XS1M18MA230C	XS618B1MAL01C (4)	XS3P18MB230K	XS618B1MBU20 (3)
XS1M12MA230L2	XS512B1MAL10	XS1M18MA230G	XS618B1MAL01G (4)	XS3P18MB230L1	XS618B1MBL5 (3)
XS1M12MB230	XS512B1MBL2	XS1M18MA230K	XS518B1MAU20		
XS1M12MB230K	XS512B1MBU20	XS1M18MA230L1	XS518B1MAL5	<b>XS4</b>	
XS1M12MB230L1	XS512B1MBL5	XS1M18MA230L2	XS518B1MAL10	XS4P18MA230B	XS4P18MA230L01B (4)
XS1M12MB230L2	XS512B1MBL10	XS1M18MB230	XS518B1MBL2	XS4P18MA230C	XS4P18MA230L01C (4)
		XS1M18MB230A	XS618B1MBL01U78 (4)	XS4P18MA230G	XS4P18MA230L01G (4)
XS1M12MA239	XS612B1MAL2	XS1M18MB230B	XS618B1MBL01B (4)	XS4P18MB230B	XS4P18MB230L01B (4)
XS1M12MA239K	XS612B1MAU20	XS1M18MB230C	XS618B1MBL01C (4)	XS4P18MB230C	XS4P18MB230L01C (4)
		XS1M18MB230G	XS618B1MBL01G (4)		
		XS1M18MB230K	XS518B1MBU20		
		XS1M18MB230L1	XS518B1MBL5		
		XS1M18MB230L2	XS518B1MBL10		
<b>XS2</b>					
XS2M12MA230	XS612B1MAL2	XS1M18MA239	XS618B1MAL2 (5)		
XS2M12MA230K	XS612B1MAU20	XS1M18MA239A	XS1M18MA239L01A (4)		
XS2M12MA230L1	XS612B1MAL5	XS1M18MA239K	XS618B1MAU20 (5)		
XS2M12MA230L2	XS612B1MAL10				
XS2M12MB230	XS612B1MBL2	<b>XS2</b>			
XS2M12MB230K	XS612B1MBU20	XS2M18MA230	XS618B1MAL2		
XS2M12MB230L1	XS612B1MBL5	XS2M18MA230A	XS618B1MAL01U78 (4)		
XS2M12MB230L2	XS612B1MBL10	XS2M18MA230B	XS618B1MAL01B (4)		
		XS2M18MA230C	XS618B1MAL01C (4)		
<b>XS3</b>		XS2M18MA230G	XS618B1MAL01G (4)		
XS3P12MA230	XS612B1MAL2 (3)	XS2M18MA230K	XS618B1MAU20		
XS3P12MA230K	XS612B1MAU20 (3)	XS2M18MA230L1	XS618B1MAL5		
XS3P12MA230L1	XS612B1MAL5 (3)	XS2M18MA230L2	XS618B1MAL10		
XS3P12MA230L2	XS612B1MAL10 (3)	XS2M18MB230	XS618B1MBL2		
XS3P12MB230	XS612B1MBL2 (3)	XS2M18MB230A	XS618B1MBL01U78 (4)		
XS3P12MB230K	XS612B1MBU20 (3)	XS2M18MB230B	XS618B1MBL01B (4)		
XS3P12MB230L1	XS612B1MBL5 (3)	XS2M18MB230C	XS618B1MBL01C (4)		
		XS2M18MB230G	XS618B1MBL01G (4)		
		XS2M18MB230K	XS618B1MBU20		
		XS2M18MB230L1	XS618B1MBL5		
		XS2M18MB230L2	XS618B1MBL10		

(3) For the new OsiSense XS sensor, the metal case replaces the plastic case.

(4) For the new sensor, connectors A, B, C and G on 0.1 m flying lead replace integral connectors A, B, C and G.

(5) For the new sensor, Sn = 8 mm instead of 10 mm.



# Technical information

## Protective treatment of equipment according to climatic environment

Depending on the climatic and environmental conditions in which the equipment is placed, Telemecanique Sensors can offer specially adapted products to meet your requirements.

In order to make the correct choice of protective finish, two points should be remembered:

- the prevailing climate of the country is never the only criterion,
- only the atmosphere in the immediate vicinity of the equipment need be considered.

### All climates treatment “TC”

This is the standard treatment for Telemecanique Sensors brand equipment and is suitable for the vast majority of applications. It is the equivalent of treatments described as “Klimafest”, “Climateproof”.

In particular, it meets the requirements specified in the following publications:

- Publication UTE C 63-100 (method I), successive cycles of humid heat at: + 40 °C and 95 % relative humidity.
- DIN 50016 - Variations of ambient conditions within a climatic chamber: + 23 °C and 83 % relative humidity, + 40 °C and 92 % relative humidity.

It also meets the requirements of the following marine classification societies: BV-LR-GL-DNV-RINA.

### Characteristics

- Steel components are usually treated with zinc. When they have a mechanical function, they may also be painted.
- Insulating materials are selected for their high electrical, dielectric and mechanical characteristics.
- Metal enclosures have a stoved paint finish, applied over a primary phosphate protective coat, or are galvanised (e.g. some prefabricated busbar trunking components).

### Limits for use of “TC” (All climates) treatment

- “TC” treatment is suitable for the following temperatures and humidity:

Temperature (°C)	Relative humidity (%)
20	95
40	80
50	50

“TC” treatment is therefore suitable for all latitudes and in particular tropical and equatorial regions where the equipment is mounted in normally ventilated industrial premises. Being sheltered from external climatic conditions, temperature variations are small, the risk of condensation is minimised and the risk of dripping water is virtually non-existent.

### Extension of use of “TC” (All climates) treatment

In cases where the humidity around the equipment exceeds the conditions described above, or in equatorial regions if the equipment is mounted outdoors, or if it is placed in a very humid location (laundries, sugar refineries, steam rooms, etc.), “TC” treatment can still be used if the following precautions are taken:

- The enclosure in which the equipment is mounted must be protected with a “TH” finish (see next page) and must be well ventilated to avoid condensation and dripping water (e.g. enclosure base plate mounted on spacers).
- Components mounted inside the enclosure must have a “TC” finish.
- If the equipment is to be switched off for long periods, a heater must be provided (0.2 to 0.5 kW per square decimetre of enclosure), that switches on automatically when the equipment is turned off. This heater keeps the inside of the enclosure at a temperature slightly higher than the outside surrounding temperature, thereby avoiding any risk of condensation and dripping water (the heat produced by the equipment itself during normal running is sufficient to provide this temperature difference).
- Special considerations for “Operator dialog” and “Detection” products: for certain pilot devices, the use of “TC” treatment can be extended to outdoor use provided their enclosure is made of light alloys, zinc alloys or plastic material. In this case, it is also essential to ensure that the degree of protection against penetration of liquids and solid objects is suitable for the applications involved.



# Technical information

## Protective treatment of equipment according to climatic environment

### “TH” treatment for hot and humid environments

This treatment is suitable for hot and humid atmospheres where installations are regularly subject to condensation, dripping water and the risk of fungi.

In addition, plastic insulating components are resistant to attacks from insects such as termites and cockroaches. These properties have often led to this treatment being described as “Tropical Finish”, but this does not mean that all equipment installed in tropical and equatorial regions must systematically have undergone “TH” treatment. On the other hand, certain operating conditions in temperate climates may well require the use of “TH” treated equipment (see limitations for use of “TC” treatment).

### Special characteristics of “TH” treatment

- All insulating components are made of materials which are either resistant to fungi or treated with a fungicide, and which have increased resistance to creepage (Standards IEC 60112, NF C 26-220, DIN 5348).
- Metal enclosures receive a top-coat of stoved, fungicidal paint, applied over a rust inhibiting undercoat. Components with “TH” treatment may be subject to a surcharge (1). Please consult your Customer Care Centre.

### Protective treatment selection guide

Surrounding environment	Duty cycle	Internal heating of enclosure when not in use	Type of climate	Protective treatment	
				of equipment	of enclosure
<b>Indoors</b>					
No dripping water or condensation	Unimportant	Not necessary	Unimportant	“TC”	“TC”
Presence of dripping water or condensation	Frequent switching off for periods of more than 1 day	No	Temperate	“TC”	“TH”
		Yes	Equatorial	“TH”	“TH”
	Continuous	Not necessary	Unimportant	“TC”	“TH”
<b>Outdoors (sheltered)</b>					
No dripping water or dew	Unimportant	Not necessary	Temperate	“TC”	“TC”
			Equatorial	“TH”	“TH”
<b>Exposed outdoors or near the sea</b>					
Frequent and regular presence of dripping water or dew	Frequent switching off for periods of more than 1 day	No	Temperate	“TC”	“TH”
		Yes	Equatorial	“TH”	“TH”
	Continuous	Not necessary	Unimportant	“TC”	“TH”

These treatments cover, in particular, the applications defined by methods I and II of guide UTE C 63-100.

### Special precautions for electronic equipment

Electronic products always meet the requirements of “TC” treatment. A number of them are “TH” treated as standard.

Some electronic products (for example: programmable controllers, flush mountable controllers CCX and flush mountable operator terminals XBT) require the use of an enclosure providing a degree of protection to at least IP 54, as defined by standards IEC 60664 and NF C 20 040, for use in industrial applications or in environmental conditions requiring “TH” treatment.

These electronic products, including flush mountable products, must have a degree of protection to at least IP 20 (provided either by their own enclosure or by their installation method) for restricted access locations where the degree of pollution does not exceed 2 (a test booth not containing machinery or other dust producing activities, for example).

### Special treatments

For particularly harsh industrial environments, Telemecanique Sensors is able to offer special protective treatments. Please consult your Customer Care Centre.

(1) A large number of the Telemecanique Sensors brand products are “TH” treated as standard and are, therefore, not subject to a surcharge.

# Technical information

## Product standards and certifications

### Standardisation

#### Conformity to standards

Telemecanique Sensors products satisfy, in the majority of cases, national (for example: BS in Great Britain, NF in France, DIN in Germany), European (for example: CENELEC) or international (IEC) standards. These product standards precisely define the performance of the designated products (such as IEC 60947 for low voltage equipment).

When used correctly, as designated by the manufacturer and in accordance with regulations and correct practices, these products will allow users to build equipment, machine systems or installations that conform to their appropriate standards (for example: IEC 60204-1, relating to electrical equipment used on industrial machines).

Telemecanique Sensors is able to provide proof of conformity of its production to the standards it has chosen to comply with, through its quality assurance system.

On request, and depending on the situation, Telemecanique Sensors can provide the following:

- a declaration of conformity,
- a certificate of conformity (ASEFA/LOVAG),
- a homologation certificate or approval, in the countries where this procedure is required or for particular specifications, such as those existing in the merchant navy.

Code	Certification authority		Country
	Name	Abbreviation	
ANSI	American National Standards Institute	ANSI	USA
BS	British Standards Institution	BSI	Great Britain
CEI	Comitato Elettrotecnico Italiano	CEI	Italy
DIN/VDE	Verband Deutscher Electrotechniker	VDE	Germany
EN	Comité Européen de Normalisation Electrotechnique	CENELEC	Europe
GOST	Gosudarstvennoe Komitet Standartov	GOST	Russia
IEC	International Electrotechnical Commission	IEC	Worldwide
JIS	Japanese Industrial Standards Committee	JISC	Japan
NBN	Institut Belge de Normalisation	IBN	Belgium
NEN	Nederlands Normalisatie Instituut	NNI	Netherlands
NF	Union Technique de l'Electricité	UTE	France
SAA	Standards Association of Australia	SAA	Australia
UNE	Asociacion Española de Normalizacion y Certificacion	AENOR	Spain

#### European EN standards

These are technical specifications established in conjunction with, and with approval of, the relative bodies within the various CENELEC member countries (European Union, European Free Trade Association and many central and eastern European countries having «member» or «affiliated» status). Prepared in accordance with the principle of consensus, the European standards are the result of a weighted majority vote. Such adopted standards are then integrated into the national collection of standards, and contradictory national standards are withdrawn.

European standards incorporated within the French collection of standards carry the prefix NF EN. At the 'Union Technique de l'Electricité' (*Technical Union of Electricity*) (UTE), the French version of a corresponding European standard carries a dual number: European reference (NF EN ...) and classification index (C ...).

Therefore, the standard NF EN 60947-4-1 relating to motor contactors and starters, effectively constitutes the French version of the European standard EN 60947-4-1 and carries the UTE classification C 63-110.

This standard is identical to the British standard BS EN 60947-4-1 or the German standard DIN EN 60947-4-1.

Whenever reasonably practical, European standards reflect the international standards (IEC).

With regard to automation system components and distribution equipment, in addition to complying with the requirements of French NF standards, Telemecanique Sensors brand components conform to the standards of all other major industrial countries.

### Regulations

#### European Directives

Opening up of European markets assumes harmonisation of the regulations pertaining to each of the member countries of the European Union.

The purpose of the European Directive is to eliminate obstacles hindering the free circulation of goods within the European Union, and it must be applied in all member countries. Member countries are obliged to transcribe each Directive into their national legislation and to simultaneously withdraw any contradictory regulations. The Directives, in particular those of a technical nature which concern us, only establish the objectives to be achieved, referred to as "essential requirements".

The manufacturer must take all the necessary measures to ensure that his products conform to the requirements of each Directive applicable to his production.

As a general rule, the manufacturer certifies conformity to the essential requirements of the Directive(s) for his product by affixing the CE mark.

The CE mark is affixed to Telemecanique Sensors brand products concerned, in order to comply with French and European regulations.

#### Significance of the CE mark

- The CE mark affixed to a product signifies that the manufacturer certifies that the product conforms to the relevant European Directive(s) which concern it; this condition must be met to allow free distribution and circulation within the countries of the European Union of any product subject to one or more of the E.U. Directives.
- The CE mark is intended solely for national market control authorities.
- The CE mark must not be confused with a conformity marking.



# Technical information

## Product standards and certifications

### European Directives (continued)

For electrical equipment, only conformity to standards signifies that the product is suitable for its designated function, and only the guarantee of an established manufacturer can provide a high level of quality assurance.

For Telemecanique Sensors brand products, one or several Directives are likely to be applicable, depending on the product, and in particular:

- the Low Voltage Directive 2006/95/EC: the CE mark relating to this Directive has been compulsory since 16<sup>th</sup> January 2007.
- the Electromagnetic Compatibility Directive 89/336/EEC, amended by Directives 92/31/EEC and 93/68/EEC: the CE mark on products covered by this Directive has been compulsory since 1st January 1996.

### ASEFA-LOVAG certification

The function of ASEFA (Association des Stations d'Essais Française d'Appareils électriques - Association of French Testing Stations for Low Voltage Industrial Electrical Equipment) is to carry out tests of conformity to standards and to issue certificates of conformity and test reports. ASEFA laboratories are authorised by the French authorisation committee (COFRAC). ASEFA is now a member of the European agreement group LOVAG (Low Voltage Agreement Group). This means that any certificates issued by LOVAG/ASEFA are recognised by all the authorities which are members of the group and carry the same validity as those issued by any of the member authorities.

### Quality labels

When components can be used in domestic and similar applications, it is sometimes recommended that a "Quality label" be obtained, which is a form of certification of conformity.

Code	Quality label	Country
CEBEC	Comité Electrotechnique Belge	Belgium
KEMA-KEUR	Keuring van Electrotechnische Materialen	Netherlands
NF	Union Technique de l'Electricité	France
ÖVE	Österreichischer Verband für Electrotechnik	Austria
SEMKO	Svenska Elektriska Materiel Kontrollanatalten	Sweden

### Product certifications

In some countries, the certification of certain electrical components is a legal requirement. In this case, a certificate of conformity to the standard is issued by the official test authority.

Each certified device must bear the relevant certification symbols when these are mandatory:

Code	Certification authority	Country
CSA	Canadian Standards Association	Canada
UL	Underwriters Laboratories	USA
CCC	China Compulsory Certification	China

Note on certifications issued by the Underwriters Laboratories (UL). There are two levels of approval:

**"Recognized" (UL)** The component is fully approved for inclusion in equipment built in a workshop, where the operating limits are known by the equipment manufacturer and where its use within such limits is acceptable by the Underwriters Laboratories.  
The component is not approved as a "Product for general use" because its manufacturing characteristics are incomplete or its application possibilities are limited.  
A "Recognized" component does not necessarily carry the certification symbol.

**"Listed" (UL)** The component conforms to all the requirements of the classification applicable to it and may therefore be used both as a "Product for general use" and as a component in assembled equipment. A "Listed" component must carry the certification symbol.

### Marine classification societies

Prior approval (= certification) by certain marine classification societies is generally required for electrical equipment which is intended for use on board merchant vessels.

Code	Classification authority	Country
BV	Bureau Veritas	France
DNV	Det Norske Veritas	Norway
GL	Germanischer Lloyd	Germany
LR	Lloyd's Register	Great Britain
NKK	Nippon Kaiji Kyokai	Japan
RINA	Registro Italiano Navale	Italy
RRS	Register of Shipping	Russia

### Note

For further details on a specific product, please refer to the "Characteristics" pages in this catalogue or consult your Customer Care Centre.

# Technical information

## Degrees of protection provided by enclosures IP code

### Degrees of protection against the penetration of solid bodies, water and personnel access to live parts

The European standard EN 60529 dated October 1991, IEC publication 529 (2<sup>nd</sup> edition - November 1989), defines a coding system (IP code) for indicating the degree of protection provided by electrical equipment enclosures against accidental direct contact with live parts and against the ingress of solid foreign objects or water. This standard does not apply to protection against the risk of explosion or conditions such as humidity, corrosive gasses, fungi or vermin.

Certain equipment is designed to be mounted on an enclosure which will contribute towards achieving the required degree of protection (example : control devices mounted on an enclosure).

Different parts of an equipment can have different degrees of protection (example : enclosure with an opening in the base).

Standard NF C 15-100 (May 1991 edition), section 512, table 51 A, provides a cross-reference between the various degrees of protection and the environmental conditions classification, relating to the selection of equipment according to external factors.

Practical guide UTE C 15-103 shows, in the form of tables, the characteristics required for electrical equipment (including minimum degrees of protection), according to the locations in which they are installed.

### IP ●●● code

The IP code comprises **2 characteristic numerals** (e.g. **IP 55**) and may include **an additional letter** when the actual protection of personnel against direct contact with live parts is better than that indicated by the first numeral (e.g. IP 20C).

Any characteristic numeral which is unspecified is replaced by an X (e.g. IP XXB).

#### 1<sup>st</sup> characteristic numeral:





corresponds to protection of the equipment against penetration of solid objects and protection of personnel against direct contact with live parts.

#### 2<sup>nd</sup> characteristic numeral:

corresponds to protection of the equipment against penetration of water with harmful effects.

#### Additional letter:

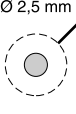
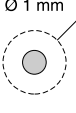
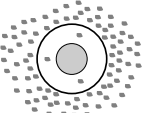
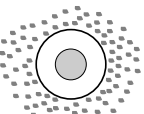
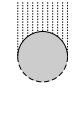
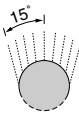
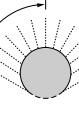
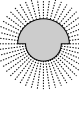
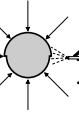
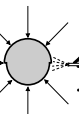
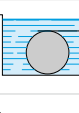
corresponds to protection of personnel against direct contact with live parts.

Protection of the equipment		Protection of personnel	
<b>0</b>	Non-protected	Non-protected	
<b>1</b>	 Protected against the penetration of solid objects having a diameter greater than or equal to 50 mm.	Protected against direct contact with the back of the hand (accidental contacts).	
<b>2</b>	 Protected against the penetration of solid objects having a diameter greater than or equal to 12.5 mm.	Protected against direct finger contact.	
<b>3</b>	 Protected against the penetration of solid objects having a diameter greater than or equal to 2.5 mm.	Protected against direct contact with a Ø 2.5 mm tool.	
<b>4</b>	 Protected against the penetration of solid objects having a diameter greater than or equal to 1 mm.	Protected against direct contact with a Ø 1 mm wire.	
<b>5</b>	 Dust protected (no harmful deposits).	Protected against direct contact with a Ø 1 mm wire.	
<b>6</b>	 Dust tight.	Protected against direct contact with a Ø 1 mm wire.	
<b>0</b>	Non-protected		<b>A</b> With the back of the hand.
<b>1</b>	 Protected against vertical dripping water, (condensation).		<b>B</b> With the finger.
<b>2</b>	 Protected against dripping water at an angle of up to 15°.		<b>C</b> With a Ø 2.5 mm tool.
<b>3</b>	 Protected against rain at an angle of up to 60°.		<b>D</b> With a Ø 1 mm wire.
<b>4</b>	 Protected against splashing water in all directions.		
<b>5</b>	 Protected against water jets in all directions.		
<b>6</b>	 Protected against powerful jets of water and waves.		
<b>7</b>	 Protected against the effects of temporary immersion.		
<b>8</b>	 Protected against the effects of prolonged immersion under specified conditions.		

# Technical information

## Degrees of protection provided by enclosures IK code

### Degrees of protection against mechanical impact

The European standard EN 50102 dated March 1995 defines a coding system (IK code) for indicating the degree of protection provided by electrical equipment enclosures against external mechanical impact.

Standard NF C 15-100 (May 1991 edition), section 512, table 51 A, provides a cross-reference between the various degrees of protection and the environmental conditions classification, relating to the selection of equipment according to external factors.

Practical guide UTE C 15-103 shows, in the form of tables, the characteristics required for electrical equipment (including minimum degrees of protection), according to the locations in which they are installed.

### IK ●● code

The IK code comprises **2 characteristic numerals** (e.g. **IK 05**).

### 2 characteristic numerals:

corresponding to a value of impact energy.

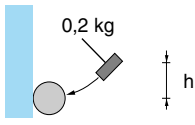
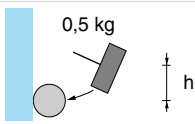
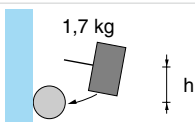
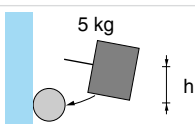
		h (cm)	Energy (J)
<b>00</b>	Non-protected		
<b>01</b>		7.5	0.15
<b>02</b>		10	0.2
<b>03</b>		17.5	0.35
<b>04</b>		25	0.5
<b>05</b>		35	0.7
<b>06</b>		20	1
<b>07</b>		40	2
<b>08</b>		30	5
<b>09</b>		20	10
<b>10</b>		40	20

<b>A</b>					
AB1FU10135U	128	XS1M30KP340D	64	XS1N30NB349D	74
		XS1M30KPM40	121	XS1N30NC410	62
		XS1M30KPM40LD	121	XS1N30NC410D	62
<b>X</b>		XS1M30MA250	60	XS1N30PA349	74
XS1L04NA310S	76	XS1M30MA250K	60	XS1N30PA349D	74
XS1L04NA311	76	XS1M30MB250	60	XS1N30PB349	74
XS1L04NA311S	76	XS1M30MB250K	60	XS1N30PB349D	74
XS1L04NB310	76	XS1M30PAW01D	117	XS1N30PC410	62
XS1L04NB310S	76	XS1N05NA310	76	XS1N30PC410D	62
XS1L04NB311	76	XS1N05NA311	76	XS2L2SANAL2	98
XS1L04NB311S	76	XS1N05NA311S	76	XS2L2SANAM12	98
XS1L04PA310	76	XS1N05NB310	76	XS2L2SAPAL2	98
XS1L04PA310S	76	XS1N05NB311	76	XS2L2SAPAM12	98
XS1L04PA311	76	XS1N05NB311S	76	XS2L06NA340	76
XS1L04PA311S	76	XS1N05PA310	76	XS2L06NA340D	76
XS1L04PB310	76	XS1N05PA311	76	XS2L06NA340S	76
XS1L04PB310S	76	XS1N05PA311S	76	XS2L06NB340	76
XS1L04PB311	76	XS1N05PB310	76	XS2L06NB340D	76
XS1L04PB311S	76	XS1N05PB311	76	XS2L06NB340S	76
XS1L06NA349	74	XS1N05PB311S	76	XS2L06PA340	76
XS1L06NA349D	74	XS1N08NA349	74	XS2L06PA340D	76
XS1L06NA349S	74	XS1N08NA349D	74	XS2L06PA340S	76
XS1L06NB349	74	XS1N08NA349S	74	XS2L06PB340	76
XS1L06NB349S	74	XS1N08NB349	74	XS2L06PB340D	76
XS1L06NC410	62	XS1N08NB349D	74	XS2L06PB340S	76
XS1L06PA349	74	XS1N08NB349S	74	XS2M08NC410	62
XS1L06PA349D	74	XS1N08PA349	74	XS2M08NC410D	62
XS1L06PA349S	74	XS1N08PA349D	74	XS2M08PC410	62
XS1L06PB349	74	XS1N08PA349S	74	XS2M08PC410D	62
XS1L06PB349S	74	XS1N08PB349	74	XS2M12KP340	64
XS1L06PC410	62	XS1N08PB349D	74	XS2M12KP340D	64
XS1M08NC410	62	XS1N08PB349S	74	XS2M12MA250	60
XS1M08NC410D	62	XS1N12NA349	74	XS2M12MA250K	60
XS1M08PC410	62	XS1N12NA349D	74	XS2M12MB250	60
XS1M08PC410D	62	XS1N12NB349	74	XS2M12PAW01D	117
XS1M12AB120	87	XS1N12NB349D	74	XS2M18KP340	64
XS1M12KP340	64	XS1N12NC410	62	XS2M18KP340D	64
XS1M12KP340D	64	XS1N12NC410D	62	XS2M18MA230	66
XS1M12MA250	60	XS1N12PA349	74	XS2M18MA230K	66
XS1M12MA250K	60	XS1N12PA349D	74	XS2M18MA250	60
XS1M12MB250	60	XS1N12PB349	74	XS2M18MA250K	60
XS1M12MB250K	60	XS1N12PB349D	74	XS2M18MB250	60
XS1M12PAW01D	116	XS1N12PC410	62	XS2M18MB250K	60
XS1M18AB120	88	XS1N12PC410D	62	XS2M30KP340	64
XS1M18KP340	64	XS1N18NA349	74	XS2M30KP340D	64
XS1M18KP340D	64	XS1N18NA349D	74	XS2M30MA250	60
XS1M18KPM40	120	XS1N18NA349D	74	XS2M30MA250K	60
XS1M18KPM40D	120	XS1N18NB349	74	XS2M30MB250	60
XS1M18MA250	60	XS1N18NB349D	74	XS2M30MB250K	60
XS1M18MA250K	60	XS1N18NC410	62	XS2N12NC410	62
XS1M18MB250	60	XS1N18NC410D	62	XS2N12NC410D	62
XS1M18MB250K	60	XS1N18PA349	74	XS2N12PC410	62
XS1M18PAS20	126	XS1N18PA349D	74	XS2N12PC410D	62
XS1M18PAS20D	127	XS1N18PB349	74	XS2N18NC410	62
XS1M18PAS40	126	XS1N18PB349D	74	XS2N18NC410D	62
XS1M18PAS40D	127	XS1N18PB349S	74	XS2N18PC410	62
XS1M18PAW01D	116	XS1N18PC410	62	XS2N18PC410D	62
XS1M30AB120	89	XS1N18PC410D	62	XS2N30NC410	62
XS1M30KP340	64	XS1N30NA349	74	XS2N30NC410D	62
		XS1N30NA349D	74	XS2N30PC410	62
		XS1N30NB349	74	XS2N30PC410D	62
				XS4P08MA230	66
				XS4P08MA230K	66
				XS4P08MB230	66
				XS4P08MB230K	66
				XS4P08NA340	66
				XS4P08NA370	66
				XS4P08NB340	66
				XS4P08NB370	66
				XS4P08PA340	66
				XS4P08PA370	66
				XS4P08PB340	66
				XS4P12AB110	87
				XS4P12AB120	87
				XS4P12KP340	64
				XS4P12KP340D	64
				XS4P12MA230	66
				XS4P12MA230K	66
				XS4P12MB230	66
				XS4P12MB230K	66
				XS4P12NA340	66
				XS4P12NA370	66
				XS4P12NB340	66
				XS4P12NB370	66
				XS4P12PA340	66
				XS4P12PA370	66
				XS4P12PB340	66
				XS4P12PB370	66
				XS4P18AB110	88
				XS4P18AB120	88
				XS4P18KP340	64
				XS4P18KP340D	64
				XS4P18MA230	66
				XS4P18MA230K	66
				XS4P18MB230	66
				XS4P18MB230K	66
				XS4P18NA340	66
				XS4P18NA370	66
				XS4P18NB340	66
				XS4P18NB370	66
				XS4P18PA340	66
				XS4P18PA370	66
				XS4P18PB340	66
				XS4P18PB370	66
				XS4P30AB110	89
				XS4P30AB120	89
				XS4P30KP340	64
				XS4P30KP340D	64
				XS4P30MA230	66
				XS4P30MA230K	66
				XS4P30MB230	66
				XS4P30MB230K	66
				XS4P30NA340	66
				XS4P30NA370	66
				XS4P30NB340	66
				XS4P30NB370	66
				XS4P30PA340	66
				XS4P30PA370	66
				XS4P30PB340	66
				XS4P30PB370	66
				XS4P30PB370	66
				XS7C1A1CAL01M12	48
				XS7C1A1CAL08M12	48
				XS7C1A1DAL01M12	48
				XS7C1A1DAL2	48
				XS7C1A1DAM8	48
				XS7C1A1DBL01M12	48
				XS7C1A1DBL2	48
				XS7C1A1DBM8	48
				XS7C1A1NAL01M12	48
				XS7C1A1NAL2	48
				XS7C1A1NAM8	48
				XS7C1A1NBL01M12	48
				XS7C1A1NBL2	48
				XS7C1A1NBM8	48
				XS7C1A1PAL01M12	48
				XS7C1A1PAL2	48
				XS7C1A1PAM8	48
				XS7C1A1PBL01M12	48
				XS7C1A1PBL2	48
				XS7C1A1PBM8	48
				XS7C40DA210	54
				XS7C40DP210	54
				XS7C40FP260	56
				XS7C40KPM40	124
				XS7C40MP230	56
				XS7C40NC440	54
				XS7C40NC449	54
				XS7C40PC440	54
				XS7C40PC449	54
				XS7D1A1CAM12	48
				XS7D1A1DAL2	48
				XS7D1A1DAM12	48
				XS7D1A1DBL2	48
				XS7D1A1DBM12	48
				XS7D1A1NAL2	48
				XS7D1A1NBL2	48
				XS7D1A1NBM12	48
				XS7D1A1PAL2	48
				XS7D1A1PAM12	48
				XS7D1A1PBL2	48
				XS7D1A1PBM12	48
				XS7D1A3CAM12DIN	112
				XS7E1A1CAL01M12	48
				XS7E1A1CAL08M12	48
				XS7E1A1DAL01M12	48
				XS7E1A1DAL2	48
				XS7E1A1DAM8	48
				XS7E1A1DBL01M12	48
				XS7E1A1DBL2	48
				XS7E1A1DBM8	48
				XS7E1A1NAL01M12	48
				XS7E1A1NAL2	48
				XS7E1A1NAM8	48
				XS7E1A1NBL01M12	48
				XS7E1A1NBL2	48
				XS7E1A1NBM8	48
				XS7E1A1PAL01M12	48

XS7E1A1PAL2	48	XS8C1A1PBM8	80	XS9D111A1L2	91	XS112B3NAL2TQ	34	XS130BLPAM12	71
XS7E1A1PAM8	48	XS8C40DA210	54	XS9D111A1M12	91	XS112B3NAM12	34	XS130BLPBL2	71
XS7E1A1PBL01M12	48	XS8C40DP210	54	XS9D111A2L2	93	XS112B3NAM12TQ	34	XS130BLPBM12	71
XS7E1A1PBL2	48	XS8C40FP260	56	XS9D111A2M12	93	XS112B3NBL2	34	XS208ALNAL2	68
XS7E1A1PBM8	48	XS8C40MP230	56	XS9E111RMBL01U20	85	XS112B3NBM12	34	XS208ALNBL2	68
XS7F1A1DAL01M8	46	XS8C40NC440	54	XS9E111RPBL01M12	85	XS112B3PAL2	34	XS208ALPAL2	68
XS7F1A1DAL2	46	XS8C40NC449	54	XS9E111A1L01M12	91	XS112B3PAL2TQ	34	XS208ALPBL2	68
XS7F1A1DBL01M8	46	XS8C40PC440	54	XS9E111A1L2	91	XS112B3PAM12	34	XS208BLNAL2	70
XS7F1A1DBL2	46	XS8C40PC449	54	XS9E111A2L01M12	93	XS112B3PAM12TQ	34	XS208BLNAM8	70
XS7F1A1NAL01M8	46	XS8D1A1MAL2	80	XS9E111A2L2	93	XS112B3PBL2	34	XS208BLNAM12	70
XS7F1A1NAL2	46	XS8D1A1MAU20	80	XS9F111A1L01M8	91	XS112B3PBM12	34	XS208BLNBL2	70
XS7F1A1NBL01M8	46	XS8D1A1MBL2	80	XS9F111A1L2	91	XS112B3PBM12TQ	34	XS208BLNBM8	70
XS7F1A1NBL2	46	XS8D1A1MBU20	80	XS9F111A2L01M8	93	XS112BLFAL2	70	XS208BLNBM12	70
XS7F1A1PAL01M8	46	XS8D1A1NAL2	80	XS9F111A2L2	93	XS112BLNAL2	70	XS208BLPAL2	70
XS7F1A1PAL2	46	XS8D1A1NAM12	80	XS106B3NAL2	34	XS112BLNAM12	70	XS208BLPAM8	70
XS7F1A1PBL01M8	46	XS8D1A1NBL2	80	XS106B3NAM8	34	XS112BLNBL2	70	XS208BLPAM12	70
XS7F1A1PBL2	46	XS8D1A1NBM12	80	XS106B3NBL2	34	XS112BLNBM12	70	XS208BLPBL2	70
XS7G12MA230	110	XS8D1A1PAL2	80	XS106B3NBM8	34	XS112BLPAL2	70	XS208BLPBM8	70
XS7G12MB230	110	XS8D1A1PAM12	80	XS106B3PAL2	34	XS112BLPAM12	70	XS208BLPBM12	70
XS7G12NA140	108	XS8D1A1PBL2	80	XS106B3PAL2TQ	34	XS112BLPBL2	70	XS212AANAL2	102
XS7G12NA140S	108	XS8D1A1PBM12	80	XS106B3PAM8	34	XS112BLPBM12	70	XS212AANAM12	102
XS7G12NC440	108	XS8E1A1MAL01U20	80	XS106B3PAM8TQ	34	XS118B3NAL2	35	XS212AAPAL2	102
XS7G12PA140	108	XS8E1A1MAL2	80	XS106B3PAM12	34	XS118B3NAL2TQ	35	XS212AAPAM12	102
XS7G12PA140S	108	XS8E1A1MBL01U20	80	XS106B3PBL2	34	XS118B3NAM12	35	XS212ALNAL2	68
XS7G12PC440	108	XS8E1A1MBL2	80	XS106B3PBM8	34	XS118B3NAM12TQ	35	XS212ALNAM12	68
XS7J1A1DAL01M8	46	XS8E1A1NAL01M12	80	XS106BLNAL2	70	XS118B3NBL2	35	XS212ALNBL2	68
XS7J1A1DAL2	46	XS8E1A1NAL2	80	XS106BLNBL2	70	XS118B3NBM12	35	XS212ALNBM12	68
XS7J1A1DBL01M8	46	XS8E1A1NAM8	80	XS106BLPAL2	70	XS118B3PAL2	35	XS212ALPAL2	68
XS7J1A1DBL2	46	XS8E1A1NBL01M12	80	XS106BLPBL2	70	XS118B3PAL2TQ	35	XS212ALPAM12	68
XS7J1A1NAL01M8	46	XS8E1A1NBL2	80	XS108B3NAL2	34	XS118B3PAM12	35	XS212ALPBL2	68
XS7J1A1NAL2	46	XS8E1A1NBM8	80	XS108B3NAL2TQ	34	XS118B3PAM12TQ	35	XS212ALPBM12	68
XS7J1A1NBL01M8	46	XS8E1A1PAL01M12	80	XS108B3NAM8	34	XS118B3PBL2	35	XS212BLNAL2	70
XS7J1A1NBL2	46	XS8E1A1PAL2	80	XS108B3NAM8TQ	34	XS118B3PBM12	35	XS212BLNAM12	70
XS7J1A1PAL01M8	46	XS8E1A1PAM8	80	XS108B3NAM12	34	XS118BLFAL2	71	XS212BLNBL2	70
XS7J1A1PAL2	46	XS8E1A1PBL01M12	80	XS108B3NBL2	34	XS118BLNAL2	71	XS212BLNBM12	70
XS7J1A1PBL01M8	46	XS8E1A1PBL2	80	XS108B3NBM8	34	XS118BLNAM12	71	XS212BLPAL2	70
XS7J1A1PBL2	46	XS8E1A1PBM8	80	XS108B3NBM12	34	XS118BLNBL2	71	XS212BLPAM12	70
XS7T4DA210	58	XS8G12MA230	110	XS108B3PAL2	34	XS118BLNBM12	71	XS212BLPBL2	70
XS7T4DA214LD	58	XS8G12MB230	110	XS108B3PAL2TQ	34	XS118BLPAL2	71	XS212BLPBM12	70
XS7T4DA214LD01	58	XS8G12NA140	108	XS108B3PAM8	34	XS118BLPAM12	71	XS212SANAL2	98
XS7T4NC440	58	XS8G12NA140S	108	XS108B3PAM8TQ	34	XS118BLPBL2	71	XS212SANAM12	98
XS7T4NC440LD	58	XS8G12NC440	108	XS108B3PAM12	34	XS118BLPBM12	71	XS212SAPAL2	98
XS7T4PC440	58	XS8G12PA140	108	XS108B3PAM12TQ	34	XS130B3NAL2	35	XS212SAPAM12	98
XS7T4PC440LD	58	XS8G12PA140S	108	XS108B3PBL2	34	XS130B3NAM12	35	XS218AAMAL2	104
XS8C1A1MAL01U20	80	XS8G12PC440	108	XS108B3PBM8	34	XS130B3NAM12TQ	35	XS218AAMAU20	104
XS8C1A1MAL2	80	XS8T4NC440	58	XS108B3PBM12	34	XS130B3NBL2	35	XS218AANAL2	102
XS8C1A1MBL01U20	80	XS8T4NC440LD	58	XS108BLNAL2	70	XS130B3NBM12	35	XS218AANAM12	102
XS8C1A1MBL2	80	XS8T4PC440	58	XS108BLNAM8	70	XS130B3PAL2	35	XS218AAPAL2	102
XS8C1A1NAL01M12	80	XS8T4PC440LD	58	XS108BLNAM12	70	XS130B3PAL2TQ	35	XS218AAPAM12	102
XS8C1A1NAL2	80	XS9C2A1NCM12	122	XS108BLNBL2	70	XS130B3PAM12	35	XS218ALNAL2	68
XS8C1A1NAM8	80	XS9C2A1PCM12	122	XS108BLNBM8	70	XS130B3PAM12TQ	35	XS218ALNAM12	68
XS8C1A1NBL01M12	80	XS9C4A1NCP20	122	XS108BLNBM12	70	XS130B3PBL2	35	XS218ALNBL2	68
XS8C1A1NBL2	80	XS9C4A1PCP20	122	XS108BLPAL2	70	XS130B3PBM12	35	XS218ALNBM12	68
XS8C1A1NBM8	80	XS9C111RMBL01U20	85	XS108BLPAM8	70	XS130BLFAL2	71	XS218ALPAL2	68
XS8C1A1PAL01M12	80	XS9C111RPBL01M12	85	XS108BLPAM12	70	XS130BLNAL2	71	XS218ALPAM12	68
XS8C1A1PAL2	80	XS9C111A1L01M12	91	XS108BLPBL2	70	XS130BLNAM12	71	XS218ALPBL2	68
XS8C1A1PAM8	80	XS9C111A1L2	91	XS108BLPBM8	70	XS130BLNBL2	71	XS218ALPBM12	68
XS8C1A1PBL01M12	80	XS9C111A2L01M12	93	XS108BLPBM12	70	XS130BLNBM12	71	XS218BLNAL2	71
XS8C1A1PBL2	80	XS9C111A2L2	93	XS112B3NAL2	34	XS130BLPAL2	71	XS218BLNAM12	71



XS218BLNBL2	71	XS508B1DAM12	29	XS512BSDAL2	28	XS530B1NAM12	24	XS612B2NAL01M12	78
XS218BLNBM12	71	XS508B1DBL2	29	XS512BSDAM12	28	XS530B1NBL2	24	XS612B2NBL01M12	78
XS218BLPAL2	71	XS508B1DBM12	29	XS512BSDBL2	28	XS530B1NBM12	24	XS612B2PAL01M12	78
XS218BLPAM12	71	XS508B1NAL2	24	XS512BSDBM12	28	XS530B1PAL2	24	XS612B2PBL01M12	78
XS218BLPBL2	71	XS508B1NAM8	24	XS518B1CAL08M12	29	XS530B1PAM12	24	XS612B3DAL2	38
XS218BLPBM12	71	XS508B1NAM12	24	XS518B1CAM12	29	XS530B1PBL2	24	XS612B3DAM12	38
XS218SAMAL2	100	XS508B1NBL2	24	XS518B1DAL01B	29	XS530B1PBM12	24	XS612B3DBL2	38
XS218SAMAU20	100	XS508B1NBM8	24	XS518B1DAL01C	29	XS530BLNAL2	25	XS612B3DBM12	38
XS218SANAL2	98	XS508B1NBM12	24	XS518B1DAL01G	29	XS530BLNAM12	25	XS612B4NAL2	42
XS218SANAM12	98	XS508B1PAL2	24	XS518B1DAL2	29	XS530BLNBL2	25	XS612B4NAM12	42
XS218SAPAL2	98	XS508B1PAM8	24	XS518B1DAL2TF	29	XS530BLNBM12	25	XS612B4NBL2	42
XS218SAPAM12	98	XS508B1PAM12	24	XS518B1DAM12	29	XS530BLPAL2	25	XS612B4NBM12	42
XS230AAMAL2	104	XS508B1PBL2	24	XS518B1DBL01B	29	XS530BLPAM12	25	XS612B4PAL2	42
XS230AAMAU20	104	XS508B1PBM8	24	XS518B1DBL2	29	XS530BLPBL2	25	XS612B4PAM12	42
XS230AANAL2	102	XS508B1PBM12	24	XS518B1DBL08M12	29	XS530BLPBM12	25	XS612B4PBL2	42
XS230AANAM12	102	XS508BLNAL2	25	XS518B1DBM12	29	XS530BSCAL08M12	28	XS612B4PBM12	42
XS230AAPAL2	102	XS508BLNAM12	25	XS518B1MAL2	32	XS530BSCAM12	28	XS618B1DAL2	38
XS230AAPAM12	102	XS508BLNBL2	25	XS518B1MAU20	32	XS530BSDAL2	28	XS618B1DAM12	38
XS230ALNAL2	68	XS508BLNBM12	25	XS518B1MBL2	32	XS530BSDAM12	28	XS618B1DBL2	38
XS230ALNAM12	68	XS508BLPAL2	25	XS518B1MBU20	32	XS530SDBL2	28	XS618B1DBM12	38
XS230ALNBL2	68	XS508BLPAM12	25	XS518B1NAL2	24	XS530SDBM12	28	XS618B1MAL01B	40
XS230ALNBM12	68	XS508BLPBL2	25	XS518B1NAM12	24	XS606B1DAL2	38	XS618B1MAL01C	40
XS230ALPAL2	68	XS508BLPBM12	25	XS518B1NBL2	24	XS606B1DBL2	38	XS618B1MAL01G	40
XS230ALPAM12	68	XS508BSCAL01M12	28	XS518B1NBM12	24	XS606B3CAL01M12	38	XS618B1MAL2	40
XS230ALPBL2	68	XS508BSCAL2	28	XS518B1PAL2	24	XS606B3CAL2	38	XS618B1MAU20	40
XS230ALPBM12	68	XS508BSCAL08M12	28	XS518B1PAM12	24	XS606B3CBL2	38	XS618B1MBL01B	40
XS230BLNAL2	71	XS508BSCBL01M12	28	XS518B1PBL2	24	XS608B1DAL2	38	XS618B1MBL01C	40
XS230BLNAM12	71	XS508BSCBL2	28	XS518B1PBM12	24	XS608B1DAM12	38	XS618B1MBL01G	40
XS230BLNBL2	71	XS512B1CAL08M12	29	XS518BLNAL2	25	XS608B1DBL2	38	XS618B1MBL2	40
XS230BLNBM12	71	XS512B1CAM12	29	XS518BLNAM12	25	XS608B1DBM12	38	XS618B1MBU20	40
XS230BLPAL2	71	XS512B1DAL2	29	XS518BLNBL2	25	XS608B1NAL2	36	XS618B1NAL01B	36
XS230BLPAM12	71	XS512B1DAL08U78	29	XS518BLNBM12	25	XS608B1NAM12	36	XS618B1NAL01C	36
XS230BLPBL2	71	XS512B1DAM12	29	XS518BLPAL2	25	XS608B1NBL2	36	XS618B1NAL2	36
XS230BLPBM12	71	XS512B1DBL2	29	XS518BLPAM12	25	XS608B1NBM12	36	XS618B1NAM12	36
XS230SAMAL2	100	XS512B1DBL08M12	29	XS518BLPBL2	25	XS608B1PAL2	36	XS618B1NBL01B	36
XS230SAMAU20	100	XS512B1DBM12	29	XS518BLPBM12	25	XS608B1PAM12	36	XS618B1NBL01C	36
XS230SANAL2	98	XS512B1MAL2	32	XS518BSCAL08M12	28	XS608B1PBL2	36	XS618B1NBL2	36
XS230SANAM12	98	XS512B1MAU20	32	XS518BSCAM12	28	XS608B1PBM12	36	XS618B1NBM12	36
XS230SAPAL2	98	XS512B1MBL2	32	XS518BSDAL2	28	XS608B3CAL01M12	38	XS618B1PAL01B	36
XS230SAPAM12	98	XS512B1MBU20	32	XS518BSDAM12	28	XS608B3CAL2	38	XS618B1PAL01C	36
XS506B1NAL2	24	XS512B1NAL2	24	XS518BSDBL2	28	XS608B3CBL01M12	38	XS618B1PAL01G	36
XS506B1NAM8	24	XS512B1NAM12	24	XS518BSDBM12	28	XS608B3CBL2	38	XS618B1PAL2	36
XS506B1NBL2	24	XS512B1NBL2	24	XS530B1CAL08M12	29	XS612B1DAL2	38	XS618B1PAM12	36
XS506B1NBM8	24	XS512B1NBM12	24	XS530B1CAM12	29	XS612B1DAM12	38	XS618B1PBL01B	36
XS506B1PAL2	24	XS512B1PAL2	24	XS530B1DAL01B	29	XS612B1DBL2	38	XS618B1PBL01C	36
XS506B1PAM8	24	XS512B1PAM12	24	XS530B1DAL01C	29	XS612B1DBM12	38	XS618B1PBL2	36
XS506B1PAM12	24	XS512B1PBL2	24	XS530B1DAL01G	29	XS612B1MAL2	40	XS618B1PBM12	36
XS506B1PBL2	24	XS512B1PBM12	24	XS530B1DAL2	29	XS612B1MAU20	40	XS618B2NAL01M12	78
XS506B1PBM8	24	XS512BLNAL2	25	XS530B1DAL2TF	29	XS612B1MBL2	40	XS618B2NBL01M12	78
XS506BLNAL2	25	XS512BLNAM12	25	XS530B1DAM12	29	XS612B1MBU20	40	XS618B2PAL01M12	78
XS506BLPAL2	25	XS512BLNBL2	25	XS530B1DBL01B	29	XS612B1NAL2	36	XS618B2PBL01M12	78
XS506BSCAL01M12	28	XS512BLNBM12	25	XS530B1DBL2	29	XS612B1NAM12	36	XS618B3DAL2	38
XS506BSCAL2	28	XS512BLPAL2	25	XS530B1DBM12	29	XS612B1NBL2	36	XS618B3DAM12	38
XS506BSCBL2	28	XS512BLPAM12	25	XS530B1MAL2	32	XS612B1NBM12	36	XS618B3DBL2	38
XS508B1CAL08M12	29	XS512BLPBL2	25	XS530B1MAU20	32	XS612B1PAL2	36	XS618B3DBM12	38
XS508B1CAM12	29	XS512BLPBM12	25	XS530B1MBL2	32	XS612B1PAM12	36	XS618B4MAL2	44
XS508B1DAL2	29	XS512BSCAL08M12	28	XS530B1MBU20	32	XS612B1PBL2	36	XS618B4MAU20	44
XS508B1DAL08M12	29	XS512BSCAM12	28	XS530B1NAL2	24	XS612B1PBM12	36	XS618B4MBL2	44

XS618B4MBU20	44	XS908R4PAM12	106	XSZB118	24	XSZE218	128
XS618B4NAL2	42	XS908R4PAM12	107		25	XSZE230	128
XS618B4NAM12	42	XS912R1PAM12	106		28	XSZE308	128
XS618B4NBL2	42	XS912R1PAM12	107		29	XSZE312	128
XS618B4NBM12	42	XS912R4PAM12	106		32	XSZE318	128
XS618B4PAL2	42	XS912R4PAM12	107		35	XSZE330	128
XS618B4PAM12	42	XS912RWPAM12	114		36	XSZF10	128
XS618B4PBL2	42	XS912RWPAM12	115		38	XSZP112	128
XS618B4PBM12	42	XS912S1PAM12	96		40	XSZP118	128
XS630B1DAL2	38	XS912S1PAM12	97		42	XSZP130	128
XS630B1DAM12	38	XS912S4PAM12	96		44	XSZPE13	128
XS630B1DBL2	38	XS912S4PAM12	97		60	XSZPKC2	123
XS630B1DBM12	38	XS918R1PAM12	106		62	XSZPSC2	123
XS630B1MAL01B	40	XS918R1PAM12	107		64	XSZVF03	128
XS630B1MAL01C	40	XS918R4PAM12	106		68	XSZVF04	128
XS630B1MAL01G	40	XS918R4PAM12	107	XSZB130	71	XSZVF05	128
XS630B1MAL2	40	XS918RWPAM12	114		74	XTAZ30	128
XS630B1MAU20	40	XS918RWPAM12	115		78	XUZA118	96
XS630B1MBL01B	40	XS918S1PAM12	96		102		98
XS630B1MBL01C	40	XS918S1PAM12	97		104		100
XS630B1MBL01G	40	XS918S4PAM12	96		128	XUZB32	128
XS630B1MBL2	40	XS918S4PAM12	97			XUZB2005	98
XS630B1MBU20	40	XS930R1PAM12	106			XUZE04	128
XS630B1NAL01B	36	XS930R1PAM12	107			XUZE06	128
XS630B1NAL01C	36	XS930R4PAM12	106			XUZE08	128
XS630B1NAL2	36	XS930R4PAM12	107			XZCP1141L2	106
XS630B1NAM12	36	XS930S1PAM12	96				114
XS630B1NBL01B	36	XS930S1PAM12	97			XZCP1141L5	106
XS630B1NBL01C	36	XS930S4PAM12	96				114
XS630B1NBL2	36	XS930S4PAM12	97			XZCP1141L10	106
XS630B1NBM12	36	XSAV11373	83	XSZB165	24		114
XS630B1PAL01B	36	XSAV11801	83		25	XZCP1241L2	106
XS630B1PAL01C	36	XSAV12373	83		28		114
XS630B1PAL01G	36	XSAV12801	83		35	XZCP1241L5	106
XS630B1PAL2	36	XSCZ01	128		38		114
XS630B1PAM12	36	XSZA020	128		71	XZCP1241L10	106
XS630B1PBL01B	36	XSZA034	128		74		114
XS630B1PBL01C	36	XSZB104	128	XSZBC00	128	XZCPA1141L2	96
XS630B1PBL01G	36	XSZB105	128	XSZBC10	128		98
XS630B1PBL2	36	XSZB108	24	XSZBC90	128		102
XS630B1PBM12	36		25	XSZBD10	128	XZCPA1141L5	96
XS630B2NAL01M12	78		28	XSZBE00	128		98
XS630B2NBL01M12	78		29	XSZBE10	128	XZCPA1141L10	96
XS630B2PAL01M12	78		35	XSZBE90	128		98
XS630B2PBL01M12	78		36	XSZBF00	128		102
XS630B3DAL2	38		38	XSZBF90	128	XZCPA1241L2	96
XS630B3DAM12	38		62	XSZBJ00	128		98
XS630B3DBL2	38		68	XSZBJ90	128		102
XS630B3DBM12	38		71	XSZBPM12	78	XZCPA1241L5	96
XS630B4MAL2	44	XSZB112	24		85		98
XS630B4MAU20	44		25		128	XZCPA1241L10	96
XS630B4MBL2	44		28	XSZBS12	96		98
XS630B4MBU20	44		29		98	XZCPA1865L5	100
XS630B4NAL2	42		32		96		104
XS630B4NAM12	42		35	XSZBS30	96	XZCPA1865L10	100
XS630B4NBL2	42		36		98		104
XS630B4NBM12	42		38		100	XZCPA1965L5	100
XS630B4PAL2	42		40	XSZE105	128		104
XS630B4PAM12	42		42	XSZE108	128	XZCPA1965L10	100
XS630B4PBL2	42		60	XSZE112	128		104
XS630B4PBM12	42		62	XSZE118	128	XZCPA151140A2	98
XS908R1PAM12	106		64	XSZE130	128		102
XS908R1PAM12	107		68	XSZE208	128	XZCPA151140A5	98
			78	XSZE212	128		102
			102				
			106				
			128				



**Telemecanique Sensors USA**

1875 Founders Dr.  
Dayton, OH 45420-4017  
TEL: 888-778-2733

[www.tesensors.us](http://www.tesensors.us)

**Telemecanique Sensors Canada**

5985 McLaughlin Road  
Mississauga, Ontario L5R 1B8  
TEL: 800-565-6699

[www.tesensors.ca](http://www.tesensors.ca)

The information provided in this documentation contains general descriptions and/or technical characteristics of the performance of the products contained herein. This documentation is not intended as a substitute for and is not to be used for determining suitability or reliability of these products for specific user applications. It is the duty of any such user or integrator to perform the appropriate and complete risk analysis, evaluation and testing of the products with respect to the relevant specific application or use thereof. Neither Schneider Electric nor any of its affiliates or subsidiaries shall be responsible or liable for misuse of the information contained herein.